



GLOBAL SUPPLIER QUALITY HANDBOOK

Rev. 6, October 2024

CONTENTS

A message from our executives	4
Overview	5
Existing and potential suppliers	5
Our Core Values	6
Corporate Social Responsibility (CSR)	7
Social responsibility & ethics	7
Environmental, Social & Governance (ESG).....	7
Human rights	7
Responsible Business Alliance.....	7
Avnet’s conflict minerals policy.....	7
Ethics Alert Line.....	8
Avnet global quality policy	8
Avnet environmental policy.....	8
Supply chain expectations	8
Avnet supply chain Code of Conduct	8
Avnet Supply Chain Due Diligence.....	8
Avnet corporate citizenship	9
Suspected Unapproved Parts (SUP) incl. counterfeit mitigation.....	9
Non-disclosure agreements.....	9
Contractual flow down / terms and conditions.....	9
General expectations – Avnet’s customer requirements	10
Customer requirements	10
DPAS rated purchase orders.....	10
Avnet identification/labels	10
Our goal, operational excellence	10
Supplier communication	11
Classifying our supply chain.....	11
Subcontractors: value add services:.....	11
Supply chain approval status.....	11
Supply chain performance.....	12
Supplier On-Time Delivery (OTD)	12
Performance reviews	12
Process improvement program	12
Supplier Corrective Action Requests (SCAR) / Technical Failure Analysis Request (FAR).....	13
Supplier Improvement Request (SIR)	13
In-Process Failures (IPF)	13
Subcontracting.....	14
Hold harmless agreement	14
Business interruption plan	14

Corrective action..... 14

Military-rated orders..... 14

Engineering Change Notification (ECN), Product Change Notice (PCN), End-of-Life (EOL), Product Discontinuance Notice (PDN), Product Termination Notice (PTN) 14

Change notification data requirements..... 15

Product alerts and recalls 15

Audits 16

Product quality 16

Product and packing material compliance..... 17

Environmental requirements 18

Appendix I Avnet US / Avnet Asia 19

Appendix II Avnet EMEA 26

Revision history of Avnet Global Supplier Quality Manual 39

A message from our executives

Welcome to the “Avnet Inc. (and all subsidiaries under its control) Supplier Quality Handbook.”

This handbook is designed to acquaint potential and existing partners within the Avnet supply chain with our company, culture, and our direction for the future concerning supply chain management. “Suppliers” addressed by this Handbook include natural persons and legal entities and their affiliated companies which render supplies or services to Avnet, for example suppliers, consultants, commercial agents, contractors, and other suppliers and intermediaries for goods and services. We expect you take some time to review all sections of this handbook to better understand Avnet as a company, a customer and as a strategic partner for the future.

Avnet is a FORTUNE 500 company that creates value for our shareholders by helping more than one Million customers and the top technology suppliers in 140 countries around the world navigate each phase of the product innovation and technology lifecycle. From idea to design and from prototype to production, Avnet supports customers of all types and sizes at each stage of the product lifecycle, guiding today’s ideas into tomorrow’s technology. With deep expertise in design and engineering, broad line distribution, integration and services, Avnet is uniquely positioned to meet critical time-to-market needs for customers globally.

The challenge we must face together is to continually improve our integrated supply chain by offering our customers competitive solutions around cost, quality, delivery, and our ability to adapt to ever changing customer demands within this competitive global environment. We must respond by offering unparalleled global logistics solutions and strong collaborative partnerships without supply chain and customers alike as a competitive differentiator and competitive advantage.

As our customers continue to raise the bar on our performance, we call on you as our supply chain partners to share in this commitment to excellence. Much of Avnet’s success has been built upon offering our customer’s technology and logistics solutions to meet the ever-changing demands of today’s global markets.

The relationship between Avnet and our supply chain is built on a long history of mutual trust, integrity, and a commitment to operational excellence. We are committed to communicating openly and honestly with our supply chain partners and continue to build positive relationships to extend and widen our competitive advantage.

Thank you for your commitment to a strong, productive, and continually improving partnership.

Overview

This Avnet Global Supplier Quality Handbook serves as a guideline and in some cases a requirement but does not supersede the Terms & Conditions (T&Cs) of existing Supplier contracts. In the event of a conflict between this handbook and a supplier contract, the contract prevails. Any additional, specific requirements or amendments to it may be requested and agreed upon by any Avnet company placing orders at Suppliers within this Handbook's scope. Please take time to review the content and discuss sections with which you are unfamiliar or areas where you may have questions with your Avnet point of contact.

All products and brand names are trademarks or registered trademarks of their respective companies. All logos are the property of their respective owners.

Existing and potential suppliers

This Handbook is designed to inform you about our company, culture, supply chain direction, and general expectations for suppliers, but also cascading our customers' or their business specific requirements for suppliers. Avnet is one of the world's largest electronic components and embedded solutions distributors. The market needs and trends drive Avnet's product and services strategy, supported by a global infrastructure. Avnet brings a breadth and depth of service capabilities, such as supply-chain and design-chain services, logistics solutions, product assembly, device programming, integration, technical seminars, and our core distribution services.

The relationship between Avnet and our supply base is built on mutual trust, integrity, and a history of world-class performance. We select suppliers that share our commitment to conducting business ethically, socially responsibly and with quality. We will expect that of you, and you can expect the same of us. This Handbook outlines those expectations.

Welcome to Avnet!

On behalf of the Executive Leadership Team



Alex Iuorio

Senior Vice President,
Global Supplier Development



Rebeca Obregon

President Global Farnell and
Integrated Solutions



Slobodan Puljarevic

President, Avnet EMEA,
Global Design Chain
& Supplier Management



OUR PURPOSE STATEMENT

Guiding today's ideas into tomorrow's technology

Our Core Values

Core values define who we are as individuals and as a company. Our core values define us to each other, our customers, our shareholders, our suppliers, our competitors, and our communities. Our core values are not just words on paper. We expect to demonstrate these core values in our daily work. We expect these core values to guide us to achieve our Avnet vision.

Integrity

We demonstrate honesty and trustworthiness in all we do with the highest standard of ethical behavior to guide all our actions.

Customer focus

We strive to exceed expectations in every interaction, focused on agile and innovative solutions that positively impact our global communities by creating sustainable operations today and for the future.

Ownership

We are personally responsible and accept full accountability for delivering on our commitments.

Teamwork

We work together across boundaries to delight our customers, suppliers, and employees to help the company win and promote a collaborative culture.

Inclusiveness

We value and respect our people by embracing diversity of backgrounds, learning, experience and thought, creating equal opportunities across our workplace culture.

Corporate Social Responsibility (CSR)

Social responsibility & ethics

Avnet complies with international ethical and legal standards. Therefore, all delivered goods must be produced:

- Lawfully, through fair and honest dealing.
- Without exploiting the people who made them.
- In decent working conditions; and
- Without damaging the environment

Environmental, Social & Governance (ESG)

Avnet's commitment to sustainability is critical to deliver long-term value to our stakeholders. Our ESG key stakeholders include customers, suppliers, investors, communities, employees and government. Across our business, we strive to enhance our positive impacts and minimize negative impacts. Sustainability is an ever-evolving journey, and we are committed to it for the long haul. Our sustainability strategy is anchored in the top three issues identified in our materiality assessment, as follows:

Diversity, Equity & Inclusion (DEI): We prioritize a diverse and inclusive workplace. Our comprehensive approach includes addressing biases in hiring and promotion, enhancing supplier diversity, and supporting underrepresented groups. **Climate change and waste:** Reducing Avnet's greenhouse gas footprint — in and beyond our operations — is the core focus of our environmental strategy. It includes reducing waste from all our activities. **Ethics and compliance:** Our strategy is about doing things right. That's why our set of rules and policies, strong corporate governance system and internal compass guide Avnet culture to go well beyond compliance. You can read more about Avnet's sustainability strategy in our most recent Sustainability Report, located [HERE](#).

Human rights

Avnet values and seeks to uphold basic human rights in all our operations and obligates its supply-chain partners to uphold the same standards. We provide reasonable working hours and fair wages. We do not use or tolerate others' use of forced labor or human trafficking practices, including the exploitation of children. We respect the rights of all workers to right to associate, peaceably assemble and communicate concerns with management without fear of discrimination or harassment. We recognize and respect the rights of all individuals regardless of race, color, ancestry, national origin, gender, gender identity or expression, sexual orientation, religion, age, disability or any other legally protected trait, and do not discriminate against anyone based on the same. We are also taking steps to work toward a conflict-free supply chain. Avnet's responsible sourcing approach incorporates human rights and environmental risk assessments on our supply chain. More information available on our [responsible sourcing page](#) and in [Avnet's Declaration of Principles for Human Rights](#).

Responsible Business Alliance

The [Responsible Business Alliance](#) (RBA) Code of Conduct provides additional clarity about our Labor, Health and Safety, Environmental, Ethics and Management Systems expectations for Suppliers. Avnet expects all Suppliers to comply with the Avnet Supplier Code of Conduct or other codes or policies with substantially the same terms. The Responsible Business Alliance Code of Conduct is available at the Responsible Business Alliance website.

Avnet's conflict minerals policy

All products supplied to Avnet must comply with the essential requirements of the Dodd-Frank Act (US) Section 1502 and the Responsible Business Alliance (RBA) Code. Avnet expects Suppliers to only source materials from environmentally and socially responsible suppliers. You can read more about Avnet's Conflict Minerals and Responsible Sourcing [HERE](#).

Ethics Alert Line

Any Supplier observing or suspecting illegal or unethical activities involving Avnet's business may report the same to Avnet either through their Avnet point of contact or through Avnet's Ethics Alert Line available at <https://avnet.alertline.com>. When using the Ethics Alert line, you are encouraged to identify yourself to assist in effectively addressing concerns. However, where allowed by law, you may choose to remain anonymous. In any case, our company strives to maintain confidentiality, within the limits of the law.

Avnet global quality policy

Each Avnet employee strives to provide products, services and solutions that fully meet or exceed the established requirements of our internal and external customers and is committed to continual improvement.

We achieve this through the process of defining and understanding our customers and key stakeholder requirements. Measurable objectives are established and reviewed at various points within the organization. Avnet is committed to practicing environmentally responsible business processes in the spirit of continual improvement.

All Suppliers must contribute towards achieving and implementing the objectives of the Avnet Global Quality Policy and principles and must promote continual improvement.

Avnet environmental policy

At Avnet, we recognize the importance of conducting business and responsibly managing environmental issues to ensure long term sustainability. We adhere to our Core Values of integrity, Customer Focus, Ownership, Teamwork, and inclusiveness to help ensure that we follow applicable environmental laws and regulations globally. Please also refer to our Global Environmental Policy for further details.

You can read more about Avnet's Environmental, Social and Governance (ESG) Policies [HERE](#).

Supply chain expectations

Avnet requires its supply base to have a quality management system in place that complies with ISO 9001 as a minimum or as defined by specific purchase order and/or contract. Any qualified products and services dedicated for applications in aviation/aerospace, automotive, naval, telecommunications, military or medical equipment logically stipulate their respective business segment's quality standards like IATF16949, EN AS 9100, ISO 13485. A core component in any quality system must be the knowledge, monitoring and continual improvement of key processes. These efforts toward continual improvement and Lean Initiatives must result in improved product / process quality, delivery, and overall efficiency and effectiveness that will result in price reductions and the cost of doing business.

Avnet supply chain Code of Conduct

Avnet expects its suppliers to be responsible global citizens and adhere to laws and regulations not only within the US, but in all countries to which Avnet operates. In addition, to our minimum expectations, our suppliers are expected to adhere to the Responsible Business Alliance (RBA) Code of Conduct, for the fair treatment of workers, their health and safety in their work environment, for the protection of the environment, and for excellent business ethics e.g., complying with management systems for: Social Responsibility like ISO 19600, Anti-Bribery/Anti-Corruption programs as of ISO 37001 and Compliance Management Systems following e.g., ISO 19600. Please also refer to [GLOBAL HUMAN RIGHTS POLICY](#) for further details.

Avnet Supply Chain Due Diligence

Avnet is committed to complying with the requirements of applicable Supply Chain Due Diligence (SCDD) standards, including respecting human rights and environmental concerns within our own business activities as well as in our global supply and value chains. In this context, we expect our suppliers to collaborate with Avnet in its risk assessment process that has been put in place to comply with its supply chain due diligence obligations.

Avnet corporate citizenship

At Avnet, our commitment is to be responsible corporate citizens in our global communities and to our four critically important stakeholders: employees, customers, suppliers, and shareholders. That commitment is ever-expanding in the way we conduct day-to-day business.

Avnet encourages our employees to volunteer in their communities, and we demonstrate that commitment with paid days off to our employees who volunteer to help make a difference. We encourage our suppliers to demonstrate similar commitments to the communities they live and serve.

We have a strong commitment and demonstrate actions that have reduced Avnet's environmental footprint in our facilities by means of power generation and conservation, recycling, and smart supply chain practices.

Avnet works with our suppliers committed to being responsible corporate citizens through ongoing environmental health and safety programs. It is preferred that suppliers to Avnet demonstrate this commitment within their well-established management systems or establish them as independent systems:

- Environmental Management following ISO 14001 registration at a minimum.
- Adherence to Occupational Health and Safety Management System (OHSAS) ISO 45001.
- Information Security Systems / Cyber Security Management implemented in adherence to ISO/IEC 27000, ISA/IEC 62443 family or ISO/IEC 20000 family.
- A reasonable Risk Management considering but not limited to the requirements of e. g. ISO 31000 or ISO 14971.

Suspected Unapproved Parts (SUP) incl. counterfeit mitigation

A strategic advantage in doing business with Avnet is our Suspected Unapproved Parts including counterfeit mitigation processes are an intricate integral part of our everyday business. By having detailed distribution agreements with our supplier partners, there is an unbroken chain of custody with the Original Component Manufacturers and OEM's that ensures products delivered to Avnet and to our customers, are authentic, approved and eliminate the concern of counterfeit parts.

This means two options for what we require from our Suppliers:

- Minimum adherence to counterfeit/fraudulent mitigation standards as a part of their policies and mgmt. system.
- Preferably being certified to AS 6081, AS 5553, JESD 243 or AS 6496 or equivalent standards.

Non-disclosure agreements

Suppliers and/or Subcontractors to Avnet may be asked to enter into a non-disclosure agreement or a confidentiality section in the Buy Sell or Master Distribution Agreement, with Avnet concerning information provided to our supply chain such as drawings, specifications, procedures, forecasts, pricing and Avnet terms and conditions. This information shall be considered intellectual property, proprietary and confidential to Avnet and our customers. Suppliers and/or Subcontractors shall not use and/or transmit this information to 3rd parties outside the terms of this agreement.

Contractual flow down / terms and conditions

As a Franchise-Agreement Partner, Non-Franchise Vendor or Subcontractor providing value add services to Avnet, it is your responsibility to ensure a clear understanding of standard contractual flow downs originating from our customers and Avnet Terms and Conditions prior to acceptance of the purchase order. A link to Flow Down requirements is on every Avnet Purchase Order, and can be found here:

[Avnet US Terms and Conditions of Purchase](#)

[Avnet EMEA Terms and Conditions of Purchase](#)

General expectations – Avnet’s customer requirements

Avnet’s customers, ranging from individuals to large multinational corporations, have chosen Avnet as a supplier because of the value and quality of its people, the relationships we have with our suppliers, the speed and flexibility of our service and the reliability of the products we supply. This level of customer commitment requires that Avnet only work with those suppliers that demonstrate the same commitment to Avnet.

Customer requirements

The customer is defined as Avnet’s external customer, to whom Avnet delivers products and services. Avnet’s customer requirements vary and are subject to change based on market conditions, competitive pressure, government regulations, technological change, and organizational needs, strategies, and goals.

Key Metrics important to both Avnet and its customers.

- Product Quality
- Appropriate packaging
- Full identification and traceability on all packaging levels-
- On Time Delivery
- Accurate Shipment/Invoicing
- Inventory Availability
- Business Contingency plan
- Professional Service and Support
- Competitive Pricing
- Counterfeit Mitigation
- Environmental Compliance

Avnet also promotes and encourages the use of “Lean tools” and strategies in our supply chain as a means of achieving best overall value to Avnet and its customers.

DPAS rated purchase orders

When an Avnet Purchase order contains a DPAS or similar rating, such as DO-A3, DX-A1, please refer to the Defense Priorities and Allocations System (DPAS) regulation, 15 C.F.R. Part 700, found in the appendix section.

Because these are military rated orders where regulations apply to both military and commercial product, it is imperative for all our Suppliers to fully understand and comply with the requirements of the DPAS regulation. The same shall apply for e.g., EU or any other equivalent national laws or directives in force.

Avnet identification/labels

To maintain Avnet identification and traceability information, Avnet labels and/or bar codes must be maintained and transferred to any new packaging. This chain of custody must be maintained to ensure there is no cross contamination with non-Avnet product potentially leading to concerns of counterfeit parts.

Our goal, operational excellence

As a global leader, Avnet not only faces the daily challenges supporting our customers an ever changing and competitive global manufacturing landscape, but also continually improving the way we conduct business in order to maintain a competitive advantage to better serve our customers. By providing our customers with a dynamic, strategically accessible, world class supply chain to our customers, we see our supply chain as a key component of that competitive advantage.

Avnet’s continuous improvement mindset is central to everything we do, including our relationships with our supply chain. Our supply chain strategy has evolved over the years from one of just managing transaction to forming stronger business relationships with an emphasis on communication, shared goals, and collaboration.

With collaboration, we encourage our supply chain; both suppliers and Subcontractors, in partnership with us, to jointly identify, develop, and implement ideas that improve, strengthen, and advance our supply chain relationships. Together we'll use our best thinking and practices to foster change, improve performance and grow our collective businesses. Whether it is providing better technology, using innovative design concepts, improving your manufacturing processes, or applying "Lean" strategies to better your business, everybody benefits when suppliers share their best practices.

Supplier communication

It is critical to the overall success of both our organizations that our supply chain fully understands the requirements and expectations of Avnet by means of this handbook, contractual flow downs, purchase order requirements, quality clauses, supply chain qualification questionnaires, supplier scorecards and/or business reviews and a continuous and open exchange of information required for driving the business.

Currently, Avnet is taking its supply chain quality organization to the next level by establishing and defining key processes that will help us standardize how we conduct business, enabling supplier communication, partnerships, and overall operational excellence.

Classifying our supply chain

Avnet has classified our supply chain into three categories: Franchise partner suppliers, non-Franchise suppliers or otherwise known as Complementary Sales Partners (CSP), and Subcontractors.

Franchise Partners: Franchise Partners are OEM manufacturers of electronic parts with whom Avnet has entered into established distribution agreements. Avnet Franchise Partners are represented by the "line card," demonstrating that the OEM suppliers have been partnered with in accordance with established policies and procedures.

Non-Franchise Supplier: Non-Franchise suppliers are OEMs or other sources within distribution with whom Avnet does not have an established distribution agreement like Complementary Sales Partners (CSP) or partners where either a Complementary Sales Partner Agreement or a Buy-Sell Agreement is signed. Non-Franchise suppliers are often customer-specified sources where customers have already qualified the design and the associated parts, and we simply act as the distributor of customer-specified products.

Subcontractors: value add services:

To better serve our customer needs, Avnet has established relationships with special process / value add services Subcontractors for additional value add processing prior to customer delivery. Subcontractor Value Add services range from testing, screening, environmental testing, lead forming, and tape and reel. Subcontractors are customer identified and/or customer requested by means of source control drawings, specification control, flow down requirements, and/or are already approved and qualified via the customer's Subcontractor management program.

Supply chain approval status

Avnet Supply Chain Quality has established approval levels of its supply chain to identify current approval status and to identify procurement options as to which supply chain source is approved.

In the case of Franchise Partners to which Avnet has established a distribution agreement with, upon completion of the on-boarding process and assessing the risk evaluation, franchise partners will appear on the Avnet Line Card describing products available for purchase.

Non-Franchise Vendors supplying parts to Avnet to which there is no distribution agreement, may not be monitored nor measured as these are customer specified distribution vendors outside the controls of Avnet.

Value Add Subcontractors is where most of the controls and support processes will be applied. While these subcontractors will be monitored and measured in accordance with established Avnet performance expectations

Definitions: Primarily associated with Value-Add Subcontractors, the following definitions apply to identification of current approval status.

Approved: The subcontractor has demonstrated a level of minimal conformance to Avnet requirements (set forth within this Global Supplier Quality Handbook) upon initial assessment and qualification and/or has demonstrated ongoing approval based on established performance metrics on a periodical basis or replying satisfactorily and to all conscience on the Avnet EMEA's Supplier Assessment Questionnaires addressed to them.

Conditional Approval: The subcontractor has not performed to the minimum performance expectations set by Avnet. Once established as an approved Subcontractor, if the performance level drops below the performance level expected by Avnet for one quarter, the subcontractor will be placed on "conditional approval" status. The subcontractor will be issued a request for corrective action or process improvement plan and will be expected to recover and improve overall performance by the following quarter to be taken off conditional status. Appropriate replying to Avnet EMEA's Supplier Assessment Questionnaires (focusing on but not limited to quality & environmental compliance) acts as an enabler to future business.

Restricted: A subcontractor is placed in "restricted" status because of deficiencies from two different paths. If a subcontractor fails to meet the requirements and expectations of Avnet upon initial assessment/qualification, the subcontractor will be identified as "restricted" for use only by the customer that specified the Subcontractor.

The other path is because of a Subcontractor failing to recover from "conditional" status for the 2nd consecutive month and status will be changed to "restricted" for use only by the customer that specified the Subcontractor originally.

Supply chain performance

Avnet has established comprehensive supply chain management program to effectively identify, qualify, monitor, manage and communicate to its supply chain. Subcontractor performance scorecards and Supplier performance data processes have been created to effectively communicate their current quality performance and approval status to the supply chain.

Each method of communication will be detailed within each classification section herein.

Supplier On-Time Delivery (OTD)

A key element of the ability of Avnet to service our customers is the availability of products against our required delivery dates. Within Avnet we have established a definition of OTD. We expect products to be delivered to our distribution centers within a window of seven (7) days early to three (3) days late when measured against the 'First Confirmed date' given by the supplier. These will be classed as meeting our OTD expectation with deliveries outside this window classed as either early or late accordingly.

Performance reviews

Suppliers are encouraged to participate in performance reviews, the frequency of which will be mutually agreed upon. In addition to Performance to sales and Supplier quality goals, these reviews will assess conformance to mutually agreed upon requirements. Upon special request, mostly from automotive or avionic/space industry Supplier shall be prepared to share component (or at least product families') ppm rates or yields with Avnet and its Customers.

Process improvement program

When a supplier and/or Subcontractors performance falls below the minimum requirements as set by Avnet, a request for corrective action will be requested from Avnet Supply Chain Quality in an effort to identify the root cause(s) for the deficiencies and to implement corrective actions to improve as reflected in quarterly score cards and/or severe isolated performance issues. Score Cards shall be issued quarterly. Subcontractors and/or suppliers falling below the minimum performance requirements for quarter will be notified of the declining performance by means of a Supplier Corrective Action Request (SCAR).

Supplier Corrective Action Requests (SCAR) / Technical Failure Analysis Request (FAR)

Upon identification and validation of non-conforming parts, material and/or services by Avnet as non-conforming to stated requirements, a request for corrective action with detailed information will be forwarded to the supplier and/or Subcontractor to assess the identified non-conformance and determine the root cause and appropriate corrective action that is required to correct the issue.

Avnet requires that the suppliers and/or Subcontractor go into adequate depth in the root cause investigation to ensure this non-conformance or any similar non-conformances from occurring in the future. Please include enough detail in the corrective action response for not just a containment statement or a root cause description but also what actions were taken to prevent re-occurrence, what processes were modified to address the issue, and who was trained on the process/procedure changes. The SCAR form that Avnet will send will identify what objective evidence is required to support the action taken, such as a list of procedures/processes modified w/document numbers and revisions and electronic copies of the training records as our customer require this objective evidence when Avnet is evaluated.

Supplier to Avnet shall cope with the stipulations in JESD 671 (latest rev.), especially:

- Have a Component Quality Problem Analysis and Corrective Action Process in place, including Administrative Quality.
- Support both a "Standard" and an "Urgent" path (indicated by Avnet EMEA or field of component application, e.g., automotive).
- Supplier's analysis duration shall not exceed the JESD 671's given times (= from sample receipt till completion of failure analysis, including communication of results back to supply chain)
- JESD 671's T's & C's like for "days", "event", "analysis facility receipt of samples" shall apply.

SCAR responses are required within 15 business days of receipt.

The SCAR will identify the specific areas for improvement required to improve the Subcontractors / supplier's overall performance, as reflected by the scorecard, and a defined time for objective evidence of improvement. Suppliers are expected to develop a comprehensive program for improvement that represents sustainability if they receive a process improvement-oriented SCAR. Once the performance improvement has been reflected in the next quarter's scorecard, the improvement will be noted in the SCAR as part of the objective evidence.

Supplier Improvement Request (SIR)

In certain circumstances a request for improvement (SIR) will be forwarded to the supplier and/or Subcontractor to assist Avnet in improving internal processes. These would usually relate to physical product receipts or handling at our distribution centers and are designed for both the supplier and Avnet to work together and find an agreeable solution to the issue. The SIR is a standard form with areas for suggested actions to be taken and supplier feedback or comments. Avnet requires that an SIR is completed and returned to the issuing office within 60 days.

In-Process Failures (IPF)

Subcontractors shall communicate all in-process failures of Avnet supplied product, within forty-eight (48) hours of the recorded failure and within twenty-four (24) hours, for automotive industry customers. Post notification receipt, Avnet will instruct Subcontractor how to process failed product. Failure notification will include the following information as a minimum:

- Manufacturer
- Manufacturer Part number (MPN)
- Quantity
- Purchase Order received against
- Shipping papers/delivery note(s)
- Identification of the components affected, (Date/Lot/trace code, serial number (if applicable))
- Description of failure

If Avnet requests product be returned, Avnet will provide an RMA (Returns Material Authorization) as to where to ship the product and what information is to be referenced on the paperwork and shipping label.

If Avnet authorizes the Subcontractor to destroy the Product, the Subcontractor shall issue to contractor a certificate of destruction that complies with all government rules and regulations and that lists each serial number from each destroyed component.

Subcontracting

Avnet subcontractors conducting value add process and/or special processes shall not subcontract out any processes unless expressly waived by Avnet in writing upfront. However, such a subcontracting approval shall not be considered relieving Avnet's suppliers from their lawful or contractual duties.

Hold harmless agreement

When a subcontractor fails to meet the minimum performance requirements identified for two (2) consecutive months, the customer that specified the subcontractor will be required to sign a "hold harmless" agreement stating that since the Subcontractor has failed to meet the performance expectations of Avnet, the customer holds Avnet harmless to any actions as a result of continuing to use the subcontractor.

The "hold harmless" agreement would also apply during initial assessment / qualification whereas the Subcontractor does not meet the initial baseline requirements to be "approved".

The intent would be to encourage all Avnet Subcontractors to gain and maintain "approved" status whereas that subcontractor may be used for services required for all Avnet customers.

Business interruption plan

Avnet Suppliers shall maintain an effective business interruption/disaster recovery plan throughout the term of the relationship. Supplier shall notify immediately employing the PCN process including the Avnet emails of "at risk" products/components/services or any other circumstances putting the subsequent supply chain at risk. This plan is especially important for single-sourced product/components. "At risk" is defined as products or components that are single or sole-sourced at Supplier or are at risk in the Suppliers' supply chain.

Corrective action

Avnet may reject incoming material that does not conform to the specifications outlined in this document and may issue a Supplier Corrective Action Request (SCAR). See Supplier Corrective Action section above.

Military-rated orders

Suppliers will handle military related orders according to the Defense Priorities and Allocations System (DPAS) regulation, 15 C.F.R. Part 700. Because these military rated orders regulations apply to both military and commercial product, it is imperative for all our Suppliers to fully understand and comply with the requirements of the DPAS regulation.

Engineering Change Notification (ECN), Product Change Notice (PCN), End-of-Life (EOL), Product Discontinuance Notice (PDN), Product Termination Notice (PTN)

Providing our organization with critical component changes that may affect our customers' product design, production and procurement is an important piece to providing comprehensive Customer support.

The PCN/ECN (= Engineering Change Notification) and PDN/EOL process begins with our Suppliers. Supplier assures to comply with the minimum following the stipulations in J-STD-046 (for PCN's) and J-STD-048 (for PDN's/PTN's/EOL's) in their latest revision and at least for 24 months after latest delivery for all products.

For especially qualified components like automotive (e. g. AEC-Qxxx) Supplier compliance with "ZVEI Guideline for Customer Notifications / PCN (latest rev.)" is clearly preferred.

All product change notifications (PCN) and product discontinuance notifications (PDN) shall be sent to the following e-mail addresses, however always depending **on the contracting authority**:

All Change Notifications (ECN's, EOL's, PCN's, PDN's & PTN's) should be sent to:

Avnet Inc.:

- End-of-Life@Avnet.com

Avnet EMEA:

- EBV: PCN@EBV.com
- Avnet Silica, Avnet Embedded: EMEA-EOL-ADMIN@Avnet.eu
- Avnet Abacus: PCN-Abacus@Avnet.eu

Change notification data requirements

All notifications shall be provided in an Excel format and are required to include the following information as applicable:

- Avnet complete part number (CPN) and/or Supplier/Manufacturer Part Number (MPN if different)
- End buy date
- End return date
- End ship date
- Order non-cancelable date
- Original notification date and revision date
- Last date the factory will accept returns
- Manufacturer replacement part, if available
- This data can also be incorporated into the Supplier's price file feed
- New P/N and/or revision level
- Description of change
- Reason for change
- Date of change
- ECN/EOL/PCN/PDN/PTN reference
- Effect of change

Avnet will attempt to process all change notifications provided in other formats, but delays may occur if information is missing from the list above.

Product alerts and recalls

All Supplier product alerts, recalls or similar notifications if any shall follow the PCN approach to the extent applicable and shall be sent without any delay to the following e-mail addresses.

Avnet EMEA: product-recall-alert@avnet.eu

Avnet Inc.: End-of-Life@Avnet.com During a product recall, an alert or similar notification the Supplier shall also

- Clearly specify all the affected products, Date Codes or LOTs, even merely on suspicion
- Define and communicate the further strategy of
 - Notifying the subsequent supply chain towards market
 - Dealing with and disposing such material

Note: Lack of notifying each and every single affected contracting authority within Avnet individually is absolutely unacceptable.

Finished product shipments

Subcontractors shall ship all products to the Ship-To company and address, via the appropriate carrier, as specified on the Purchase order. Any freight charges incurred because of shipments tendered contrary to our instructions will be debited back to the subcontractor.

For us to complete our invoicing to the Customer, on the day a shipment is made the following shipment information is required at a minimum is to be sent to Avnet via email or fax:

- Copy of invoice
- Purchase order number
- Carrier
- Tracking or waybill number
- Number of pallets or containers
- Copy of CoC if one is required
- In the case of partial shipments, the Subcontractor will notify the applicable material representative. Partial shipments require authorization from an Avnet materials representative
- Additional Consideration for Military/High Reliability Product

Avnet purchase order requirements will not supersede military specifications or government regulatory agencies requirements.

Suppliers' shipments of military product or Established Reliability (E/R) product will include Certificate of Conformance (C of C) documentation and the Supplier will maintain traceability documentation. Any military specification governing content of Certificate of Conformance requirements always takes precedence.

Suppliers must include all required documentation (Certificate of Conformance, data, reports, etc.) as specified by military specification and/or Avnet purchase order in the shipments of military devices. Avnet should not receive more product than is listed on your Certificate of Conformance.

All product received will comply with the appropriate governing military specification and/or the Avnet purchase order. Supplier C of C's (Certificate of Conformance) must be legible and include the following information:

- Supplier name and address
- Avnet Customer's name and address
- Avnet Customer's part number
- Avnet Customer's purchase order number
- Quantity
- Date/lot code
- Statement of certification to the applicable manufacturer, military, government, and/or industry specification
- Signature of duly authorized Supplier personnel

Audits

Avnet requests a minimum of thirty (30) days' notice prior to performing an audit of our operations. All such audits shall at minimum follow but not necessarily be limited to the vital ISO 19011 guidelines for auditing management systems. Upon special request from Avnet its Suppliers shall allow 2nd party assessments held by contracting Avnet companies, our customers and/or representatives of regulatory authorities upon prior notification and agreement of the scope.

Product quality

All products delivered by suppliers shall conform to published specifications, data sheets and drawings. Any custom or non-standard products shall be subject to individual agreements.

Products shall always be packaged with due diligence and appropriately following the applicable industrial standards for ESDS & MSD (electrostatic discharge sensitive or moisture sensitive devices). Only full packs (tubes, reels, trays, and boxes) shall be shipped. Each MPQ (minimum pack quantity) shall contain exclusively one single production date code or one batch/lot.

At the time of receipt of moisture sensitive devices (MSD) by Avnet EMEA their remaining shelf lifetime in Supplier's moisture barrier bag (MBB) shall be greater than min. 50% of the calculated total shelf lifetime since initial bag seal date.

All Suppliers shall be clearly committed to a zero-failure-policy and will continuously strive to optimize their services and mitigate potential risks throughout the entire supply chain. Upon special request, mostly from automotive or avionic/space industry Supplier shall be prepared to share components' or alternatively at least product families' ppm-rates or yields with Avnet and its Customers.

The Supplier shall keep records of the above-mentioned quality assurance procedures, especially those relating to measured values and test results. The Supplier shall retain these records as well as representative product samples and their data sheets in an appropriate manner for a minimum of 15 years after last product shipment.

Product delivered shall not exceed a production date code limit of max. 24 calendar months unless upfront notified to but also waived by Avnet. Products subjected to extended shelf lifetime (ESL) or similar programs may deviate from that only if their warranty is at least considerably extended in the direction of their extended shelf life ending.

All components and material shipped to Avnet shall conform to all environmental compliance requirements like laws, directives and any other applicable regulations or restrictions (see also chapter "Environmental Requirements").

The components identified on shipping papers, packaging level, and its label must always and free of doubt represent the material contained.

A clear and 100% error-free identification system for the components, including their individual qualification or intended field of application like:

- standard (commodity/commercial) products vs.
- especially qualified ones (AEC-Qxxx, space flight, medical, security, extended temperature, radiation-proof) vs.
- non-qualified ones like prototypes, samples, engineering models...

must be secured throughout all packing levels, including any accompanying papers is imperative.

Upon request, the Supplier shall provide clear description of how to identify production information:

- Production date code
- Production lot
- Production site
- Country of origin
- Optionally: Unique trace code, serial number, etc.

Product and packing material compliance

Avnet is committed to protecting the natural environment in the communities where it does business.

Avnet will proactively promote the preservation and renewal of resources and will consistently practice socio-ecological responsibility in all of its corporate operations with a focus on continuous improvement in the interests of current and future generations.

Avnet's desire to identify lead-free / RoHS conforming components is in response to legislative mandates to ban lead from electronic products and to meet the growing needs of our valued Customers to supply environmentally friendly products. As a result, we have identified how we would like you to handle this and what kind of communication needs to occur. Suppliers will:

- Notify Avnet, by part number and EU-RoHS Level.
- Notify Avnet, by part number, if EU-REACH SVHC contained
- Create two (2) unique part numbers if providing parts which are both non-lead-free and that meet the lead-free requirements.
- Provide Avnet with part number attribute data, including but not limited to HAZMAT content by percent.

AVNET'S LEAD-FREE/ROHS DISCLAIMER

“ANY CERTIFICATION, REPRESENTATION, WARRANTY OR DETERMINATION THAT PRODUCTS SOLD BY AVNET ARE IN COMPLIANCE WITH THE ROHS OR WEEE DIRECTIVES OF THE EUROPEAN UNION OR OTHER REGULATORY REQUIREMENTS MUST BE OBTAINED FROM THE MANUFACTURERS OF THOSE PRODUCTS. AVNET IS MAKING EFFORTS TO OBTAIN THAT INFORMATION FROM ITS SUPPLIERS BUT AVNET MAKES NO CERTIFICATION, REPRESENTATION OR WARRANTY THAT THE PRODUCTS SOLD BY AVNET ARE LEAD-FREE, “GREEN”, OR OTHERWISE IN COMPLIANCE WITH THE ROHS, REACH OR WEEE DIRECTIVES OF THE EUROPEAN UNION OR OTHER REGULATORY REQUIREMENTS.”

Please contact Avnet Quality Assurance, or Environmental Department, with questions about the above RoHS and REACH compliance requirements.

Environmental requirements

Avnet Logistics' initiative to identify RoHS and REACH compliant/conforming or non-compliant components is in response to possible legislative mandates to ban prohibited substances from electronic products and to meet the growing needs of our valued Customers to supply environmentally friendly products.

As a result, Avnet Logistics has identified how its Suppliers should handle this transition and what kind of communication needs to occur when doing so.

- Suppliers are required to notify Avnet when the product environmental compliance status is changed.
- Suppliers are recommended to change the Part Number when the product environmental compliance status is changed.
- Suppliers must identify outer containers with a RoHS conformance Indicator (Symbol Ref. J-STD-609 or “RoHS conforming” verbiage, Intermediate containers will also be identified with a RoHS conformance Indicator (Symbol Ref. J-STD-609 or “RoHS conforming” verbiage or IAC 1066)).
- Suppliers are required to provide Avnet with Part Number attribute data, including but not limited to HAZMAT and EU-REACHSVHC content by percent by weight (%).
- Suppliers are required to separate RoHS conforming products from non-RoHS conforming products.

Appendix I Avnet US / Avnet Asia

Compliance of products

In this section “Applicable Laws” means all applicable laws, directives, standards, codes, regulations and safety approvals; “Relevant Requirements” means all the standards with which the Products and packaging must comply in order to meet relevant health and safety, performance or electronic or electromagnetic interference requirements in any jurisdiction in which they will be sold including, without limitation RoHS Directive 2011/65/EU, REACH Regulation (EC) 1907/2006, Toxic Substances Control Act (TSCA), FCC regulations, California Proposition 65, Maine LD 1503 (HP 1113) PFAS regulations, Minnesota HF 2310 (Chapter 60) PFAS regulations, FDA regulations; and “Technical File” means the file of technical information regarding any Product, its design, composition and performance characteristics (including, without limitation, reports of tests carried out on the Product) that confirm the conformity of that Product with the Relevant Requirements and that contains all of the information specified by the Relevant Requirements or any guidance produced by the bodies with responsibility for enforcement of the Relevant Requirements.

The Supplier warrants that all Products sold to Avnet and Product packaging, (a) are in full compliance with all Applicable Laws, (b) meet the Relevant Requirements, and (c) are duly marked and labeled and are suitable for resale or other distribution by Avnet. The Supplier will inform Avnet of any change to the certification and/or approval status of such Products or packaging.

Standard C of C requirements

Supplier C of C's (Certificate of Conformance) will be legible and include the following information:

- Your name and address
- Avnet's name and address
- Avnet's part number
- Avnet's purchase order number
- Quantity
- Date/lot code
- Optional: Other important product specific data (MSL/PBT, luminosity, Serial No. etc.)
- Statement of certification to the applicable manufacturer, military, government, and/or industry specification
- Signature of duly authorized Supplier personnel

Label requirements

Avnet Suppliers will develop shipping container labels similar to code 128, PDF 417 or ECC-200 bar code technology. All bar coded and human readable information must be on the outer container or packing slip. Dock-to-stock packages are not opened for inspection. Packing Slips must be attached to each order.

Each shipment and where applicable each smallest packing unit (MPQ) should be marked with barcode labels as specified in this Annex.

All data should be provided in human readable text and bar-coded (code type 39 or 128).

This Annex outlines labeling requirements for 1D bar-coded information and is required on all inbound products received by Avnet Logistic Service Center locations.

The Annex contains detailed information that defines Avnet LSC (Logistics Service Center) shipment and labeling requirements, but not limited to, for:

- Order and Packing Slip content
- Shipping Method & Product Packaging definitions for:
 - Shipping carton labels

- Intermediate packaging labels
- Product packaging labels
- RoHS Identification
- REACH SVHC identification
- Human readable and bar-coded data requirements
- Bar Code label and data content requirements for:
 - Consolidated shipments
 - Individual box shipments
 - Product packaging and bar code information

Avnet logistics 1D labeling requirements for inbound products

The following criteria must be followed for all inbound orders to all Avnet LSC locations:

- Only one purchase order line item may be shipped per packing slip.
- Each line item must have its own packing slip.
- For each line item in a purchase order where multiple boxes of the same part number are shipped, the packing slip will be affixed to Box #1 of xx.
- All boxes in a single line item must be consolidated (grouped) together in the same external carton or on the same pallet.
- Only one lot code and/or date code will be shipped per packing slip.
- Country of Origin must be present and bar-coded on internal labeling, packing slip as well as on all product packaging.
- System generated RoHS or Pb-Free product status must be identified using JESD 97. All elements bar coded in Label 1 must be bar coded in code 39 or 128 and human readable. Code 128 is preferred.
- “RoHS Comp” or “RoHS Compliant” terminology is acceptable should it apply directly. Product that is RoHS compliant under exemption should be identified as “RoHS Comp. by Exemption” followed by number of exemptions.
- “REACH SVHC contained” followed by name of contained SVHC in human readable format.
- All Date format requirements, excluding Manufacturer Date Code will be defined by the regional Avnet LSC (YYYY-MM-DD or MM-DD-YYYY are preferred).

Shipping label requirements for product packaging

Product Packaging & Shipping Method Definitions:

External Packaging:

Outer shipping boxes used for carrier transporting of product from the supplier to Avnet. Multiple orders shipped to Avnet that are not normally consolidated in larger shipping containers.

Internal Packaging:

Packages usually inside the shipping box containing single or multi-box orders which are consolidated for shipping.

Individual Box Shipments:

These orders are separate line-item orders shipped separately on the carrier and not consolidated. The packing slip must be affixed to each order or box #1 of multi-box orders. All multi-box orders must be placed together on a shipping pallet. Orders shipped in this manner are in external packaging and must be labeled per Label 1.

Consolidated Orders:

These orders are separate line-item orders that are placed in a larger (external) container for shipping purposes. The larger external container must be labeled per Label 2.

When consolidating orders, packing slips must be affixed to each single internal box order or box # 1 on multiple box orders. Individual boxes packed in consolidated shipments should be labeled per Label 1. Label layout is flexible.

Product Packaging:

A single unit defined by the supplier that provides means of protection for transportation, storage and identification. Typical examples are: Single reels, rails, trays or bulk packaged components. This product should be labeled per Label 3. Tape & Reel product must be labeled on the reel and the individual reel box.

SUPPLIER NAME		AVNET LSC 60 SOUTH MCKEMY CHANDLER, AZ USA 85226	
(K)PURCHASE ORDER NUMBER		H0504309722	
(3S)PACKLIST NUMBER		OPJ002F	
(P)PART NUMBER		12345654321-1	
(1P) MANF. PART NUMBER		XLX25986-FPG144H	
(Q) QUANTITY	55000	(4L)C00	CN
(1T)LOT NUMBER	123456254	(9D)D/C	0515
MSL: XX		TEMP: 260C	REV: XXX
SEAL DATE: YYYY-MM-DD			
RoHS Compliant			
BOX COUNT		PACKAGE WEIGHT	
17 OF 19		11.4 KG 25.0 LB	

LABEL 1

Inbound shipping label requirements for external packaging

LABEL 1

Human Readable & Bar Code 128 format is required for:

- (K) Purchase Order
- (3S) Pack List Number
- (P) Customer Part Number
- (1P) MFG Part Number
- (Q) Quantity
- (4L) Country of Origin
- (1T) Lot Code (where applicable)
- (9D) or (D) Date Code (YYWW)



Human readable information only:

- Ship From
- Ship to
- MSL
- Peak Body Temperature
- Rev. (Part Revision)
- Seal Date
- RoHS Status Level or Pb Free ID
- CE Mark (if applicable)
- REACH SVHC contained (if contained)
- Package Weight (LBS. & Metric Required)
- Box Count







Explanation: (LABEL 1)

- (K) Purchase Order: Avnet Purchase Order Number must be bar-coded as shown without spaces or hyphen.
- (3S) Packing List Number: Unique Identification number assigned by the supplier that allows traceability for receipt discrepancies related to purchase orders and inbound quality issues (3S, 4S, 11K are acceptable options).
- (1P) MFG. Part Number: Required and must be bar coded and match part number ordered exactly for scanning purposes if Avnet part number is not available.
- (Q) Quantity: All quantity labels must only reflect actual box quantity. Total line item/packing slip quantity can be noted on Label 1 but must be identified as Pack Slip Quantity only!
- (4L) Country of Origin: 2 Character ISO format required. Reference document: ISO 3166 - (1T) Lot Code/Number: Only one lot code and date code per line item and part number.
- (9D) or (D) Date Code - YYWW Product creation date: Device manufacturing date required not product ship date. Supplier date codes not in the YYWW format must be converted and placed on the label in human readable and bar-coded form.
- MSL: Moisture Sensitive Level (according to JEDEC 033) where applicable.
- TEMP: Peak Body / reflow temperature.
- REV: Device Assembly revision or Grouping, where applicable.
- Seal Date: Moisture Barrier Bag Seal Date (YYYYMMDD or MMDDYYYY, region specific format defined locally).

LABEL 2

Ship From Address BURLINGTON AIR EXP waybill: 5550007912 	Ship To Address
(3S) PKG ID: 0033317 + 7388081 	
MIXED LOAD	
(Q) QUANTITY: 	122
(Z) OPTIONAL	
DESC: 2.5V SA, SVIN ISR, VERT	
PACKAGE COUNT 1 OF 1	PACKAGE WT. 16.00 LBS 7.25 KGS
SWB: 0024249616 BX#: 7388081	

LABEL 3

SUPPLIER NAME		
(P)PART P/N: 12345654321-1 		
(1P)MFR P/N: 12345654321-1 		
(Q)QTY: 5500 	(4L)COO: CN 	MPQ: XXX
(9D)D/C: 0515 		(1T)LOT CODE: 1234567890 
MSL: XX	TEMP: XXXX	REV: XXX
Seal Date: YYYY-MM-DD		
RoHS Compliant		

SUPPLIER NAME		
(P)PART P/N: 12345654321-1 		
(1P)MFR P/N: 12345654321-1 		
(Q)QTY: 5500 	(4L)COO: CN 	MPQ: XXX
(9D)D/C: 0515 	(1T)LOT CODE: 1234567890 	
MSL: XX	TEMP: XXXX	REV: XXX
Seal Date: YYYY-MM-DD		
RoHS Compliant		

LABEL 3
(smaller version, typically on the part package within the outer container)

LABEL 4

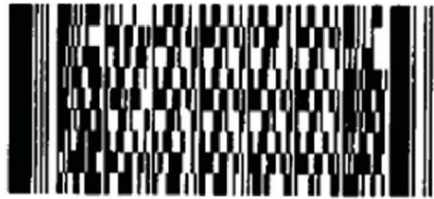

LABEL 3

All product labels that affix directly to product packaging i. e. rail bags, dry pack packaging, reels and reel boxes etc. must have the following elements bar coded and in human readable form.

Human Readable & Bar Code 128 format is required for:

- (P) Customer/Avnet Part Number
- (1P) Supplier Part Number
- (Q) Quantity
- (4L) Country of Origin
- (9D) Date Code (YYWW)
- (1T) Lot Code (where applicable)

Human readable information only:

- Supplier name
- MPQ
- MSL – TEMP (peak body / reflow temperature) - Rev. (Part Revision)
- Bag Seal Date
- RoHS Level or Pb Free ID
- CE Mark (if applicable)
- REACH SVHC contained (if contained)

Explanation: (Label 3)

- (P); (1P): Customer/Avnet and Supplier Part Number are required. When Avnet p/n is not available, supplier p/n is required. The bar-coded part number must match part number ordered by Avnet exactly.
- (Q) Quantity: Quantity in single bag or reel.
- MPQ: Minimum Package Quantity - Quantity of product in a single reel, tray or rail for each part number.
- (9D) or (D) Date Code: Format YYWW required.
- (1T) Lot Code: where applicable.
- (4L) COO: Country of Origin in ISO3166 two Character standard.

- MSL: Moisture-Sensitive Level when required.
- TEMP: Peak Body or Solder Temperature
- REV: Device Assembly revision, Grouping or Stepping
- Seal Date: Moisture Barrier Bag seal date from the supplier.
- Format: MM/DD/YY or (ISO) YYYYMMDD (preferred). Regional Logistic Service Center to define date format required.
- RoHS or Lead-Free Identification Text or Symbol.
- Preferred Formats: RoHS Comp, RoHS Compliant, RoHS Comp by Exemption followed by number of exemption, Pb Free.

Pb

- EU-RoHS compliant as of xxxx/xx/EC
- CE Mark if product is conforming to CE requirements. Format: (at least 5mm by 5mm)
- REACH SVHC(s) information: “REACH SVHC(s) contained: (listing of the SVHC(s) name)

Approved 2D Labels (Label 4):

- The format for the 2D bar code includes requirements for 1D back up information in the event the 2D is damaged or not readable.
- The data structure used to create the 2D data string is based on the selected scanning hardware and current Avnet system guidelines.
- Different field separator characters and data identifiers are utilized for compatibility with the scanning hardware used by Avnet.
- PDF417 and Data Matrix ECC-200 are the accepted format options for 2D product labels.
- Data Matrix ECC-200 PDF417 Format

2D external labeling specifications

- (K) Purchase Order Number – H050XXXXXXXX This specific, fixed format must be used without the addition of spaces or dashes. “H050” identifies the Avnet destination location. Avnet Purchase Order must be 11 digits with 4 for H050 and 7-digit P.O. numbers.
- (11K) Packing List # - Unique identification number assigned by the Supplier that allows traceability for receipt discrepancies related to purchase orders and inbound quality issues. 3S, 4S, 11K are acceptable options.
- (M) Manufacturer code 0 This 3-character code identifies each Supplier within Avnet systems and is created by Avnet and is available upon request.
- (P) Part Number – Orderable part number that matches the packing list part number.
- (Q) Quantity– This must be the packing slip quantity for the total line item. The linear (1D) quantity must only reflect the quantity in the individual boxes. Total order quantity must be referenced on the packing slip or delivery note.
- Important Note: Supplier must be able to add Date Code and Lot Code to the 2D bar code upon request.

Overview about barcode / human readable features: document requirements

Identifier	FEATURE/ATTRIBUTE	Labeling	Intermediate & Unit Container	Packing Slip
	Slip Bill to Address			
(4L)	Country of Origin	H	H	
(9D) or (D)	Date Code	B/H	B/H	
	Established Reliability (E/R) identification – when applicable	H		
	RoHS Indicator – Symbol Ref. J-STD-609B or “RoHS conforming” verbiage	H	H	
	REACH SVHC information	H	H	
	CE Marking	H		
	Battery containment information	H		
	Lithium Battery	H		
	Moisture Sensitive Level – when applicable per J-STD-033	H	H	
	Package Count – e. g. 1 of 2, 2 of 2	H	H	H

(3S)	Packing Slip Number		B/H	B/H
	Part Number	B/H	B/H	B/H
	Product Date Code – Packages with multiple date codes on one line item must identify each date code or list the oldest date code immediately followed by an “M” designating multiple date codes inside.	B/H		
(1T)	Product Lot Code – Military receipts	B/H	B/H	B/H
(K)	Purchase Order Number	B/H	B/H	
(Q)	Quantity	B/H	B/H	B/H
(S)	Serial Number – When applicable	B/H	B/H	
	Ship from Address	H		H
	Ship to Address		H	
	Waybill Number		H	
	Weight (followed by UoM (unit of measurement))		H	H

ANNEX 2: Packaging Requirements

Introduction

- The constant improvement of business processes is a significant strategy of Avnet. This includes not only our products but also logistic methods for the material flow, the packaging, the transport, and the handling of the goods.
- The target of Avnet is to reduce material handling. To achieve this, all packaging and transport methods have to meet the established regulations.
- With this regulation, the suppliers will be informed about the packaging requirements of Avnet. The following regulations are necessary to ensure a rational and accurate material flow between the suppliers and Avnet Logistics.
 - Avnet reserves the right to charge the costs of proceedings to the suppliers in case of divergence to these regulations, exception allowed in case of divergences due to a bilateral agreement.
 - The delivery dates are indicated on the purchase order and must be considered. In case of non-compliance with these dates, the goods cannot be accepted on time because the necessary capacities cannot be supplied in the required extent.
- The possible consequences of this situation might be that the heavy goods vehicle could not be unloaded or only with delay.
- Please coordinate any divergences from that regulation with the affected business unit or contact the receiving logistics location directly.

Delivery documents – general

- Only one purchase order will be shipped per container with one packing slip
- The delivery documents (delivery note, packing list, etc.) are to be attached to the goods on the outside of the box or pallet and should be in a protective envelope marked “Packing Slip”
- Before unloading the freight, forwarder documents must be handed over to the receiving operator in the goods receiving area
- For deliveries on pallets the freight forwarder document must state the total weight of the pallet and the number of boxes on the pallet
- In case of multiple pallet delivery for the same product, each pallet should be marked with a number of the pallet and total pallet delivery (e. g. Pallet 1 of n pallets)
- When multiple containers of the same P.O. are shipped, the packing slip should be attached on Box 1. Copies of the packing slip should be placed inside of each of the additional containers.

Content

The delivery documents must contain the following information:

- Purchase Order number & Purchase Order line
- Article Numbers
- Article description
- Document number (delivery note number / order number)
- Quantities
- In addition, the delivery documents can contain internal supplier statements.

Appendix II Avnet EMEA

Compliance of products including items of 3rd parties and packing material

Avnet is committed to protecting the natural environment in the communities where it does business.

Avnet will proactively promote the preservation and renewal of resources and will consistently practice socio-ecological responsibility in all its corporate operations with a focus on continuous improvement in the interests of current and future generations.

With respect to the ordered Products, including the whole package & all enclosed items delivered together with the products, also of 3rd parties, Supplier warrants and agrees that it has complied with all applicable laws, regulations, codes, rules, or ordinances, including but not limited to all applicable marking/labelling, registration, information and information obligations, governing the manufacture, import, sales and use of the Products in the EU / UK / EMEA countries, including but not limited to all applicable laws in the EU / UK / EMEA countries and all national laws in the EU member states, in the UK and EMEA countries based on substance regulations, waste regulations, and all other applicable EU / UK / EMEA countries regulations and directives, including but not limited to

'Substance regulations', such as but not limited to:

- Regulation (EC) No 1907/2006 on the Registration, Evaluation, Authorization and Restriction of Chemicals (REACH)
- Regulation (EU) 2019/1021 on Persistent Organic Pollutants (POP)
- Regulation (EU) No 528/2012 on Biocidal Products
- Regulation (EC) No 1005/2009 on Ozone Depleting Substances
- Regulation (EU) No 517/2014 on Fluorinated Greenhouse Gases
- Regulation (EU) 2017/852 on Mercury
- Regulation (EU) No 649/2012 concerning the Export and Import of Hazardous Chemicals
- Any other applicable legislations regulating substances, e.g., in UK or in any other country in the EMEA Region.

'CE /UKCA / product safety and compliance directives & regulations', such as:

- Directive 2011/65/EU on the Restriction of Hazardous Substances (RoHS)
- Directive 2014/30/EU on Electromagnetic Compatibility (EMC)
- Directive 2014/35/EU on Low Voltage Equipment (LVD)
- Directive 2014/53/EU on Radio Equipment (RED)
- Directive 2009/125/EC concerning Eco-design requirements for energy-related Products (ErP)
- Directive 2017/1369/EU on Energy Labelling
- Machinery Directive 2006/42/EC
- Directive 2014/68/EU on Pressure Equipment
- Regulation (EU) No 305/2011 on Construction Products
- ATEX Directive 2014/34/EU
- Directive 2001/95/EC on General Product Safety (GPSD)
- Regulation (EU) 2019/1020 on Market Surveillance and Compliance of Products
- Any other applicable legislations regulating CE, UKCA and other markings, as well as product safety and compliance.

'Waste directives', such as:

- Directive 2008/98/EC on Waste
- Directive 2012/19/EU on Waste Electrical and Electronic Equipment (WEEE)

- Directive 94/62/EC on Packaging and Packaging Waste
- Directive 2006/66/EC on Batteries and Accumulators
- Any other applicable legislations regulating waste, e.g., in UK or in any other country in the EMEA region as amended, modified, consolidated, re-enacted or replaced, including all related implementing and delegated acts and all related national implementing measures in force from time to time. Supplier shall bear all costs for the compliance of the foregoing regulations, directives and related national laws in the member states and provide Distributor with all information necessary (including information about all registrations / notifications for Products under this paragraph) to comply with such regulations, directives and national laws.

Supplier warrants that the Product, including the whole package & all enclosed items delivered together with the products, also of 3rd parties, does not contain any substances that are prohibited or restricted in the EU /UK / EMEA countries above legally permitted thresholds and is in conformity with all applicable marking / labelling provisions and information obligations including but not limited to the crossed out wheeled bin, heavy metal symbols, date marks, name & address of the manufacturer / importer, product identification (e.g. serial number), as well as all applicable CE, UKCA and any other markings. Supplier further warrants that, where applicable, it has carried out relevant conformity assessment procedures required by CE, UKCA and any other legislation requiring conformity assessment, drawn up technical documentation and accompanied the Product with all legally mandatory information / documents such as instructions / installation manuals, safe use information, declaration of conformity (DoC) etc.

Packaging & labeling requirements

ESD & MSD labeling and marking

Product labeling and marking in containers shall include any product specific and commonly practiced applicable standards like e. g. JESD 625, ANSI ESD S20.20 or IEC 61340-5-1 et seq. for ESDS (electrostatic discharge sensitive devices) or MSD (moisture sensitive devices) stipulated by JEDEC J-STD-033, JEDEC J-STD-020, EIA/JEP 113 and JEP130 in their latest revision and always including their quoted reference- or co-effective documents.

Packaging of electronic parts and components

In principle, all electrostatic endangered components and devices have to be packed according to the requirements of the JESD 625, ANSI ESD S20.20 or IEC 61340-5-1 et Seq.

Packaging materials have to be:

- Free of Foreign Object Debris (FOD).
- Qualified for the use in ESD protected areas.
- Inside the package electrostatic sensitive components and/or devices must not charge electro statically.
- The contact with electrostatically charged persons or items must not damage or destroy the components and/or devices inside the package.
- The package must protect against intrusion or impact of electric fields in an ESD compatible way.

Avnet label requirements

As a member of the Electronic Components Industry Association (ECIA), Avnet expects suppliers to develop barcode labels in line with the ECIA publication EIGP 114.2018. These require Barcode technology to code 39, 128, PDF 417 or ECC-200. All barcoded and human readable information must be on the various packaging levels and documentation as defined in the "Overview about Barcode / Human readable / 2D Barcode Features" table on the following page.

Note:

2D barcodes are clearly the very standard service level required by Avnet EMEA, whilst 1D-coded or human readable information can only be accepted in exceptional cases and upon prior approval by the concerned Logistics Centre.

Avnet logistics 1D labeling requirements for inbound products (if 2D labelling is not possible)

The following criteria must be followed for all inbound orders to all Avnet Logistic Centers:

- Only one purchase order line item may be shipped per packing slip.
- Each line item must have its own packing slip.
- For each line item in a purchase order where multiple boxes of the same part number are shipped, the packing slip will be affixed to Box #1 of xx.
- All boxes in a single line item must be consolidated (grouped) together in the same external carton or on the same pallet.
- Only one lot code and/or date code will be shipped per packing slip.
- Country of Origin must be present and barcoded on internal labeling, packing slip as well as on all product packaging.
- System generated RoHS product status must be identified using JESD 97. All elements barcoded in Label 1 must be barcoded in code 39 or 128 and human readable. Code 128 is preferred.
- “RoHS Comp” or “RoHS Compliant” terminology is acceptable should it apply directly. Product that is RoHS compliant utilizing an exemption should be identified as “RoHS Exemption” followed by number of exemptions.
- “REACH SVHC contained” followed by name of contained SVHC in human readable format.

Where applicable to the products Avnet EMEA requires from its Suppliers weekly date codes as stipulated in “ECIA Weekly Date Codes” (YYWW) for the components – this clearly means each date code specified with its individual quantities contained.

DATA identifier	Field Name / Attribute	Logistics label (1)	Intermediate label (2)	Product label (3)	Packing Slip (4 & 5)
4L	Country of Origin (to ISO 3166-2)	B/H/2D	B/H/2D	B/H/2D	B/H/2D
Q	Quantity (no separator e.g., 4500 not 4,500)	B/H/2D	B/H/2D	B/H/2D	B/H/2D
	Established Reliability (E/R) identification – When applicable	H			H
E	RoHS Indicator – Symbol Ref. J-STD-609B or “RoHS conforming” verbiage	B/H/2D	B/H/2D	H	H
	REACH SVHC information	H	H	H	H
	CE Marking	H	H	H	H
	Battery containment information	H	H	H	H
	Lithium Battery	H	H	H	H
	Moisture Sensitive Level – When applicable per J-STD-033	H	H	H	H
	TEMP – Peak body/reflow temperature – When applicable	H	H	H	H
13Q	Package Count – e.g., 1 of2, 2 of2	B/H/2D		H	B/H/2D
11K	Packing Slip / Delivery Note Number	B/H/2D			B/H/2D
1P	Supplier Part Number	B/H/2D	B/H/2D	B/H/2D	B/H/2D
P	Customer (Avnet) Part Number	B/H/2D	B/H/2D	B/H/2D	B/H/2D
3S	Package / Bulk ID		B/H/2D		
4S	Package / Bulk ID	B/H/2D			
5S	Package / Bulk ID (mixed items)	B/H/2D			
9D / 10D	Product Date Code – Packages with multiple date codes on one line item must identify each date code together with its respective quantity or in exceptional cases at least list the oldest date code immediately followed by an “M” designating multiple date codes inside	B/H/2D	B/H/2D	B/H/2D	B/H/2D

1T	Product Lot / Trace Codes	B/H/2D	B/H/2D	B/H/2D	B/H/2D
33P	Luminosity Rank – When applicable	B/H/2D	B/H/2D	B/H/2D	B/H/2D
K	Purchase Order Number	B/H/2D	B/H/2D		B/H/2D
4K	Purchase Order Line Number	B/H/2D	B/H/2D		B/H/2D
S	Serial Number – When applicable		B/H/2D	B/H/2D	B/H/2D
	Ship from Address	H	H		H
	Ship to Address	H	H		H
	Waybill Number	H	H		H
	Weight (followed by UoM (unit of measurement))	B/H/2D			B/H/2D

Legend:

B = (1D-) Barcode

H = Human Readable

2D = 2D-Barcode

“ ; ” or “ @ ” = Separator (represented either by ;-Symbol or @-Symbol)

Font style:

Regular (1D-Barcode): Exceptional service level, upon prior approval only

Bold (2D-Barcode): Required standard service level

Approved 2D labels:

- The format for the 2D barcode includes requirements for 1D back up information in the event the 2D is damaged or not readable.
- The data structure used to create the 2D data string is based on the selected scanning hardware and current Avnet system guidelines.
- Different field separator characters and data identifiers are utilized for compatibility with the scanning hardware used by Avnet.
- PDF417 and Data Matrix ECC-200 are the accepted format options for 2D product labels.

Product packaging label requirements

Individual box shipments (logistics label):

These orders are separate line-item orders shipped separately on the carrier and not consolidated.

The packing slip must be affixed to each order or box #1 of multi-box orders. Orders shipped in this manner are considered to be in external packaging and must be labeled per **LABEL 1**.

Figure 1:

- Affix Label 1 to all boxes in the line item.
- All multi-box orders must be grouped together on the same pallet.
- Packing slips must be attached to box # 1 of all multi-box line items/orders. Product labels must be affixed per Figure 3.

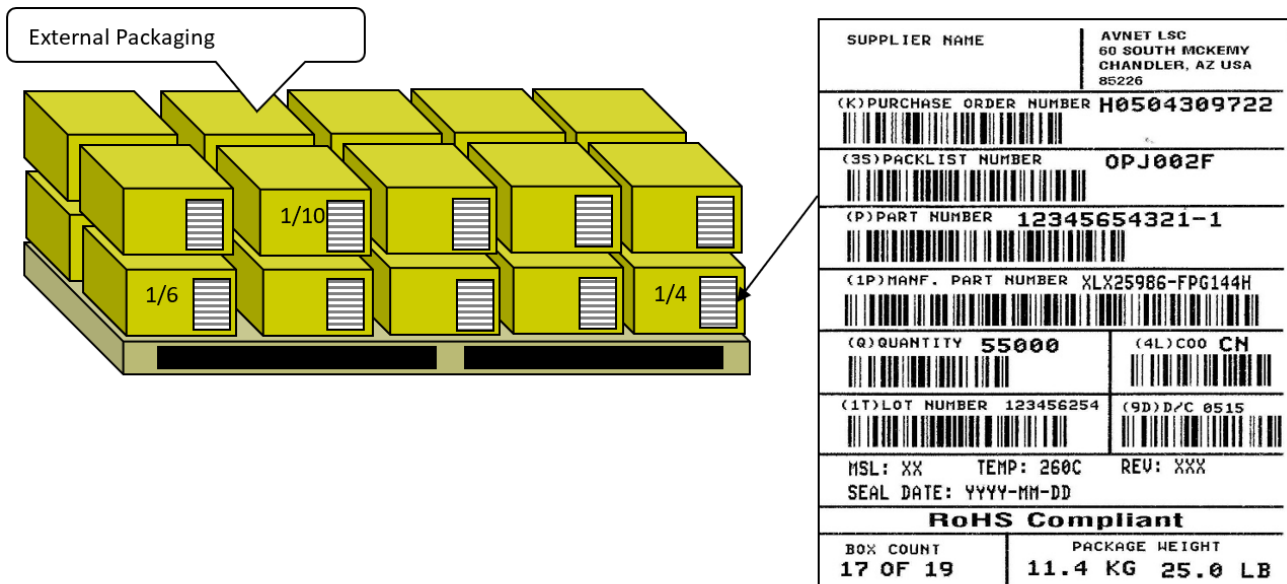

LABEL 1

LABEL 1 explanation and requirements (barcode/human readable/2D – B/H/2D)

- (K) Purchase Order: Avnet Purchase Order Number without spaces or hyphen (B/H/2D)
- (4K) Purchase Order Line-Item Number without spaces or hyphen (B/H/2D)
- (P) Customer (Avnet) Part Number (if applicable): Avnet defined part number for the product (B/H/2D)
- (1P) MFG. Part Number: Required and must match part number ordered exactly for scanning purposes if Avnet part number is not available (B/H/2D)
- (Q) Quantity: All quantity labels must only reflect actual box quantity. Total line item/packing slip quantity can be noted on Label 1 but must be identified as Pack Slip Qty. Only! (B/H/2D)
- (4S) Package / Bulk ID Number: Unique Identification number assigned by the supplier that allows traceability for receipt discrepancies related to purchase orders and inbound quality issues (B/H/2D)
- (9D, 10D) Date Code - Product creation date (not product ship date): Supplier date code in the YYWW format (B/H/2D)
- (4L) Country of Origin: 2 Character ISO 3166 format required (B/H/2D)
- (1T) Lot Code/Number: Only one lot code and date code per line item and part number (B/H/2D)
- (E) RoHS Status level (B/H/2D)
- (33P) Luminosity grade where applicable ((B/H/2D)
- (13Q) Package count: Number of box in relation to total boxes in shipment (B/H/2D)
- (11K) Pack Slip / Delivery Note Number: Unique alphanumeric number assigned by the supplier (B/H/2D)
- Package weight: LBS and Metric required (H)
- MSL: Moisture Sensitive Level (according to JEDEC 033) where applicable (H)
- TEMP: Peak Body / reflow temperature where applicable (H)
- CE/REACH/Lithium Battery information where applicable (H)

Consolidated orders:

These orders are separate line-item orders that are placed in a larger (external) container for shipping purposes. The larger external container must be labeled to identify that a mixed load is contained inside the larger carton.

When consolidating orders, packing slips must be affixed to each single internal box order or box # 1 on multiple box orders. Individual boxes packed in consolidated shipments should be labeled per **LABEL 1**.

Figure 2:

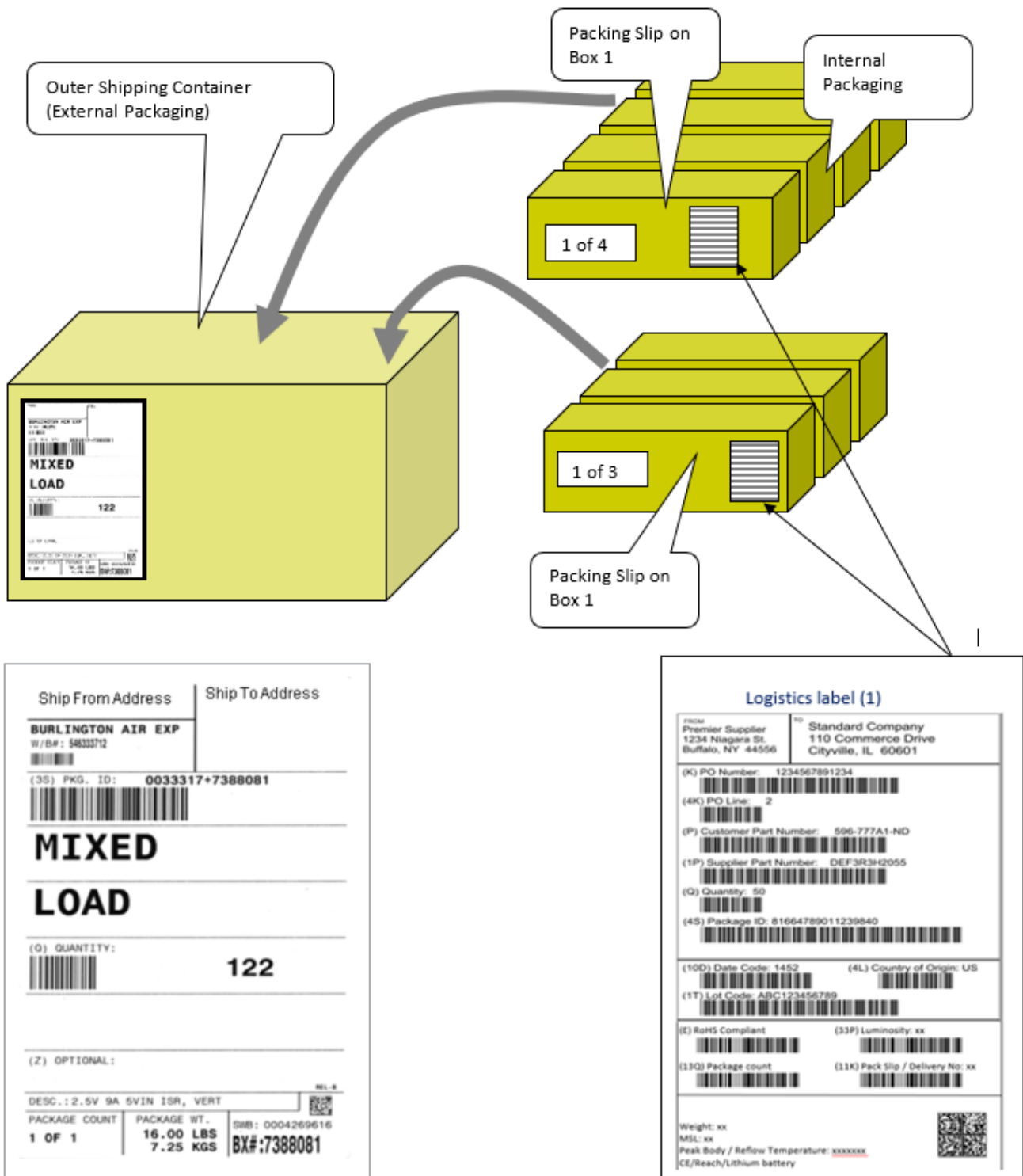

Intermediate product packaging

A single carton or package defined by the supplier that provides means of protection for transportation, storage and identification. Typical examples are cartons containing single reels, tubes, trays or bulk bag packaged components. These cartons should be labeled as per Label 2.

Figure 3

- Product packaging must show the total box quantity on the product packaging.
- A Product Label (Label 3) must be on all reels, dry packs and bulk bags or boxes.

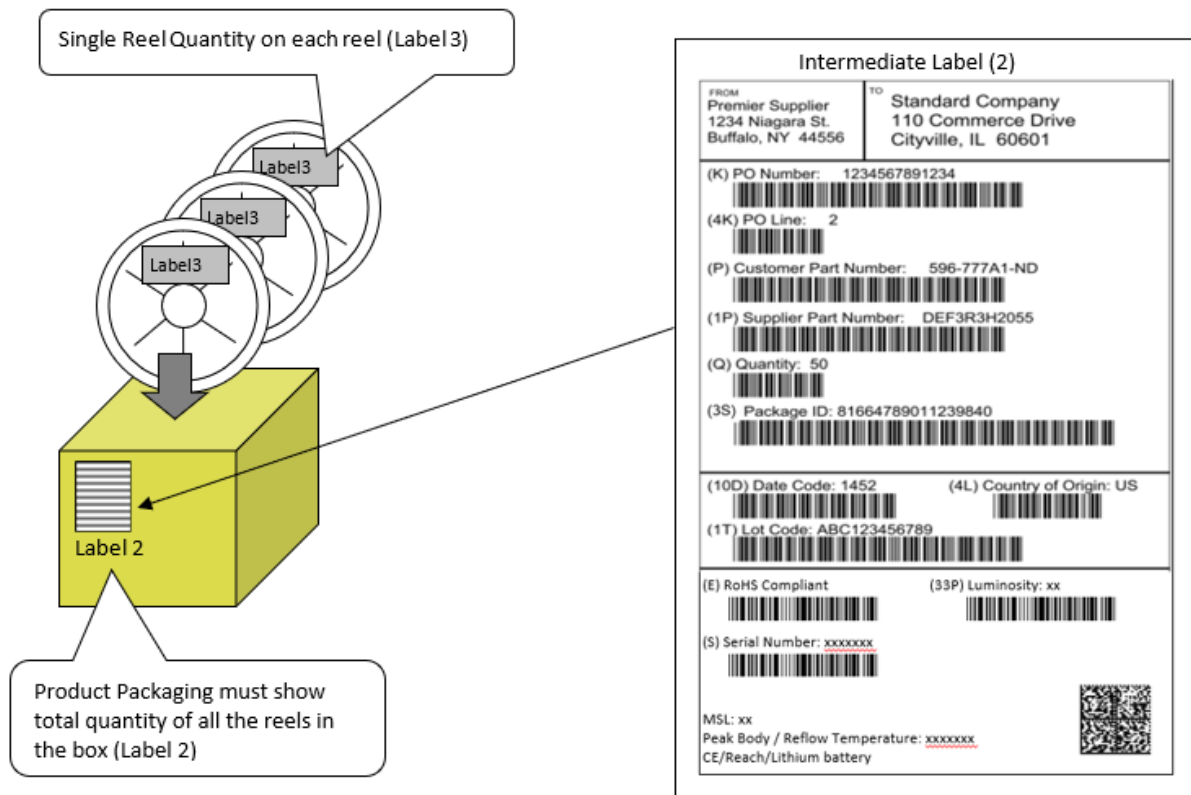

LABEL 2 explanation and requirements (barcode/human readable/2D – B/H/2D)

- (K) Purchase Order: Avnet Purchase Order Number without spaces or hyphen (B/H/2D)
- (4K) Purchase Order Line-Item Number without spaces or hyphen (B/H/2D)
- (P) Customer (Avnet) Part Number (if applicable): Avnet defined part number for the product (B/H/2D)
- (1P) MFG. Part Number: Required and must match part number ordered exactly for scanning purposes if Avnet part number is not available (B/H/2D)
- (Q) Quantity: All quantity labels must only reflect actual box quantity. Total line item/packing slip quantity can be noted on Label 1 but must be identified as Pack Slip Qty. Only! (B/H/2D)
- (3S) Package / Bulk ID Number: Unique Identification number assigned by the supplier that allows traceability for receipt discrepancies related to purchase orders and inbound quality issues (B/H/2D)
- (9D, 10D) Date Code - Product creation date (not product ship date): Supplier date code in the YYWW format (B/H/2D)
- (4L) Country of Origin: 2 Character ISO 3166 format required (B/H/2D)
- (1T) Lot Code/Number: Only one lot code and date code per line item and part number (B/H/2D)
- (E) RoHS Status level (B/H/2D)
- (33P) Luminosity grade where applicable ((B/H/2D)
- (S) Serial Number where applicable (B/H/2D)
- MSL: Moisture Sensitive Level (according to JEDEC 033) where applicable (H)
- TEMP: Peak Body/reflow temperature where applicable (H)
- CE/REACH/Lithium Battery information where applicable (H)

Product (lowest level) packaging

A single unit defined by the supplier that provides means of protection for transportation, storage, and identification. Typical examples are: Single reels, packs of trays or tubes, and bagged or boxed components that would be loose without the bag or box. These units should be labeled as per Label 3

Figure 4

- A Product Label (LABEL 3) must be on all reels, dry packs and bulk bags or boxes.

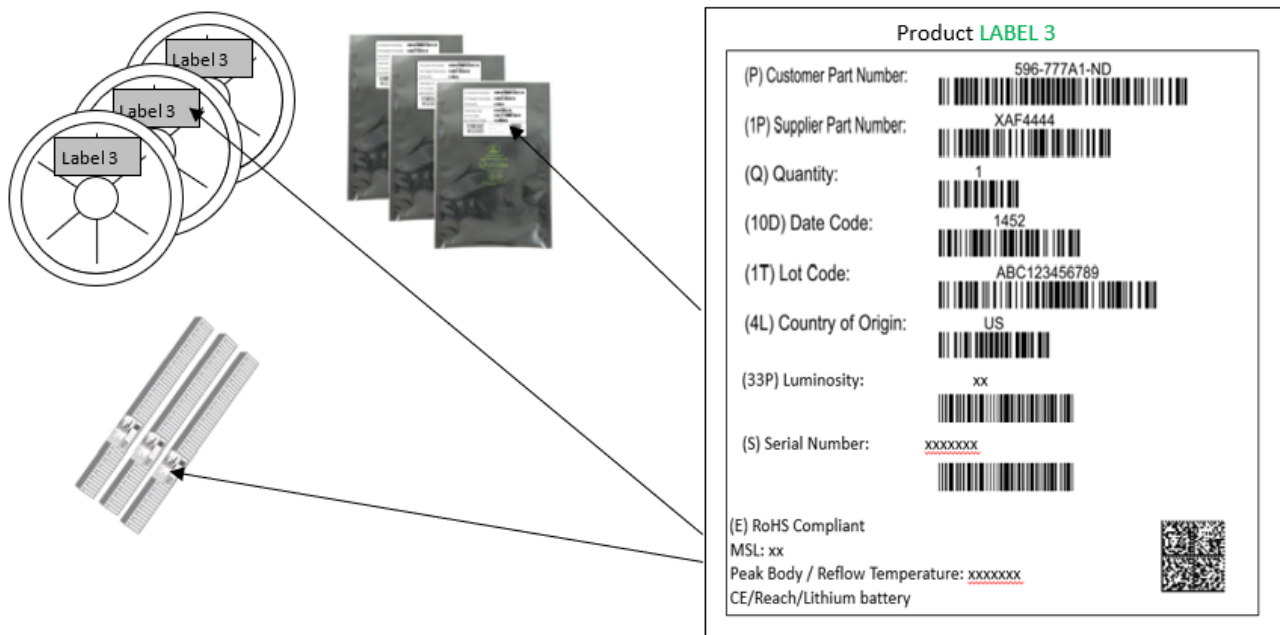

When the device is too small to mark with the manufacturer part number Avnet requires some form of marking to be present on the part and on *Label 3* as a reference between such marking and the part number.

LABEL 3 explanation and requirements (barcode/human readable/2D – B/H/2D)

- (P) Customer (Avnet) Part Number (if applicable): Avnet defined part number for the product (B/H/2D)
- (1P) MFG. Part Number: Required and must match part number ordered exactly for scanning purposes if Avnet part number is not available (B/H/2D)
- (Q) Quantity: Quantity in single bag or reel (B/H/2D)
- (9D or 10D) Date Code: Format YYWW required (B/H/2D)
- (1T) Lot Code: where applicable (B/H/2D)
- (4L) Country of Origin: 2 Character ISO 3166 format required (B/H/2D)
- (33P) Luminosity grade where applicable ((B/H/2D)
- (S) Serial Number where applicable (B/H/2D) MSL: Moisture-Sensitive Level when required (H)
- (E) RoHS Status level (H)
- MSL: Moisture Sensitive Level (according to JEDEC 033) where applicable (H)
- TEMP: Peak Body or Solder Temperature (H)
- CE/REACH/Lithium Battery information where applicable (H)

Palletized shipments

- Multiple shipments of the same part number shipped in the same day must be consolidated. When a single purchase order line item is part of a shipment of multiple items, whether of the same purchase order line item, different line items or different purchase orders, the box shall be identified with a package count.
- Multiple box shipments will be consolidated and shipped in such a manner to assure same day/time delivery of all boxes.
- Boxes will be sealed by the Supplier to ensure count and part type integrity.
- Warning labels, electrostatic discharge caution label, moisture sensitive caution labels, safety warnings, special handling requirements, HAZMAT labeling etc. must be prominently displayed on the outside of each box
- Palletized shipments must be on EURO pallets as standard.

Completely packed pallets must not exceed the following dimensions:

- Length x width x height (in cm) = 120 x 80 x 180
- Maximum weight of a loaded pallet is 600 kg (1320lb).
- Pallet must not have any damage to spars in either direction.

All additional packaging materials for protection of the goods have to be made of fully recyclable material. Materials like cardboard, paper and wood are acceptable (Materials like wood wool, Styrofoam, Styrofoam chips, newsprint, etc. are not acceptable).

- The package on the pallet must not protrude the pallet border.
- The loading unit has to be strapped in both directions. This has to be done through the pallet bottom but not under the spars.
- Before strapping, the package units have to be protected through an overlay edge protection angle made of paperboard, plastics, or steel plate (rounded corners)
- Loading units must always form a closed cover to ensure the stacking of several loading units on top of each other.

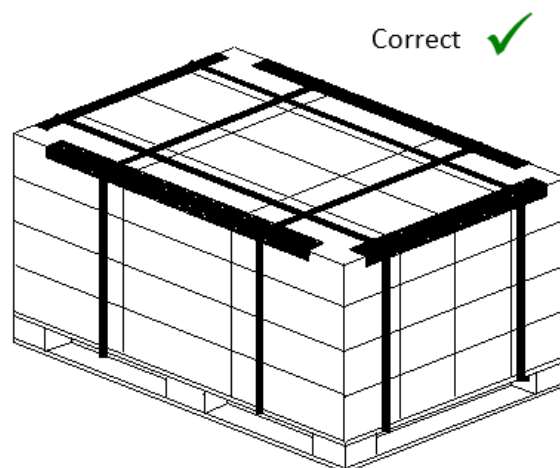
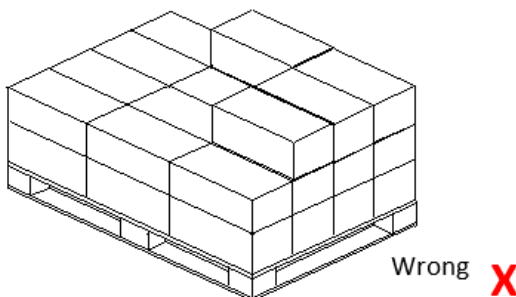
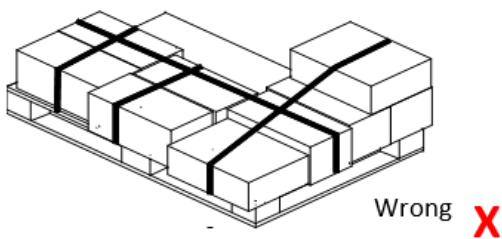

Application of covering box (corrugated pallet box)

If several packages of different sizes are shipped on one pallet, a corrugated paper container will have to be used as covering box. The empty spaces between the packages have to be filled with appropriate filling material, e.g., crinkled cardboard or empty boxes (if empty boxes these must be marked to indicate that they are empty).

Wood wool, Styrofoam chips and newsprints are not acceptable as they do not provide sufficient safety and stability of the loaded units.

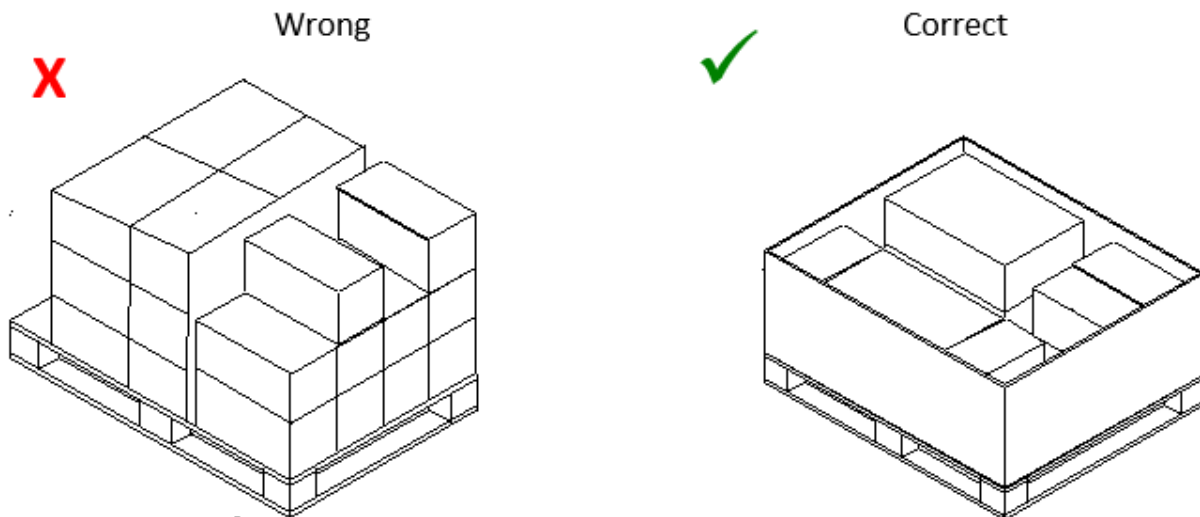

It is important that the package does not protrude the container border. Thus, the pressure can be absorbed while stacking containers.

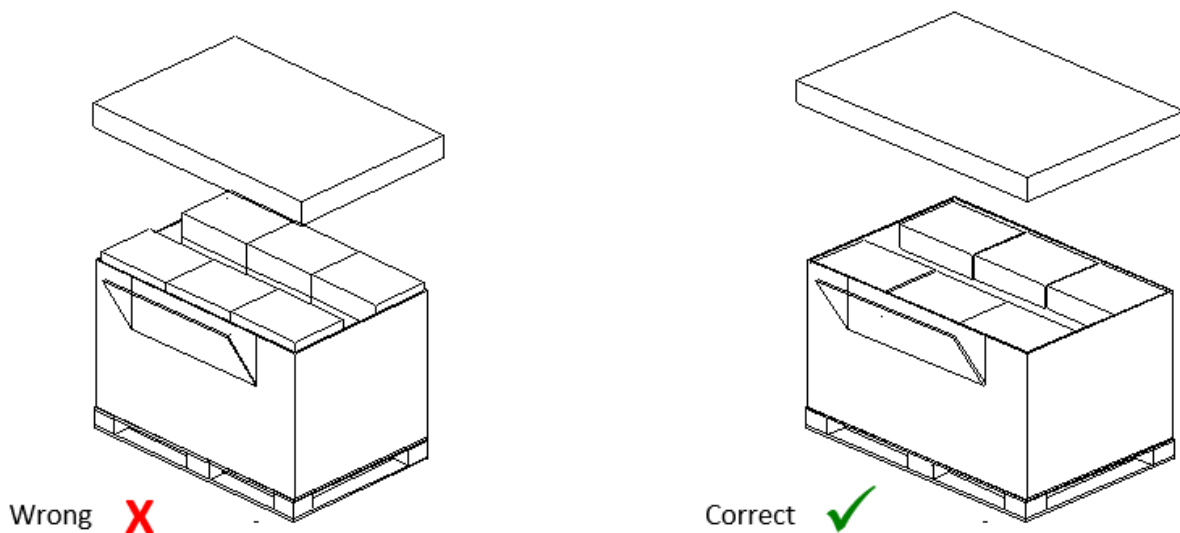

Stacking of pallets

Please follow this instruction when stacking pallets and loading equipment during transportation or storage:

- Stacking only on closed top layers with secured edges
- Note the bearing capacity of the package material at stacking (possibly an indication of top to bottom compression strength of the material)
- To place and to pay attention to warning notices or restrictions for stacking
- Heavy pallets belong to the bottom, light weighted pallets to the top

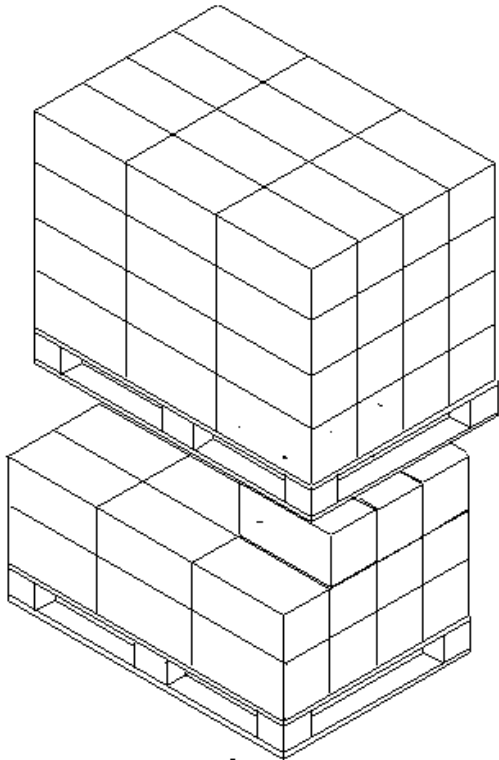

X

Wrong

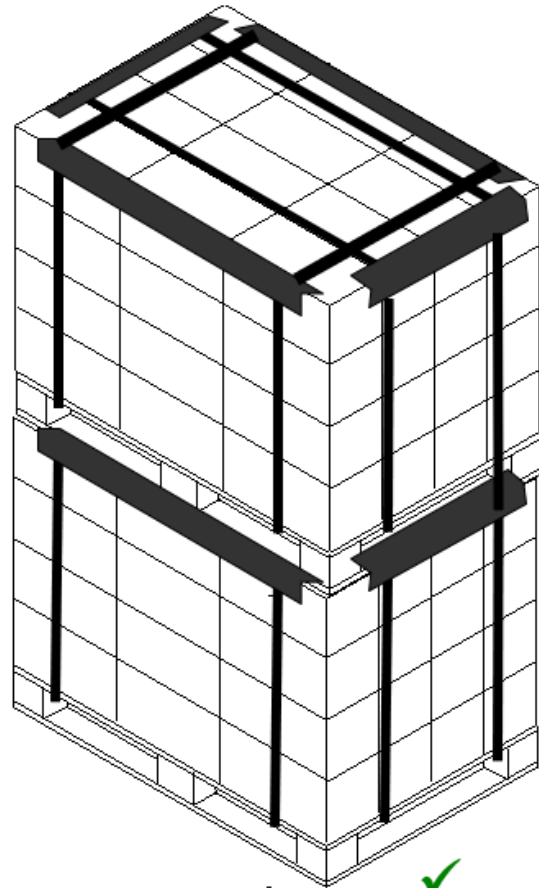

✓

Correct

Labeling of pallets

The pallets must be labeled clearly legible with article number as well as quantities.

If there are different articles on the pallets, then they should be identified by an A4 or large label indicating the inscription "Mixed pallet".

The content of the mixed pallet must be identified on a packing list which is attached at the outside of the pallet.

In case of multiple pallet delivery for the same product each pallet should be marked with number of the pallet and total pallet delivery (e. g. Pallet 1 of x pallets).

Pallet exchange

The exchange of EURO standard pallets is possible if only faultless pallets are delivered.

Delivery documents – general

- Only one purchase order will be shipped per box with one packing slip.
- The delivery documents (delivery note, pack slip, etc.) are to be attached to the outside of the box or pallet and should be in a protective envelope marked "Packing Slip", "Documents enclosed" or equivalent.
- Before unloading the freight forwarder documents must be handed over to the receiving operator in the goods receiving area.
- For deliveries on pallets the freight forwarder document must state the total weight of the pallet and the number of boxes on the pallet.
- When multiple containers of the same P.O. are shipped, the packing slip should be attached on Box 1. Copies of the packing slip should be placed inside of each of the additional containers.

Delivery documents – content

The delivery documents should contain information in barcode and human readable text. These can be a single document for 1 item or a consolidated packing slip for multiple items as shown below:

Pack slip / Delivery Note (single)	
FROM Premier Supplier 1234 Niagara St. Buffalo, NY 44556	TO Standard Company 110 Commerce Drive Cityville, IL 60601
(K) PO Number: 1234567891234 	(4K) PO Line: 1
(P) Customer Part Number: DK-DEFH777A1 	
(1P) Supplier Part Number: DEF3R3H2055 	
(11K) Packing Slip: 123456 	(Q) Quantity: 450
(10D) Date Code: 1052 	(4L) COO:US
(1T) Lot Code:123456 	
(33P) Luminosity: xx 	(S) Serial Number: xxxxxxxx
(13Q) Package count 	
(E) RoHS Compliant MSL: xx Peak Body / Reflow Temperature: xxxxxxxx CE/Reach/Lithium battery	

Pack slip / Delivery Note (multi)	
Premier Supplier Packing Slip	
FROM Premier Supplier 1234 Niagara St. Buffalo, NY 44556	TO Standard Company 110 Commerce Drive Cityville, IL 60601
(K) PO Number: 123456789 	(11K) Packing Slip: #1645654654
(P) Customer Part # SB1235445 	(4K) Customer PO Line: 1
(1P) Supplier Part # DEF3R3H2055 	(1T) Lot Code: 1234567
(10D) Date Code: 1520 	(4L) COO:US
(Q) Quantity: 10 	
(33P) Luminosity: xx 	(S) Serial Number: xxxxxxxx
(13Q) Package count 	
(E) RoHS Compliant MSL: xx Peak Body / Reflow Temperature: xxxxxxxx CE/Reach/Lithium battery	

Pack slip / delivery note explanation and requirements (barcode/human readable/2D – B/H/2D)

- (K) Purchase Order: Avnet Purchase Order Number without spaces or hyphen (B/H/2D)
- (4K) Purchase Order Line-Item Number without spaces or hyphen (B/H/2D)
- (P) Customer (Avnet) Part Number (if applicable): Avnet defined part number for the product (B/H/2D)
- (1P) MFG. Part Number: Required and must match part number ordered exactly for scanning purposes if Avnet part number is not available (B/H/2D)
- (Q) Quantity: All quantity labels must only reflect total line item/packing slip quantity (B/H/2D)
- (9D, 10D) Date Code - Product creation date (not product ship date): Supplier date code in the YYWW format (B/H/2D)
- (4L) Country of Origin: 2 Character ISO 3166 format required (B/H/2D)
- (1T) Lot Code/Number: Only one lot code and date code per line item and part number (B/H/2D)
- (33P) Luminosity grade where applicable ((B/H/2D)
- (13Q) Package count: Number of box in relation to total boxes in shipment (B/H/2D)
- (11K) Pack Slip / Delivery Note Number: Unique alphanumeric number assigned by the supplier (B/H/2D)
- (S) Serial Number where applicable (B/H/2D)
- (E) RoHS Status level (H)
- MSL: Moisture Sensitive Level (according to JEDEC 033) where applicable (H)
- TEMP: Peak Body/reflow temperature where applicable (H)
- CE/REACH/Lithium Battery information where applicable (H)

Standard C of C requirements

C of C's (Certificate of Conformance) of Supplier to Avnet EMEA must follow the stipulations of either MIL-STD-810 or ISO 17050 or EN10204 or JESD31, they shall be legible and include the following information:

- Supplier's name and address (seller and issuer)
- Buyer's (Avnet company's) name and address

- Manufacturer Part Number (MPN)
- Avnet's part number (Customer Part Number CPN)
- Avnet's purchase order number
- Quantity
- Date/lot/trace codes (in case of mix always specifying the relevant quantities)
- Optional: Other applicable and important product specific data (MSL/PBT, CoO, luminosity, stepping, serial no. etc.)
- Statement of certification to the applicable manufacturer, military, government, and/or industry specification
- Signature of duly authorized Supplier personnel

However, where the vendor to Avnet EMEA is not the manufacturer of the goods supplied either one shall be included:

- Unique identification of such vendor's product source (like sub-supplier name & address).
- Vendor's (alternatively its subcontracting laboratory's) certification to the articles' characteristics specified in Original Component Manufacturer's (OCM's) relevant data sheet.

Hazardous goods

- All hazardous goods must be clearly marked with the appropriate warning label and packaged separately from nonhazardous goods. The first delivery of any hazardous product must be accompanied with a web address where the latest version of the relevant material safety data sheet (MSDS) is located.
- All deliveries must be in accordance with ADR/IATA/ICAO regulations
- Any delivery of hazardous goods showing damage, spillage or leakage will either be refused or, if return increase risks to the carrier, will be disposed of at supplier's expense.

Advanced Shipment Notifications (ASN's) to Avnet supplier quality

All suppliers should advise Avnet of expected deliveries at the time of shipment from the supplier. This is known as an Advanced Shipment Notification (ASN). ASN's can be in either Excel format or direct copies of the supplier's delivery/advice notes. ASN's should include as a minimum the following items:

- PO number
- PO line item
- PO specified Part number.
- Quantity
- Date code
- Country of Origin
- Box or pallet number containing each part number.

Revision history of Avnet Global Supplier Quality Manual

Date & Revision	Clause(s)	Description of Change	Author	Approver
18.04.2019 Rev. 1	all	Finalization for Publication	Simon Eckert	Klaus Ullmer
08.05.2019 Rev. 1	all	Final Approval and Authorization for Publication on EMEA Web Site	Simon Eckert	Slobodan Puljarevic Mario Orlandi
11.02.2020 Rev. 1	Compliance of products	Update of regulations	Klaus Ullmer	Roman Weber
01.10.2020 Rev. 2	All	Document aligned with grouping of topics and removal of duplicates. ALS Appendix streamlined to ensure measurable requirements are listed. Environmental regulations updated.	Bob Kerwin	Klaus Ullmer
18.10.2021 Rev. 3	Core values; Compliance of products; Various;	Update of core values section. Update of product compliance section. Minor corrections and updates in various clauses.	Klaus Ullmer; Roman Weber;	Bob Kerwin
31.03.2022 Rev. 4	All	OTD definition added. ALS appendix labeling requirements aligned with ECIA standard including new label requirements and examples. The labeling overview includes barcode identifiers. Pack list barcoding examples added	Bob Kerwin	Klaus Ullmer; Catherine Deere
December 2023 Rev. 5	All	Consolidation of US and EMEA supplier handbooks into one Avnet global version.	Catherine Deere, Mike Fuller, Kari Espinoza, Stacy Mendez, Daniel J. Carey, Alex luorio	Klaus Ullmer; Slobodan Puljarevic;
October 2024 Rev. 6	All	Layout update and update to the Executive Leadership titles.	Zachary Ashton, Alba Lopez, Catherine Deere	Klaus Ullmer, Catherine Deere