

XBT-1313-UV

Surface Mount

UVC LED

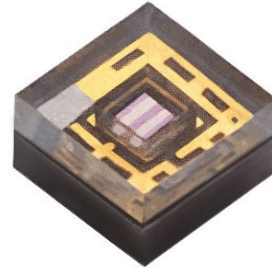

Table of Contents

Binning and Ordering	
Information.....	2
Optical and Electrical	
Characteristics	4
Mechanical Dimensions	7
Soldering Profile	8
Product Shipping & Labeling	
Information.....	9
Precautions for Use.....	11

Features:

- Latest generation XBT-1313 LED with improved packaging technology enables higher than 10 mW.
- Emission wavelength between 270 nm and 280 nm
- Ultra-compact form factor: 1.3 mm x 1.3 mm
- Wide viewing angle of 150 deg
- High reliability package with ESD protection
- Standard SMD Process
- RoHS and REACH compliant

Applications

- Air Purification
- Water Purification
- Surface Disinfection
- Medical Device Sterilization
- Appliance Sterilization
- Food & Beverage Preparation
- Horticulture

XBT-1313-UV Binning Structure

XBT-1313 LEDs are tested at a drive current of 40 mA, 40 ms single pulse and placed into one of the following radiometric flux (FF) and wavelength (WWW) and forward voltage bins.

Radiometric Flux Bins

Flux Bin (FF)	Minimum Flux (mW)	Maximum Flux (mW)
AF	2	4
AG	4	6
AH	6	8
AJ	8	10

Wavelength Bins

Wavelength Bin (WWW)	Minimum Wavelength (nm)	Maximum Wavelength (nm)
270	270	275
275	275	280

Note 1: Luminus maintains a +/- 6% tolerance on flux measurements and +/- 1 nm on wavelength measurements.

Note 2: Individual bins are not orderable. Please refer to product ordering information on page 3 for a list of ordering part numbers.

Forward Voltage Bins

Voltage Bin	Minimum Forward Voltage (V)	Maximum Forward Voltage (V)
V2	4.5	5.0
V3	5.0	5.5
V4	5.5	6.0
V5	6.0	6.5
V6	6.5	7.0
V7	7.0	7.5

Part Number Nomenclature

XBT — 1313 — UV — <A###> — <FFWW-##>

Product Family	Package Type	Spectrum	Package Configuration	Bin kit
XBT: UVC Surface Mount Package	1313 : 1.3 mm x 1.3 mm	Ultraviolet	A150 : 150 degree viewing angle	Flux and Wavelength bin kit code - See bin kit order codes table

Ordering Part Numbers

The table below lists ordering part numbers available for XBT-1313-UV LEDs. The part number includes a bin kit, a group of flux and wavelength bins described in page 2, that are shippable for a given ordering part number . Individual flux , wavelength or voltage bins are not orderable . Flux bin listed is minimum bin shipped - higher bins may be included at Luminus’ discretion.

Wavelength Range	Wavelength Bins	Radiometric Flux		Ordering Part Number
		Bin Kit Flux Code	Min. Flux	
270-280	270, 275	AF	2	XBT-1313-UV-A150-AF270-00
		AG	4	XBT-1313-UV-A150-AG270-00

Optical and Electrical Characteristics

Parameter	Symbol	Typical	Unit
Test Current	I_f	40	mA
Minimum Forward Voltage	V_{f-min}	4.5	V
Typical Forward Voltage	V_{f-typ}	6.5	V
Maximum Forward Voltage	V_{f-max}	7.5	V
FWHM	$\Delta\lambda$	10	nm
Viewing Angle	$2\theta_{1/2}$	150	°
Thermal Resistance (junction-solder point)	R_{th}	20	°C/W

Absolute Maximum Ratings

Parameter	Symbol	Value	Unit
Forward Current	I_{f-max}	100	mA
Junction Temperature	T_j	85	°C

Note 1: Ratings are based on operation at a constant junction temperature of $T_j = 25^\circ\text{C}$. Test condition is a single 40 ms pulse at 25°C .

Note 2: Luminus XBT-1313 LEDs are designed for operation up to an absolute maximum forward drive current as specified above. Product lifetime data is specified at typical forward drive currents. Sustained operation at absolute maximum currents will result in a reduction of device lifetime compared to typical forward drive currents. Actual device lifetimes will also depend on junction temperature. Refer to the current vs. junction temperature derating curves for further information. In pulsed operation, rise time from 10-90% of forward current should be larger than 0.5 microseconds.

Note 3: Caution must be taken not to stare at the radiation emitted from these UV LEDs.

Optical & Electrical Characteristics

Relative Power vs. Forward Current

$\phi/\phi_{(40\text{ mA})}$, 20 ms pulse, $T_j = 25^\circ\text{C}$

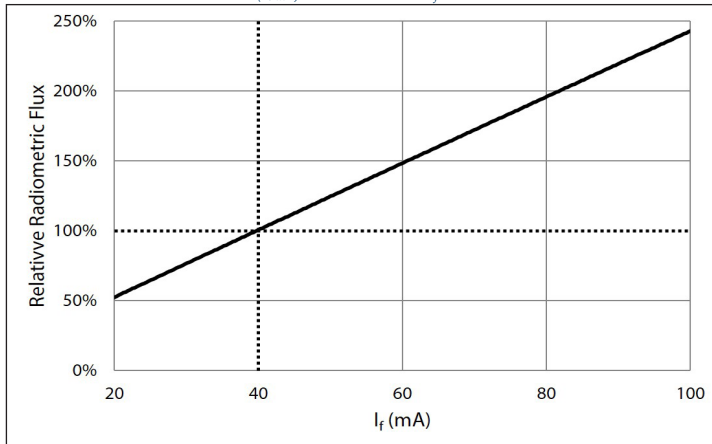

Relative Power vs. Junction Temperature

$\phi/\phi_{(25^\circ\text{C})}$, 20 ms pulse, 40 mA

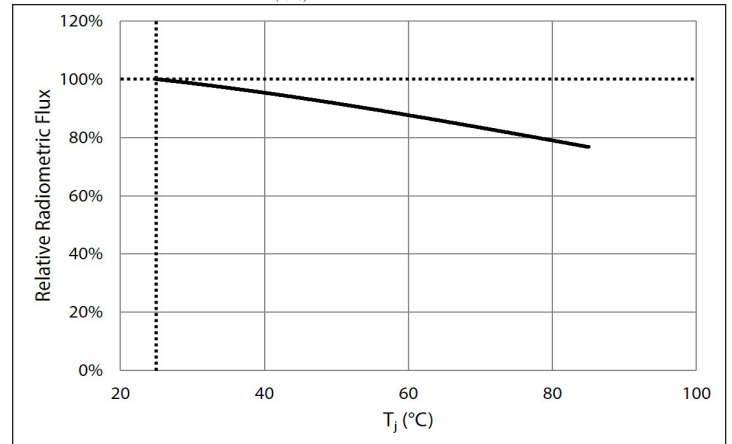

Peak Wavelength Shift vs. Forward Current

$\lambda_p = \lambda_p(I_f) - \lambda_p(40\text{ mA})$, 20 ms pulse, $T_j = 25^\circ\text{C}$

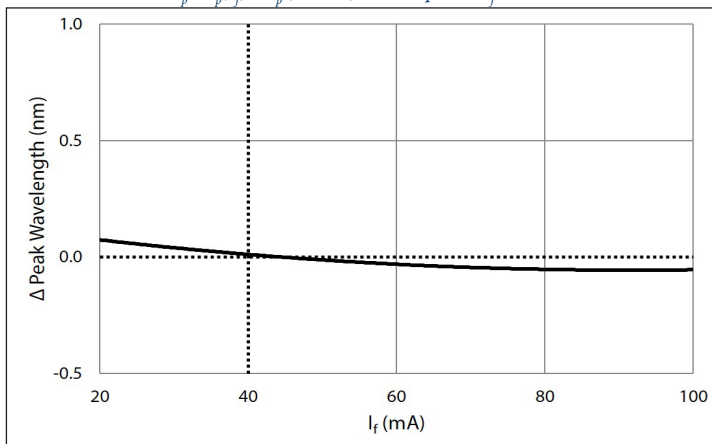

Peak Wavelength Shift vs. Junction Temperature

$\lambda_p = \lambda_p(T_j) - \lambda_p(25^\circ\text{C})$, 20 ms pulse, $I_f = 40\text{ mA}$

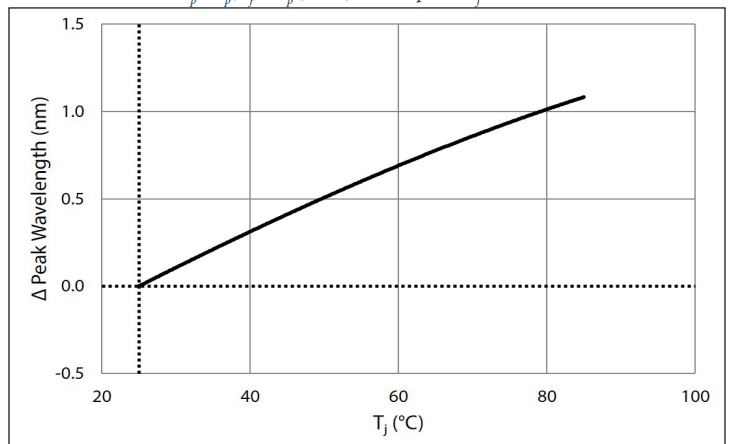

Forward Voltage vs Forward Current

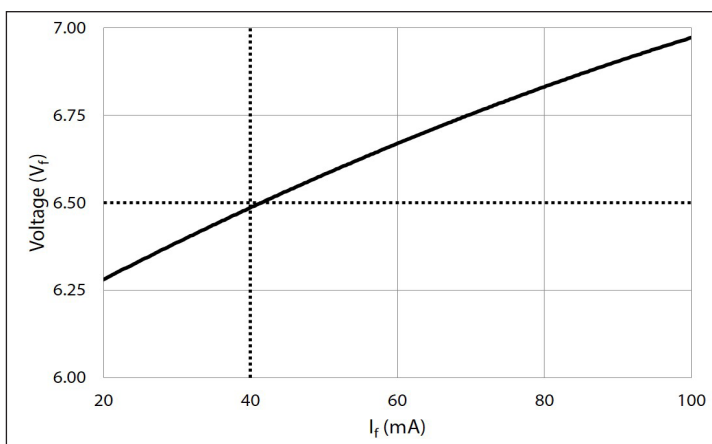

Forward Voltage Shift vs. Junction Temperature

$\Delta V_f = V_f(T_j) - V_f(25^\circ\text{C})$, 20 ms pulse, $I_f = 40\text{ mA}$

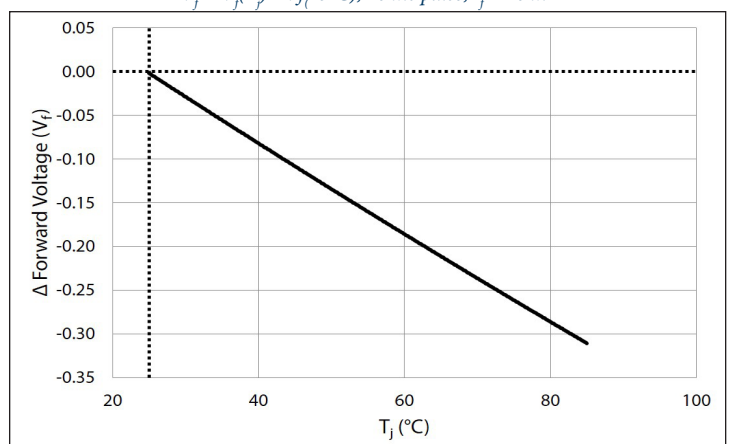

Typical Spectrum

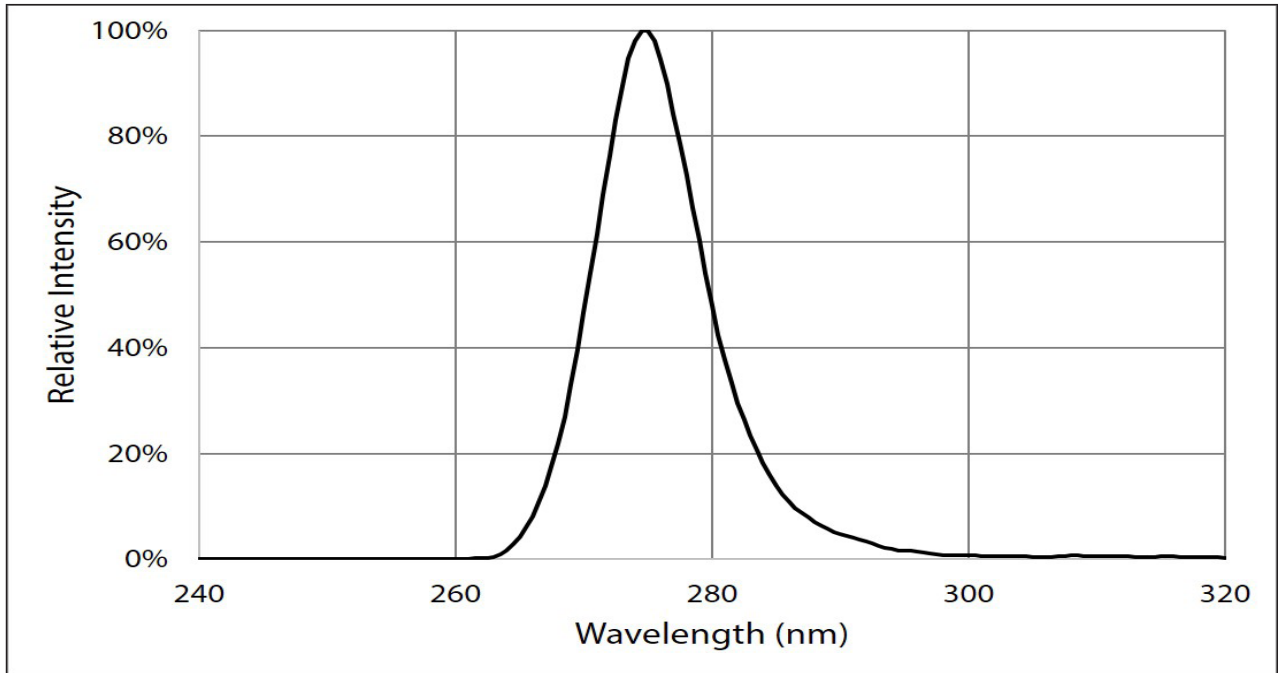

Radiation Pattern

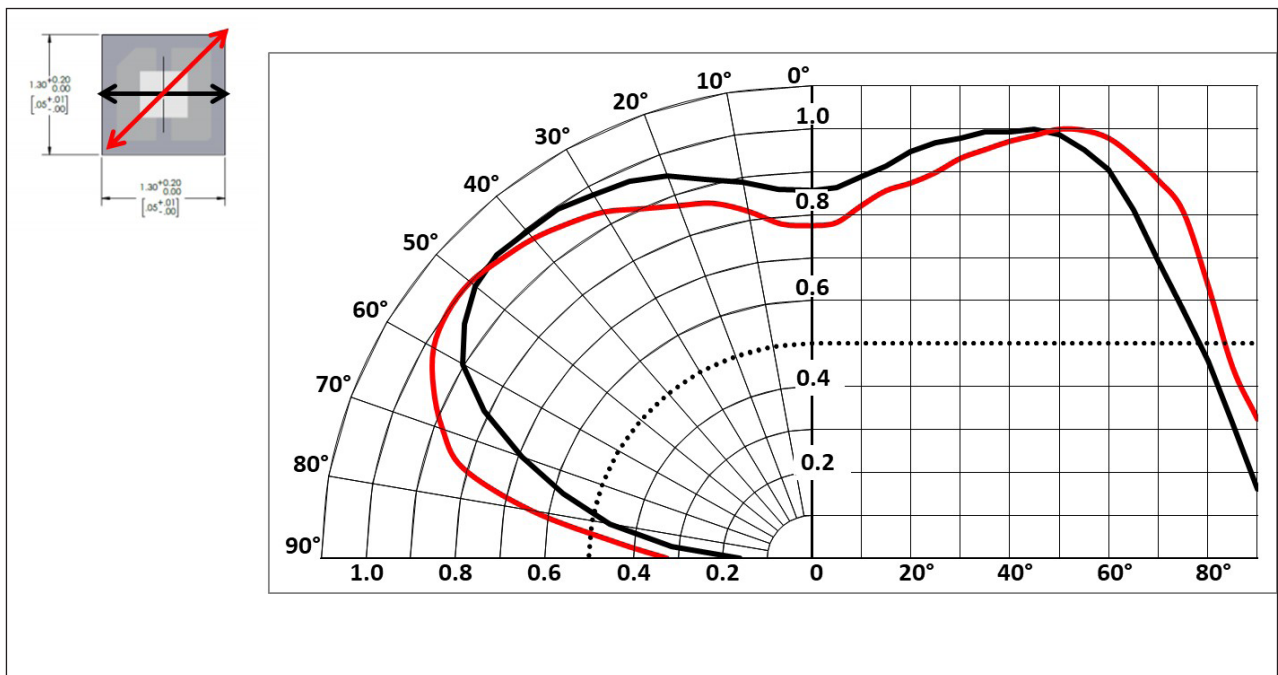

Note 1 : Typical spectrum at 40 mA drive current.

Mechanical Dimensions

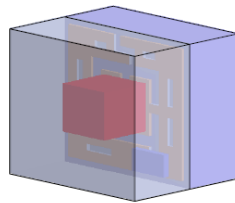
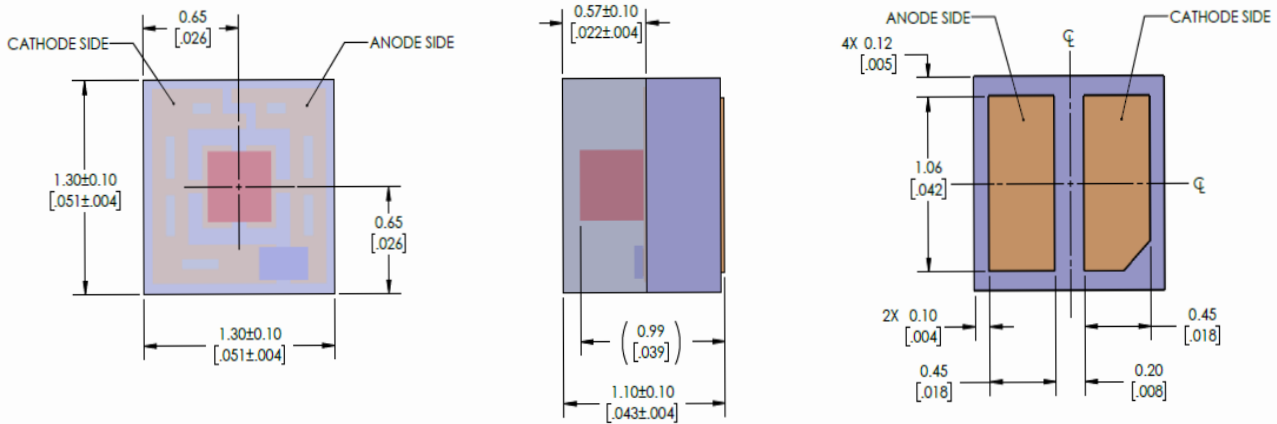

Recommended Solder Pad & Stencil Pattern

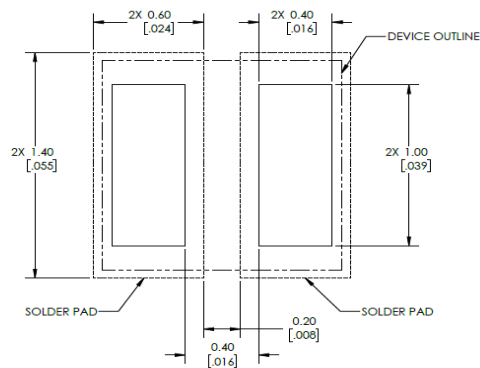
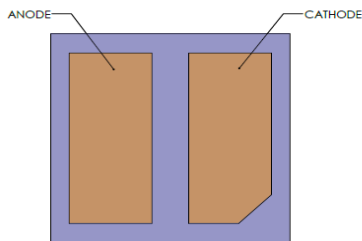

RECOMMENDED STENCIL

Solder Pad	1.4mm x 0.6mm
Stencil Pattern	1.0mm x 0.4mm

Soldering Profile

Profile Setting	Pb-Free Profile
Average Ramp-up Rate ($T_{s_{max}}$, T_p)	1 °C/sec
Preheat Temperature Min ($T_{s_{min}}$)	100-150 °C
Preheat Temperature Max ($T_{s_{max}}$)	180-200 °C
Preheat Time ($t_{s_{min}}$ to $t_{s_{max}}$)	60-120 sec
Liquidus Temperature (T_L)	217 °C
Time Maintained Above T_L (t_L)	50-80 sec
Peak / Classification Temperature (T_p)	260 °C
Time within 5°C of Actual Peak Temp (t_p)	Max 10 sec
Ramp-Down Rate	2-3 °C /sec
25°C to Peak Temperature time	4 mins

Luminus recommends that users follow the recommended soldering profile provided by the manufacturer of the solder paste used. Note that this general guideline may not apply to all PCB designs and configurations.

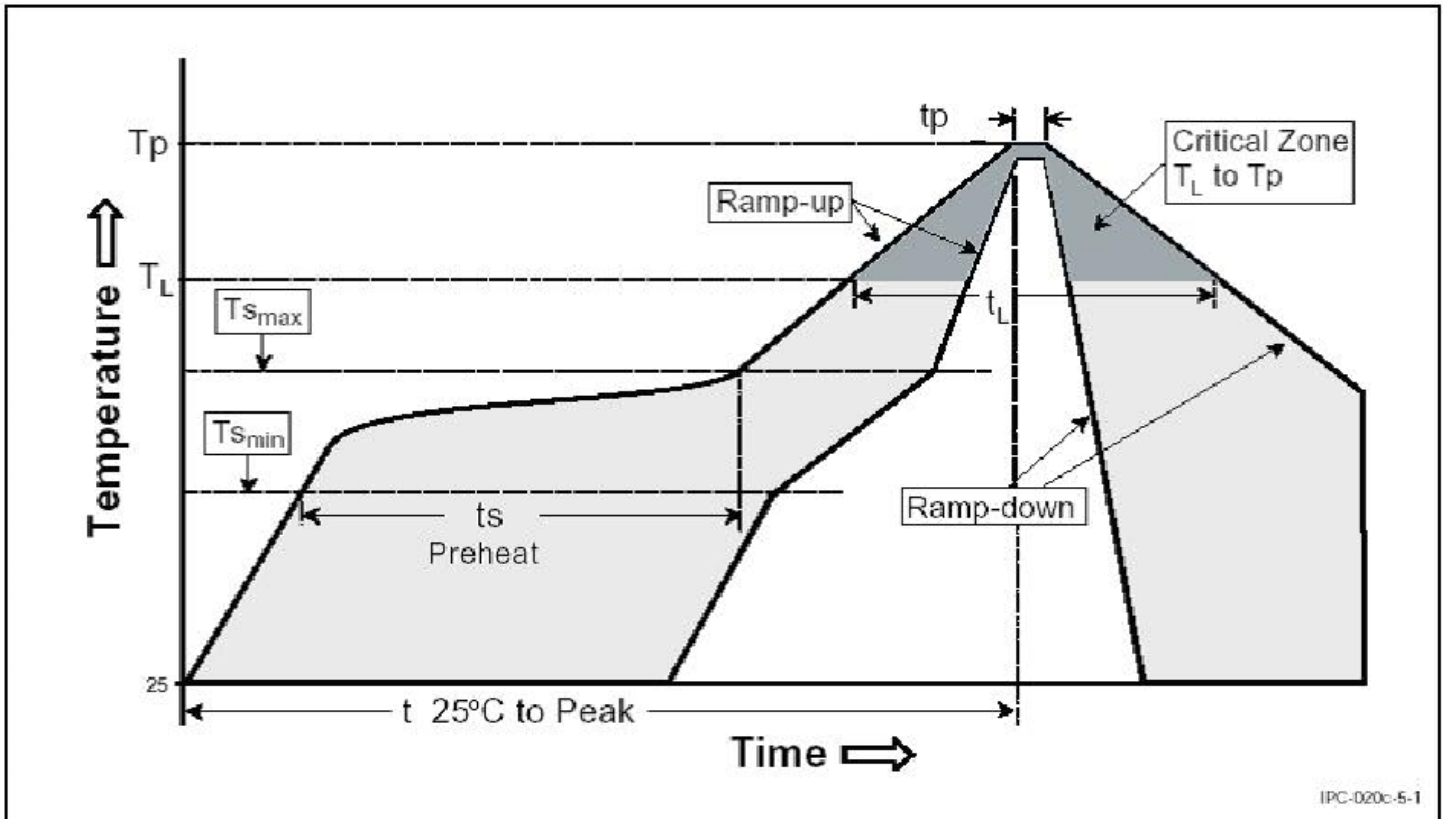

Product Shipping & Labeling Information

All XBT-1313 products are packaged and labeled with their respective bin as outlined in the tables on pages 2 & 3. Each reel will only contain one flux and one wavelength bin

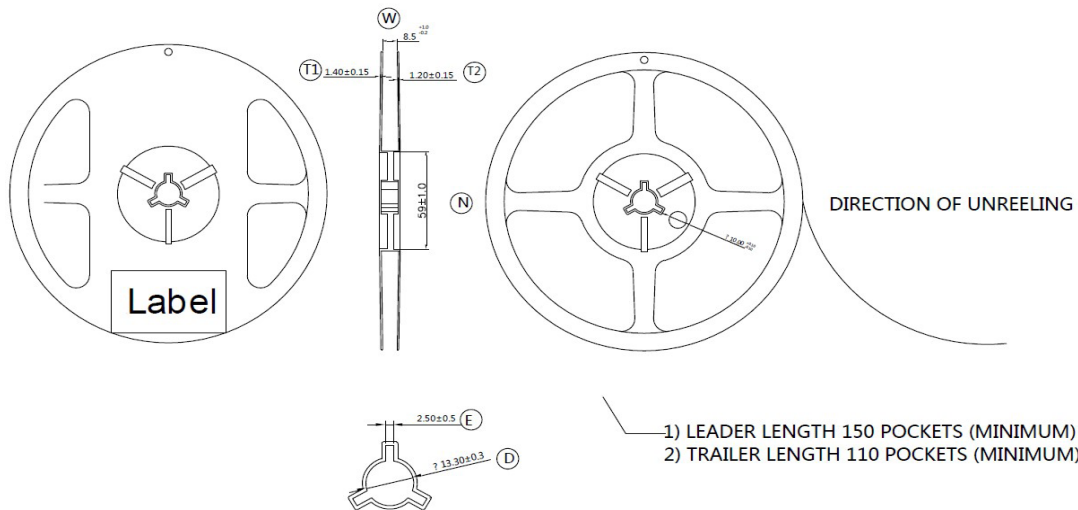
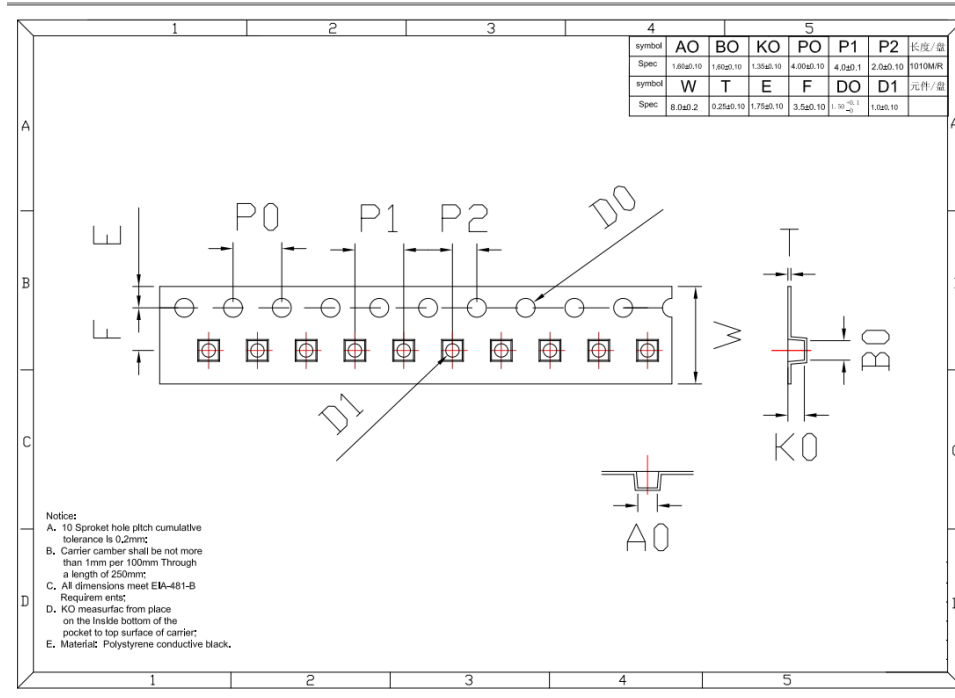

Product Shipping & Labeling Information

All XBT-1313 products are packaged and labeled with their respective bin as outlined in the tables on pages 2 & 3. Each reel will only contain one flux and one wavelength bin

XBT-1313-UV Label Information

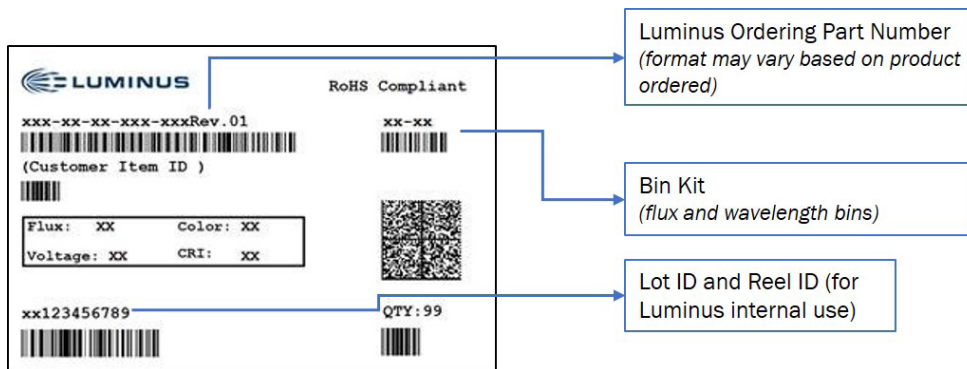

Precautions for storage, handling and use of UV LED components

1. UV Light

XBT-1313-UV LEDs are short wavelength, deep UV LEDs. During operation, the LED emits high intensity UVC radiation, which is harmful to skin and eyes. UV light is also hazardous to skin and may cause cancer. Avoid exposure to deep UV light when LED is operational.

Precautions must be taken to avoid looking directly at the UV light without the use of UV light protective glasses. Do not look directly at the front or at the LED's lens when LED is operational.

2. Static Electricity (ESD)

While XBT 1313 LEDs have built-in protection, they are sensitive to ESD (Electrostatic Discharge). Static electricity and surge voltages seriously damage UV LEDs and can result in complete failure of the device. Precautions must be taken against ESD when handling or operating these devices.

3. Operating Conditions

In order to ensure the correct functioning of these LEDs, compliance to maximum allowed specifications is important. UV LEDs are particularly sensitive to drive currents that exceed the max operating specifications and may be damaged by such drive currents. The use of current regulated drive circuits is strongly recommended when operating these devices. Customers should also provide adequate thermal management to ensure LEDs do not exceed maximum recommended temperatures. Operating LEDs at temperatures in excess of specification will result in damage and possibly complete failure of the device.

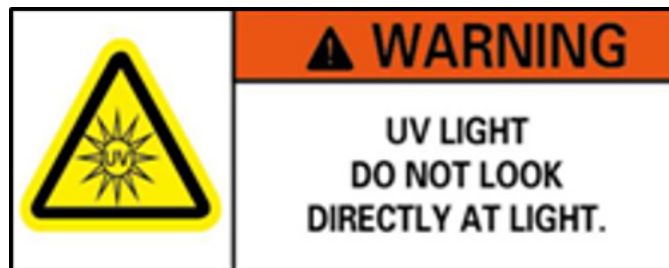

The products, their specifications and other information appearing in this document are subject to change by Luminus Devices without notice. Luminus Devices assumes no liability for errors that may appear in this document, and no liability otherwise arising from the application or use of the product or information contained herein. None of the information provided herein should be considered to be a representation of the fitness or suitability of the product for any particular application or as any other form of warranty. Luminus Devices' product warranties are limited to only such warranties as accompany a purchase contract or purchase order for such products. Nothing herein is to be construed as constituting an additional warranty. No information contained in this publication may be considered as a waiver by Luminus Devices of any intellectual property rights that Luminus Devices may have in such information.