

# The Effect of Surge Testing Live Online for Surge Protective Devices

## WHITE PAPER

### INTRODUCTION

Overvoltage protection components and devices for AC power lines are commonly qualified against the UL 1449 standard. UL 1449 serves the industry by providing a uniform evaluation of minimum safety performance parameters as well as setting minimum requirements for various ratings. However, some of the simulated lightning surge tests prescribed in UL 1449 do not appear to provide a close correlation to actual device performance expected in actual field use conditions. For example, the nominal discharge current tests found in section 40.7 of Issue 4 of the standard calls for the device being tested to be disconnected from the AC power line at the moment of the simulated lightning strike and then reconnected to the AC power after the strike is complete.

The prior disconnection of devices is not what would occur in most real-world instances of lightning strikes. During an actual lightning strike, the surge will either be direct or induced onto the AC line where potentially damaging overvoltage will be passed through the Device Under Test (DUT) as it would not be removed from the AC line and reenergized after the surge subsides. In a real-world scenario, a DUT would experience both the AC power and surge simultaneously.

This paper compares this aspect of the UL 1449 discharge current tests with an alternative test that impresses the lightning simulation surge on the AC power line while it remains continuously connected to the device being tested. It also discusses how surge testing live online using different phase angles can affect the test results and the effect of the phase angle on the clamping voltage of the protected component.

# The Effect of Surge Testing Live Online for Surge Protective Devices

## SURGE TEST SET-UP

When testing components and/or devices, the combination wave surge generator (Voltage = 1.2/50  $\mu$ s and Current = 8/20  $\mu$ s) is usually the standard waveform of choice for IEEE, IEC and UL testing as well as for many other recommended standards. While most surge testing requirements are for components without any bias voltage, this paper will also consider the different energy levels with and without bias voltage.

The combination wave, shown in Figure 1, is the standard current waveform. It shows that 90 % of the peak surge occurs at 8  $\mu$ s and it decays to 50 percent of peak at 20  $\mu$ s. Hence, it is called 8/20  $\mu$ s.

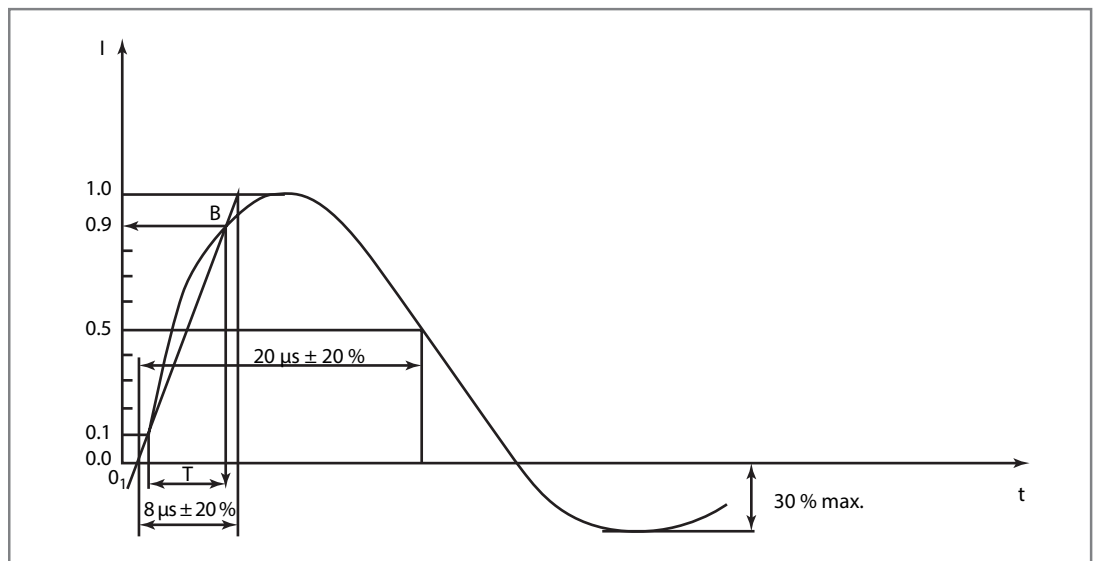

Figure 1 - 8/20  $\mu$ s Waveform

# The Effect of Surge Testing Live Online for Surge Protective Devices

## UL 1449 TESTING

In the United States, UL 1449 is a safety standard and compliance with this standard is a requirement for any Surge Protection Component (SPC) or Surge Protective Device (SPD) to be recognized or listed, respectively. In accordance with UL 1449, the Nominal Current ( $I_{nom}$ ) is tested with three sets of five surges for a total of 15 surges. After each surge, Maximum Continuous Operating Voltage (MCOV) is applied within one second, lasting for about 60 seconds  $\pm$  five seconds. This is repeated until the Device Under Test (DUT) sustains five surges. This series of UL 1449 tests is considered a set. In between each set, there is a 30-minute dwell cooling time. The standard recognizes that the  $I_{nom}$  testing is representative of the life of the component. Meeting the 15 surges represents years of operation in the field.

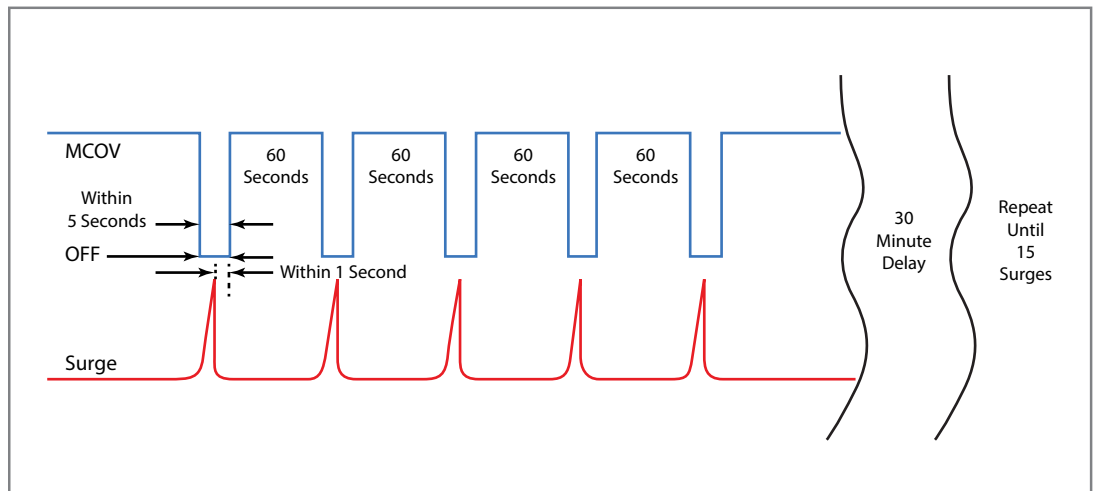

Figure 2 - UL 1449 Nominal Current Testing Diagram

# The Effect of Surge Testing Live Online for Surge Protective Devices

## DEFINING DIFFERENT SURGE TESTS

When a surge is applied with no bias voltage on the line, it is referred to as a “dry surge.” With a dry surge, all current will pass through the component and dissipate within 50  $\mu$ s as seen in the scope screen capture below in Figure 3.

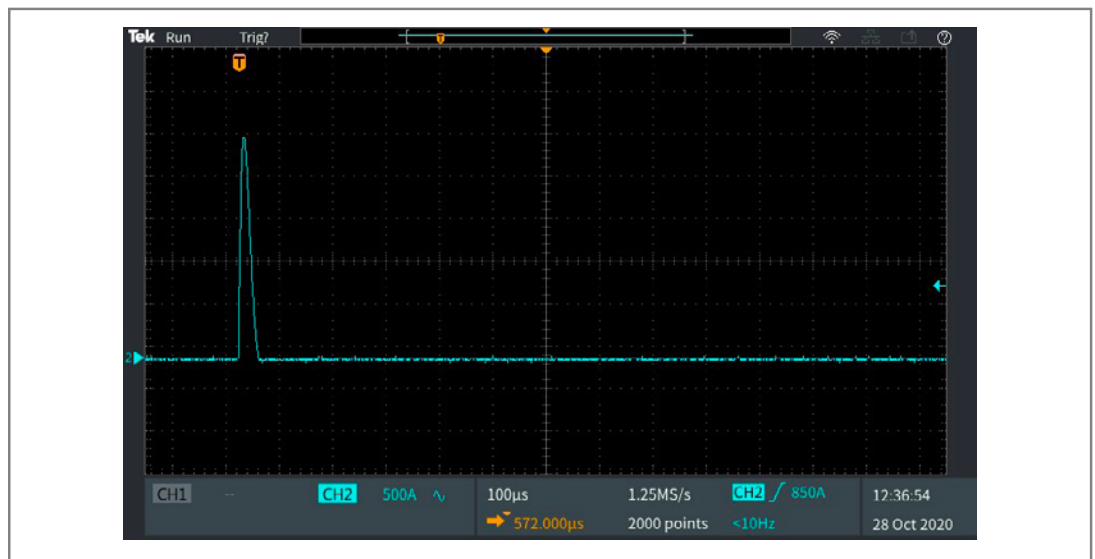

Figure 3 - Current Shown with Dry Surge

In order to superimpose a surge on the AC line, a Coupling / Decoupling Network (CDN) is required. A typical CDN contains a capacitor between L-N, N-E, L-E, and an inductor between the Input and Output. The inductor functions to block surge current from returning to the main AC source. A typical surge generator will have blocking capacitors and/or resistors to prevent AC voltage from interfering with its output (see Figure 4).

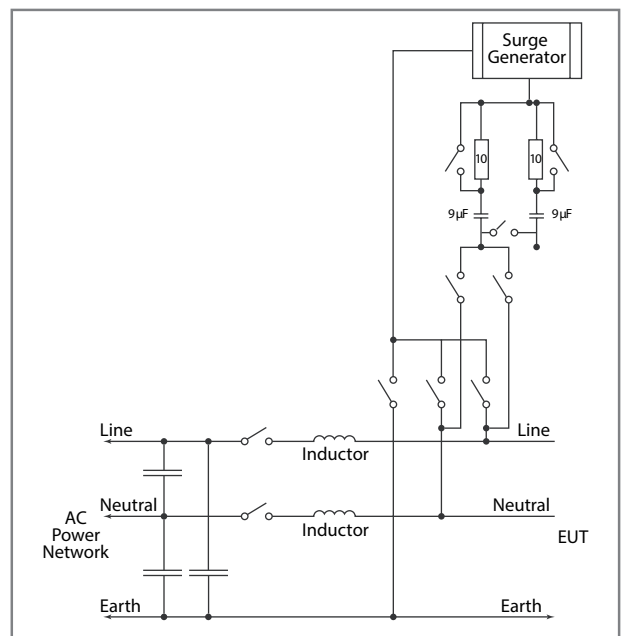

Figure 4 - Current Shown with Dry Surge

# The Effect of Surge Testing Live Online for Surge Protective Devices

## DEFINING DIFFERENT SURGE TESTS (Continued)

When surging at a 90 ° angle, the voltage disruption at the positive peak of the sinewave can be seen in Figure 5 and Figure 6 (Time/Div magnification).

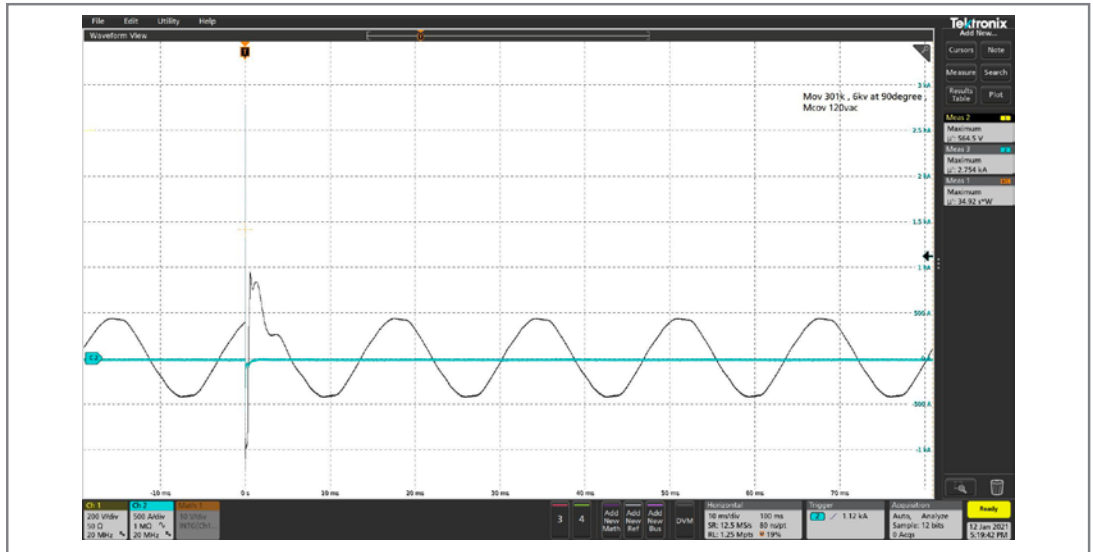

Figure 5

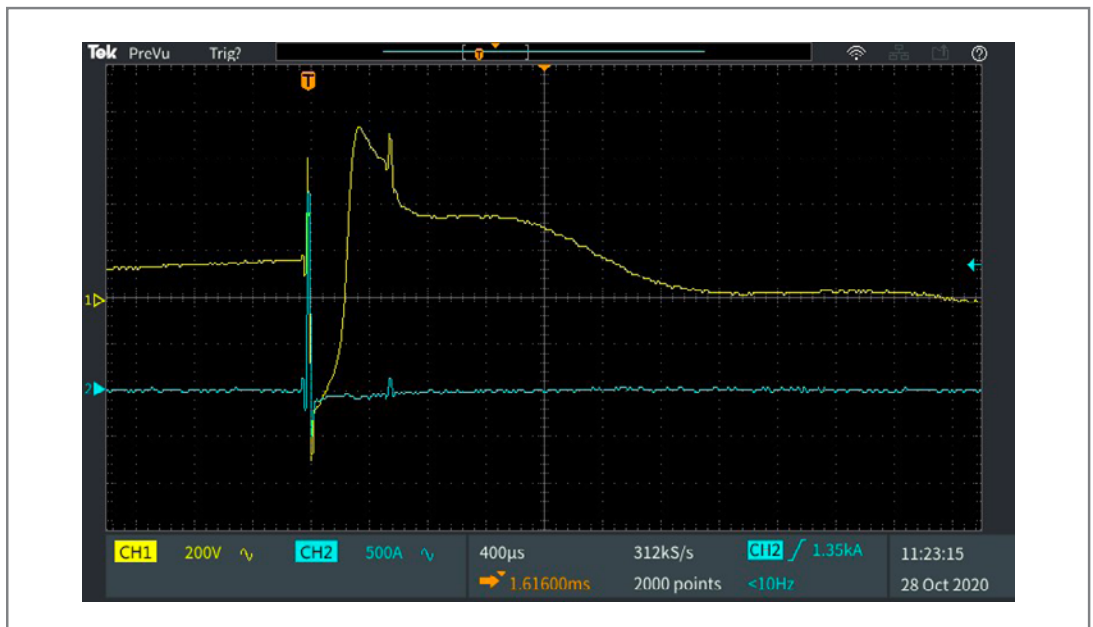

Figure 6 - Surge Live Online at 90 ° angle

# The Effect of Surge Testing Live Online for Surge Protective Devices

## DEFINING DIFFERENT SURGE TESTS (Continued)

In Figure 6, the current (Blue Line) passed through the component and appears flat after the surge dissipated. However, upon magnification (Figure 7) and taking a closer look, there is some residual current (painted red) with peaks up to 400 A lasting more than 60  $\mu$ s and then sustaining some currents for up to 500  $\mu$ s or more.

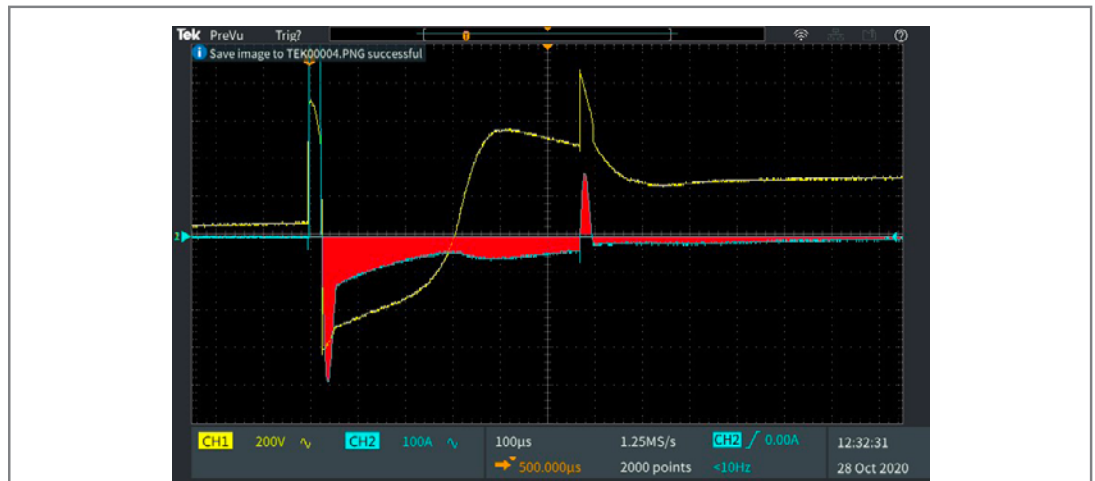

Figure 7 - Highlighted Current Flow after Surge

This prolonged amount of energy, although small relative to the surge current, will continue to flow into the protection device and cause its internal temperature to continue to increase.

Metal Oxide Varistors (MOVs) are bidirectional and non-linear surge suppressor devices that are widely used for limiting voltage during a surge or transient event in a broad variety of applications. Depending on the size and grain structure of the varistor, a surge such as that shown in Figure 7 may increase the temperature enough to break down grain surface and fuse adjacent grains together. As the grains fuse together, the clamping voltage starts to drop. If this drop in clamping voltage continues, the MCOV may eventually drop below the normal operating voltage. In such an event, the varistor typically will be able to sustain current only for several seconds, after which it will enter thermal runaway and a hazard or flame may follow.

On the other hand, in real life transients, the circuit may not contain inductance and/or capacitance, which would likely cause this effect to be more or less severe than what is shown here. Within the Bourns study, the same component lots can typically pass the 15 surges required for compliance with UL 1449 using the dry surge method compared to the live online method. It is important to note that testing in a real-world scenario, such as with surging live online, provides a more representative measure of device performance giving both the engineer and end user more confidence in how the device protects against harmful surges.



# The Effect of Surge Testing Live Online for Surge Protective Devices

## SURGE TESTS WITH DIFFERENT PHASE ANGLES

Does it make a difference to test surging at varying phase angles?

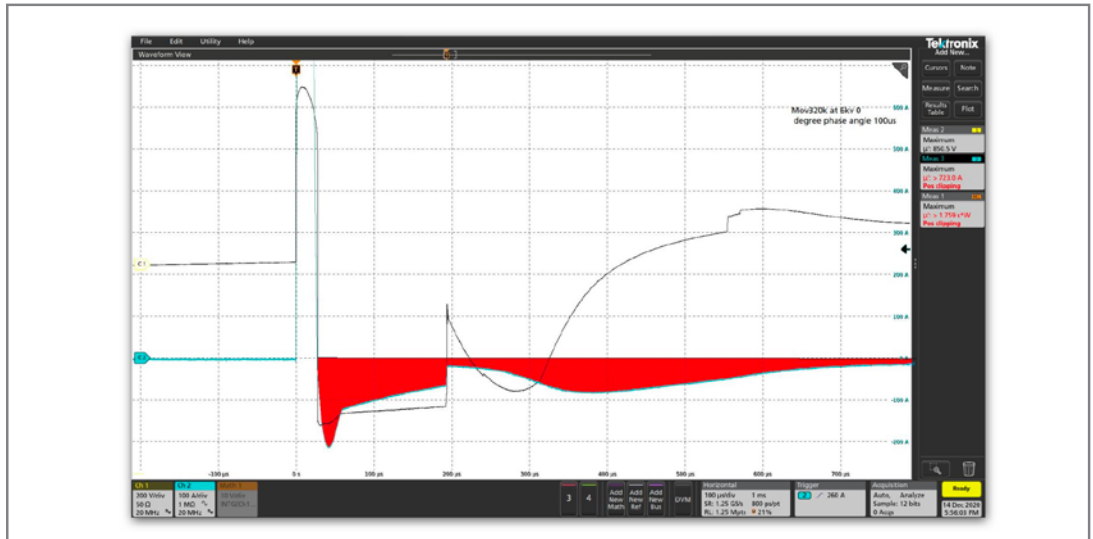

Figure 8 - Scope Image at 0° Angle

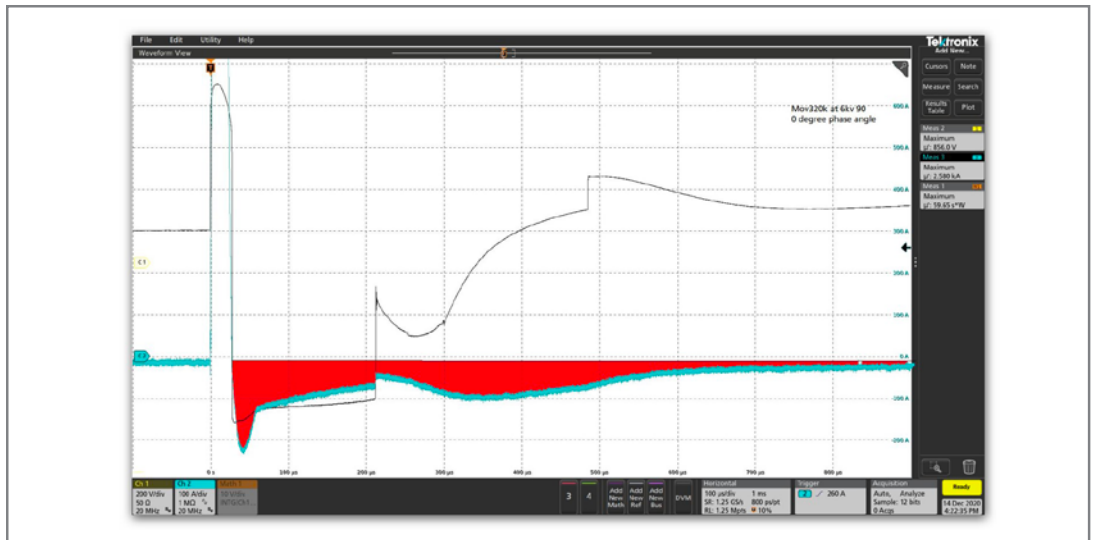

Figure 9 - Image Shot at 90° Angle

# The Effect of Surge Testing Live Online for Surge Protective Devices

## SURGE TESTS WITH DIFFERENT PHASE ANGLES (Continued)

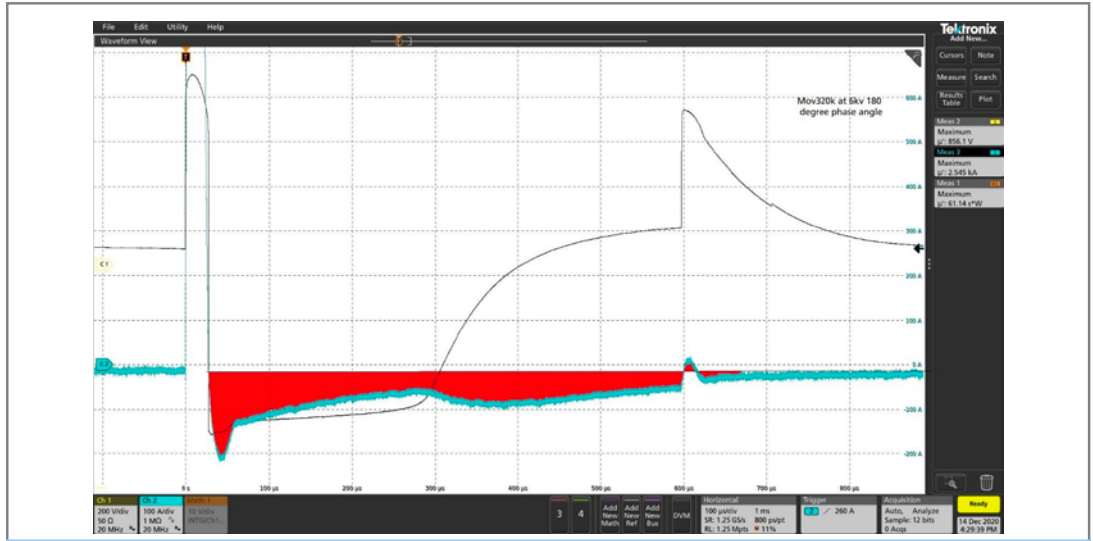

Figure 10 - Scope Image at 180 ° Angle

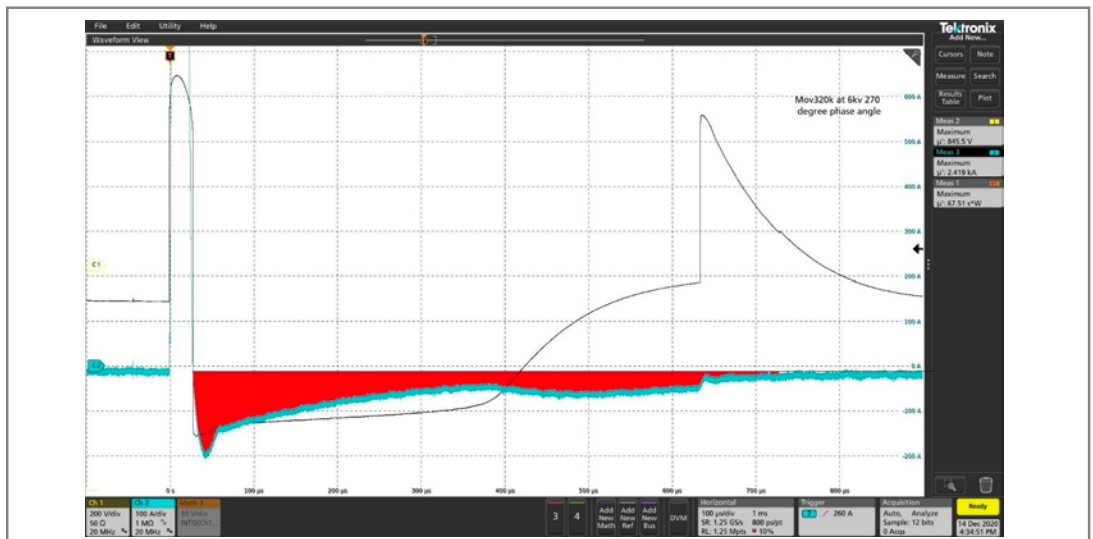

Figure 11 - Scope Image at 270 ° Angle

The tests conducted by Bourns indicate that testing at different phase angles does not appear to have much of an effect on overall results. All angles show the peak clamping voltage to be approximately 850 V and dissipation between 60 to 70 watt second.



# The Effect of Surge Testing Live Online for Surge Protective Devices

## LIVE ONLINE TESTING CONCLUSIONS

In conclusion, surge testing live online does impact the energy through the device since it lasts longer on the negative swing and can create more heat in the protection device. How much of these conditions are due to the inductance and capacitance of the CDN is unknown. However, it is a common practice in the industry to use the CDN in the lab testing environment in order to prevent the surge from damaging the AC power line or sourcing equipment and so as not to disturb the main power of the lab/building. In a real-life scenario directly on the AC line (minus CDN), do we see that same result? This question may need to be studied in the future.

As noted above, testing DUT with dry surges can easily pass the UL 1449  $I_{nom}$  of 15 operations, but live online testing with the CDN could result in a less than desirable outcome. This is due to extra energy that can linger after the surge, as explained above. For compliance, UL 1449 is a standard test setup and the procedure must be followed. However, testing under live online conditions will help engineers to discover any weaknesses or potential issues in their designs. Other Bourns tests also concluded that the phase angle at which the surge is applied appears not to have a significant effect on the clamping voltage, nor the watt second.

[www.bourns.com](http://www.bourns.com)

**BOURNS**<sup>®</sup>

**Americas:** Tel +1-951 781-5500  
Email [americus@bourns.com](mailto:americus@bourns.com)

**EMEA:** Tel +36 88 885 877  
Email [eurocus@bourns.com](mailto:eurocus@bourns.com)

**Asia-Pacific:** Tel +886-2 256 241 17  
Email [asiacus@bourns.com](mailto:asiacus@bourns.com)

COPYRIGHT © 2021 • BOURNS, INC. • 05/21 • e/GDT2116

"Bourns" is a registered trademark of Bourns, Inc. in the U.S. and other countries.