

Medical / Industrial AC-DC Power Supply

1200W with 5V/2A Standby / MEB-1K2A series



Highlights & Features

- Up to 1200 Watt in 5"x8.03"x1.59" Package
- Up to 19.1W/inch³ Power Density
- Full Power from 90V to 264V
- Full Power up to 50° C Ambient
- Up to 500KHrs MTBF
- 2MOOPP Isolation
- Suited for Type BF Medical Products.
- Optional CV/CC Version
- 5V/2A Standby Output
- Current Sharing
- Conformal Coating
- Class B Conducted and Radiated EMI
- IEC60601-1-2 4th Edition Immunity Compliance
- Normal and Reversed Option for Remote On/Off and Power Good Signal
- Analog and Digital Voltage Trimming
- PMBus Ver 1.3 Supported
- Intelligent Fan Speed Control
- Optional RS485 Version

Input	
Input Voltage	85VAC ~ 264VAC
Input Frequency	47Hz ~ 63Hz
Input Current	<15A
Inrush Current	<40A
Power Factor	>0.95 @ rated load
Efficiency	Up to 94% ¹⁾
Patient Leakage Current	<100uA normal, <500uA SFC
Earth Leakage Current	<300uA normal, <1mA SFC
Output	
Output Voltage	24V
Output Current	0-50A
Ripple & Noise	<1% Vrated pk-pk
Standby Power	5V / 2A (No minimum load required)
Environmental	
MTBF	500KHrs
Operation Temperature	-20°C ~70°C ²⁾
Operation Altitude	5000m or 54kPa

1) Exclude fan power

2) Power de-rating with temperature above 50°C, refer to power de-rating curve for detail

Safety Certifications

- IEC60601-1 2nd edition
- IEC60601-1 3rd edition + A1
- CB report
- TUV EN60601-1:2006/A11/A12
- UL60601-1+CAN/CSA 60601-1: (Ed.3.2005)
- IEC60950-1 CB report
- TUV EN60950-1
- UL60950-1+CAN/CSA60950-1
- GB4943.1-2011, GB9254-2008, GB17625.1-2012

Medical / Industrial AC-DC Power Supply

1200W with 5V/2A Standby / MEB-1K2A series

Model Information (With 5V/2A standby available)

Model Number	Input Voltage	Output Voltage	Current Output
MEB-1K2A24T AAA	85-264Vac	24Vdc	0-50A

Model Numbering

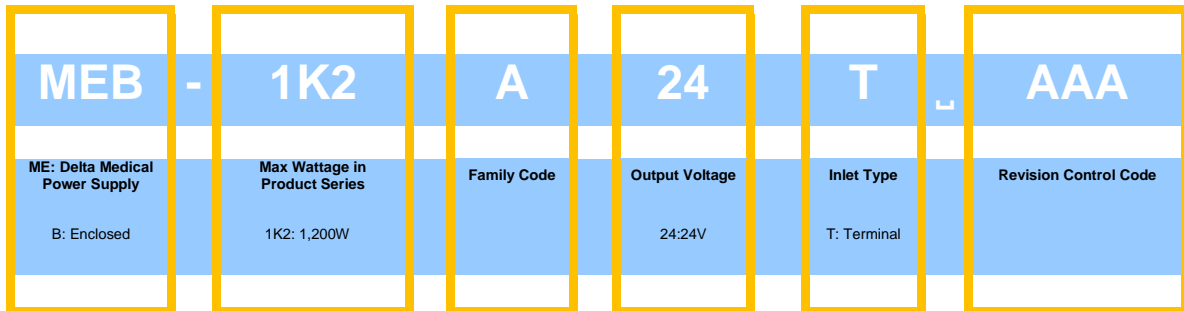

Medical / Industrial AC-DC Power Supply

1200W with 5V/2A Standby / MEB-1K2A series

Specifications

Input Ratings / Characteristics

Nominal Input Voltage	100-240Vac
Input Voltage Range	85-264Vac
Nominal Input Frequency	50-60Hz
Input Frequency Range	47-63Hz
Input Current (max)	15A
Input Surge Voltage (max)	300Vac for 100ms
Full load Efficiency (typ. For 24V output Model)	90% @ 115Vac/60Hz 93% @ 230Vac/50Hz, Reference Fig.1
Inrush Current (max)	40A @ 264Vac, cold/hot start
Input-PE(protective earth) leakage current (max)	0.3mA @ NC, 1mA @ SFC 1)
Output-PE(protective earth) leakage current for Type BF application (max)	0.1mA @ NC, 0.5mA @ SFC 1)
Power Factor (min)	0.95 @ 115V/50Hz, 230V/50Hz, full load

1) NC: normal condition, SFC: single fault condition

Leakage Current

Input-PE Leakage Current	100Vac/60Hz (Typ)	264Vac/60Hz(Typ)	Delta Limit	IEC60601-1 Limit
Normal Condition	92.1	236.6	300uA max	5000uA max
Single Fault Condition	174.3	459.3	1000uA max	10000uA max
Output-PE Leakage Current for Type BF application				
Normal Condition	31.2	79.3	100uA max	100uA max
Single Fault Condition	66.2	169.5	500uA max	500uA max

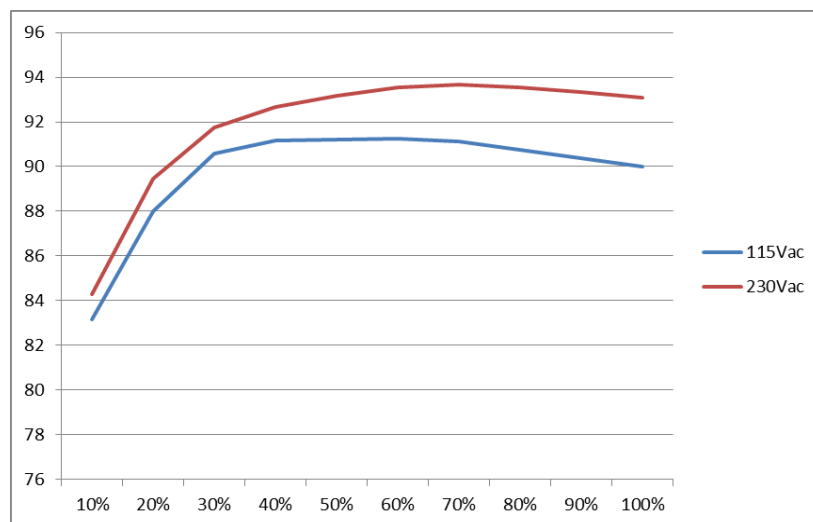

Figure 1 Typical Efficiency Curve for 24V (1200W max)

Medical / Industrial AC-DC Power Supply

1200W with 5V/2A Standby / MEB-1K2A series

Output Ratings / Characteristics

Total Regulation	$\pm 3\%$
Output Power (max)	1200W
Line Regulation (max)	1%
Load Regulation (max)	2%
Ripple & Noise (typ.)	1% pk-pk Vrated@ rated load, Reference Fig. 2
Voltage Trimming Range	$\pm 10\%$ Vrated
Dynamic Response (Overshoot & Undershoot O/P Voltage)	$\pm 5\%$ @ with 50-100% load change
Start-up Time (max)	2000ms with AC turn on
Hold-up Time (min)	16ms @ 1000W load, with nominal input range 20ms @ 800W load, with nominal input range
Capacitive load (max)	6000uF
Rise time (max)	<50ms
Remote Sense	Up to 500mV compensation for voltage drop across external wire connections to load. Short and reverse connection protected.



(a) 115V (measured value=190mV)



(b) 230V(measured value=187mV)

Fig.2 24V output model Ripple & Noise example, 20MHz BW

Nominal Output Voltage of standby output (Vrated)	5V
Nominal Output Current of standby output	2A
Total Regulation of standby output	$\pm 3\%$
Ripple & Noise of standby output	100mV max

Ripple & Noise measurement circuit

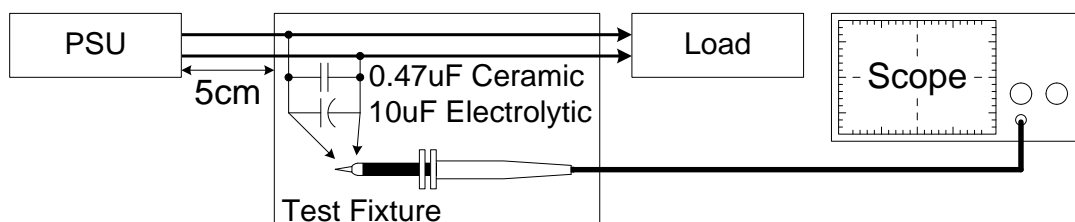

Figure 3 Ripple & Noise testing set up

Medical / Industrial AC-DC Power Supply

1200W with 5V/2A Standby / MEB-1K2A series

Mechanical

Package	Enclosed
Dimensions(W x L x H)	127x204x40.5mm 5x8.03x1.59inch
Unit Weight	1.5kg (3.3lb)

Environment

Surrounding Air Temperature	Operating	Absolute Maximum/Minimum Rating. -20°C to +70°C. Linear power derate from 100% load at 50°C, to 50% load at 70°C Note: see power de-rating curves below
	Storage	-40°C to +85°C
Operating Humidity		5-95% RH (Non-Condensing)
Operating Altitude		Up to 5,000 meters (up to 16,400 feet or 106-54kPa)
Non-Operating Altitude		Up to 5,575 meters (up to 18,290 feet or 106-50kPa)
Shock Test (Non-Operating)		50G, 11ms, 3 shocks for each direction
Vibration (Operating)		5-500Hz, 2Grms, 15 minute for each three axis
Acoustic Noise		<45dB test with 1000W under 30°C ¹⁾

1) Acoustic Noise test set up according to ISO-7779

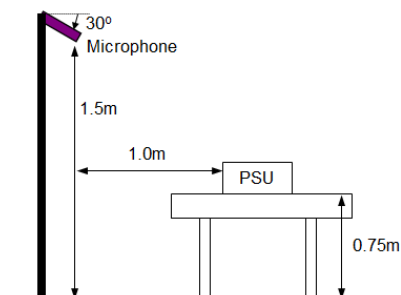

Power De-rating curve

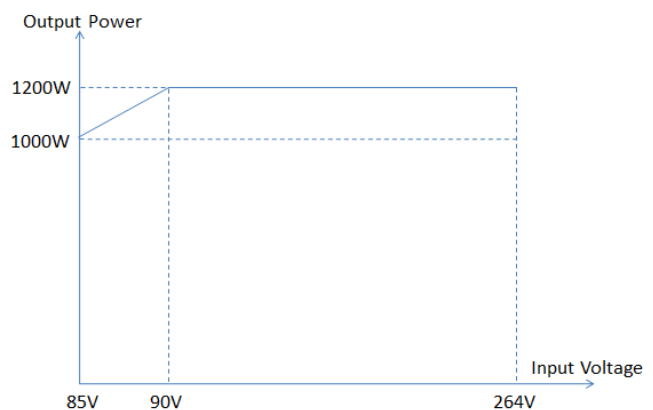
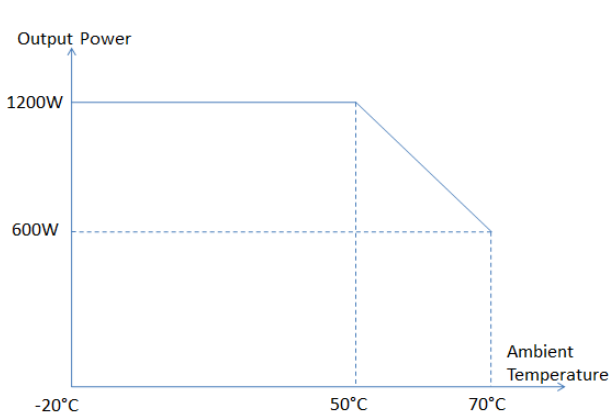

Medical / Industrial AC-DC Power Supply

1200W with 5V/2A Standby / MEB-1K2A series

Protections (for both main output and 5Volt Standby outputs, unless otherwise indicated)

Overvoltage (max)	Main output 145% of rated normal voltage, Latch Mode Standby 125% of rated voltage, Latch Mode
Over load / Over current (max)	Main output 120% of rated current Hiccup Mode(Non-Latching, Auto-Recovery)
Over Temperature	Latch Mode for Main output
Short Circuit	Hiccup Mode (Non-Latching, Auto-Recovery)

Reliability Data

MTBF(Minimum) at 115Vac, 1200W, 35 °C	500 Khrs based on Telecordia SR-332
Operating life(Minimum) at 115Vac, 1200W, 25°C	26,280 hrs

Safety Standards / Directives

Medical Safety	IEC60601-1 2 nd and 3 rd +A1 edition CB report TUV EN60601-1:2006 UL60601-1+CAN/CSA 60601-1: (Ed.3.2005)
ITE Safety	IEC60950-1 CB report TUV EN60950-1 UL60950-1+CAN/CSA60950-1 GB4943.1-2011, GB9254-2008, GB17625.1-2012
CE	MDD Directive 93/42/EEC
Environmental	RoHS Directive 2011/65/EU Compliant
Galvanic Isolation	Input to/Output (2XMOPP) 4000 Vac Input to/Ground(1XMOPP) 1500 Vac Output to/Ground(1XMOPP) 1500 Vac (Type BF application rated)

Medical / Industrial AC-DC Power Supply

1200W with 5V/2A Standby / MEB-1K2A series

EMC

EMC / Emissions		EN55011/EN55032,FCC Title 47:Class B
Harmonic Current Emissions	IEC61000-3-2	Meet Class D limit
Immunity to		
Voltage Flicker	IEC61000-3-3	
Electrostatic Discharge	IEC61000-4-2	Level 4 Criteria A ¹⁾⁵⁾ Air Discharge: 15kV Contact Discharge: 8kV
Radiated Field	IEC61000-4-3	Criteria A ¹⁾ 80MHz-2700MHz, 10V/m AM modulation Level 2 Criteria A ¹⁾⁵⁾ 385MHz-5785MHz, 28V/m Pulse mode and other modulation
Electrical Fast Transient / Burst	IEC61000-4-4	Level 3 Criteria A ¹⁾ :2kV
Surge	IEC61000-4-5	Level 3 Criteria A ¹⁾⁵⁾ Common Mode ³⁾ : 2kV Differential Mode ⁴⁾ : 1kV
Conducted	IEC61000-4-6	Level 2 Criteria A ¹⁾⁵⁾ 150kHz-80MHz, 3Vrms, 6Vrms at ISM bands and Amateur radio bands
Power Frequency Magnetic Fields	IEC61000-4-8	Criteria A ¹⁾⁵⁾ Magnetic field strength 30A/m
Voltage Dips	IEC61000-4-11	30% 10ms Criteria A ¹⁾ 60% 100ms Criteria B ²⁾ 100% 5000ms Criteria B ²⁾
Voltage Dips ⁵⁾	IEC60601-1-2	Criteria A ¹⁾ @1000W 0% U _T , 0.5 cycle(10ms) (0°,45°,90°,135°,180°,225°,270°,315°,360°) Criteria B ²⁾ , can meet Criteria A with 800W or lower load 0% U _T , 1 cycle (20ms), 0° Criteria B ²⁾ 70% U _T , 25 cycle (500ms) , 0° Criteria B ²⁾ 70% U _T , 250 cycle (5000ms) , 0°

1) Criteria A: Normal performance within the specification limits

2) Criteria B: Output out of regulation, or shuts down during test. Automatically restored to normal operation after test.

3) Asymmetrical: Common mode (Line to earth)

4) Symmetrical: Differential mode (Line to line)

5) Compliant with IEC60601-1-2 4th Edition

Medical / Industrial AC-DC Power Supply

1200W with 5V/2A Standby / MEB-1K2A series

Dimensions

Mechanical drawing (MEB-1K2A)

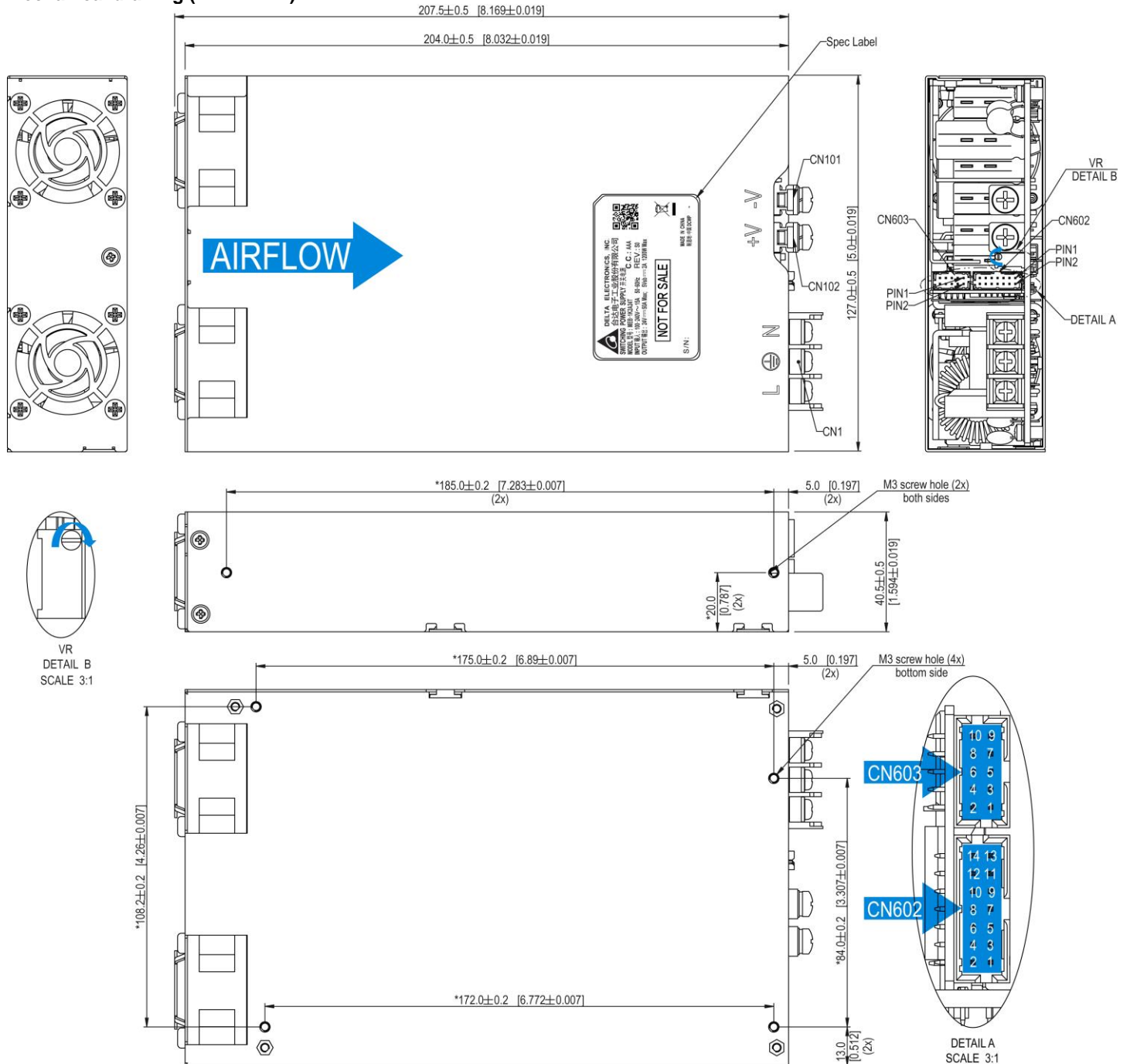

- Notes:**
1. Base plate mounting, M3 thread holes, maximum penetration 4.0mm (0.16 inch) from outside face of chassis, maximum torque 6.3kgf.cm (5.46 inch.lbs).
 2. Side mounting, M3 thread holes, maximum penetration 4.0mm (0.16inch) from outside face of chassis, maximum torque 6.3kgf.cm (5.46 inch.lbs).
 3. CN101/CN102, M5 screw in two positions, maximum torque 20kgf.cm (17.34 inch.lbs).
 4. CN1, M3.5 screw in two positions, maximum torque 12kgf.cm (10.41 inch.lbs).
 5. VR: clockwise is to increase the output voltage, anti-clockwise is to reduce the output voltage.



Medical / Industrial AC-DC Power Supply

1200W with 5V/2A Standby / MEB-1K2A series

Connector Definition and Pin Assignment

Input Connector CN1(ANYTEK: YK50A)	
Pin 1	Neutral
Pin 2	Ground
Pin 3	Line
Output Connector	
CN101	DC RTN
CN102	Vo
Control Connector CN603(Molex:87833-1051) Mating With Molex:51110-1051 Terminal:0503948052	
Pin 1	5V bus for I ² C
Pin 2	DC RTN of 5V bus for I ² C
Pin 3	Serial data signal (SDA)
Pin 4	Serial clock signal (SCL)
Pin 5	NC
Pin 6	NC
Pin 7	Address bit 0 (A0)
Pin 8	Address bit 1 (A1)
Pin 9	Address bit 2 (A2)
Pin 10	NC
Control Connector CN602(Molex:87833-7420) Mating With Molex:51110-1451 Terminal:0503948052	
Pin 1	Remote On_Off/Inhibit +
Pin 2	Remote On_Off/Inhibit -
Pin 3	Power Good-
Pin 4	Power Good+
Pin 5	NC
Pin 6	NC
Pin 7	5V Standby Output +
Pin 8	5V Standby Output +
Pin 9	DC RTN
Pin 10	DC RTN
Pin 11	Remote Sense +
Pin 12	Remote Sense -
Pin 13	Current Share
Pin 14	DC RTN

Medical / Industrial AC-DC Power Supply

1200W with 5V/2A Standby / MEB-1K2A series

Functions

Start-up Time

The time required for the output voltage to reach 90% of its final steady state value, after the input voltage is applied

Rise Time

The time required for the output voltage to change from 10% to 90% of its final steady state value.

Hold-up Time

Time between the collapse of the AC input voltage, and the output falling to 90% of its steady state value

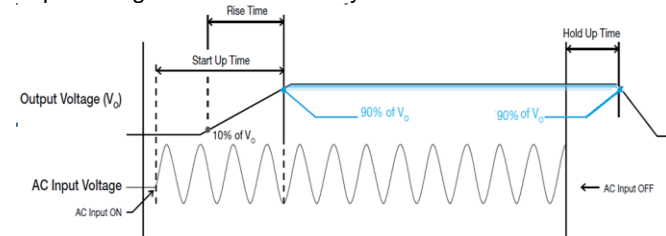

Figure 4 Time sequence

Dynamic Response (Main Output)

The power supply output voltage will remain within $\pm 5\%$ of its steady state value, when subjected to a dynamic load 50 to 100% of its rated current.

■ 50 to 100% Load

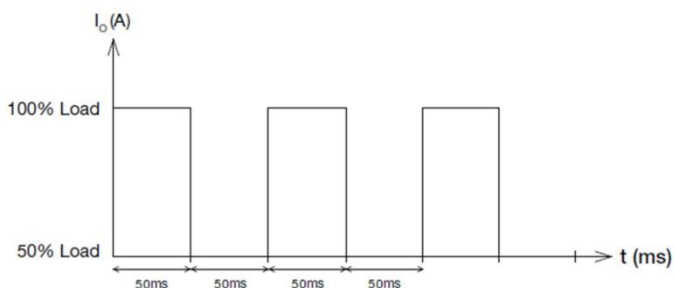

Figure 5 Dynamic Load

Inrush Current

Inrush current is the input current that occurs when the input voltage is first applied. For AC input voltages, the maximum peak value of inrush current will occur during the first half cycle of the applied AC voltage. This peak value decreases exponentially during subsequent cycles of AC voltage.

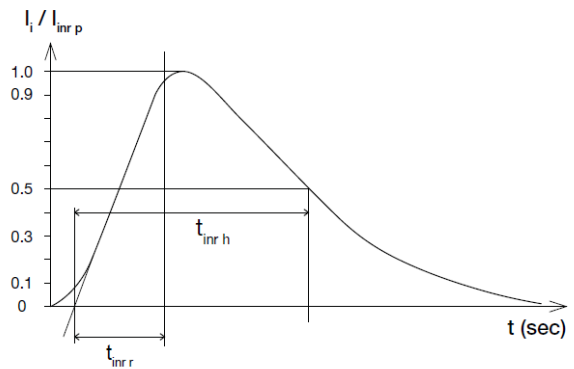

Figure 6 Inrush Current

Overvoltage Protection

The power supply's overvoltage circuit will be activated when its internal feedback circuit fails. The output voltage shall not exceed its specifications defined on Page 5 under "Protections". Power supply will latch off, and require removal/re-application of input AC voltage in order to restart.

Overload & Over current Protections

The power supply's Overload (OLP) and Over current (OCP) Protections will be activated before output current under 160% of I_o (Max load). Upon such occurrence, V_o will start to drop. Once the power supply has reached its maximum power limit, the protection will be activated and the power supply will go into "Hiccup mode" (Auto-Recovery). The power supply will recover once the fault condition causing the OLP and OCP is removed and I_o is back within the specified limit.

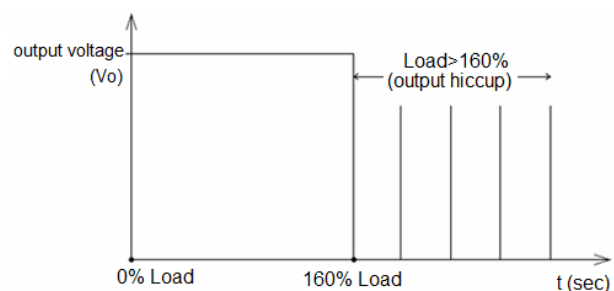

Figure 7 Hiccup at OLP/OCP

Additionally, if the load is $>100\%$; but $<160\%$ for a prolonged period of time (depending on the load), the Over Temperature Protection (OTP) may be activated due to high temperature on critical components. The power supply will then go into latch mode.

Short Circuit Protection

The power supply's output OLP/OCP function also provides protection against short circuits. When a short circuit is applied, the output current will operate in "Hiccup mode", as shown in the illustration in the OLP/OCP section on this page. The power supply will return to normal operation after the short circuit is removed.

Medical / Industrial AC-DC Power Supply

1200W with 5V/2A Standby / MEB-1K2A series

Over Temperature Protection

As mentioned above, the power supply also has Over Temperature Protection (OTP). This is activated when the overload condition persists for an extended duration and the output current is below the overload trigger point but >100% load. In the event of a higher operating temperature condition at 100% load, the power supply will run into OTP when the surrounding air temperature is higher than the operating temperature. When activated, the output voltage will go into latch mode until the input voltage is removed; then, reapplied, and the surrounding air temperature drops to its normal operating temperature.

Power Good

Power Good+/- pin is an isolated open collector transistor (80V/50mA rating). A resistor (suggested value 10Kohm, 1/8W) can be added between Power Good- pin and DC RTN, Power Good+ pin can be connected to 5V standby (or, other available pull-up voltage that is no greater than the transistor rating). Value of resistor may have to be adjusted, depending on voltage used, and other end-use conditions of the Power Good+ pin connection to the product. When AC input is on, Power Good Signal (Shown in below figure) generated will be high. When AC input is off, Power Good Signal generated will be low. There will be a minimum of 5 milliseconds (at 1000W load) between the time the Power Good Signal goes to low level, and the time when the output reaches 90% of its rated value.

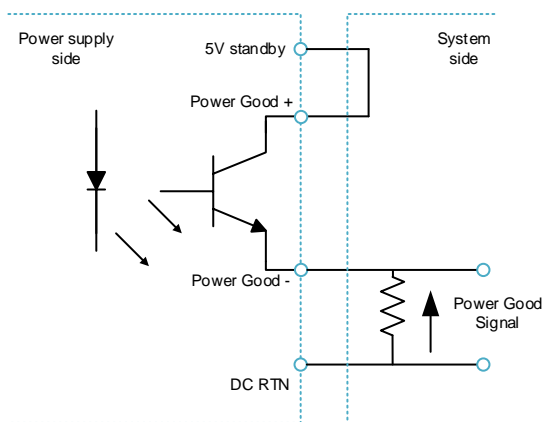

Figure 8 Power Good Connection

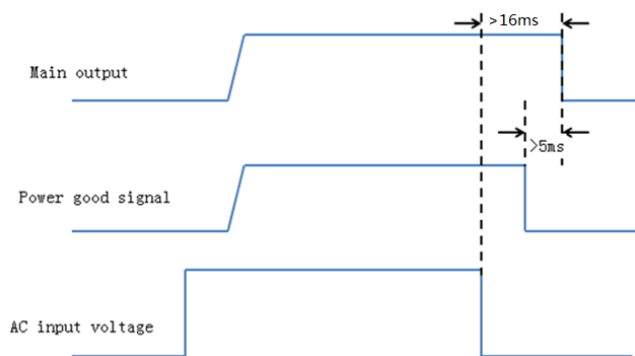

Figure 9 Power Good Time Sequence

Remote On_Off/Inhibit

Remote ON_OFF/INHIBIT uses an isolated diode located within the power supply. This signal can be used to enable or disable only the main output. When the main output is disabled, the +5V Standby output will continue to operate. System can use a switch to conduct through this diode (suggested pull up resistor to 5V standby with 1Kohm resistor) to disable the main out. The signal can be floated (no connection to the signal), in order to enable the main output

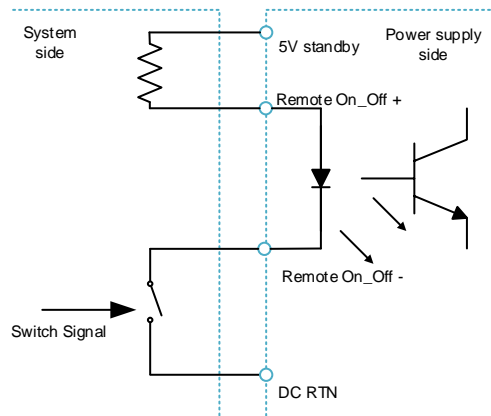

Figure 10 Remote On_Off Connection

Remote Sense

Remote sense feature can be used to compensate for the extra voltage drop on output wires that are connected from the main output terminals, to the load. With wires connected from the remote sense pins, at the same locations as the wires from the main output, the remote sense function can compensate up to 500mV voltage drop. The power supply will not be damaged if the remote sense pins are shorted, or if a reverse/inverted polarity connection is made to the load

Voltage Adjustment

The power supply provides a potentiometer for user to adjust the output voltage. The output voltage is designed to be able to adjust up to $\pm 10\%$ of rated voltage, when the output is adjusted below nominal value, the maximum output current is the same as the nominal output, when the output is adjusted above nominal value, the output power cannot exceed the nominal maximum power (the maximum output current will be reduced accordingly).

PMBus

The power supply can communicate with the host product, using PMBus version 1.3 protocols. Multiple functions can be realized, such as monitoring the power supply operation status, and editing the power supply operating set-points. See user instruction for detailed control information.

Current Sharing

The power supply supports current sharing. Parallel the outputs as well as the current sharing bus to enable this feature.

Medical / Industrial AC-DC Power Supply

1200W with 5V/2A Standby / MEB-1K2A series

Certificate



All Delta Medical Power products conform to the European directive 2011/65/EU.

ROHS is the abbreviation for “Restriction of the use of certain hazardous substances



Delta has been certified as meeting the requirement of ISO 13485: 2003 and EN ISO 13485:2012 for the design and manufacture of switching power supply and adaptor for medical device.



In addition to a UL Total Certification Program (TCP) approved client laboratory for IEC60950 and IEC60065. Delta also has participated UL Client Test Data Program (CDTP) for IEC 60601