

# focus

Edition 38

## Intelligent buildings: enabling a smart, sustainable future

**4** The evolution of connectivity for building automation

**10** The growing role of sensors in modern building management systems

**18** From AC to DC: powering intelligent buildings

Focus is the quarterly magazine from Avnet Abacus, featuring in-depth trend and technology reviews, new product spotlights, Avnet community news and interviews with market leaders.

Avnet Abacus is a pan-European distributor committed to supporting customers from design to fulfilment. Our exceptional linecard features globally recognised manufacturers and an extensive product range that includes interconnect, passive, electromechanical, power supply, energy storage, wireless & sensor products and solutions.

## Features

- The evolution of connectivity for building automation **4**
- The growing role of sensors in modern building management systems **10**
- From AC to DC: powering intelligent buildings **18**

## Supplier technologies

### Connectors

- Hirose FH40 series connectors **9**

### Power

- Better, greener, smarter buildings with Molex **23**

### Sensors

- Murata presence and motion detection solutions **15**
- OMRON B3S sealed tactile switches/D6T-32L MEMS thermal sensor **16**
- Bourns intelligent building solutions **17**

If you have any comments or questions on the technologies featured in this edition, or wish to speak to one of our technical specialists, you can get in touch at [avnet-abacus.eu/ask-an-expert](http://avnet-abacus.eu/ask-an-expert)

**Editor** Anais Dupont  
**Design** Chiltern Graphics  
**Print** Image Evolution

Keep up to date with the latest news, product information and technical insights via our social media channels.



Welcome to this edition of Focus magazine, which looks at the way in which the places where we live, work and play are becoming smarter, and what it takes to make them so.

Why do we care? Because, according to a widely cited US study from 2001, many of us spend around nine tenths of our lives indoors. If to be human now means to be indoors, developers and OEMs need to ensure that the buildings in which we spend so much time are healthy, comfortable and secure.

In the last couple of decades the rate of progress in building intelligence has accelerated rapidly. The availability of low-cost embedded computing has enabled developers to distribute intelligence throughout buildings to sense and manage their state. Historically, these systems focused on managing environmental services such as heating, ventilation and air conditioning. More recent building-management systems include functions that improve the effectiveness of lighting, monitor air quality, and enhance security. Today, developers are also expected to ensure that buildings are smart enough to take an active role in mitigating their climate impact.

In this edition, we look at three key enablers of smart buildings: sensing, connectivity and power distribution. In each case, given the relatively long lifecycle of the building industry's products, change is more likely to be evolutionary than revolutionary. But wise developers, and the OEMs that provide the equipment and services, will keep an eye on this evolution to ensure they can anticipate what their clients will need next.

Our feature on sensing in smart buildings looks at innovations in how basic building parameters, such as temperature, humidity, water and air quality, are sensed. It discusses how these basic measurements can be combined in sophisticated ways to infer other building parameters, such as occupancy. And it looks at some new ways in which buildings are deploying sensors, especially for health monitoring.

Sensors are useless if they cannot transmit their data to where it can be analysed and acted upon. Our second feature focuses on the evolution of the building connectivity schemes which provide that vital link. We find that although the idea of moving to an all-IP approach is attractive, developers are more likely to have to manage the coexistence of multiple connectivity schemes for some time yet.

Our third feature looks at power distribution and explores a trend to implement DC power buses in buildings. These buses, running at 24VDC and 385VDC, would directly power equipment that would otherwise rectify a 240V AC input to the DC they need. Making this change can offer energy efficiency gains, at the cost of a substantial rethink about wiring schemes, safety and ground protection.

Given we spend so much time indoors, we need smart buildings to keep getting smarter. We hope this edition of Focus helps designers think about how that can be achieved.

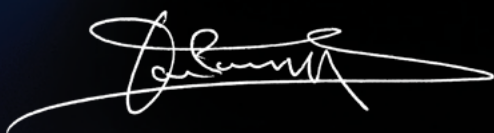

Rudy Van Parijs  
President, Avnet Abacus

# Smart focus

# The evolution of connectivity for building automation

**'The traditional heating, ventilation and air-conditioning (HVAC) controllers that have been in use for decades are giving way to more sophisticated technology, enabled by a rich set of connectivity options that act like a building's central nervous system.'**

**Buildings are evolving rapidly as developers try to maximise their returns, users' expectations change, and climate-change mitigation becomes urgent. Building automation systems are being updated to address these concerns.**

The traditional heating, ventilation and air-conditioning (HVAC) controllers that have been in use for decades are giving way to more sophisticated technology, enabled by a rich set of connectivity options that act like a building's central nervous system. While taking a clean-slate approach to implementing these nervous systems has its attractions, many developers are minimising their risk by integrating multiple connectivity options and communications protocols to create heterogeneous smart building systems from tried-and-tested subsystems.

## **Changing expectations of buildings**

Why the shift to intelligent buildings? The large capital investments involved in a new-build project mean that the resultant space must work as hard as possible during its operating lifetime to maximise profitability. With the rapidly changing nature of work, leisure, manufacturing, logistics, retail and care, buildings must be able to adapt to new circumstances. Co-working company WeWork demonstrated the principle by adapting legacy city-centre buildings into flexible office space. Now the pandemic has taught us that, in extremis, exhibition complexes can become hospitals, gyms can become vaccination centres, and our homes can become our workplaces.

New buildings must be designed to ensure that their physical space can be easily and cost-effectively adapted. They must also have a flexible smart building

## Martin Keenan

Director of Technical  
Development,  
Avnet Abacus



infrastructure that can be quickly reconfigured to deliver the necessary power, lighting, HVAC, IT, and data networks to wherever they are needed, however the building is configured.

Buildings also need to be rethought to minimise their climate footprints. Some of this can be achieved through stricter building codes, innovative materials, and new approaches: for example, employing wireless connectivity instead of structured cabling, to save raw materials such as copper. Intelligent building strategies can also mitigate one of the largest climate impacts of buildings: the way they are used. For example, combining presence detection with room-by-room HVAC and lighting control can stop office space being heated, cooled, or lit when it is unoccupied.

Smart buildings are also being equipped with comprehensive surveillance and security measures, to protect them against a variety of threats. These measures can include IP-based security cameras, presence detectors and, since the pandemic, thermal imaging at building entries to recognise people with elevated temperatures. Footfall-counting systems, enabled by infrared sensors, are also being introduced to track how many people are in a room at once.

These advances in technical infrastructure can help smart building-management systems adjust HVAC settings to match occupancy levels. They can also provide the raw data needed to understand the dynamics of a building's occupancy – useful, for example, for tracking consumer trends in retail spaces or optimising the deployment of staff in many other contexts.

## The evolution of connectivity for building automation

The pandemic has also taught us that buildings can have an important impact on our health. HVAC systems are being upgraded so that they can monitor and improve air quality, using sensors to detect heat and humidity, as well as the concentration of key gases such as oxygen, nitrogen, and carbon dioxide.

Lighting is another critical aspect of intelligent building strategies. Properly designed lighting can encourage consumers to buy more in shops, enable office workers to concentrate for longer at their desks, and help people enjoy their time in social spaces. One way to deliver such highly functional lighting is through intelligent lighting systems, which can be remotely controlled to deliver a variety of effects and to adapt quickly to greater changes such as the reconfiguration of building spaces.

There are at least two approaches to implementing such intelligent lighting grids: one gives the lights standalone power and then connects them to the building management system over a Bluetooth mesh; the other uses Power-over-Ethernet to provide both energy and control data to each light.

In another example of how interwoven the choice of connectivity strategies is becoming with the operation of buildings, some developers are considering using intelligent lighting to provide data links as well as functional lighting.

Li-Fi, enabled by modulating the lighting LEDs at high enough frequencies to carry valuable amounts of data without causing perceptible flicker, is regarded by some as an alternative to Wi-Fi. Some also claim that Li-Fi is more secure than Wi-Fi in some use cases.

### Wired connectivity standards

Because intelligent buildings are expected to integrate so many different types of functionality, they often use heterogeneous connectivity strategies carried forward from other disciplines. Many traditional building-management systems use hierarchical connectivity, with a primary bus connecting high-level building controllers to each other, and then secondary buses providing connections to lower-level controllers, I/O devices, and user interfaces.

Devices talk to each other over open protocols such as BACnet or LonTalk, and physical connectivity is provided in various ways, including optical fibre, Fieldbus or traditional Ethernet links, RS232 and RS485 serial connections, or specialised low-power, low-bandwidth wireless networks.

Advanced building management systems are moving towards using IP as a unifying protocol for all communications. Connectivity is then provided in a variety of ways, including fibre for building backbones, traditional Ethernet with power-over-Ethernet options,

'Advanced building management systems are moving towards using IP as a unifying protocol for all communications.'



and wireless options including Wi-Fi, Li-Fi, Bluetooth, Zigbee and even 5G.

One emerging connectivity option is Single Pair Ethernet (SPE), a cut-down version of traditional Ethernet that uses a single twisted-pair for data transmission and features miniaturised connectors. SPE offers a dense, fast, quick-to-install and lower cost wired connectivity option than traditional Ethernet. SPE is defined in the IEEE standard 802.3cg-2019 amendment and specifies 10Mbit/s transmission over distances of up to 1,000m (10Base-T1L). Signals to this standard will need conversion to connect to 10/100/1000Base-T networks.

The SPE standard is supported with emerging SPE cable, connector, and channel-performance specifications. The new SPE connector, defined in IEC 63171-1, looks like the LC connector used for optical fibres and so is known as a 'copper LC'. It will also be possible to deliver up to 50W over SPE, although the approach used is not compatible with current power-over-Ethernet infrastructure. Work is also underway to define how SPE should be used in structured cabling installations, enabling it to play a larger role in intelligent building infrastructure in the future.

### Wireless connectivity

Many different protocols are being pressed into services to enable wireless connectivity in intelligent buildings. For example, the mesh-networking capabilities of Bluetooth LE make it easy to create ad hoc wireless networks among low-cost sensors installed in a smart building. Bluetooth's beacon capabilities can also be used to provide building occupants with highly localised data services.

Multiple low-power wireless LAN technologies, such as Zigbee, can also be used to enable smart building functionality. As with wired connectivity, although it would be tidy to stick to a single standard, in practice intelligent buildings will probably have to implement multiple low-power WAN standards to support the use of a wide variety of functions such as sensors, lighting, and local controls.

One key standard for wireless connectivity within intelligent buildings will be IEEE802.11ax, commonly known as Wi-Fi 6. This uses the same frequencies and channel structure as previous Wi-Fi standards, but more sophisticated modulation schemes to enable higher data-rates over the same amount of radio spectrum. Wi-Fi 6 employs a multipath technique known as multi-user multiple-input multiple-output to enable each access point to handle eight simultaneous users, twice as many as supported by Wi-Fi 5. And beam-forming techniques will extend the reach of each router. Support for a technique called 'target wake time' will enable Wi-Fi 6 routers to tell devices when to wake and when to sleep, so that they can minimise their power consumption. As a side effect, having fewer devices polling the router will reduce radio interference, increasing its aggregate throughput.

This combination of features will make it easier for intelligent building designers to deliver high-bandwidth connectivity to transient populations of multiple users in busy locations from fewer routers. It will also make wireless connectivity a more capable connectivity option for semi-permanent infrastructure such as security cameras.

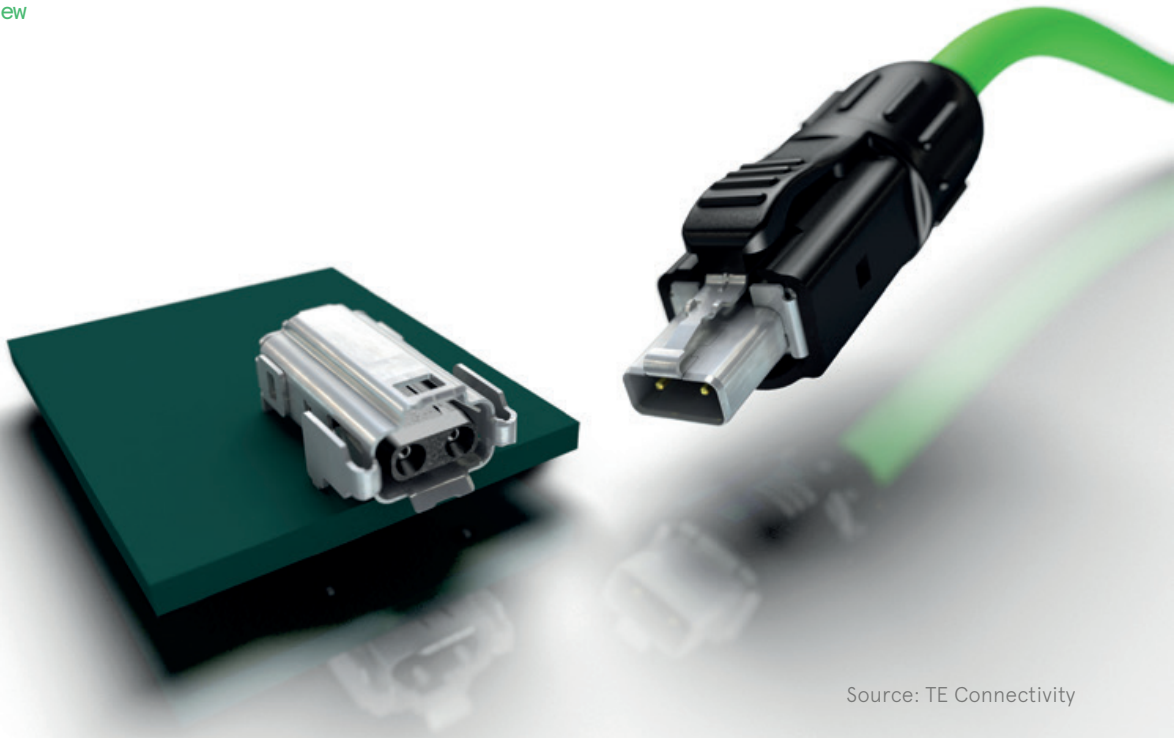

Source: TE Connectivity

At the top of the wireless connectivity stack, in terms of capability and complexity, is the 5G cellular standard. This broadly drawn mobile communications standard offers higher bandwidth, lower latency and support for more devices per unit area served than previous cellular standards. The standard also includes two low-energy, low-datarate communications protocols that are formulated to support Internet of Things devices. The promise in 5G is that many intelligent building connectivity needs could, in theory, use equipment operating to a single umbrella standard.

Implementing 5G in buildings will involve the installation of multiple 5G signal repeaters, or a distributed antenna system that connects back to a centralised 5G basestation. Users will also have to decide whether they want to implement a private 5G network, or simply bring an external carrier's network indoors. Propagation issues, especially with the millimetre-wave bands licensed for 5G in places such as the US, will also make it important to do proper radio planning to minimise interference among co-located wireless networks while maximising service to each user.

### Conclusion

The premise of intelligent buildings is that, with the right communications, sensing and actuation infrastructure, buildings will evolve from being useful places for keeping out of the weather to sophisticated 'machines for living'. This idealised vision would, of course, be enabled by leading-edge technology throughout and a single, heterogenous connectivity backbone.

In reality, today's intelligent buildings have evolved from yesterday's not-so-intelligent buildings, and so their functionality and connectivity will be implemented with a mix of existing and new technologies. Connectivity planning in this context, therefore, will be much more about ensuring peaceful coexistence between multiple standards than it will be about choosing the right clean-slate approach to work with.



FH40 series, 0.5mm mating pitch, robust, vertical mount, FPC connector from Hirose

Hirose

Hirose has an established reputation in the industry for the production of innovative, high quality connectors. Recognising the demand for robust, vertical, FPC connectors, Hirose has introduced the FH40 series.

The housing incorporates a robust locking structure, which is supported by the utilisation of unique contacts that form a reliable hinge point for the rotating actuator instead of relying on the housing walls. This means that the actuator is fully supported along the whole length of the connector and guarantees superior performance and reliable connection.

The actuator has been innovatively designed to incorporate a pressurised surface angle to prevent accidental lock release caused by vibration. The actuator has a strong and thick construction to withstand against rough operation and allows a high FPC retention force of 26N (Newton's) minimum.

Special cavities on each side of the connector are known as 'side catchers'. These are provided to hold a tabbed FPC in place, this allows a temporary holding facility for easy and accurate guided positioning. The insertion of the FPC is very smooth due to the wide guide area on the connector.

A standard, 0.3mm thick tabbed FPC can be used, which is the same for the popular FH28 series, right angle version, allowing flexible design choice.

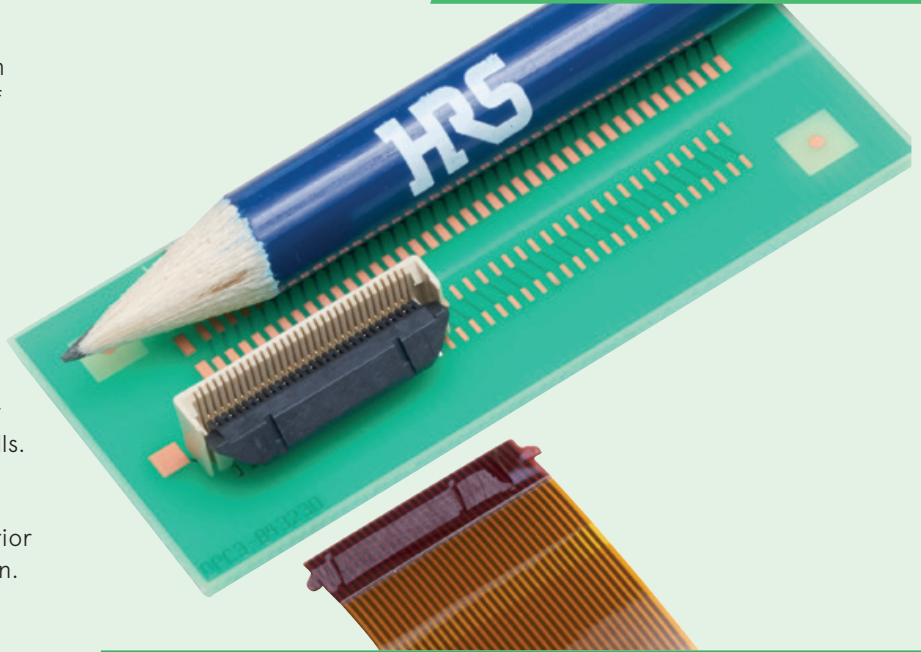

#### FEATURES

- Contact positions: 10, 20, 24, 30, 40, 45, 50, 60, 64, 80
- Height: 5.8mm
- Pitch: 0.5mm
- Current rating: 0.5A
- Voltage rating: 50V
- Robust structure
- Mating cycles: 20
- Operating temperature: -40°C to +105°C

For more information visit [avnet-abacus.eu/hirose](http://avnet-abacus.eu/hirose)

**HRS**® HIROSE  
ELECTRIC  
EUROPE B.V.

# Build reliable, efficient smart city equipment

Learn from TE connectivity's experts.

**AVNET**®  
ABACUS

REGISTER ON DEMAND AT:  
[avnet-abacus.eu/te-smart-city-masterclass](http://avnet-abacus.eu/te-smart-city-masterclass)

**TE**  
connectivity

AUTHORIZED DISTRIBUTOR



# The growing role of sensors in modern building management systems

**'Sensing for intelligent buildings involves measuring both basic parameters and combining multiple sensing signals to determine other parameters, such as building occupancy.'**

## Alessandro Mastellari

Technical Specialist Wireless  
& Sensors  
Avnet Abacus



**Buildings are getting smarter in response to growing user expectations, developers' desire for greater profitability, and the availability of enabling technologies. The heating, ventilation and air-conditioning (HVAC), security and lighting systems of the past are being updated and augmented by new services designed to make buildings more comfortable, efficient, climate-friendly and profitable.**

The key enabler of intelligent buildings is sensing technology that provides the raw data upon which these services rely. The relatively low cost of deploying many sensor types is also encouraging developers to deploy them specifically to enable analytic techniques that can create entirely new insights about the way that their buildings are used. It is these new applications that will make buildings truly intelligent.

### Simple sensing

Sensing for intelligent buildings involves measuring both basic parameters, such as temperature or humidity, and combining multiple sensing signals to determine other parameters, such as building occupancy.

For example, simple contact sensors can be used to show whether doors and windows are open or closed. The resultant data forms a useful basis for general building security. But the low cost of contact sensors also enables them to be widely deployed, bringing additional security benefits when, for example, used in places such as laboratories to track access to restricted store cupboards, cabinets, or fridges.

Thermal sensors have long been used in HVAC systems to measure ambient air temperatures and are now also being used to check the operating temperature of sensitive equipment, such as on-premises data centres, to ensure it can work as efficiently as possible. Continuous temperature monitoring also plays an important role in ensuring that HVAC systems do not harbour dangerous bacteria such as legionella.

Temperature-sensing technologies include the old-fashioned thermocouple, temperature-dependent resistors, negative thermal coefficient thermistors, and semiconductor devices.

## The growing role of sensors in modern building management systems

Humidity sensors measure the amount of water vapour in the air, and are important for keeping people comfortable, ensuring machinery can operate correctly, and for preserving health by avoiding the growth of mould and spores in buildings. Humidity detection can be done by capacitive, resistive, or thermal means.

Water-quality sensors are used to measure chemicals, ions, suspended solids, organic elements, and pH levels, and so are important for ensuring that a building's potable water is fit for human consumption, suitable for use in any onsite machinery, and, critically, can be used in air-conditioning systems without causing health issues. Pressure or flow sensors can also be deployed to monitor, for example, whether filter screens are becoming clogged and need maintenance.

**'Motion sensing is becoming increasingly important in intelligent buildings, for security and surveillance purposes, and to ensure that buildings don't waste energy by heating and lighting empty rooms.'**

The pandemic has prompted increasing interest in the quality of the air that we breathe. Common gas sensors can measure oxygen concentrations in room air, carbon monoxide as part of fire-sensing systems, and carbon-dioxide levels to avoid stuffiness in highly insulated buildings. Smoke sensors can measure the level of air-borne particulates, essential for fire safety. And pollen sensors are being developed that can detect, identify, and count pollen, mould, dust, and other particles, such as silicates and microplastics, in real time.

Data from these sensors can be integrated with temperature and humidity readings as part of environmental monitoring schemes in buildings.

### Motion sensing

Motion sensing is becoming increasingly important in intelligent buildings, for security and surveillance purposes, and to ensure that buildings don't waste energy by heating and lighting empty rooms. There are several forms of motion sensor. One of the simplest is based on flooding an area with ultrasonic waves. The sensor then measures the way those waves are reflected within the environment, and how they are altered by the presence of a person. Passive infrared sensors (PIR) detect the heat people emit by comparing the differing amounts of infrared radiation arriving at two windows in front of the active element of the sensor. When people are static, the amount of radiation arriving at the two windows is the same. When they move, the amount of infrared arriving at each window differs, indicating movement.

These simple sensors have been widely used in domestic burglar alarms, automatic doors, and no-touch hand dryers for years. However, they are now being used to much more sophisticated effect. For example, a simple PIR detector can be mounted under a desk or table, or above a cubicle, to sense whether anyone is occupying that space. Small sensor windows and narrow lenses help the sensors avoid false positives, for example from people walking past a desk. Sensors are mounted in a small battery-powered box, with a low-power wireless connection to a gateway linked to the building management system.

It is also possible to use infrared to check how far people are from a sensor, by measuring how long it takes for an infrared pulse to be reflected off a person and return to the sensor. An infrared sensor array can go one step further, measuring the direction in which people are moving as well.

### Other sensor types

Some intelligent building developers are installing electric current sensors so they can monitor the way that electricity is used in their properties. It seems like a crude approach, but the correct deployment of current sensors (on individual machines, circuits, or zones) can provide data for managing energy efficiency in a building as well as helping to monitor the operation of critical equipment. Once such sensors are in place, it becomes possible to build up a historic profile of normal current consumption for each machine, circuit, or zone, and therefore to automatically recognise anomalies and take action to investigate and rectify them. Some sheltered housing developers are even piloting schemes that track electricity usage in their

facilities, so that concerned relatives can keep an eye on whether residents are maintaining their daily routines (boiling a kettle in the morning, making toast at lunchtime) to help monitor their welfare.

Intelligent buildings may use other forms of sensor, including optical sensors for monitoring light, and level sensors to check how much fluid is in reservoirs to sense possible overflows. Parking garages may use specialised gas sensors to check for the build-up of exhaust gases or any fuel spillages in basements. And very tall buildings are increasingly using accelerometers as part of active vibration-damping systems designed to counter the effects of high winds and minor seismic events.

**'Some intelligent building developers are installing electric current sensors so they can monitor the way that electricity is used in their properties.'**



## The growing role of sensors in modern building management systems

### Putting sensor data to work

Each of these sensors is fairly simple but the data they generate can be very powerful when aggregated for analysis within the context of a building management system. This level of data gathering also has privacy implications. For example, a positive application of occupancy monitoring sensors would be to efficiently allocate spaces in a hot-desking environment, but the technology could also be abused by overzealous employers to check on staff presence. Similarly, time-of-flight sensors can be used to monitor the flow of people through a building, which is useful for ensuring safety and security, but abusive if used to track consumer shopping patterns in a supermarket.

Legislation such as Europe's General Data Protection Regulation must be considered when planning the services that will be derived from sensor deployments in intelligent buildings.

It is increasingly important that the buildings in which we live, work and play protect our health and the health of the planet by providing maximum comfort at minimal environmental cost. A wide variety of sensors is now available to provide the raw data necessary to make this kind of multifactor optimisation possible. These large sensor deployments can also enable new kinds of analysis which, when used responsibly, will make intelligent buildings even smarter.



'It is increasingly important that the buildings in which we live, work and play protect our health and the health of the planet by providing maximum comfort at minimal environmental cost.'



## Presence and motion detection solutions from Murata

Murata

Connected technology is changing the way we live. IoT solutions enable us to connect and automate building, technology, and energy systems, transforming the way our facilities are managed. Murata's PIR sensor and Ultrasonic sensor contribute to presence and motion detection systems that can bring more productive and efficient way of life.

### IRA SERIES PIR SENSOR

#### FEATURES

- Delivers high sensitivity and reliable performance
- Excellent S/N ratio
- High stability against ambient temperature changes
- Excellent immunity to electromagnetic waves

### ULTRASONIC SENSOR

#### FEATURES

- Ultrasonic sound transmitter and receive detects objects and measures distance
- High sensitivity and SPL- SMD version also available

#### APPLICATIONS

- Home security
- Presence detection at home (smart home)
- Wakeup function for control panel
- Energy saving/smart light

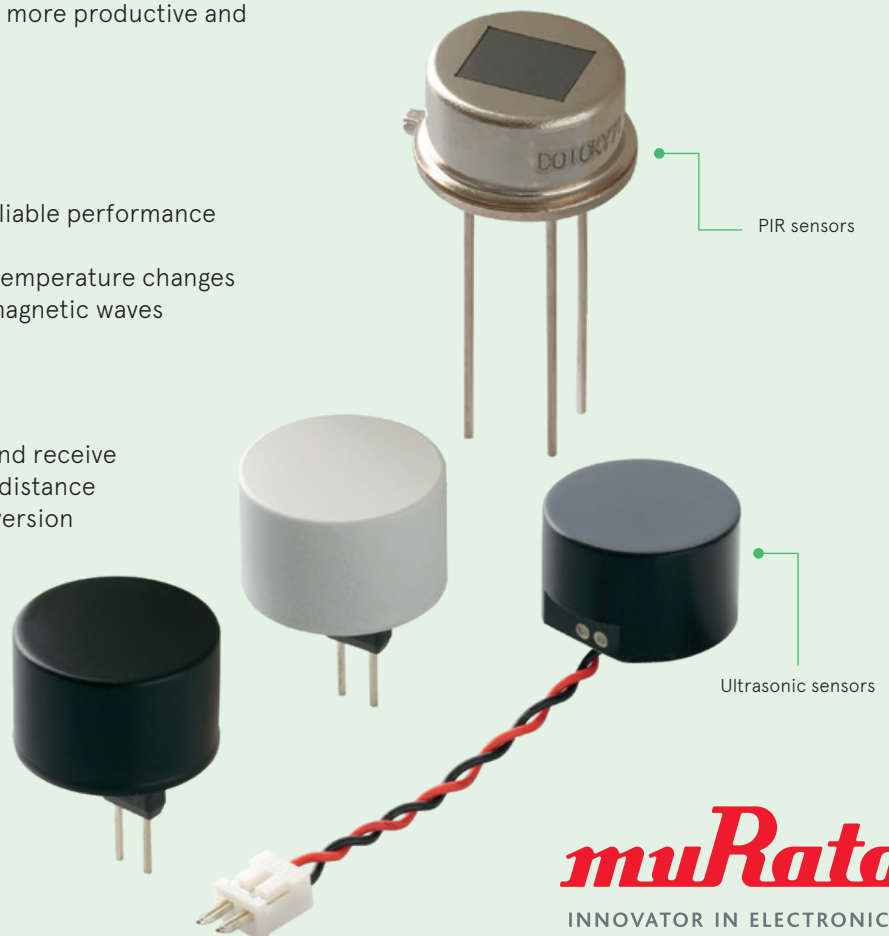

For more information visit  
[avnet-abacus.eu/murata](http://avnet-abacus.eu/murata)

**muRata**  
INNOVATOR IN ELECTRONICS

## OMRON B3S sealed tactile switches

The OMRON B3S is a surface-mounting tactile switch with a sealed structure providing high reliability. The button gives the user a positive tactile feedback, contributing a quality feel to the user interface.

With a surface-mounting terminal, it is suitable for high-density mounting. It is also available with a ground terminal for protection against static electricity and in embossed taping packages for automatic mounting. The silver plated switch is sealed conforming to IP67 (IEC 60529) standards, providing high contact reliability in environments exposed to dust or water.

The B3S can withstand temperatures between  $-25^{\circ}\text{C}$  to  $+70^{\circ}\text{C}$  with no icing or condensation.

The B3S is perfect for applications including smart meters, ventilation and temperature control, lifts and elevators, as well as factory automation.



B3S tactile sealed switch

### FEATURES

- High precision, high contact reliability
- SMD for automatic production
- Longer lasting contact lifetime
- Dustproof sealed construction

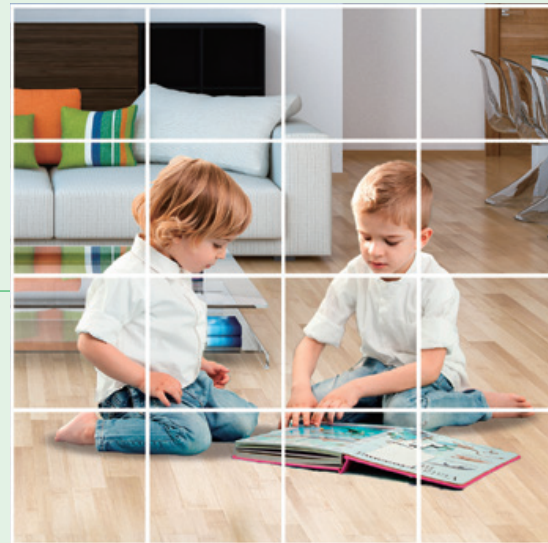

## OMRON D6T-32L MEMS thermal sensor

The OMRON D6T-32L is a MEMS thermal sensor enabling reliable presence and location detection of people in an area. Capable of detecting even the slightest amount of radiant energy from objects, the sensor can detect both stationary and moving people and objects. With a view across  $90^{\circ}$  by  $90^{\circ}$ , the D6T-32L is able to encompass a wide area from a single point.

D6T MEMS thermal sensors form a vital part of an effective infection control regime within buildings, rooms and crowd-controlled spaces by monitoring body temperature measurement and crowd density, and reducing the need to touch surfaces. They also offer exceptional control and sensing technology for lighting systems in building automation.

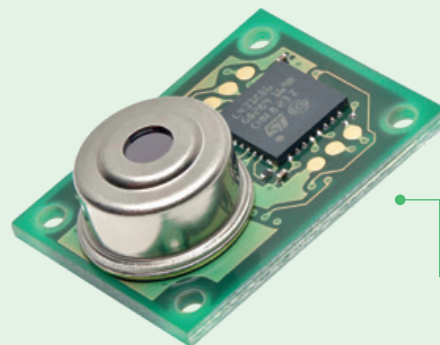

D6T-32L thermal sensor

For more information and to download the white paper visit [avnet-abacus.eu/omron](http://avnet-abacus.eu/omron)



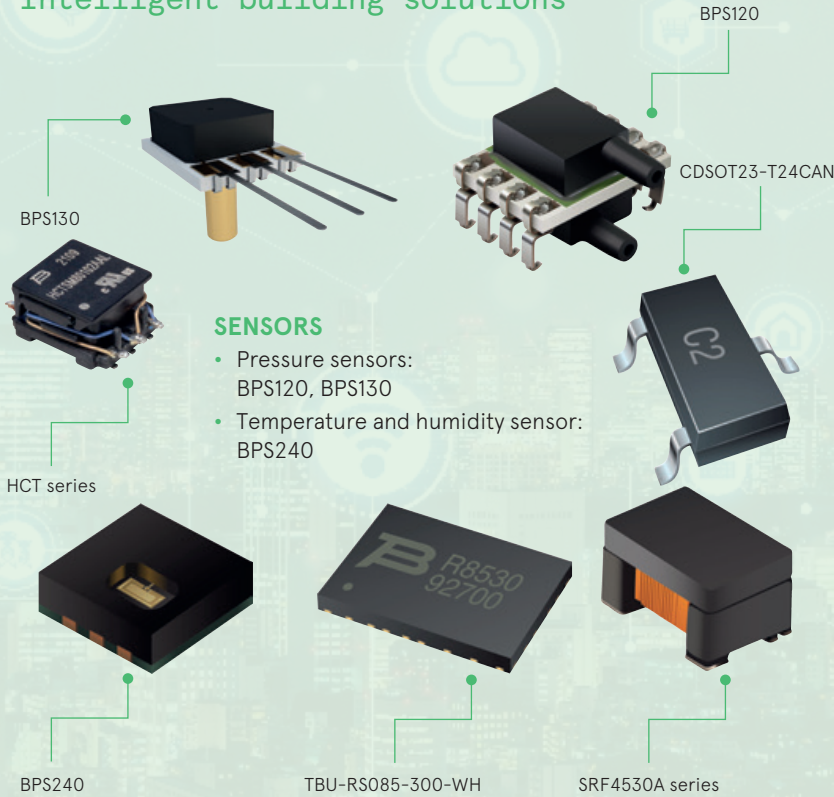

**SENSORS**

- Pressure sensors: BPS120, BPS130
- Temperature and humidity sensor: BPS240

**CONNECTIVITY**

- RS-485: TBU-RS
- Ethernet: SM453229-231N7Y (chipLAN)
- CanBus: CDSOT23-T24CAN (TVS array), SRF4530A (common-mode choke)

**DC POWER SUPPLIES**

- SRP power inductors
- Isolation transformers: HCT series (high isolation transformers)



For more information visit [avnet-abacus.eu/bourns](http://avnet-abacus.eu/bourns)



**AVNET**<sup>100</sup> YEARS

Reach Further<sup>®</sup> Together

**REACHING FURTHER TOGETHER**  
**Here's to 100 years - and counting!**

# From AC to DC: powering intelligent buildings



**There is a lot of interest in how to power the electronic and electrical devices in buildings of the future. Not just limited to energy savings, it includes how to integrate new energy sources such as solar, wind turbines and batteries with their DC outputs.**

Most electronics require DC at board level and even motor-driven AC machines such as washers and dryers are giving way to intelligent, inverter-driven versions that operate internally from a high voltage DC bus. In parallel, buildings are becoming 'smarter' for added convenience, productivity and reduced energy consumption. This only means yet more DC-powered electronics, widely distributed in sensors, actuators and controls, interconnected in the IoT.

All this begs the question – “Why not supply buildings with DC, not AC?”

## **AC v DC – “The war of the currents”**

Let's backtrack a little and look at why historically AC is used. DC was originally favoured in the US, as championed by Edison, but in the 'War of the Currents' Tesla's AC generators, with their ability to easily convert up and down voltage through transformers, outweighed

the advantage of DC – no transmission losses from dielectric and skin effects. As AC could be transformed up to hundreds of kV with consequent low current, losses became less of a problem anyway. So, AC won out and has dominated for the last 150 years, with a vast infrastructure built around it.

## **Grids of the future will be localised**

Using the existing infrastructure becomes less of a factor as nano, micro and mini grids are considered for the future with local renewable energy sources – typically DC-output solar arrays coupled with storage for continuity of supply. This might be a wall-mounted lithium-ion battery or even the household EV, with a bi-directional charger (Figure 1). The advantage of the arrangement is less reliance on the utility supply, lower bills, potential feed-in of excess energy to the grid and a smaller environmental footprint.

In the DC-powered home, voltages needed range from less than 0.6VDC for the CPU in your PC to perhaps 385VDC to drive a dishwasher motor inverter effectively and retain some backward compatibility with AC input versions.



Philip Lechner

Technical Specialist Power  
Avnet Abacus

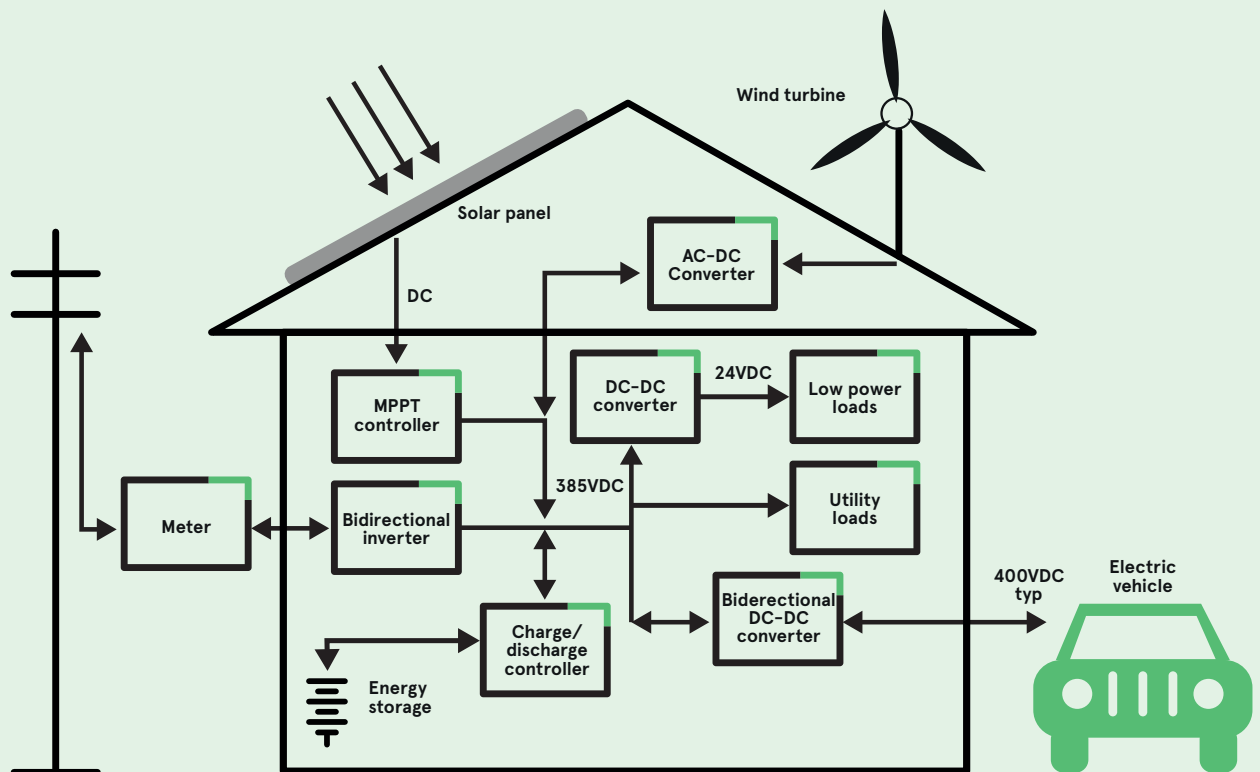

Figure 1: the DC powered home



## From AC to DC: powering intelligent buildings

A standard bus voltage or perhaps two in tandem, needs to be chosen. Then DC-DC converters will be required at many loads and at sources such as solar panels and wind turbines with their variable output voltage, or the EV battery which could be 800VDC. Ironically, DC-DC converters operate by generating AC to feed a transformer to change voltage and provide isolation. Calculations have shown however, that overall efficiency with DC input equipment can be between 5% and 20% better <sup>[1]</sup>.

Voltages being considered for building DC buses are 385VDC as in data centres and 24VDC. The former because this is the peak value of rectified and power factor-corrected AC, at high tolerance, present in 'universal' AC input products. In many cases, 385VDC applied to the AC input will effectively disable the PFC stage and pass straight through, with the equipment operating as normal. Products operating from 385VDC will take approximately the same current as from 240VAC. So, although existing cabling would be of adequate rating, it can't be used as it is colour-coded for AC and standards for DC, when they exist, will mandate different colours to avoid confusion. Legacy universal AC input products without power factor correction (such as lighting power supplies below 25W and other equipment below about 75W) will usually operate satisfactorily with 385VDC, at the top end of their rated input, but in the DC home new low power products are likely to be rated for operation off a lower voltage bus for convenience.

### DC input equipment requires special fusing and switching design

Fusing for DC input products is an important consideration. With an overload on an AC power line, a fuse will open and the momentary arc will quickly

extinguish as it does so, as AC crosses zero volts every 10 milliseconds for a 50Hz supply. In a DC line, the arc can continue for much longer and even be self-sustaining, depending on the separations and fuse type. To avoid this and consequent equipment stress and safety concerns, DC and AC fuses have different construction. In the extreme, circuit breakers are used, sometimes using magnetic or compressed air deflection of the arc to extinguish it more quickly. Solid state circuit breakers are also an option and are reducing in price. A longer arc is also drawn when mating or un-mating DC power connectors in normal operation, risking burning or even welding of the contacts closed. The same situation occurs with switch contacts.

The solution, which is now standard in EV charging connectors, is to incorporate an additional control connection. This forms an interlock to ensure that high current is disabled while mating or un-mating. If existing products are marketed as AC or DC compatible, a practical solution will be to use separate inlet connectors.

With a direct DC connection to equipment, there will often be an energy storage element on its internal DC line, such as a bulk 'reservoir' capacitor, which can store many joules of energy. In AC-input products, this capacitor is isolated from the input by the line rectifier. Safety standards can be easily met to reduce the residual voltage on the AC terminals to a safe value within one second (Figure 2). With DC input and no rectifier, the input connection could be at full 385VDC and take minutes or longer to discharge internally, posing a safety concern, especially as the equipment connection is likely to have exposed 'male' contacts. A diode fitted in line internally is a solution, also protecting against reverse polarity, but it reduces efficiency.

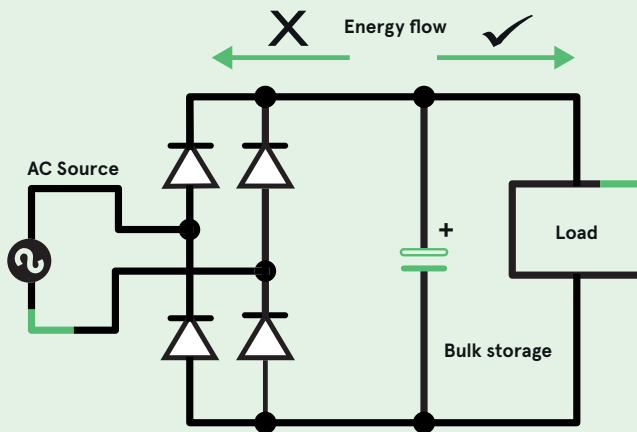

Figure 2: rectifiers on AC input equipment isolate energy storage components

A MOSFET however can be used as an isolator with low loss.

24VDC is another option as a building power bus, with some history in control electronics and sensors in industry. This is only suitable for low power, however, as currents are over 15 times higher than 385VDC systems for the same power rating. An advantage though is that 24V is 'Extra Low Voltage' (ELV) which means it is deemed inherently low risk for electric shock, wiring does not have to be installed by certified electricians and can be re-located quickly and cheaply. Depending on the power source, however, 24VDC could still supply dangerously high currents leading to overheating, injury and fire, so standards will be imposed for installation practice and protection methods [2]. 24VDC is useful for LED lighting, IoT nodes, sensors, controllers and other low power electronics with internal DC-DC converters. It has been written that a voltage such as USB 5V for portable appliance charging could be generated centrally from 385VDC or 24VDC and distributed out across a building. However this will not be viable, as the voltage must be quite accurate at the load, and droops, spikes, and surges on a 5V bus would be unacceptable. Devices also often need individual intelligent control of voltage and current sourcing as in the USB-C standard, so, in practice, we will still see individual USB chargers, but fed perhaps from 24VDC rather than AC mains.

This will make them cheaper, smaller without the worry of safety clearances and easier to integrate into connector wall plates.

#### A grounding scheme must be chosen

DC buses in buildings, like AC systems, will need a defined relation to ground for safety and functional reasons; un-grounded arrangements could 'float' up to damaging voltages and produce indeterminate electromagnetic interference levels from the array of switching DC-DC converters now connected. Some equipment may have an internal connection to ground already; for example, solar panels can have grounded outputs, so it is likely that a firm connection to a central ground will be defined in a building electrical system, similar to AC neutral connecting to ground at a central point. In IT DC systems, the positive of a 48V bus is grounded, producing -48V as distributed power. This is to prevent galvanic corrosion of connections to ground in moist atmospheres, but in controlled industrial and domestic environments, this is less likely to be a concern and a positive bus with negative grounded is likely to be the preferred solution, though there are other options (Figure 3). Non-isolated DC-DCs off a positive bus are also preferred as they can be simple buck-converters, rather than less common 'buck-boost' types, which can operate off a negative input for positive output.



## From AC to DC: powering intelligent buildings

DC-connected buildings do therefore have their challenges, with embryonic standards and a complex payback calculation. This is heavily dependent on cost and availability of DC-powered equipment, especially in the transition period when volumes are low and a premium is imposed for dual-input products. As we move to carbon-free economies and energy efficiency must be maximised, however, Edison's dreams are more likely to become reality.

**References:**

- [1] <https://www.ase.org/blog/direct-current-power-systems-can-save-energy-so-building-developers-are-getting-new-incentive>
- [2] <https://www.theiet.org/media/2734/practical-considerations-for-dc-installations.pdf>

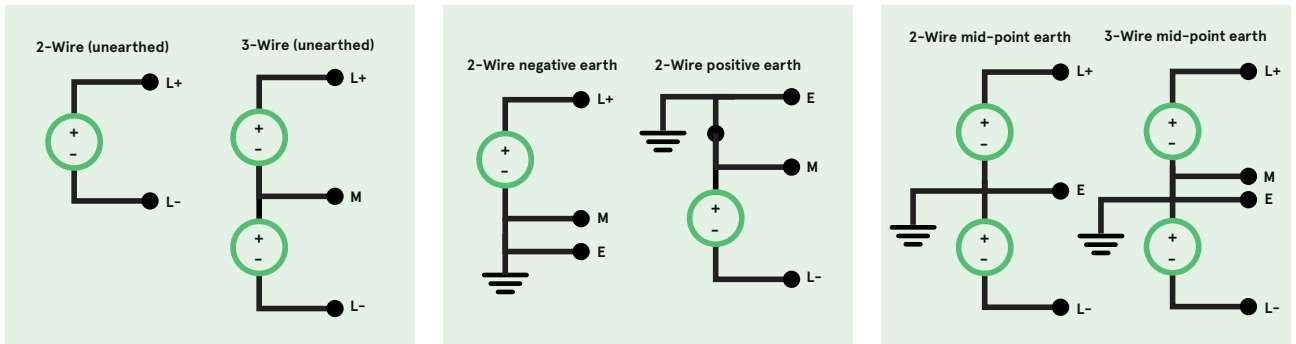

**Figure 3:** DC supply grounding options. Image reproduced with permission from G Kenyon Technology Ltd and The Institution of Engineering and Technology



## Better, Greener, Smarter Buildings

The world is undergoing an exponential acceleration in the pace of technological evolution and digital transformation, resulting in new opportunities for the improvement of the quality, sustainability and efficiency of our lives. Leveraging these opportunities in the connected real estate market is the crux of smart building technology.

### WHAT ARE SMART BUILDINGS?

Smart buildings use automated processes to control their operations, including heating, ventilation, air conditioning, lighting and security systems. The concept of a smart building has existed for many years; the technology needed to make it practical is now available.

### THE NEED FOR SEAMLESS CONNECTIONS

Smart buildings require a significant increase in the number of internal systems that use multiple printed circuit board (PCB) and flex assemblies for sensors, cameras and multiple active module PCBs. Assemblies demand connectors with improved signal integrity (SI) for speed and robustness in tight spaces.

The next wave of features propelled by Industrial Internet of Things (IIoT) innovation will require increased internal PCB and flex assembly density. This will drive more modularity, with complex circuitry requiring additional semiconductors, memory, capacitors and resistors on multiple boards, increasing low-profile connector demand.

### MORE FEATURES NEED MORE POWER

Feature-rich devices require more power in the same space, demanding low-to-mid power connections. More applications will have low volt motors, lighting and power supplies that will require low-power connection points. The demand for space-savings with increased internal density will drive shifts from wire to board or flex to board in how the power is supplied into the board.

### REAL-TIME INFORMATION REQUIRES FASTER CONNECTIONS

Sensors and cameras are processing and interpreting more information at higher processing speeds, requiring connectors with superior SI performance. Higher resolution displays require increased EMI and SI performance. Antenna bands have evolved to drive more information at higher processing speeds, requiring more active and passive components.

### SPACE CONSTRAINTS NEED PROFILE FLEXIBILITY

The inside profile of building automation applications is becoming more space constrained. Increased modularity limits the space from the connector and other components, requiring more profile and orientation micro connector options. Having multiple profile and orientation micro connector options gives designers and building managers flexibility to address space, location and connector entry-point challenges.

### THE MOLEX ADVANTAGE

Molex continues to offer a wide range of innovative products and services supported by decades of experience in designing cables, sensors and connectivity solutions for smart building applications. Our products and solutions are also backed by a comprehensive system performance warranty, giving you peace of mind that our solutions will support your needs over the long term.

Visit [avnet-abacus.eu/molex](http://avnet-abacus.eu/molex)

### HOW DO SMART BUILDINGS HELP CUT COSTS?

- Turn reactive HVAC and lighting systems into proactive ones, offering significant energy savings
- Can add years to your equipment's life with smart monitoring and predictive maintenance
- Feature unified network and wireless systems to speed up installations at lower costs
- Employ web and mobile monitoring that helps reduce travel and operating expenses
- Involve embedded computing that allows controller communication, decentralising decision making and enabling real-time responses
- Offer data insights to optimise further
- Minimise environmental impact of buildings





# Avnet Abacus' Power Masterclass Series

Six of the brightest minds and biggest players in power, discussing the latest struggles in power supply implementation

To watch all the sessions on demand, visit [avnet-abacus.eu/power-masterclasses](https://avnet-abacus.eu/power-masterclasses)

**AVNET**<sup>®</sup> ABACUS



# Molex names Avnet Abacus' Paul Jones 'Most Valued Performer'

News

focus

Paul Jones, Supplier  
Development Manager,  
Avnet Abacus

## molex

Paul Jones, Supplier Development Manager at Avnet Abacus, has earned well-deserved recognition from Molex, who have named him the 'Most Valued Performer' for his contribution to advancing Molex's business across Europe during 2020.

The award is given annually to the individual who has shown outstanding achievement in terms of driving business growth throughout the year.

**"We are very happy to be recognising Paul for his contributions in 2020"**, said Paul Keenan, Sales Director – Distribution Europe at Molex.

**"His collaboration with our sales teams has helped to elevate the Avnet Abacus and Molex relationship on both a local and regional level. He is truly focused on winning new business, and has done a tremendous job in driving Avnet Abacus' sales team to convert any opportunities. Congratulations again to Paul from the Molex team."**



AVNET® ABACUS

# Engineers' Insight: the Avnet Abacus blog

## Solving design challenges

Avnet Abacus' technical blog, Engineers' Insight, is designed to help you solve key challenges across the breadth of markets and technologies we serve.

From electronics phenomena such as equivalent series resistance in electrolytic capacitors, to discussions on the best approaches to new wireless technologies, to in-depth design guides for power solutions, this is a blog written for engineers, by engineers.

### Where to read?

[avnet-abacus.eu/engineers-insight](http://avnet-abacus.eu/engineers-insight)