



PolarFire® SoC FPGAs

Architecture, Applications, Security Features,
Design Environment, Design Hardware



Microchip extends its leadership in low-power FPGAs and SoC FPGAs with the cost-optimized PolarFire® SoC family. PolarFire SoC FPGAs deliver up to 50% lower power than equivalent SRAM SoC FPGAs. PolarFire SoC is built upon the award winning, non-volatile PolarFire FPGA platform and features a five-core Linux® capable processor subsystem based on the RISC-V ISA.

The RISC-V CPU micro-architecture implementation is a simple 5 stage, single issue, in-order pipeline that doesn't suffer from the Meltdown and Spectre exploits found in common out-of-order machines. All five CPU cores are coherent with the memory subsystem allowing a versatile mix of deterministic real time systems and Linux in a single multi-core CPU cluster.

With Secure Boot built-in, innovative Linux and real-time modes, a large Flexible L2 memory subsystem and a rich set of embedded peripherals, PolarFire SoC is ideally suited for secure, power-efficient compute in a wide range of applications within smart embedded vision, wireline access networks, cellular infrastructure, aerospace and defense, industrial automation, automotive and Internet of Things (IoT).

Addressing Key Market Opportunities

Communications

- Significantly improving network capacity and coverage with limited spectrum and CAPEX
- Growing IoT with minimal energy consumption
- Lowering physical and carbon footprint

Defense

- Providing battlefield portability and increased mission life
- Increasing automation in vehicles and weaponry
- Enhancing operator situational awareness
- Increasing cybersecurity
- Ensuring supply chain security

Industrial Automation

- Expanding factory automation networks
- Growing number of M2M sensors and nodes
- Securing decentralized computing
- Improving portability
- Achieving cyber security
- Improving functional safety



Smart Embedded Vision

- Delivering 4K video and smart imaging
- Applying AI/ML
- Applying imaging to portable products
- Extending battery life
- Eliminating thermal fans and heatsinks
- Achieving secure surveillance

Automotive

- Delivering determinism to driver-assist systems
- Increasing vehicle automation
- Growing AI/ML implementations
- Lowering power consumption

Internet of Things

- Ensuring lowest power, most secure, edge and gateway devices
- Enabling data processing at the edge, distributed networking systems
- Increasing IoT automation and networking
- Delivering maximum performance with lowest carbon footprint



PolarFire SoC Advantages

Lowest Power and Superior Performance

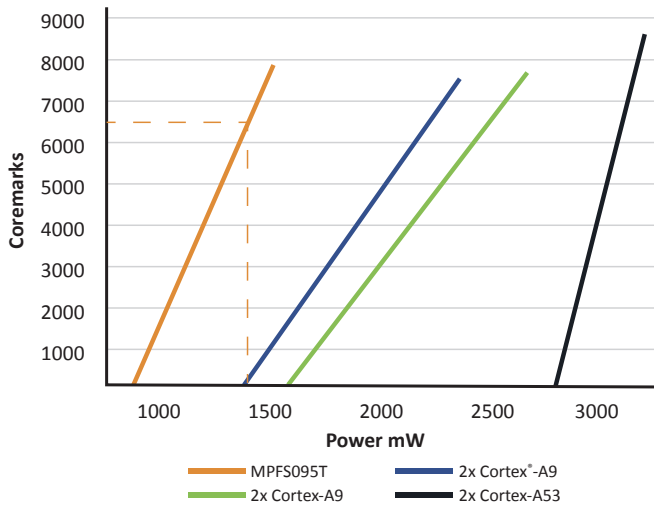

PolarFire SoC delivers significant power saving while outperforming SRAM based SoC FPGAs.

- PolarFire SoC offers
 - 6.5k Coremarks @ 1.3W while similar sized SRAM based SoC FPGAs deliver 0
 - Up to 60% lower power
 - More FPGA memory and DSP resources
- PolarFire SoC is the only mid-range SoC FPGA to offer
 - DDR3/4, LPDDR3/4 support
 - 12.7 Gbps transceivers
 - Cost efficient SGMII for GbE
 - 2x PCIe® Gen 2 (x1, x2, x4)
 - Smallest formfactor solutions starting from 11 mm x 11 mm in a FCSG325 package.

Microprocessor Subsystem Performance

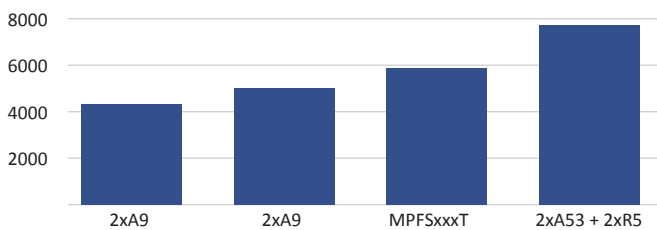

PolarFire SoC delivers more or similar total DMIPS compared to competitive SRAM based SoC FPGAs.

- Large 2 MB L2 Cache
 - Increases system performance for rich OS
 - Deterministic mode for real-time
- AMBA switch with built-in quality of service
- PolarFire SoC's RISC-V cores are configurable as an application processor or a real-time processor and delivers max performance in either configuration

Determinism (AMP Mode)

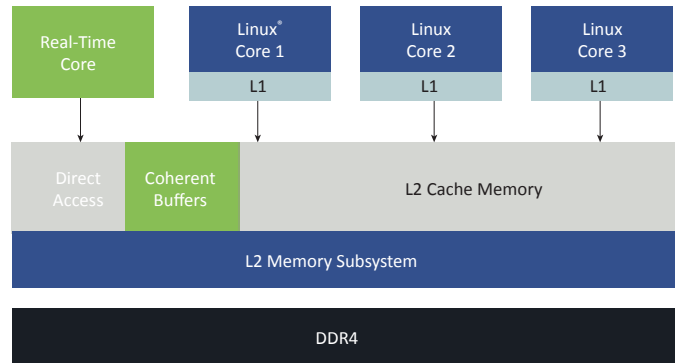

- L1 and L2 configurable as a deterministic memory
- Disable/enable branch predictors
- 5 stage in-order pipeline
- Run a rich OS and hard real-time in a coherent CPU cluster

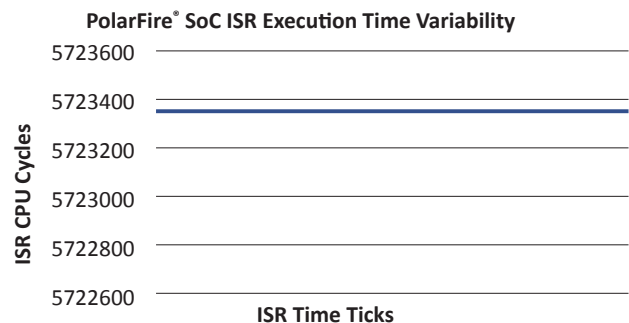
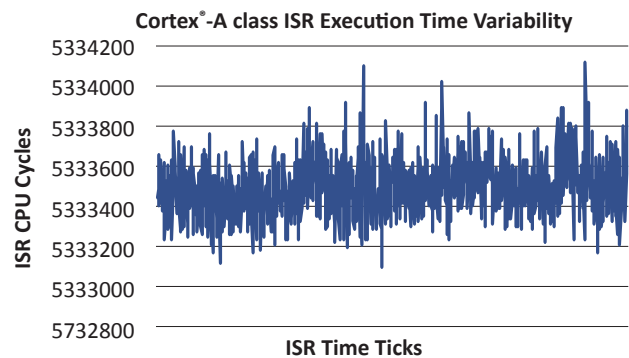

Smallest Form Factors

PolarFire SoC FPGAs offer best-in-class form factors at 25k, 95k, 160k and 250k LEs.

- **FCSG325:** 11 mm x 11 mm, Pitch 0.5 mm
- **FCSG325:** 11 mm x 14.5 mm, Pitch 0.5 mm
- **FCSG536:** 16 mm x 16 mm, Pitch 0.5 mm
- **FCVG484:** 19 mm x 19 mm, Pitch 0.8 mm
- **FCVG784:** 23 mm x 23 mm, Pitch 0.8 mm
- **FCG1152:** 35 mm x 35 mm, Pitch 1 mm

Mid-Range FPGA Platform Optimized for Low Power

- High-speed serial connectivity with built-in multi-gigabit/multi-protocol transceivers from 250 Mbps to 12.7 Gbps
- Up to 461k logic elements consisting of a 4-input Look-Up Table (LUT) with a fracture-able D-type flip-flop
- Up to 31.6 Mb of RAM
- Power optimized transceivers
- Up to 1420 18 × 18 multiply accumulate blocks with hardened pre-adders
- Integrated dual PCIe for up to ×4 Gen 2 Endpoint (EP) and Root Port (RP) designs
- High-Speed I/O (HSIO) supporting up to 1600 Mbps DDR4/LPDDR4, 1333 Mbps DDR3L, DDR3/LPDDR3 memories with integrated I/O gearing
- General Purpose I/O (GPIO) supporting 3.3V built-in CDR to support SGMII for serial gigabit Ethernet, and 1600 Mbps LVDS I/O speed with integrated I/O gearing logic
- Instant on, non-volatile technology offers 50% lower power vs. equivalent SRAM FPGAs
- Up to 50% lower power

Versatile, Low-Power Multi-Core RISC-V CPU Sub-System

- 64-bit multi-core CPU cluster
- Linux and real-time in a deterministic and coherent CPU cluster
- Integrated DDR3/4, LPDDR3/4 controller and phy
- Defense grade secure boot
- Spectre and meltdown immune
- Physically unclonable function
- Physical memory protection
- SECDED on all memories
- Low static power
- Low-power CPU cluster
- Smallest form factors
11 × 11, 16 × 16, 19 × 19

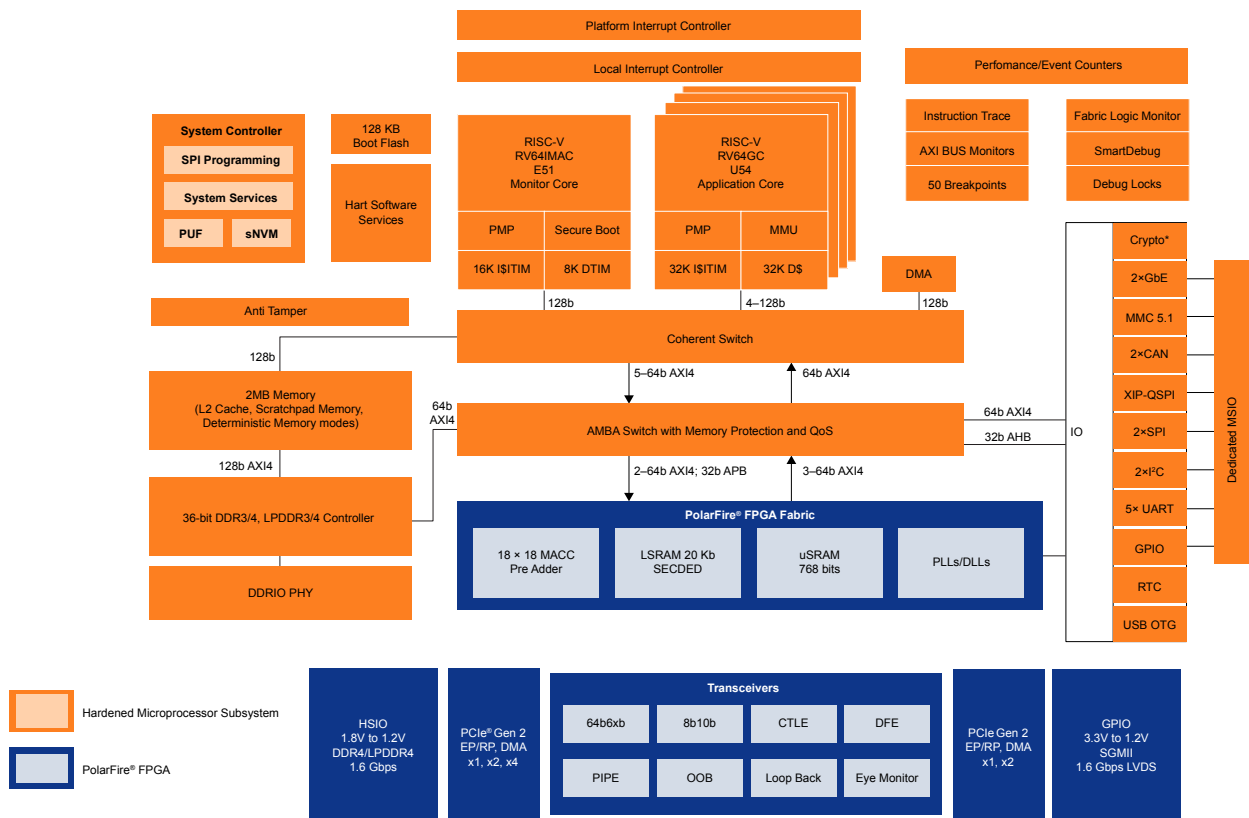

*DPA-Safe Crypto co-processor supported in S devices
**SECDED supported on all MSS memories

Industry's Best SoC FPGA Security

Cyber Security is the #1 Concern for Connected Devices on the Network Edge

It is not enough for today's demanding applications to meet the functional requirements of their design—they must do so in a secured way. Security starts during silicon manufacturing and continues through system deployment and operations. Microchip's PolarFire SoC FPGAs represent the industry's most advanced secure programmable FPGAs.

| Security Features | PolarFire SoC | Competitor 1 | Competitor 2 | Competitor 3 |
|----------------------|---|---|---|---|
| TRNG | Hard-IP (SP800-90A CTR_DRBG-256; SP800-90B (draft) NRBG) | ☒ | ☒ | Soft-IP |
| AES | AES-128/192/256 (ECB, CBC, CTR, OFB, CFB, GCM, KeyWrap) | AES-256 (CBC) | AES-256 (CBC) | AES-256 (ECB, GCM) |
| SHA | SHA-1/224/256/384/512, Key Tree | SHA-256 | SHA-256 | SHA-384 |
| HMAC | HMAC-SHA-1/224/256/384/512; GMAC-AES; CMAC-AES | HMAC-SHA2-256 | HMAC-SHA2-256 | ☒ |
| RSA | SigGen (ANSI X9.31, PKCS v1.5), SigVer (ANSI X9.31, PKCS v1.5)-1024/1536/2048/3072/4096 | Soft-RSA -(2048) SigGen(PKCS v1.5), SigVer (PKCS v1.5) | Soft-RSA -(2048) SigGen(PKCS v1.5), SigVer (PKCS v1.5) | Software library - RSA primitive (2048) |
| ECDSA | KeyGen, KeyVer, SigGen & SigVer - NIST & Brainpool (P256/384/521) KAS - ECC CDH, PKG, PKV | ☒ | ☒ | ☒ |
| FFC | KAS - DH, DSA SigGen & SigVer (1024/1536/2048/3072/4096) | ☒ | ☒ | ☒ |
| Tamper Sense | Voltage, Temperature, Clock Frequency, Clock Glitch, Active Mesh | ☒ | ☒ | Only Voltage & Temperature |
| PUF | PUF protection for Secure Key storage (Secure Boot and Data communication) | ☒ | ☒ | For secure boot key |
| Bitstream Protection | DPA resistant Encrypted bit-stream programming | ☒ | ☒ | ✓ |
| DPA Resistance | DPA resistant hard crypto co-processor supporting all above Crypto algorithms | ☒ | ☒ | ☒ |

Defense Grade Security

- Secure Hardware
 - Secure wafer sort and packaging
 - Spectre and Meltdown immune CPUs
- Design security
 - DPA-resistant bitstream programming
 - Anti-tamper
 - DPA-resistant secure boot
- Data security
 - CRI DPA countermeasures pass through license
 - DPA-resistant crypto-coprocessor

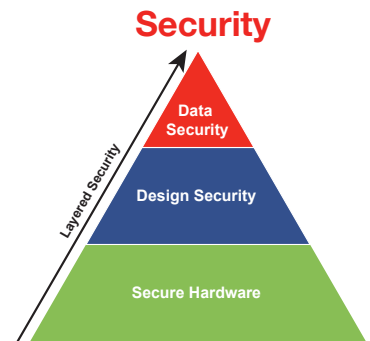

PolarFire SoC Physical Memory Protection

PolarFire SoC has Physical Memory Protection (PMP) implemented in each of the processor cores. PMP is used to enforce (read, write, execute) restrictions on less privileged modes. PolarFire SoC can restrict access rights of un-trusted user mode software.

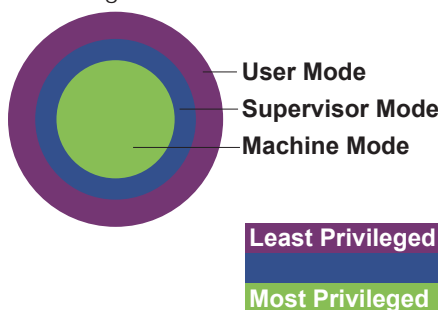

PMP Implementation in PolarFire SoC

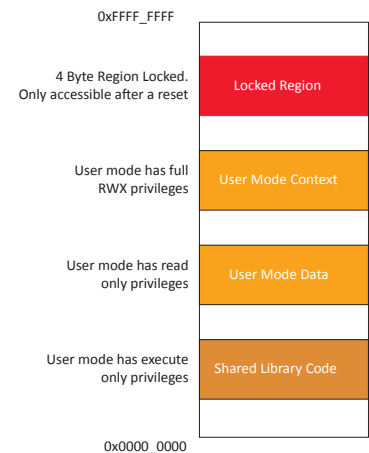

Design Flow and Tools

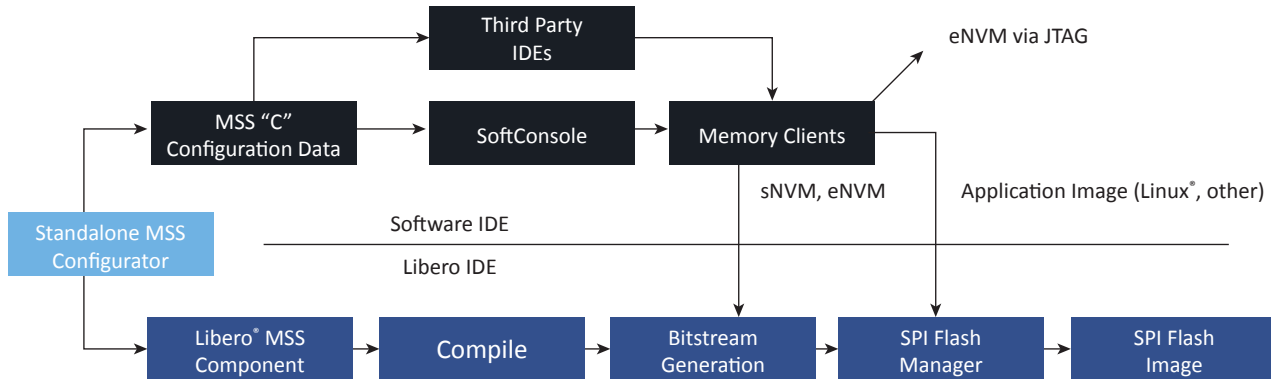

MSS Configurator

PolarFire SoC MSS Configurator is the tool to configure the processor subsystem and generate a Libero® component.

- Presets for SMP Linux, Real-time and AMP modes
- Generates C data structures to initialize the memory map for the embedded environment
- Generates a Libero MSS component for the FPGA design

Libero SoC Design Suite

Microchip enhances design productivity by providing an extensive suite of proven and optimized IP cores for use with Microchip FPGAs and SoCs. Our extensive suite of IP cores covers all key markets and applications. Our cores are organized as either Microchip-developed DirectCores or third-party developed CompanionCores. Most DirectCores are available for free within the Libero SoC Design Suite and include common communications interfaces, peripherals, and processing elements.

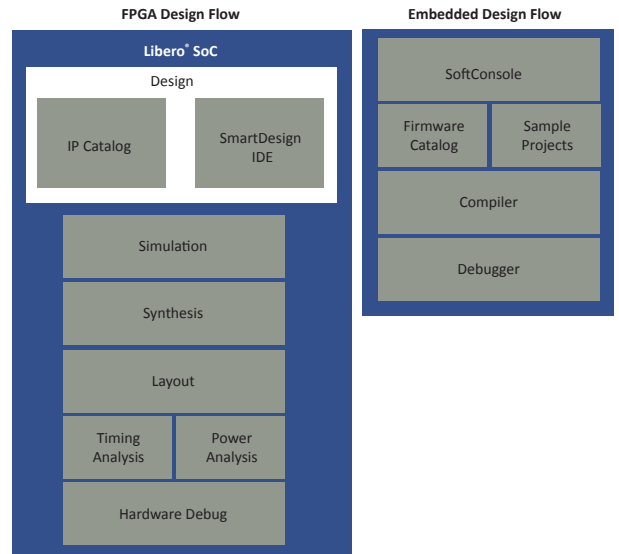

SoftConsole

Microchip's SoftConsole is a free, Eclipse-based development environment for rapid development of bare-metal and RTOS based embedded firmware. SoftConsole supports development and debug for all Microchip FPGAs (with soft CPUs) and SoC FPGAs.

SoftConsole 6.x also integrates Antmicro's Renode emulation platform that supports Mi-V soft-CPU's and PolarFire SoC models.

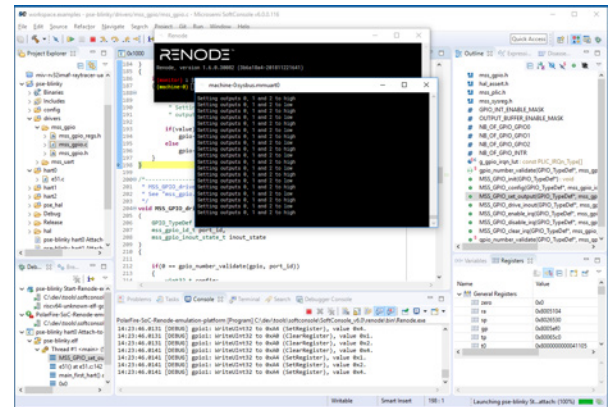

SmartDebug

SmartDebug offers the equivalent of an oscilloscope inside Microchip FPGAs and SoCs. SmartDebug features a tool called LiveProbes that enables an engineer to see any two nodes inside the FPGA, on external pins, without requiring recompilation of a design. Nodes can be quickly selected and modified, and the real-time signals can be seen externally immediately. This SmartDebug capability can cut debug time significantly. In addition, the SmartBERT module allows customers to configure and monitor the built-in PMA tester.

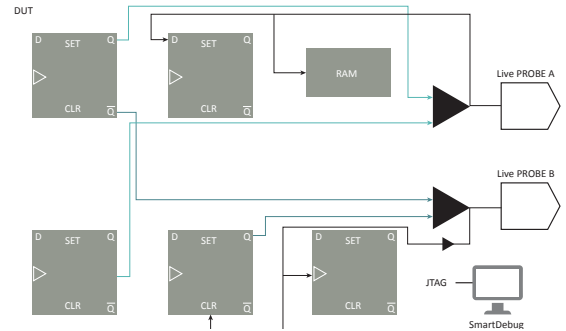

Trace, Bus Monitors and Software Debug

SoftConsole integrates an interactive GUI tool that provides a convenient and user-friendly way to configure debug modules, analyze trace and counter data, load and debug embedded software and view system state.

Trace

PolarFire SoC supports instruction trace for individual cores. Trace data support is available over Ethernet, JTAG and to the FPGA Fabric.

Dynamic AXI Bus Monitor

Dynamic AXI Bus Monitors can be used to monitor the traffic over an AXI bus, interpret bus protocol, identify transactions of interest using filters and initiate actions. PolarFire SoC supports Dynamic Bus Monitors that are passive and run-time configurable. Dynamic bus monitors are available on two AXI busses.

- The L2 cache bus monitor can be used to monitor the traffic to the L2 cache
- The AMBA switch bus monitor can be used to monitor traffic between the processor, fabric, peripherals and the DDR controller.

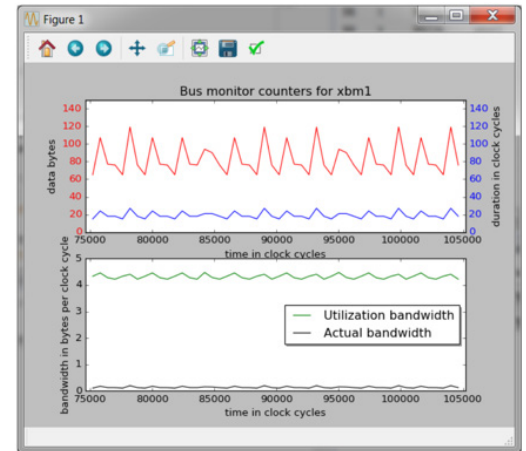

Performance Monitors

PolarFire SoC includes performance monitors that can be activated upon transaction events. The supported metrics include bus cycles, transactions, duration, bytes, beats, latency, hesitancy and bus concurrency. The performance monitors include:

- 2x 40-bit event counting CSRs
- 2x event selector CSRs
- Multiple event-selects per counter

Software Debug

PolarFire SoC supports up to 10 hardware breakpoints/watchpoints per core with instruction and data address matches. SoftConsole's debug environment may be used for software debug.

| Machine Hardware Performance Monitor Event Register | |
|---|--|
| Instruction Commit Events, mhpeventX[7:0] = 0 | |
| Bits | Meaning |
| 8 | Exception taken |
| 9 | Integer load instruction retired |
| 10 | Integer store instruction retired |
| 11 | Atomic memory operation retired |
| 12 | System instruction retired |
| 13 | Integer arithmetic instruction retired |
| 14 | Conditional branch retired |
| 15 | JAL instruction retired |
| 16 | JALR instruction retired |
| 17 | Integer multiplication instruction retired |
| 18 | Integer division instruction retired |
| 19 | Floating-point load instruction retired |
| 20 | Floating-point store instruction retired |
| 21 | Floating-point addition retired |
| 22 | Floating-point multiplication retired |
| 23 | Floating-point fused multiply-add retired |
| 24 | Floating-point division or square-root retired |
| 25 | Other floating-point instruction retired |
| Microarchitectural Events, mhpeventX[7:0] = 1 | |
| Bits | Meaning |
| 8 | Load-use interlock |
| 9 | Long-latency interlock |
| 10 | CSR read interlock |
| 11 | Instruction cache/ITIM busy |
| 12 | Data cache/DTIM busy |
| 13 | Branch direction misprediction |
| 14 | Branch/jump target misprediction |
| 15 | Pipeline flush from CSR write |
| 16 | Pipeline flush from other event |
| 17 | Integer multiplication interlock |
| 18 | Floating-point interlock |
| Memory System Events, mhpeventX[7:0] = 2 | |
| Bits | Meaning |
| 8 | Instruction cache miss |
| 9 | Data cache miss or memory-mapped I/O access |
| 10 | Data cache writeback |
| 11 | Instruction TLB miss |
| 12 | Data TLB miss |

Linux SDK

Microchip's PolarFire SoC's Linux SDK is available in Yocto and Buildroot environments. The SDK comes with support for system firmware that handles Secure system boot, Secure bootloader, Crypto services and inter-CPU messaging. The SDK includes driver support for all the Microprocessor sub-system peripherals and common Soft-IPs supported for the FPGA fabric.

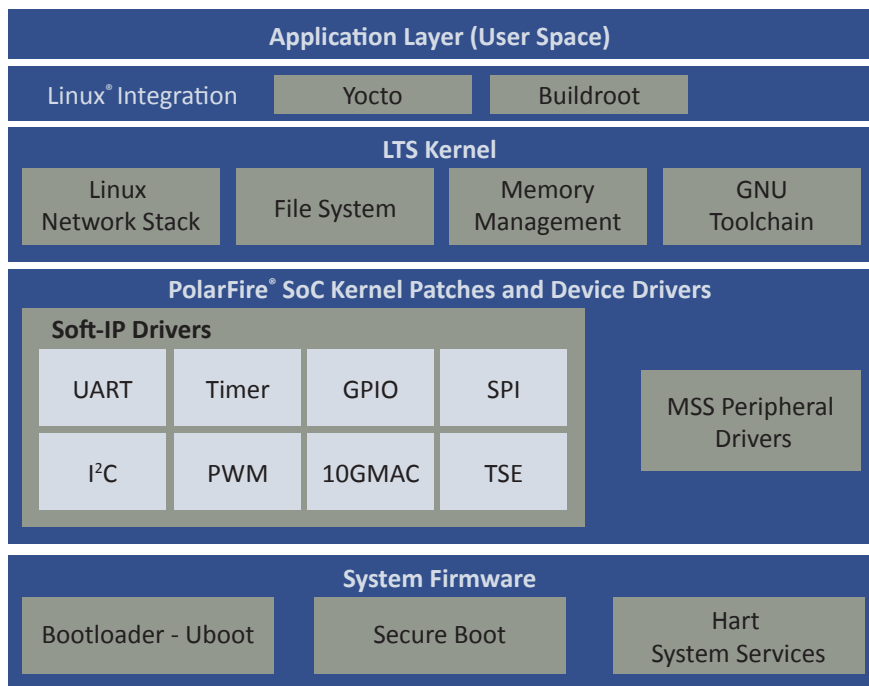

PolarFire SoC Real-Time Operating Systems

Microchip extends support for various open-source and commercial Real-Time Operating Systems (RTOS) for PolarFire SoC. Users may choose to use Microchip's free eclipse based SoftConsole development environment or third-party environments to develop their baremetal/RTOS based embedded firmware. Open-source RTOS ports on PolarFire SoC are available as example projects. Commercial RTOSs that include advanced scheduling, memory management and file systems are available from corresponding vendors. The following open-source and commercial RTOS's have been ported on PolarFire SoC.



Mi-V Ecosystem is Part of the Larger RISC-V Ecosystem Tailored for PolarFire SoC

Porting embedded applications can be a chore, after all no two SoCs are identical. The effort to port from one SoC to another is the same regardless of the underlying ISA. Linux abstracts the ISA away from the developer and our Yocto and BuildRoot projects help customers fork for their own projects. Mi-V Ecosystem consists of partners providing various solutions that can help you jumpstart your designs.

Operating Systems



RTOS



Compilers



Middleware



Mi-V Design Partners and SoM Vendors



Features and Packaging Overview of the PolarFire SoC FPGA Family

Extended Commercial (0°C to 100°C) and Industrial (-40°C to 100°C) Temperature Support for all Die Package Combinations – RoHS only.

| | Features | MPFS025T | MPFS095T | MPFS160T | MPFS250T | MPFS460T |
|---------------|---------------------------------------|-------------------------------|---------------|---------------|----------------|----------------|
| FPGA Fabric | k Logic Elements (4LUT + DFF) | 23 | 93 | 161 | 254 | 461 |
| | Math Blocks (18 × 18 MACC) | 68 | 292 | 498 | 784 | 1420 |
| | LSRAM Blocks (20K bit) | 84 | 308 | 520 | 812 | 1460 |
| | uSRAM Blocks (64 × 12) | 204 | 876 | 1494 | 2352 | 4260 |
| | Total RAM Mbits | 1.8 | 6.7 | 11.3 | 17.6 | 31.6 |
| | uPROM Kbits | 194 | 387 | 415 | 470 | 553 |
| | User DLL's/PLL's | 8 each | 8 each | 8 each | 8 each | 8 each |
| High Speed IO | 250 Mbps to 12.5 Gbps SERDES Lanes | 4 | 4 | 8 | 16 | 20 |
| | PCIe Gen2 End Points/Root Ports | 2 | 2 | 2 | 2 | 2 |
| Total FPGA IO | HSIO+GPIO | 108 | 276 | 312 | 372 | 468 |
| Total MSS IO | MSS IO | 136 | 136 | 136 | 136 | 136 |
| MSS DDR | Data Bus | 16 | 32 | 32 | 32 | 32 |
| | Type (Size, Pitch) | MSS IO/HSIO/GPIO/XCVRs | | | | |
| Packaging | FCSG325 (11 × 11, 11 × 14.5*, 0.5 mm) | 102/32/48/2 | 102/32/48/2 | 102/32/48/2* | | |
| | FCSG536 (16 × 16, 0.5 mm) | | 136/60/108/4 | 136/60/108/4 | 136/60/108/4 | |
| | FCVG484 (19 × 19, 0.8 mm) | 136/60/48/4 | 136/60/84/4 | 136/60/84/4 | 136/60/84/4 | |
| | FCVG784 (23 × 23, 0.8 mm) | | 136/144/132/4 | 136/144/168/8 | 136/144/180/8 | |
| | FCG1152 (35 × 35, 1.0 mm) | | | | 136/144/228/16 | 136/180/288/20 |

PolarFire SoC IP Portfolio

Microchip enhances your design productivity by providing an extensive suite of proven and optimized IP cores for use with Microchip FPGAs and SoCs. Our extensive suite of IP cores covers all key markets and applications. Our cores are organized as either Microchip-developed DirectCores or third-party developed CompanionCores. Most DirectCores are available for free within our Libero SoC Design suite and include common communication interfaces, peripherals, and processing elements.

PolarFire SoC Soft-IPs

- Bus Interface
 - AXI, AHB, AHBL, APB3, interconnects and bridges
- Memory interface
 - SRAM, QDR II+, DDR3, LPDDR3, DDR4, MMC
- Communication
 - JESD204BRX, JESD204BTX, RSDEC, RSENC, LiteFast, EDAC, CPRI v6.1, TCAM
- Security
 - DES, 3DES, Crypto and Tamper configurators
- DSP/Math
 - FIR, LNSQRT, DDS, Complex Multiplier, FFT, CIC
- Soft-CPU's
 - MiV_RV32IMAF_L1_AHB, MiV_RV32IMA_L1_AHB, MiV_RV32IMA_L1_AXI, JTAG, BootStrap
- Peripherals
 - PWM, PCS, UART, GPIO, I2C, MDIO, SPI, RMII, Timer, DMA, LSM, SmartBERT, Core429, SGMII, TSE, PCIF, 10GBASE-R, 10GBASE-KR, XAUI, USXGMII, 1553BRT, SDITX/RX (SD/HD/3G), UHD_SDITX/RX (6G/12G)

PolarFire SoC Imaging and Video IP

- Bayer conversion (4K resolution)
- Video DMA
- Video scalar (4K resolution)
- Alpha blending
- Color space (YCbCr, RGB)
- Image sharpening filter
- Display enhancement (brightness/contrast/hue)
- Image edge detection
- Display controller (4K resolution)
- Pattern generator
- MIPI CSI-2 receiver decoder
- (Up to 1.5 Gbps per lane ×4 lanes, 4Kp60)
- MIPI CSI-2 Tx
- (Up to 1 Gbps per lane ×4 lanes, 4Kp30)
- HDMI 2.0 (Rx 1080p60, Tx 4kp60)
- SLVS-EC (supports 2.3 Gbps per lane ×2 lanes in RAW8 data type)
- CoaXpress v1.1 (6.25 Gbps down, 20.83 Mbps up connections, host and device IP)

PolarFire SoC Development Targets

Renode PolarFire SoC Emulation Platform

Antmicro's Renode emulation platform is integrated within SoftConsole 6.x development environment and supports microchip's RISC-V based Mi-V soft CPUs and PolarFire SoC models.

Renode is an opensource platform that offers

- A test-driven software development methodology
- Multiple connected virtual devices (multi-node) setups within the same simulated environment
- A high productive programming platform using C#
- Full visibility of simulated platform
- Unlimited integration and easy bundling

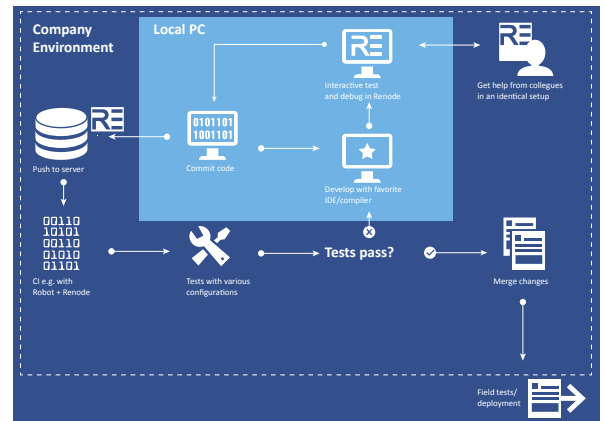

PolarFire SoC Icicle Kit Features (Part number MPFS-ICICLE-KIT-ES)

- PolarFire SoC MPFS250T-FCVG484EES
 - 254k LE non-volatile fabric
 - 784 – 18 x 18 math blocks
 - 5 – core RISC-V CPU subsystem (1xRV64IMAC, 4xRV64GC)
 - Secure boot
 - 4x 12.7 Gbps SERDES
 - FCVG484 package (19 x 19 mm, 0.8 mm pitch)
- Memory
 - LPDDR4 x 32
- Storage
 - QSPI Flash
 - eMMC Flash
- Connectivity
 - 2x GbE
- Expansion Ports
 - Raspberry Pi
 - mikroBUS™
- Interfaces
 - PCIe
 - USB 2.0
 - UART
 - SPI
 - I²C
 - CAN
- Sensor
 - Power sensor

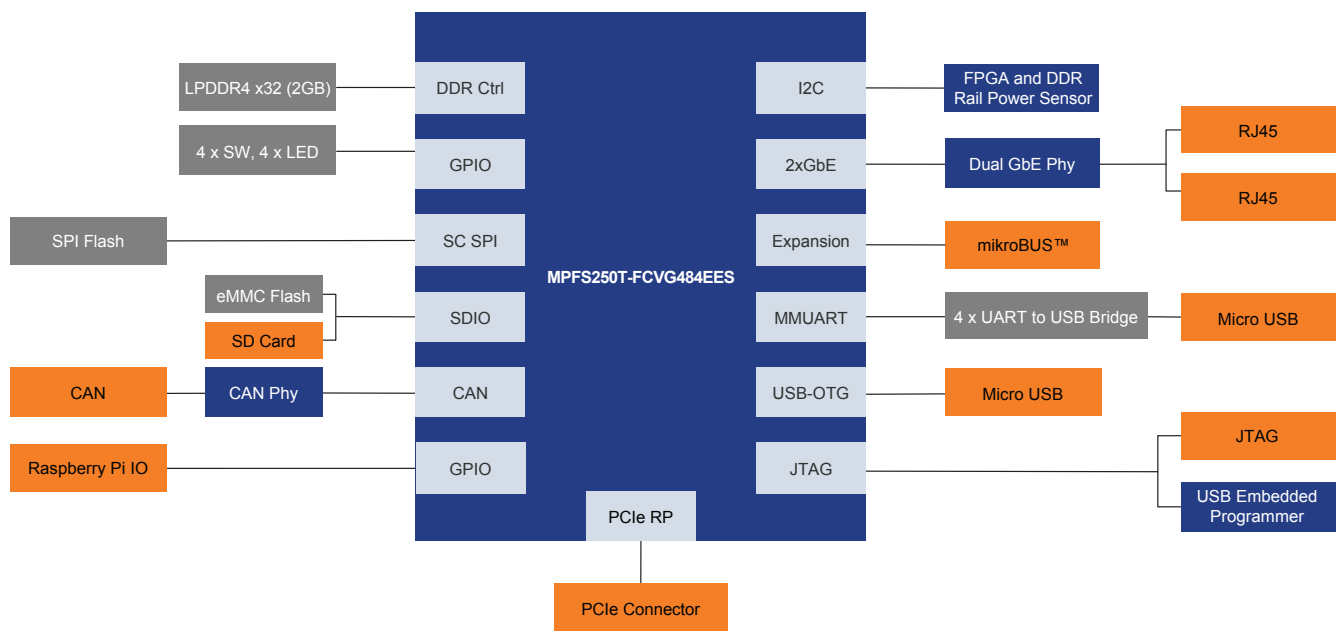

Questions about PolarFire SoC, email PolarFireSoC@microchip.com

Support

Microchip is committed to supporting its customers in developing products faster and more efficiently. We maintain a worldwide network of field applications engineers and technical support ready to provide product and system assistance. For more information, please visit www.microchip.com:

- Technical Support: www.microchip.com/support
- Evaluation samples of any Microchip device: www.microchip.com/sample
- Knowledge base and peer help: www.microchip.com/forums
- Sales and Global Distribution: www.microchip.com/sales

Training

If additional training interests you, Microchip offers several resources including in-depth technical training and reference material, self-paced tutorials and significant online resources.

- Overview of Technical Training Resources: www.microchip.com/training
- MASTERS Conferences: www.microchip.com/masters
- Developer Help Website: www.microchip.com/developerhelp
- Technical Training Centers: www.microchip.com/seminars

Sales Office Listing

AMERICAS

Atlanta, GA
Tel: 678-957-9614

Austin, TX
Tel: 512-257-3370

Boston, MA
Tel: 774-760-0087

Chandler, AZ (HQ)
Tel: 480-792-7200

Chicago, IL
Tel: 630-285-0071

Dallas, TX
Tel: 972-818-7423

Detroit, MI
Tel: 248-848-4000

Houston, TX
Tel: 281-894-5983

Indianapolis, IN
Tel: 317-773-8323
Tel: 317-536-2380

Los Angeles, CA
Tel: 949-462-9523
Tel: 951-273-7800

Raleigh, NC
Tel: 919-844-7510

New York, NY
Tel: 631-435-6000

San Jose, CA
Tel: 408-735-9110
Tel: 408-436-4270

Canada - Toronto
Tel: 905-695-1980

EUROPE

Austria - Wels
Tel: 43-7242-2244-39

Denmark - Copenhagen
Tel: 45-4485-5910

Finland - Espoo
Tel: 358-9-4520-820

France - Paris
Tel: 33-1-69-53-63-20

Germany - Garching
Tel: 49-8931-9700

Germany - Haan
Tel: 49-2129-3766-400

Germany - Heilbronn
Tel: 49-7131-67-3636

Germany - Karlsruhe
Tel: 49-721-62537-0

Germany - Munich
Tel: 49-89-627-144-0

Germany - Rosenheim
Tel: 49-8031-354-560

EUROPE

Israel - Ra'anana
Tel: 972-9-744-7705

Italy - Milan
Tel: 39-0331-742611

Italy - Padova
Tel: 39-049-7625286

Netherlands - Drunen
Tel: 31-416-690399

Norway - Trondheim
Tel: 47-7289-7561

Poland - Warsaw
Tel: 48-22-3325737

Romania - Bucharest
Tel: 40-21-407-87-50

Spain - Madrid
Tel: 34-91-708-08-90

Sweden - Gothenberg
Tel: 46-31-704-60-40

Sweden - Stockholm
Tel: 46-8-5090-4654

UK - Wokingham
Tel: 44-118-921-5800

ASIA/PACIFIC

Australia - Sydney
Tel: 61-2-9868-6733

China - Beijing
Tel: 86-10-8569-7000

China - Chengdu
Tel: 86-28-8665-5511

China - Chongqing
Tel: 86-23-8980-9588

China - Dongguan
Tel: 86-769-8702-9880

China - Guangzhou
Tel: 86-20-8755-8029

China - Hangzhou
Tel: 86-571-8792-8115

China - Hong Kong SAR
Tel: 852-2943-5100

China - Nanjing
Tel: 86-25-8473-2460

China - Qingdao
Tel: 86-532-8502-7355

China - Shanghai
Tel: 86-21-3326-8000

China - Shenyang
Tel: 86-24-2334-2829

China - Shenzhen
Tel: 86-755-8864-2200

China - Suzhou
Tel: 86-186-6233-1526

China - Wuhan
Tel: 86-27-5980-5300

China - Xiamen
Tel: 86-592-2388138

China - Xian
Tel: 86-29-8833-7252

ASIA/PACIFIC

China - Zhuhai
Tel: 86-756-321-0040

India - Bangalore
Tel: 91-80-3090-4444

India - New Delhi
Tel: 91-11-4160-8631

India - Pune
Tel: 91-20-4121-0141

Japan - Osaka
Tel: 81-6-6152-7160

Japan - Tokyo
Tel: 81-3-6880-3770

Korea - Daegu
Tel: 82-53-744-4301

Korea - Seoul
Tel: 82-2-554-7200

Malaysia - Kuala Lumpur
Tel: 60-3-7651-7906

Malaysia - Penang
Tel: 60-4-227-8870

Philippines - Manila
Tel: 63-2-634-9065

Singapore
Tel: 65-6334-8870

Taiwan - Hsin Chu
Tel: 886-3-577-8366

Taiwan - Kaohsiung
Tel: 886-7-213-7830

Taiwan - Taipei
Tel: 886-2-2508-8600

Thailand - Bangkok
Tel: 66-2-694-1351

Vietnam - Ho Chi Minh
Tel: 84-28-5448-2100

2/27/20



www.microchip.com

Microchip Technology Inc. | 2355 W. Chandler Blvd. | Chandler AZ, 85224-6199

The Microchip name and logo, the Microchip logo, Libero and PolarFire are registered trademarks of Microchip Technology Incorporated in the U.S.A. and other countries. All other trademarks mentioned herein are property of their respective companies.

© 2020, Microchip Technology Incorporated. All Rights Reserved. 9/20

DS00003292B