

LED Driver

LNP-C 20W Series / LNP-□A20WBCA



LNP-C

Highlights & Features

- Constant current design
- Input voltage from 198-264Vac
- Up to 90.5% efficiency
- Independent type
- Meets IEC/EN 61000-3-2, Class C
- Fixed output current
- IP20 assembly for indoor applications

Safety Standards



Model Number:	LNP-□A20WBCA
Unit Weight:	0.09 kg (0.2 lb)
Dimensions (L x W x D):	115 x 45 x 29 mm (4.53 x 1.77 x 1.14 inch)

General Description

Delta LNP-C series of fixed output current LED drivers comes with affordable and reliable features. Compatible with COB and mid-power LEDs from any LED manufacturer. Independent type housing design for stand-alone installations. Various output current selection for different lumen application. Meet major Europe safety certifications and are compliant with EN55015 Immunity/Emissions/Harmonic requirements. The products are designed and rigorously tested to work in various indoor LED lighting conditions.

Model Information

LNP-C LED Driver

Model Number	Input Voltage Range	Rated Output Voltage	Rated Output Current
LNP-03A21WBCA	220-240Vac Typical	42-57Vdc	350mA
LNP-03A20WBCA	198-264Vac Range	31-42Vdc	350mA
LNP-05A20WBCA		31-42Vdc	500mA
LNP-07A20WBCA		21-28.6Vdc	700mA

Model Numbering

LNP -	□A	□W	B	C	A
LED Driver Series P	Output Current 03A – 350mA 05A – 500mA 07A – 700mA	Output Power (20W series model)	Function B – Fixed type	Region C – EMEA & Others	Product Type A – Independent

LED Driver

LNP-C 20W Series / LNP-□A20WBCA

Specifications

Model Number	LNP-03A21WBCA	LNP-03A20WBCA	LNP-05A20WBCA	LNP-07A20WBCA
--------------	---------------	---------------	---------------	---------------

Input Ratings / Characteristics

Normal Input Voltage	220-240Vac			
Input Voltage Range	198-264Vac			
Normal Input Frequency	50/60 Hz			
Input Frequency Range	47-63 Hz			
Normal Input Current	0.12A	0.09A	0.12A	0.12A
Efficiency ¹⁾	230Vac	90.5% typ.	89.5% typ.	89% typ.
No Load Power Consumption	< 0.6W at 230Vac			
Inrush Current (Apk / 50%-us) (Cold Start)	4A/50us @ 230Vac			
Max. no. of LED Driver for Circuit Breaker	90 pcs for MCB (B type 16A 100% Relative number) / (C type 16A 100% Relative number)			
Power Factor	> 0.95 @ 230Vac/50Hz at > 15W load			
Total Harmonic Distortion	< 20% @ 230Vac/50Hz at 100% load			
Leakage Current	< 0.7mA @ 230Vac			

1) 100% Load (typical) and tested after 30 minutes warm up.

Output Ratings / Characteristics

Nominal Output Current	350mA	350mA	500mA	700mA
Output Voltage Range	42-57Vdc	31-42Vdc	31-42Vdc	21-28.6Vdc
Max. No Load Output Voltage	75Vdc	60Vdc	60Vdc	50Vdc
Output Power Range	14.7-20W	10.9-14.7W	15.5-21W	14.7-20W
Output Current Tolerance	± 10%			
Line Regulation	± 5%			
Load Regulation	± 5%			
Output Current Ripple	Low frequency, 50% @max load, 60% @min load (ripple = (pk-avg)/avg)			
Rise Time	< 50ms @ 230Vac			
Start-up Time	< 200ms @ 230Vac			
Hold-up Time	0.5ms typ. @ 230Vac (100% load)			

Mechanical

Casing	Plastic, Color: White, no potting
Dimensions (L x W x D)	115 x 45 x 29 mm (4.53 x 1.77 x 1.14 inch)
Unit Weight	0.09 kg (0.2 lb)
Cooling System	Convection
Input Connector	Terminal, 2-pole (L & N), pin spacing 3.5mm, push-button, 0.75~1.5mm ² , stripping 9-10mm
Output Connector	Terminal, 2-pole (LED+/-), pin spacing 3.5mm, push-button, 0.75~1.5mm ² , stripping 9-10mm

LED Driver

LNP-C 20W Series / LNP-□A20WBCA

Model Number	LNP-03A21WBCA	LNP-03A20WBCA	LNP-05A20WBCA	LNP-07A20WBCA
--------------	---------------	---------------	---------------	---------------

Environment

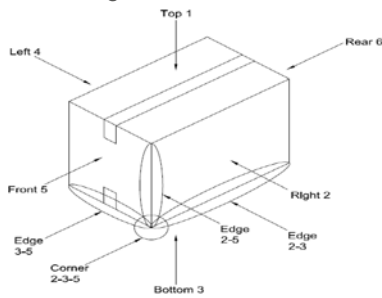
Ambient Temperature	Operating	-25°C to +50°C	-25°C to +55°C	-25°C to +50°C	-25°C to +55°C
	Storage	-25°C to +85°C			
Maximum Case Temperature	+75°C				
Lifetime Case Temperature	+75°C				
Maximum Housing Temperature	+115°C				
Relative Humidity	Operating	10 to 90% RH (Non-Condensing)			
	Storage	5 to 95% RH (Non-Condensing)			
Drop Test	Non-Operating	According to ASTM D-775, 40cm height. Drop to concrete floor as below drawing, total 10 times.			
					
Vibration	Non-Operating	IEC 60068-2-6, Random: 5 Hz to 10 Hz (1G); 30 min per axis for all X, Y, Z direction			

Protections

Over Voltage	58-75Vdc	43-60Vdc	43-60Vdc	29-50Vdc
Open Load	Auto-Recovery when the fault is removed			
Short Circuit	Auto-Recovery when the fault is removed			
Over Temperature	N/A			
Ingress Protection Classification	20			
Suitable for Luminaires Class	Class II. Insulation Class according to IEC 60598			

Reliability Data

Lifetime	50,000 hrs. at lifetime case temperature
MTBF	500,000 hrs. as per Telcordia SR-332 (ta: +50°C)

Safety Standards / Directives

Electrical Safety	CB scheme ENEC SELV	IEC 61347-1, IEC 61347-2-13 EN 61347-1, EN 61347-2-13, EN 62384 SELV
CE	In conformance with EMC Directive 2014/30/EU and Low Voltage Directive 2014/35/EU	
Material and Parts	RoHS Directive 2011/65/EU Compliant	
Galvanic Isolation	Input to Output	3.75kVac

LED Driver

LNP-C 20W Series / LNP-□A20WBCA

Model Number	LNP-03A21WBCA	LNP-03A20WBCA	LNP-05A20WBCA	LNP-07A20WBCA
--------------	---------------	---------------	---------------	---------------

EMC

Emissions (CE & RE)	Compliance to EN 55015:2013 Class B	
Immunity	Compliance to EN 61547:2009	
Electrostatic Discharge	IEC 61000-4-2:2008 Ed.2.0	ESD, Criteria A ¹⁾ or B ²⁾ Air Discharge: 8kV; Contact Discharge: 4kV
Radiated Field	IEC 61000-4-3:2010 Ed.3.2	RS, Criteria A1 80MHz-1GHz, 3V/m with 1kHz Sine Wave / 80% AM Modulation
Electrical Fast Transient / Burst	IEC 61000-4-4:2012-Ed.3.0	EFT, Criteria A ¹⁾ or B ²⁾ 1kV
Surge	IEC 61000-4-5:2014 Ed.3.0	Criteria A ¹⁾ or B ²⁾ Common Mode ³⁾ :1kV; Differential Mode ⁴⁾ :0.5kV 1.2/50µs, 8/20µs Combination Wave with 2ohms (L-N), 12ohms (L-PE & N-PE) source impedance
Conducted	IEC 61000-4-6:2013 Ed.4.0	CS, Criteria A ¹⁾ 150kHz-80MHz, 3Vrms
Power Frequency Magnetic Fields	IEC 61000-4-8:2009 Ed.2.0	PFMF, Criteria A ¹⁾ 3A/Meter
Voltage Dips	IEC 61000-4-11:2004 Ed.2.0	Criteria A ¹⁾ or B ²⁾ ; 100% dip; 0.5 cycle; Self Recoverable 30% dip; 10 cycle; Self Recoverable
Harmonic Current Emission	IEC 61000-3-2:2014	Class C (230Vac @ 100% load)
Voltage Fluctuation & Flicker	IEC 61000-3-3:2013	

1) Criteria A: Normal performance within the specification limits
2) Criteria B: Temporary degradation or loss of function which is self-recoverable

3) Asymmetrical: Common mode (Line to earth)
4) Symmetrical: Differential mode (Line to line)

Lifetime VS Case Temperature

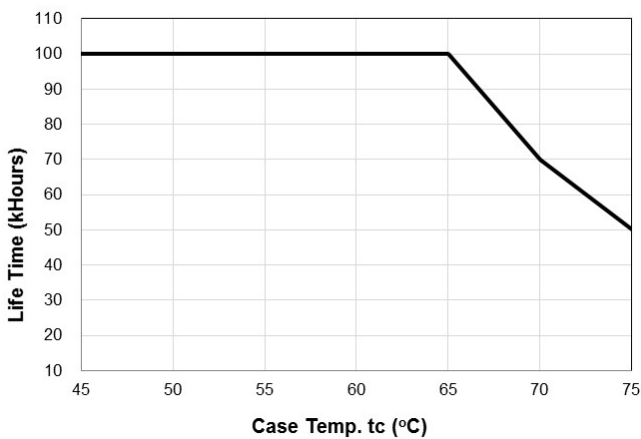

Lifetime VS Ambient Temperature

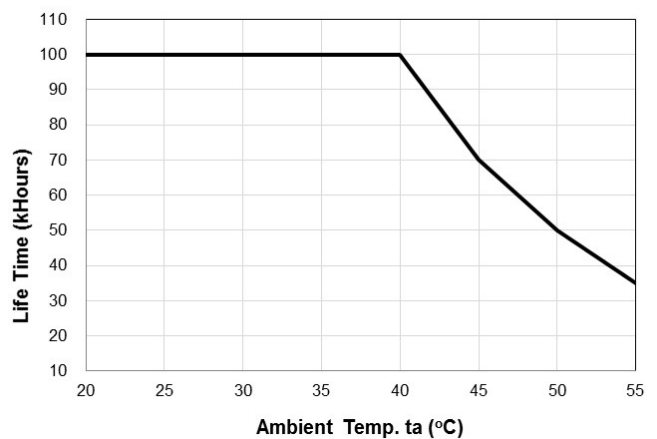

LED Driver

LNP-C 20W Series / LNP-□A20WBCA

Efficiency VS Output Power

LNP-03A21WBCA – 350mA

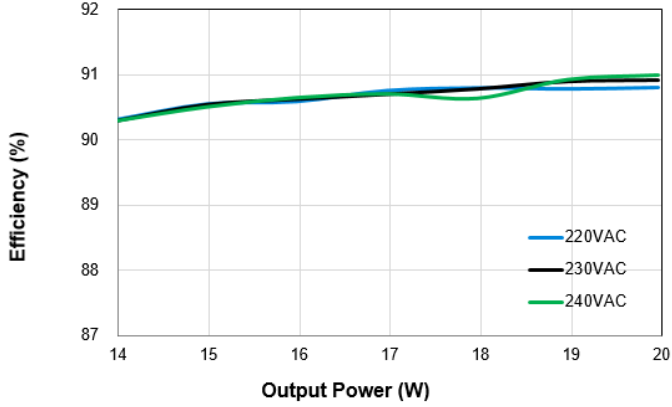

LNP-03A20WBCA – 350mA

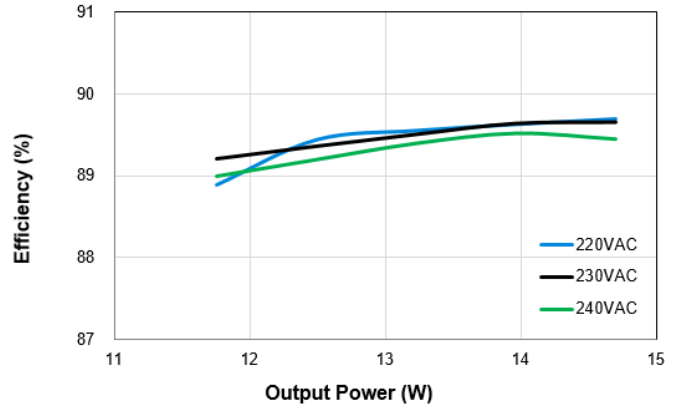

LNP-05A20WBCA – 500mA

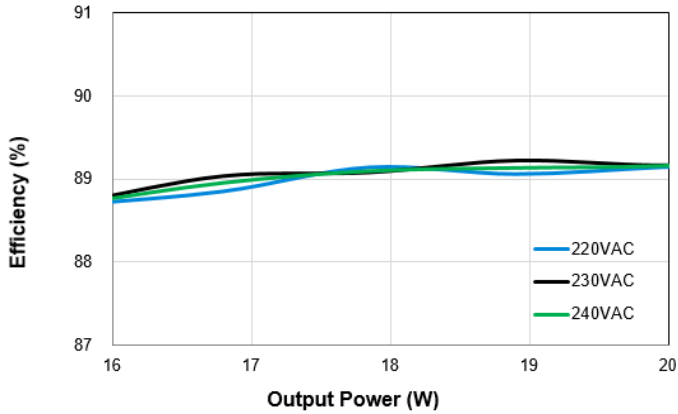

LNP-07A20WBCA – 700mA

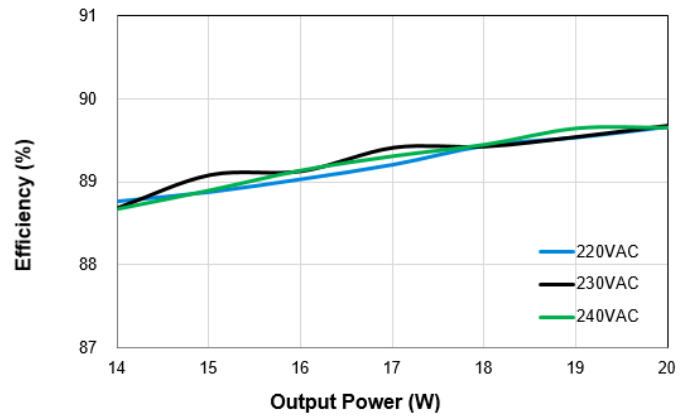

LED Driver

LNP-C 20W Series / LNP-□A20WBCA

Power Factor VS Output Power

LNP-03A21WBCA – 350mA

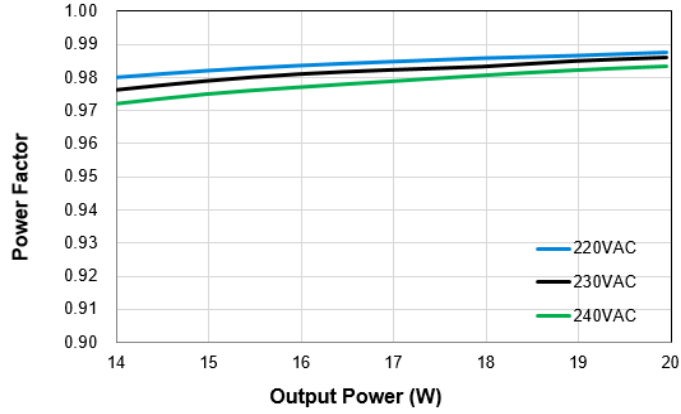

LNP-03A20WBCA – 350mA

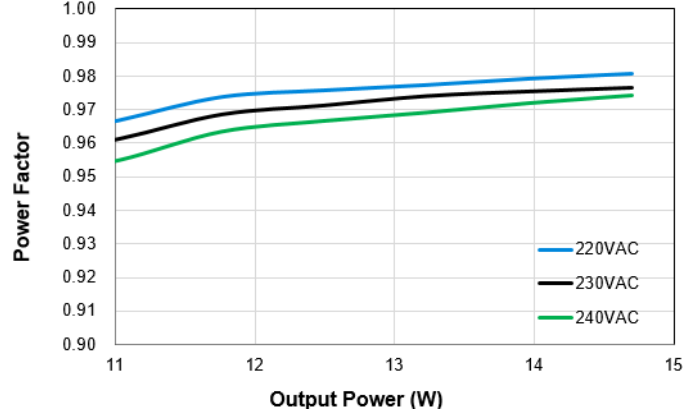

LNP-05A20WBCA – 500mA

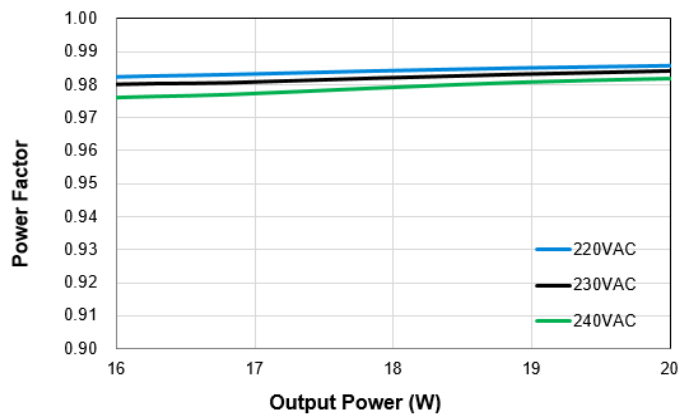

LNP-07A20WBCA – 700mA

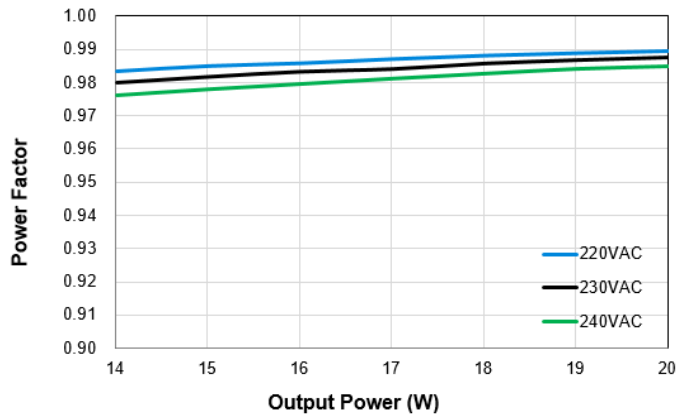

LED Driver

LNP-C 20W Series / LNP-□A20WBCA

Total Harmonic Distortion VS Output Power

LNP-03A21WBCA – 350mA

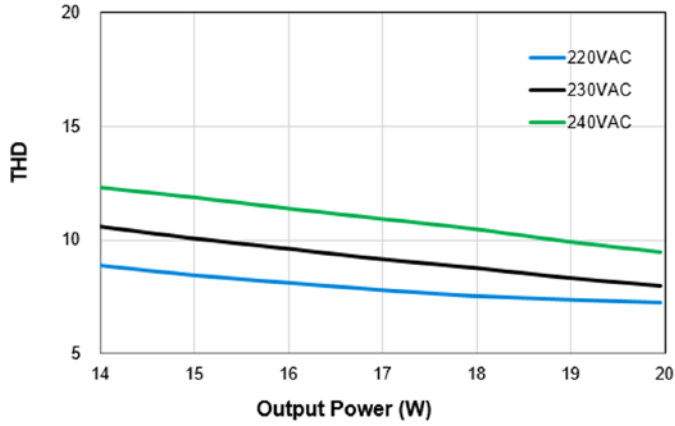

LNP-03A20WBCA – 350mA

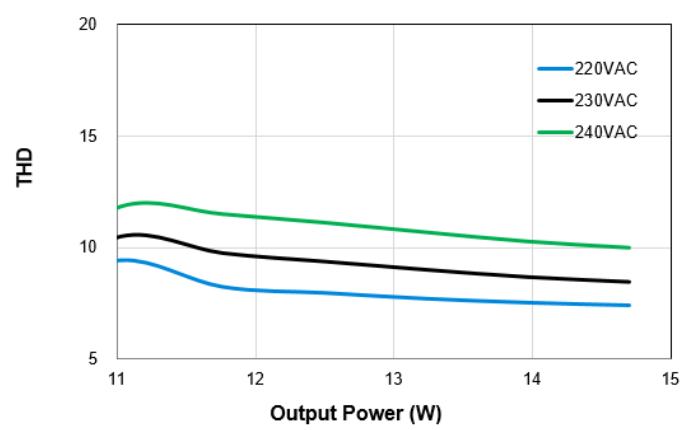

LNP-05A20WBCA – 500mA

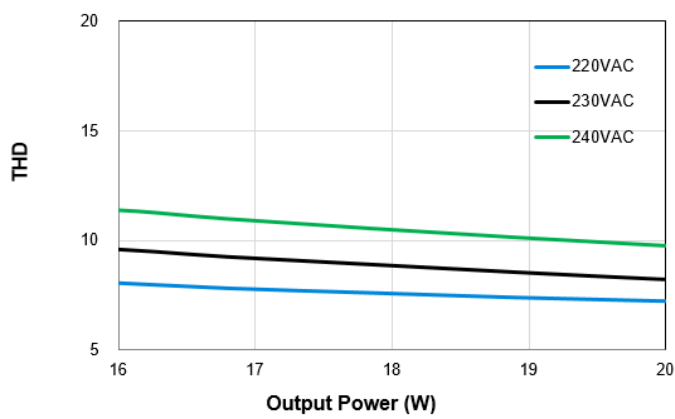

LNP-07A20WBCA – 700mA

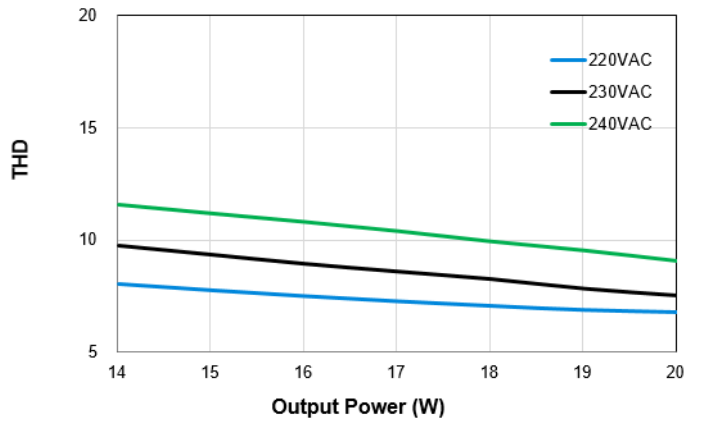

LED Driver

LNP-C 20W Series / LNP-□A20WBCA

Dimensions

L x W x D: 115 x 45 x 29 mm (4.53 x 1.77 x 1.14 inch)

Independent Type

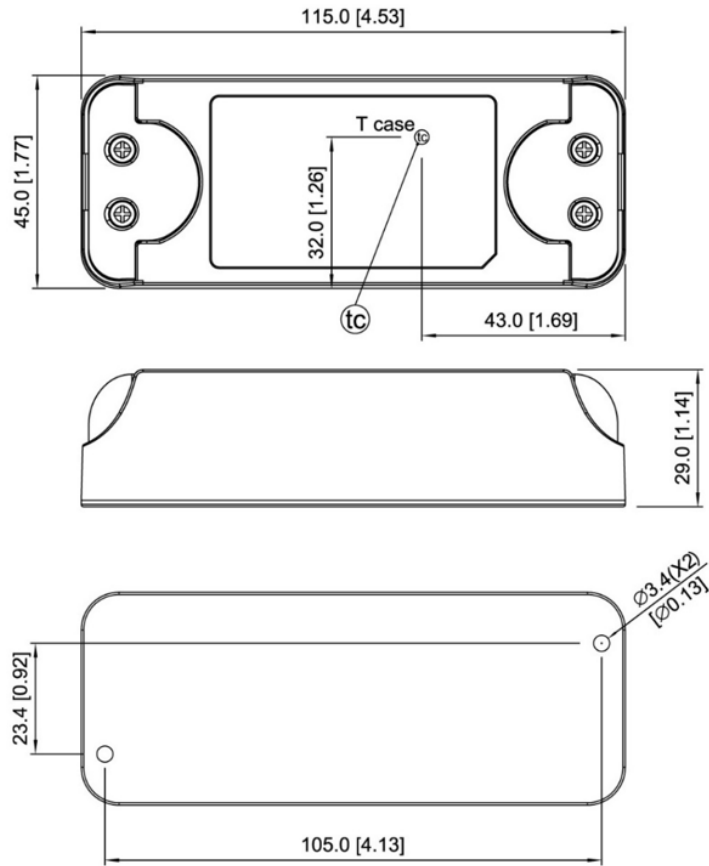

Wiring Connection

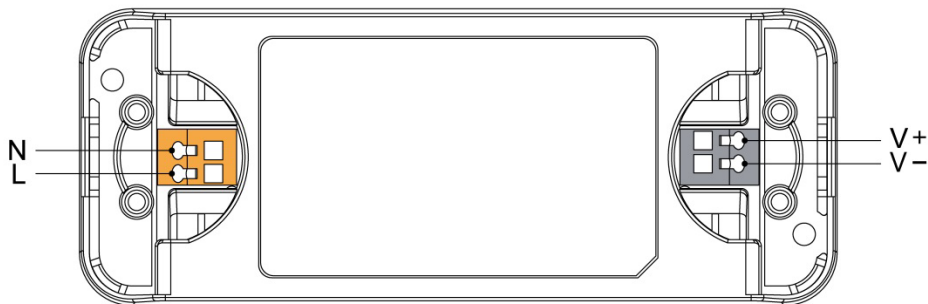

LED Driver

LNP-C 20W Series / LNP-□A20WBCA

Assembly & Installation

Mounting holes for LED driver assembly onto the mounting surface.

- | | |
|-------------|--|
| <p>Ⓐ, Ⓑ</p> | <p>Mounting holes for the LED driver (device). There are 1 mounting holes at either end of the device (locations Ⓐ and Ⓑ in Fig.1). The device shall be mounted using 1 mounting hole on both sides. Mounting shall be done using M3 screws with minimum length of 4mm. If customer's end system or panel where the device is mounted does not have screw threads, please use suitable metal screw and nut to secure the device.</p> |
| <p>Ⓒ</p> | <p>Surface Ⓒ belongs to customer's end product or panel where the device is mounted. The device should be mounted on a sturdy heat conducting surface with minimum of 2 mounting holes, as detailed above.</p> |

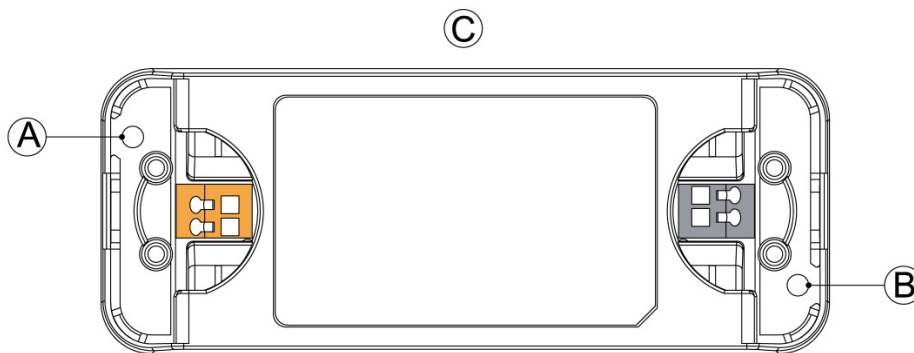

Fig. 1 Mounting Hole Locations

Safety Instructions

- ALWAYS switch mains of input power OFF before connecting and disconnecting the input voltage to the device. If mains are not turned OFF, there is risk of explosion / severe damage.
- To guarantee sufficient convection cooling, keep a distance of 50mm above and lateral distance to nearby objects.
- The device is not recommended to be placed on low thermal conductive surfaces. For example, plastics.
- DO NOT insert any objects into the device.
- Note that the enclosure of the device can become very hot depending on the surrounding air temperature and output load connected to the device. Risk of burns!
- The current rating for the all wires, connected to the input and output wires of the device, must be rated higher than or equal to the input and output current of the power supply. Please refer to the product specifications.
- For device with dimming function, always ensure the dimming control is working properly.
- Please ensure the correct tools are used for all adjustments and installations of the device. If in doubt, please consult your local Delta support or contact us via info@DeltaPSU.com.

LED Driver

LNP-C 20W Series / LNP-□A20WBCA

Functions

Start-up Time

The time required for the output voltage to reach 90% of its final steady state set value, after the input voltage is applied.

Rise Time

The time required for the output voltage to change from 10% to 90% of its final steady state set value.

Hold-up Time

Time between the collapse of the AC input voltage, and the output falling to 95% of its steady state set value.

■ Graph illustrating the Start-up Time, Rise Time, and Hold-up Time

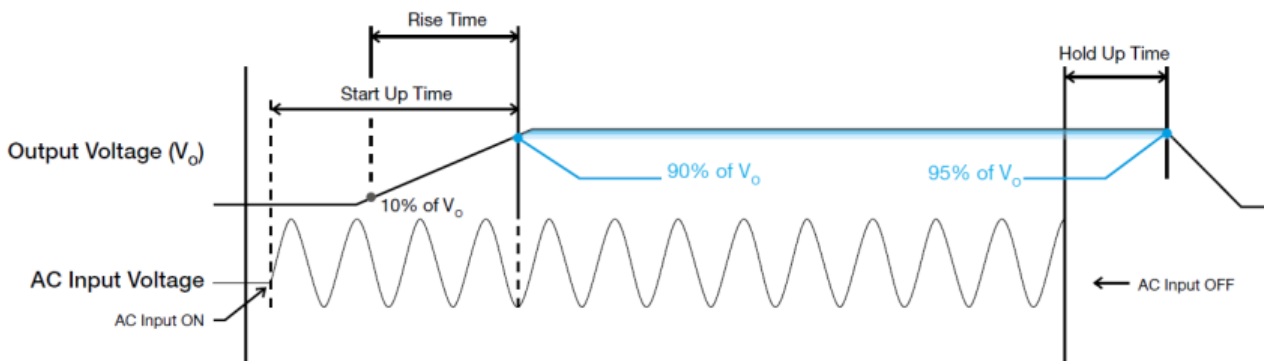

Inrush Current

Inrush current is the peak, instantaneous, input current measured and, occurs when the input voltage is first applied. For AC input voltages, the maximum peak value of inrush current will occur during the first half cycle of the applied AC voltage. This peak value decreases exponentially during subsequent cycles of AC voltage.

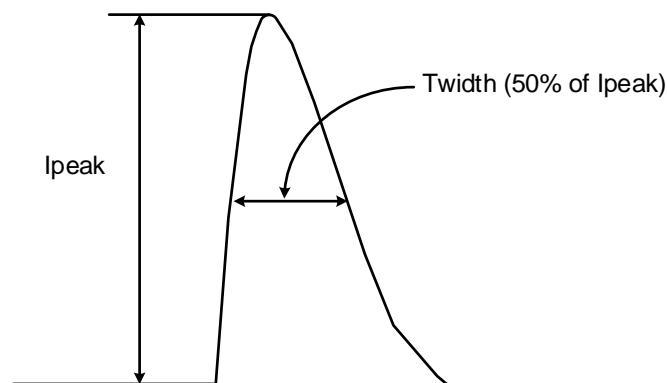

LED Driver

LNP-C 20W Series / LNP-□A20WBCA

Operating Methods of LED Modules-CV and CC Operation

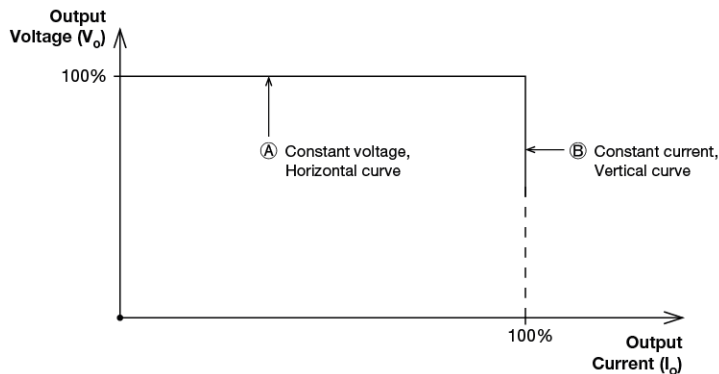

A typical LED power supply is able to either work in "constant voltage mode (CV) or constant current mode (CC)" to drive the LEDs. Delta's LED drivers integrate CV+CC characteristics; so operation in CV mode (with external LED driver), in region (A) or CC mode (direct drive, at area (B)).

In the constant current region, the highest voltage at the output of the driver depends on the configuration of the end systems.

Should there be any compatibility issues or other questions with these adjustment methods, please contact with Delta.

Over Voltage Protections (Auto-Recovery)

The LED driver's Overvoltage Protections (OVP) will be activated when output voltage is achieved trigger point defined at OVP range. Upon such an occurrence, the I_o (output current) will start to droop.

Short Circuit Protection (Auto-Recovery)

The LED driver's output OLP function also provides protection against short circuits. When a short circuit is applied, the LED driver will operate in "hiccup mode". It will return to normal operation after the short circuit is removed.

Overload & Overcurrent Protection (Auto-Recovery)

The power supply's Overload (OLP) and Overcurrent (OCP) Protections will be activated when output is between 95% and 108% of I_o (max load). Upon such an occurrence, the V_o (output voltage) will start to droop. Once the power supply has reached its maximum power limit, the protection will be activated; and, the power supply will operate in "CC mode". The power supply will recover once the fault condition once the cause of OLP or OCP is removed, and I_o is back within the specified range.

Others

Delta RoHS Compliant



Restriction of the usage of hazardous substances

The European directive 2011/65/EU limits the maximum impurity level of homogeneous materials such as lead, mercury, cadmium, chrome, polybrominated flame retardants PBB and PBDE for the use in electrical and electronic equipment. RoHS is the abbreviation for "Restriction of the use of certain hazardous substances in electrical and electronic equipment".

This product conforms to this standard.

PFC – Norm EN 61000-3-2



Line Current Harmonic content

Typically, the input current waveform is not sinusoidal due to the periodical peak charging of the input capacitor. In industrial environment, complying with EN 61000-3-2 is only necessary under special conditions. Complying with this standard can have some technical drawbacks, such as lower efficiency as well as some commercial aspects such as higher purchasing costs. Frequently, the user does not profit from fulfilling this standard, therefore, it is important to know whether it is mandatory to meet this standard for a specific application.