

# Circular Connectors for Audio Equipment

## HA Series

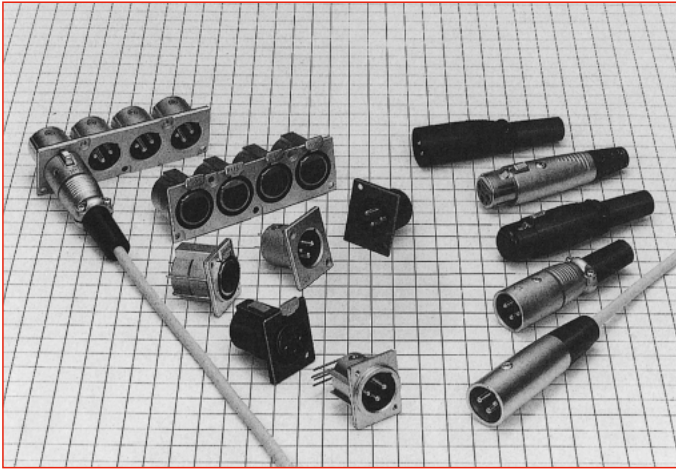

### ■ Features

#### 1. Circular connectors with lock mechanism for audio equipment

Additional grounding feature prevents external noise.

This series includes four different receptacle sizes and two types of cable clamping mechanisms used on the plugs. Receptacle selection will depend on your particular design and available mounting space.

### ■ Product Specifications

	No. of contacts	Rated voltage	Rated current	Operation temperature range	Storage temperature range
Ratings	3	AC130V, DC180V	15A 3 A (PCB dip type)	-25 to +70°C	-10 to +60°C
	4		5A		
	5		4A		

Items	Specifications	Conditions
1. Contact resistance	3 and 4 contacts: 5 mΩ max. 3 contacts (PCB dip type), 5 contacts: 10 mΩ min.	Measured at DC 1 A
2. Insulation resistance	1,000 MΩ min.	Measured at DC 500 V
3. Withstanding voltage	No flashover or dielectric breakdown.	AC 1,400 V for one minute
4. Vibration resistance	No electrical discontinuity for 10 μs or greater	10 to 55 Hz/cycle, amplitude: 0.75 mm, in 3 axis directions, for 2 hours each direction
5. Shock resistance	No electrical discontinuity for 10 μs or greater	Acceleration: 490 m/s <sup>2</sup> , duration: 11 ms, 3 axis directions, 3 cycles each direction
6. Mating Cycles	3 and 4 contacts: a maximum of 10 mΩ 3 contacts (PCB dip style) 5 contacts: 20 mΩ max.	1,000 times
7. Temperature cycle	Insulation resistance: 1,000 MΩ max.	-55°C: 30 minutes → Normal temperature: 10 to 15 minutes → 85°C: 30 minutes → Normal temperature: 10 to 15 minutes, left for 5 cycles
8. Moisture resistance	Insulation resistance: 10 MΩ (at high humidity) min. 100 MΩ (when dry) min.	Temperature: 40°C, relative humidity: 90 to 95%, left for 96 hours

### ■ Materials

Parts	Material	Finish	Remarks
Shell	Aluminum alloy or zinc alloy	Matte finished, nickel plating	—————
Insulator	Polyamide resin or PBT resin	—————	UL94V-0
Contact	Copper alloy	Silver plating	—————

## ■ Ordering information

### ● Plug and receptacle

**HA 16 PR N - 3 S F - A (\*\*)**

① ② ③ ④ ⑤ ⑥ ⑦ ⑧ ⑨

① Model name: HA Series
② Shell size: Shell size is the outer diameter of the mating interface of the plug.
③ Connector shape: P: Plug R: Receptacle PR: Plug receptacle J: Jack
④ Shell variation: A, B, C, etc. is used to note exterior shell changes.
⑤ Number of contacts
⑥ Contact form: P: Male contact S: Female contact
⑦ Contact termination method or shape: A, B, C, etc. is used to note any changes to the termination method or type.
⑧ Gang type: Notes a ganged arrangement of receptacles.
⑨ Other specifications: A two-digit number is added to indicate other specifications.

■ Plug

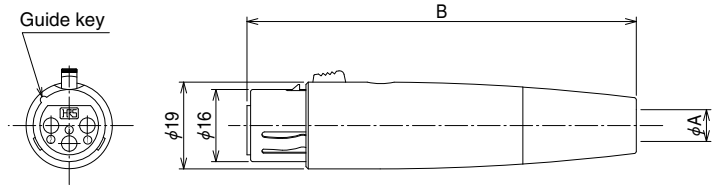

(Representative example)

HRS No.	Part No.	No. of contacts	φA	B	Weight	Remarks
104-0359-0 71	HA16PA-3S(71)	3	4.5	86	50 g	—
104-0426-6 71	HA16PK-4S(71)	4	6	78		—

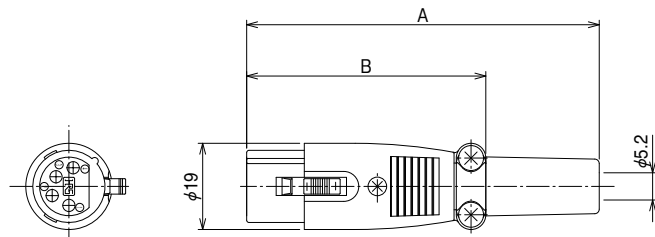

(Representative example)

HRS No.	Part No.	No. of contacts	A	B	Weight	Remarks
104-0701-9 71	HA216P-3S(71)	3	78.5	53.5	40 g	—
104-0702-1 71	HA216P-4S(71)	4	77.7	52.7		—
104-0703-4 71	HA216P-5S(71)	5	78.5	53.5		—

■ Jack

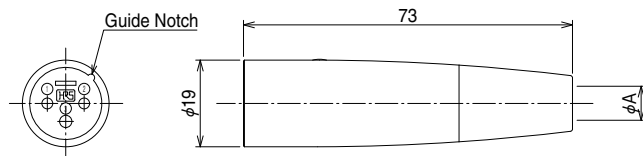

(Representative example)

HRS No.	Part No.	No. of contacts	φA	Weight	Remarks
104-0358-8 76	HA16JA-3P(76)	3	4.5	40 g	—

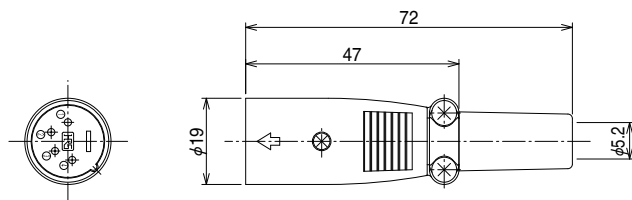

(Representative example)

HRS No.	Part No.	No. of contacts	Weight	Remarks
104-0704-7 76	HA216J-3P(76)	3	40 g	—
104-0705-0 76	HA216J-4P(76)	4		—
104-0706-2 76	HA216J-5P(76)	5		—

**■ Receptacle (Solder Type)**  
**(Large Flange Type)**

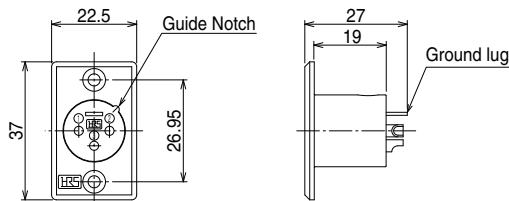

(Representative example)

HRS No.	Part No.	No. of contacts	Weight	Remarks
104-0349-7 76	HA16R-3P(76)	3	13 g	—

**(Medium Flange Type)**

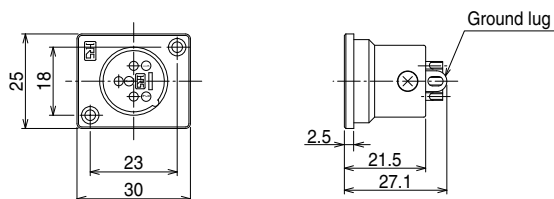

(Representative example)

HRS No.	Part No.	No. of contacts	Weight	Remarks
104-0393-9 76	HA16RD-3P(76)	3	14 g	—
104-0402-8 76	HA16RD-4P(76)	4		—

**(Small Flange Type)**

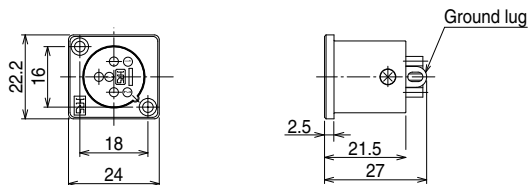

(Representative example)

HRS No.	Part No.	No. of contacts	Weight	Remarks
104-0382-2 76	HA16RA-3P(76)	3	11 g	—
104-0408-4 76	HA16RA-4P(76)	4		—
104-0383-5 76	HA16RA-5P(76)	5		—

**■ Receptacle (Solder Type)**  
**(Inside Mount Type)**

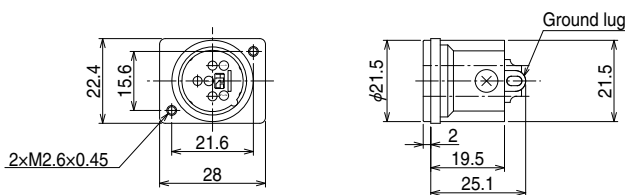

HRS No.	Part No.	No. of contacts	Weight	Remarks
104-0431-6 76	HA16RM-3P(76)	3	14 g	—

Mar.1.2018 Copyright 2018 HIROSE ELECTRIC CO., LTD. All Rights Reserved.

### ■ Receptacle (PCB Through Hole Type)

(Inside Mount Type, Straight Dip)

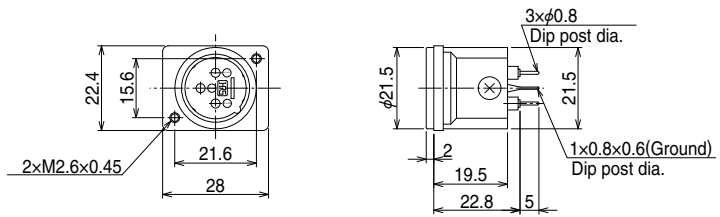

(Representative example)

HRS No.	Part No.	No. of contacts	Weight	Remarks
104-0420-0 76	HA16RM-3PE(76)	3	14g	—

(Inside Mount Type, Right Angle Dip)

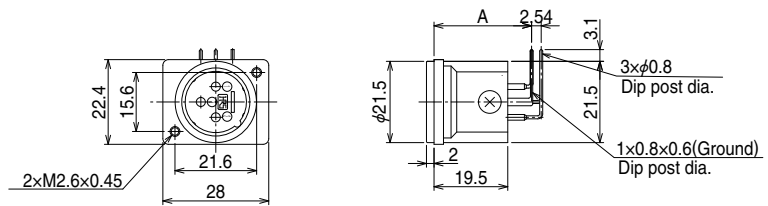

(The above shapes are examples. The left bent type is shown in this figure.)

HRS No.	Part No.	No. of contacts	A	Weight	Remarks
104-0416-2 76	HA16RM-3PB(76)	3	23.2	14 g	Dip post down bent
104-0418-8 76	HA16RM-3PD(76)		25.8		Dip post left bent

### ■ Plug-Receptacle (Solder Type)

(Small Flange Type)

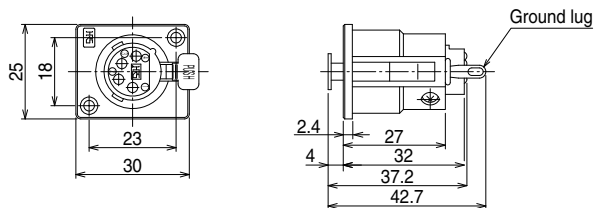

(Representative example)

HRS No.	Part No.	No. of contacts	Weight	Remarks
104-0395-4	HA16PRH-3S	3	26 g	Without ground lug
104-0403-0	HA16PRH-4S	4		
104-0404-3	HA16PRH-5S	5		
104-0411-9	HA16PRK-3S	3		With ground lug
104-0427-9	HA16PRK-4S	4		

### ■ Plug-Receptacle (Solder Type)

(Inside Mount Type)

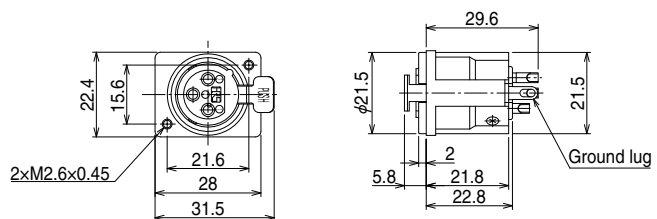

(Representative example)

HRS No.	Part No.	No. of contacts	Weight	Remarks
104-0432-9 05	HA16PRM-3S(05)	3	18 g	—

**Plug-Receptacle (PCB Through Hole Type)**  
**(Inside Mount Type, Straight Dip)**

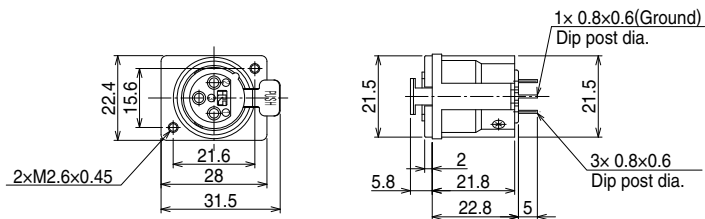

HRS No.	Part No.	No. of contacts	Weight	Remarks
104-0421-2 71	HA16PRM-3SE(71)	3	18 g	—

**(Inside Mount Type, Right Angle Dip)**

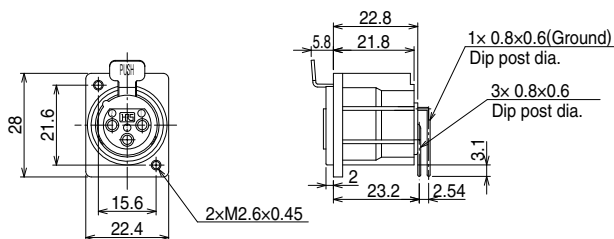

HRS No.	Part No.	No. of contacts	Weight	Remarks
104-0417-5 71	HA16PRM-3SB(71)	3	18 g	Dip post down bent

**Gang Type**  
**(Plug-Receptacle Solder Type)**

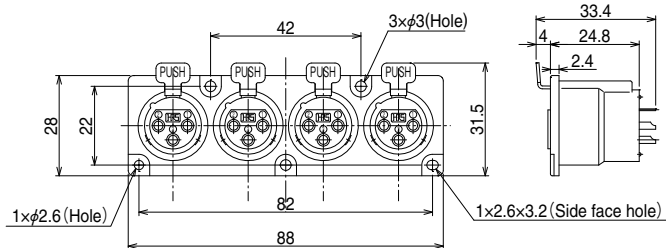

HRS No.	Part No.	No. of contacts	Weight	Remarks
104-0423-8 71	HA16PRN-3SF-A(71)	3	80 g	4 chain type

Mar.1.2018 Copyright 2018 HIROSE ELECTRIC CO., LTD. All Rights Reserved.

**(Plug-Receptacle PCB Through Hole Type)**

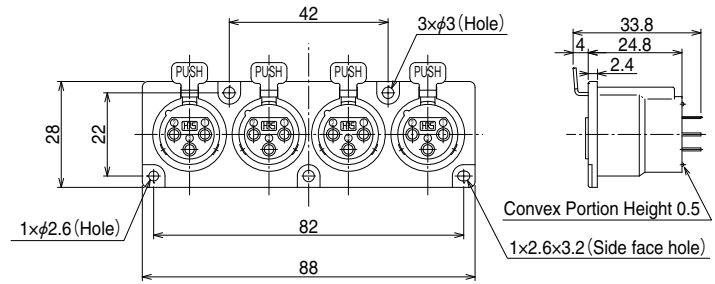

HRS No.	Part No.	No. of contacts	Weight	Remarks
104-0441-0 71	HA16PRN-3SE-A(71)	3	68gr	4 chain type

**Dip post down bent type**

**◆ Panel Cutout**

○ Receptacle

**(Large Flange Type)**

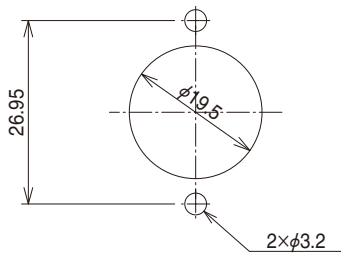

**(Middle Flange Type)**

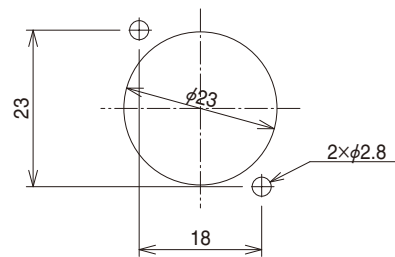

**(Small Flange Type)**

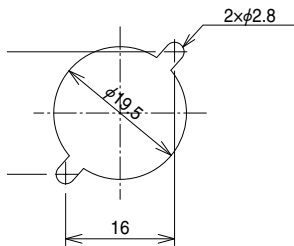

● HA16RM

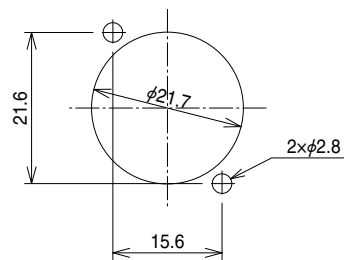

○ Plug Receptacle Type

**(Small Flange Type)**

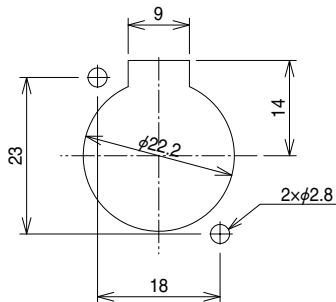

**(Inside Mount Type)**

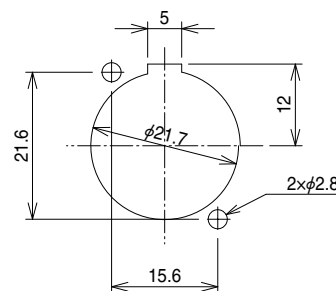

● HA16PRM

◆ Panel Cutout

○ Gang Type  
(Plug-Receptacle)

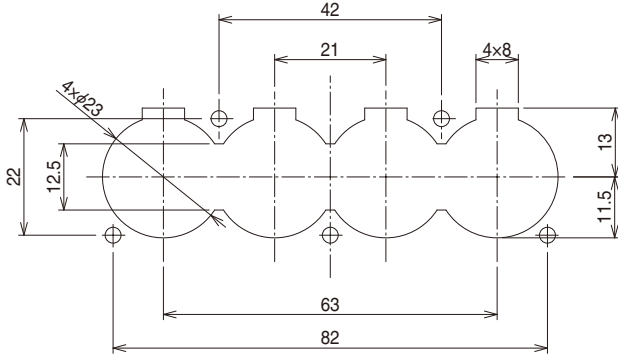

◆ Receptacle Dip Post Layout

(The figure below shows the board surface in which connector terminal dip posts are to be inserted.)

○ Dip post down bent type

● HA16RM-3PB(76)

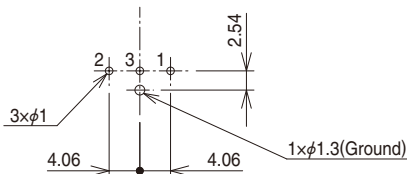

○ Dip post left bent type

● HA16RM-3PD(76)

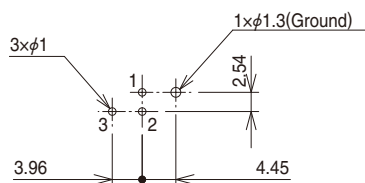

○ Dip post straight type

(As viewed from the mating surface)

● HA16RM-3PE(76)

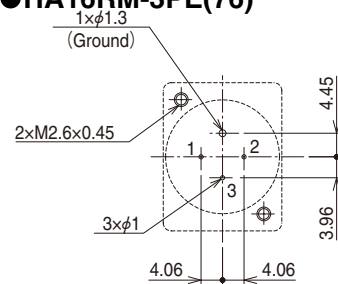

◆ Plug-Receptacle Dip Post Layout

(The figure below shows the board surface in which connector terminal dip posts are to be inserted.)

○ Dip post down bent type

HA16PRM-3SB(71)

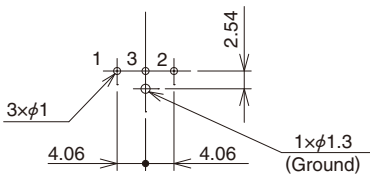

○ Dip post straight type

(As viewed from the mating surface)

● HA16PRM-3SE(71)

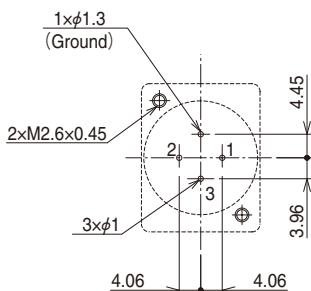

● HA16PRN-3SE-A(71)

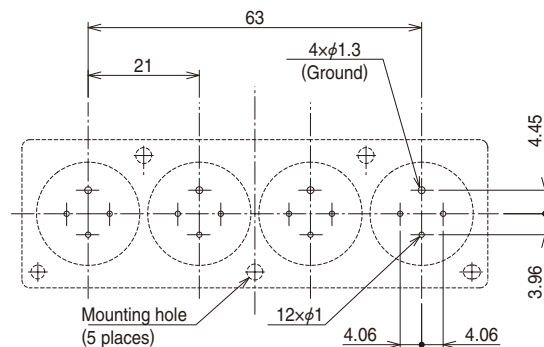



## ◆ Coupling Combination

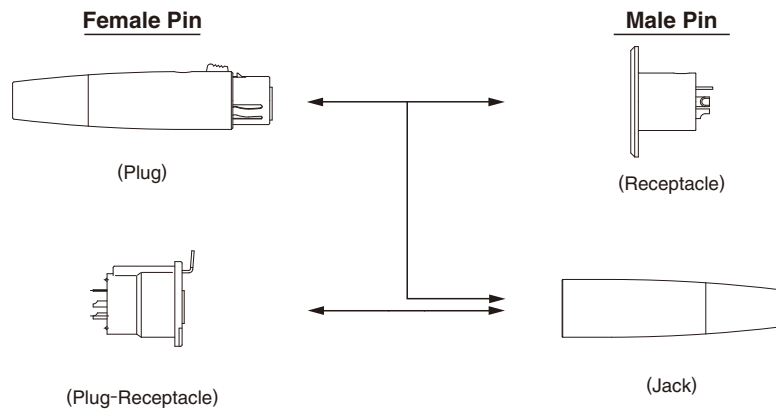

## ◆ Termination procedure

### ● Plug side (HA16 type, jack side connector follows the same assembly procedure)

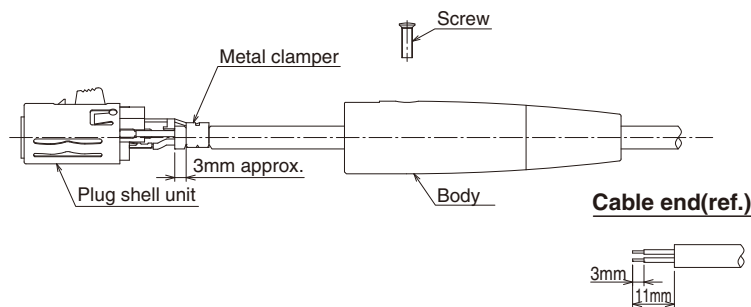

## ○ Operation procedure

1. Please choose a cable of which the outside diameter is 4-6mm.
2. Strip insulation of the cable end in the size as shown above.
3. Solder the cable to plug shell.
4. Crimp cable clamper, which holds cable, with a tool.
5. Fit the P shell unit to the cord tube, and tighten the locking screw with a Torque of 0.3-0.4N·m(3.5-4kg·cm) to complete the work.

For details, contact our sales or engineering department before using the model HA16 plugs.

### ● Receptacle side

## ○ Precautions

If heat shrink tubing is applied to the solder terminating section for insulation purposes, overheating could reduce the torque of the screw tightness.

Such overheating may result in loosening and possible loss of the screw. It is advised to confirm that a minimum torque of at least 0.1 N·m is obtained after termination.

If a torque of at least 0.1 N·m is not realized, the screw should be tightened to between 0.3 and 0.4 N·m.

For details on usage, please contact our Sales or Engineering Department.

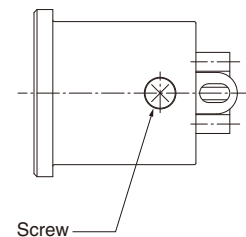

## ◆ Terminal arrangement and major specifications

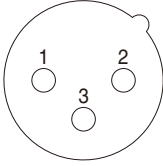
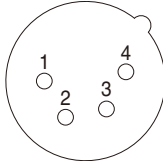
Terminal arrangement			
No. of contacts	3		4
Withstanding voltage	AC1,400V a minute		AC1,400V a minute
Current rating	15A	3A(Board dip type)	5A
Insulation resistance	1,000MΩ MIN.		1,000 MΩ MIN.
Contact resistance	5 mΩ MAX.	10 mΩ MAX.	5 mΩ MAX.

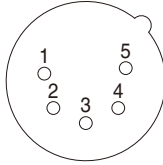
Terminal arrangement	
No. of contacts	5
Withstanding voltage	AC1,400V a minute
Current rating	4A
Insulation resistance	1,000 MΩ MIN.
Contact resistance	10 mΩ MAX.

Note 1. The above figures show the receptacle as viewed from the mating side.

2. The withstand voltages show test voltages.

3. The insulation resistances show the values at 500V DC.

4. The contact resistance show the values at 1A DC.



**USA:**

**HIROSE ELECTRIC (U.S.A.), INC. HEADQUARTERS**  
 2688 Westhills Court, Simi Valley, CA 93065-6235  
 Phone : +1-805-522-7958  
 Fax : +1-805-522-3217  
<http://www.hirose.com/us/>

**USA:**

**HIROSE ELECTRIC (U.S.A.), INC. SAN JOSE OFFICE**  
 3255 Scott Boulevard, Building 7, Suite 101  
 Santa Clara, CA 95054  
 Phone : +1-408-253-9640  
 Fax : +1-408-253-9641  
<http://www.hirose.com/us/>

**USA:**

**HIROSE ELECTRIC (U.S.A.), INC. CHICAGO OFFICE**  
 580 Waters Edge Lane, Suite 205 Lombard IL  
 60148  
 Phone : +1-630-282-6706  
 Mail : [inquiries@hirose.com](mailto:inquiries@hirose.com)  
<http://www.hirose.com/us/>

**USA:**

**HIROSE ELECTRIC (U.S.A.), INC. DETROIT OFFICE (AUTOMOTIVE)**  
 37677 Professional Center Drive, Suite #100C  
 Livonia, MI 48154  
 Phone : +1-734-542-9963  
 Fax : +1-734-542-9964  
<http://www.hirose.com/us/>

**THE NETHERLANDS:**

**HIROSE ELECTRIC EUROPE B.V.**  
 Hogehillweg #8 1101 CC Amsterdam Z-0  
 Phone : +31-20-6557460  
 Fax : +31-20-6557469  
<http://www.hirose.com/eu/>

**GERMANY:**

**HIROSE ELECTRIC EUROPE B.V. GERMAN BRANCH**  
 Herzog-Carl-Strasse 4 D-73760 Ostfildern  
 (Scharnhäuser Park)  
 Phone : +49-711-4560-02-1  
 Fax : +49-711-4560-02-299  
<http://www.hirose.com/eu/>

**GERMANY:**

**HIROSE ELECTRIC EUROPE B.V. NUERNBERG OFFICE**  
 Muggenhofer Str. 136 90429 Nuernberg  
 Phone : +49-911 32 68 89 63  
 Fax : +49-911 32 68 89 69  
<http://www.hirose.com/eu/>

**UNITED KINGDOM:**

**HIROSE ELECTRIC EUROPE BV (UK BRANCH)**  
 4 Newton Court, Kelvin Drive, Knowlhill,  
 Milton Keynes, MK5 8NH  
 Phone : +44-1908 202050  
 Fax : +44-1908 202058  
<http://www.hirose.com/eu/>

**CHINA:**

**HIROSE ELECTRIC (SHANGHAI) CO., LTD.**  
 1601, Henderson Metropolitan, NO.300, East Nanjing  
 Road, Huangpu District, Shanghai, China 200001  
 Phone : +86-21-6391-3355  
 Fax : +86-21-6391-3335  
<http://www.hirose.com/cn/>

**CHINA:**

**HIROSE ELECTRIC (SHANGHAI) CO.,LTD. BEIJING BRANCH**  
 A1001, Ocean International Center, Building 56# East 4th  
 Ring Middle Road, ChaoYang District, Beijing, 100025  
 Phone : +86-10-5165-9332  
 Fax : +86-10-5908-1381  
<http://www.hirose.com/cn/>

**CHINA:**

**HIROSE ELECTRIC TECHNOLOGIES (SHENZHEN) CO., LTD.**  
 Room 09-13, 19/F, Office Tower Shun Hing Square, Di Wang Commercial Centre,  
 5002 Shen Nan Dong Road, Shenzhen City, Guangdong Province, 518008  
 Phone : +86-755-8207-0851  
 Fax : +86-755-8207-0873  
<http://www.hirose.com/cn/>

**HONG KONG:**

**HIROSE ELECTRIC HONGKONG TRADING CO., LTD.**  
 Room 1001, West Wing, Tsim Sha Tsui Centre, 66  
 Mody Road, Tsim Sha Tsui East, Kowloon, Hong Kong  
 Phone : +852-2803-5338  
 Fax : +852-2591-6560  
<http://www.hirose.com/hk/>

**TAIWAN:**

**HIROSE ELECTRIC TAIWAN CO., LTD.**  
 103 8F, No.87, Zhengzhou Rd., Taipei  
 Phone : +886-2-2555-7377  
 Fax : +886-2-2555-7350  
<http://www.hirose.com/cn/>

**KOREA:**

**HIROSE KOREA CO., LTD.**  
 1261-10, Jeoungwhang-Dong, Shihung-City,  
 Kyunggi-Do 429-450  
 Phone : +82-31-496-7000,7124  
 Fax : +82-31-496-7100  
<http://www.hirose.co.kr/>

**SINGAPORE:**

**HIROSE ELECTRIC SINGAPORE PTE. LTD.**  
 10 Anson Road #26-1, International Plaza  
 079903, Singapore  
 Phone : +65-6324-6113  
 Fax : +65-6324-6123  
<http://www.hirose.com/sg/>

**INDIA:**

**HIROSE ELECTRIC SINGAPORE PTE. LTD. DELHI LIAISON OFFICE**  
 Office NO.519, Regus-Green Boulevard, Level5, Tower C,  
 Sec62, Plot B-9A, Block B, Noida, 201301, Uttar Pradesh, India  
 Phone : +91-12-660-8018  
 Fax : +91-120-4804949  
<http://www.hirose.com/sg/>

**INDIA:**

**HIROSE ELECTRIC SINGAPORE PTE. LTD. BANGALORE LIAISON OFFICE**  
 Unit No.03, Ground Floor, Explorer Building International Tech  
 Park Whitefield Road, Bangalore 560066 Karnataka, India  
 Phone : +91-80-4120 1907  
 Fax : +91-80-4120 9908  
<http://www.hirose.com/sg/>

**MALAYSIA:**

**HIROSE ELECTRIC SINGAPORE PTE. LTD. (REPRESENTATIVE OFFICE)**  
 1-10-07, Suntech @ Penang Cybercity (1164),Lintang  
 Mayang Pasir 3,11950, Bayan Baru, Penang, Malaysia.  
 Phone : +604-619-2564  
 Fax : +604-619-2574  
<http://www.hirose.com/sg/>



**HIROSE ELECTRIC CO.,LTD.**

2-6-3,Nakagawa Chuoh,Tsuzuki-Ku,Yokohama-Shi 224-8540,JAPAN  
 TEL: +81-45-620-3526 Fax: +81-45-591-3726  
<http://www.hirose.com>  
<http://www.hirose-connectors.com>