

POWER RELAY

1 POLE – 5A Slim Power Relay

FTR-MY Series

■ FEATURES

- Width 5mm, height 12mm (31% smaller than NY series) area 100 mm², super slim , low power, compact and light weight 2.5gr.
- Nominal power: 110mW (8% less than NY series), Operate power: 54mW
High sensitive
- High reliable contacts, bifurcated gold overlay silver alloy (cadmium free)
- Conform to UL61010-1, UL61010-2-201, IEC/EN61010-1, IEC/EN61010-2-201 (max. 277VAC)
- Dielectric strength: 3,000VAC
- Surge strength: 5,080V
- Safety standards
UL, CSA, VDE, CQC
- RoHS compliant
- Plastic sealed type, RTIII



■ APPLICATIONS

PLC, FA equipment etc.

■ PARTNUMBER INFORMATION

[Example] $\frac{\text{FTR-MY}}{\text{(a)}} \frac{\text{A}}{\text{(b)}} \frac{\text{A}}{\text{(c)}} \frac{\text{012}}{\text{(d)}} \frac{\text{D}}{\text{(e)}}$

(a)	Relay type	FTR-MY	: FTR-MY Series
(b)	Contact configuration	A	: 1 form A
(c)	Coil type	A	: Standard type (110mW)
(d)	Coil rated voltage	012	: 4.524VDC See coil rating table
(e)	Contact material	D	: Gold overlay AgNi

Actual marking does not carry the type name : "FTR"
E.g.: Ordering code: FTR-MYAA012D Actual marking: MYAA012D

FTR-MY Series

■ SPECIFICATIONS

Item		FTR-MY	Remarks/Conditions	
Contact data	Configuration	1 form A		
	Construction	Bifurcated (cross bar)		
	Material	Gold overlay silver alloy		
	Resistance (initial)	Max. 30 mΩ at 6VDC, 1A		
	Contact rating	5A, 250VAC / 30VDC		
	Max. carrying current	5A		
	Max. switching current	5A		
	Max. switching voltage	277VAC / 125VDC		
	Max. switching power	1,250VA / 150W		
	Min. switching load *	1mA, 5VDC		
Coil data	Rated power (at 20°C)	110 mW		
	Operate power (at 20°C)	54 mW		
	Operating temperature range	-40°C to +90°C (no frost)		
Timing data	Operate (at nominal voltage)	Max. 10 ms (without bounce)		
	Release (at nominal voltage)	Max. 5 ms (without bounce)		
Life	Mechanical	Min. 20 x 10 ⁶ operations		
	Electrical	Min. 100 x 10 ³ operations (at 3A 250VAC, 30VDC resistive) Min. 50 x 10 ³ operations (at 5A 250VAC, 30VDC resistive)		
Insulation	Resistance (Initial)	Min. 1,000MΩ at 500VDC		
	Dielectric strength	Open contacts	750VAC (50/60Hz) 1min	
		Contacts to coil	3,000VAC (50/60Hz) 1min	
	Surge strength	Coil to contacts	5,080V / 1.2 x 50μs standard wave	
	Clearance		Min. 5.15mm	
Creepage		Min. 5.89mm		
Others	Vibration resistance	Misoperation	10 to 55 to 10 single amplitude 0.75mm	Coil ON/OFF, 3 axes, total 6 cycles
		Endurance	10 to 55 to 10 single amplitude 2.5mm	Coil OFF, 3 axes, total 6 hours
	Shock resistance	Misoperation	Min. 100m/s ² (11 ± 1ms)	Coil ON/OFF, 3 axes, total 36 operations
		Endurance	Min. 1,000m/s ² (6 ± 1ms)	
	Weight		Approximately 2.5 g	
	Sealing		Plastic sealed RTIII	

* Minimum switching loads mentioned above are reference values. Please perform the confirmation test with actual load before production since reference values may vary according to switching frequencies, environmental conditions and expected reliability levels.

FTR-MY Series

■ COIL DATA

Coil Code	Rated Coil Voltage (VDC)	Coil Resistance $\pm 10\%$ (Ω)	Must Operate Voltage* (VDC)	Must Release Voltage* (VDC)	Rated Power (mW)
4.5	4.5	185	3.15	0.225	110
005	5	230	3.5	0.25	
006	6	330	4.2	0.3	
009	9	740	6.3	0.45	
012	12	1,310	8.4	0.6	
018	18	2,950	12.6	0.9	
024	24	5,240	16.8	1.2	

Note: All values in the table are valid for 20°C and zero contact current.

* Specified operate values are valid for pulse wave voltage.

Please use at rated coil voltage. Please refer to characteristic data and set up adequate voltage in case of use at over voltage.

■ SAFETY STANDARDS

Type	Compliance	Contact Rating
UL	UL 508 ANSI/ISA 12.12.01 E63614, E225300	Flammability: UL94-V0 (Plastics)
		5A, 277 VAC (resistive) 5A, 30 VDC
CSA	C22.2 No. 14 LR 40304	1/10 HP, 277VAC /125VAC Pilot duty: D300, C300, R300
VDE	IEC/EN61810-1	5A, 250VAC, $\cos\phi 1$
CQC	GB15092.1 11001063129, 17001164877	5A 250VAC

Also conform to UL61010-1, UL61010-2-201, IEC/EN61010-1, IEC/EN61010-2-201 (max. 277VAC)

WARNING: Exposure to some chemicals may degrade the sealing properties of materials used in the relay.

FTR-MY Series

■ DIMENSIONS

- Dimensions

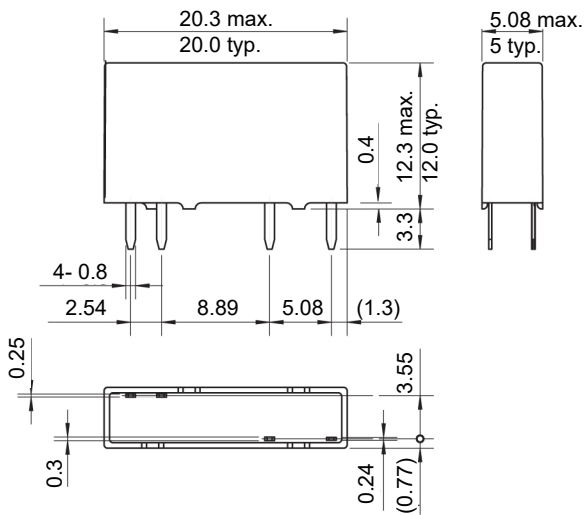

- Schematics (BOTTOM VIEW)

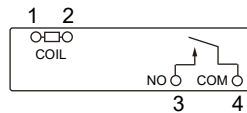

- PC board mounting hole layout (BOTTOM VIEW)

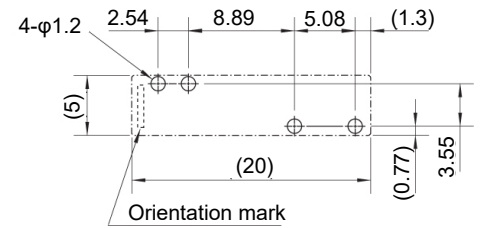

* Dimensions of the terminals do not include thickness of pre-solder.

* Tolerance of PC board mounting hole layout: ± 0.1 unless otherwise specified.

() : Reference
Unit: mm

FTR-MY Series

CHARACTERISTIC DATA

(Characteristic data is not guaranteed value but measured values of samples from production line)

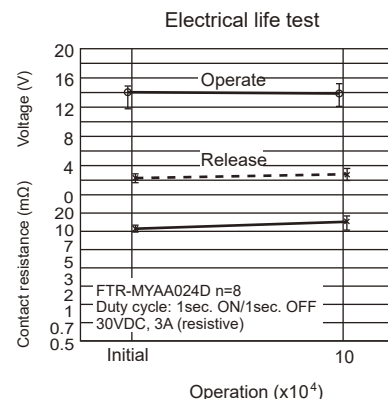
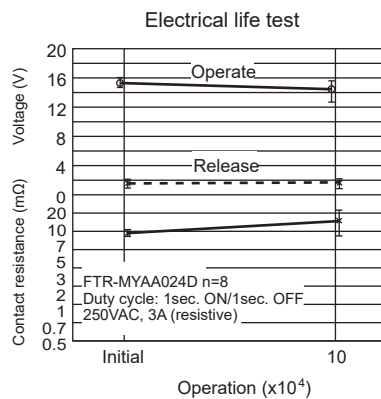
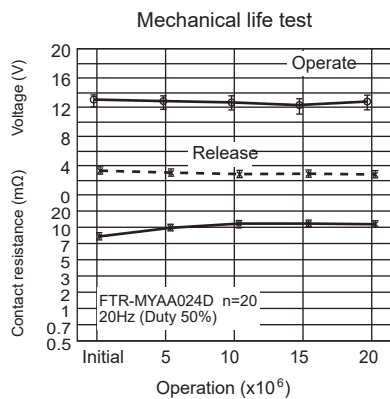
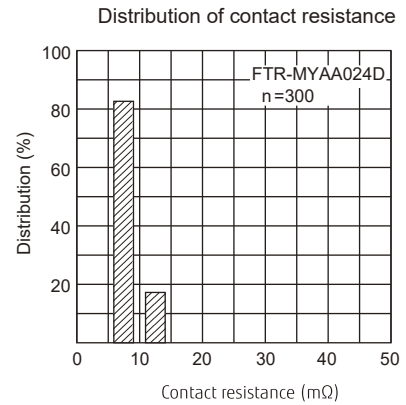
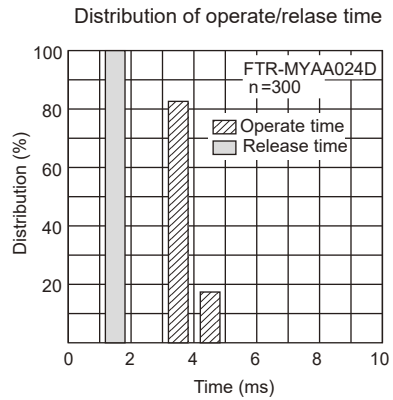
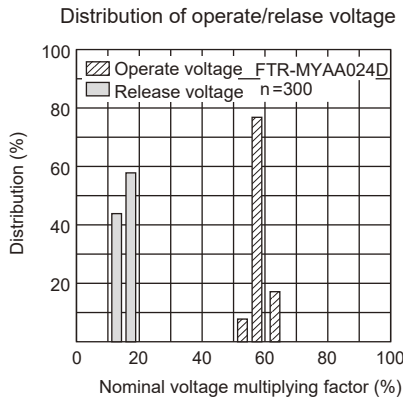
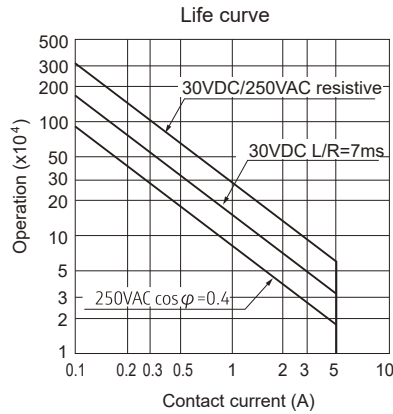
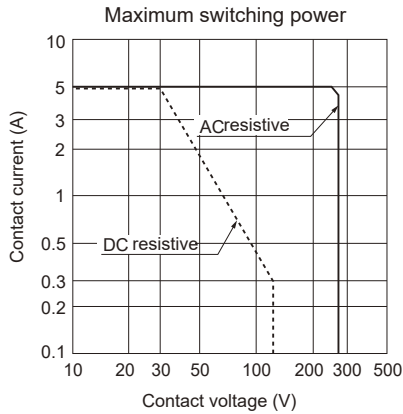
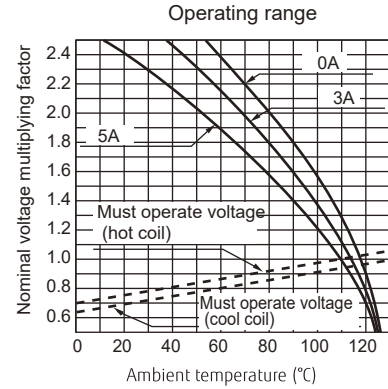
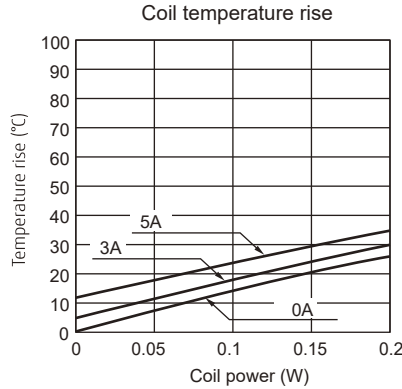
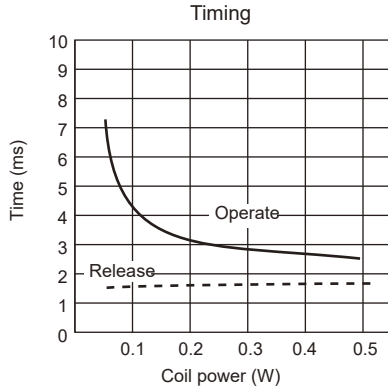

FTR-MY Series

CAUTIONS

- All values mentioned in this datasheet are provided under ideal conditions. Please perform the confirmation test before actual use.
- Reflow soldering is prohibited.
- Do not use relays in the atmosphere with sulfide gas, chloride gas or nitric oxide. Contact resistance may increase.
- Do not use silicon or silicon-containing product or materials near relays. It may cause contact failure.

GENERAL INFORMATION

1. ROHS Compliance

- All relays produced by FCL Components are compliant with RoHS directive 2011/65/EU, including commission delegated directive 2015/863.

2. Recommended lead free solder condition

- Lead free solder plating on relay terminals is Sn-3.0Ag-0.5Cu, unless otherwise specified. This material has been verified to be compatible with PbSn assembly process.
- Recommended solder for assembly: Sn-3.0Ag-0.5Cu.

Flow Solder Condition:

Pre-Heating: Maximum 120°C within 90 sec.

Soldering: Dip within 5 sec. at 255°C±5°C solder bath

Relay must be cooled by air immediately after soldering

Solder by Soldering Iron:

Soldering Iron: 30-60W

Temperature: Maximum 340-360°C

Duration: Maximum 3 sec.

We highly recommend that you confirm your actual solder conditions

3. Moisture Sensitivity

- Moisture Sensitivity Level standard is not applicable to electromechanical relays, unless otherwise indicated.

4. Tin Whiskers

- Dipped SnAgCu solder is known as presenting a low risk to tin whisker development. No considerable length whisker was found by our in house test.

Contact

Japan

FCL COMPONENTS LIMITED
Shinagawa Seaside Park Tower
12-4, Higashi-shinagawa 4-chome,
Tokyo 140 0002, Japan
Tel: +81-3-3450-1682
Email: fcl-contact@cs.fcl-components.com

North and South America

FCL COMPONENTS AMERICA, INC.
2055 Gateway Place Suite 480,
San Jose, CA 95110 USA
Tel: +1-408-745-4900
Email: fcai.components@fcl-components.com

Europe

FCL COMPONENTS EUROPE B.V.
Diamantlaan 25
2132 WV Hoofddorp, Netherlands
Tel: +31-23-556-0910
Email: info.fceu@cs.fcl-components.com

Asia Pacific

FCL COMPONENTS ASIA PTE LTD.
No. 20 Harbour Drive, #07-01B
Singapore 117612
Tel: +65-6375-8560
Email: fcal@fcl-components.com

China

FCL COMPONENTS (SHANGHAI) CO.,LTD.
Unit 1105, Central Park - Jing An,
No.329 Heng Feng Road, Shanghai
200070, China
Tel: +86-21-3253 0998
Email: fclsh@fcl-components.com

Hong Kong

FCL COMPONENTS HONG KONG CO., LIMITED
Unit 2313, Seapower Tower, Concordia
Plaza, No.1 Science Museum Road,
TST, Kowloon, Hong Kong
Tel: +852-2881-8495
Email: fcal@fcl-components.com

Web: www.fcl-components.com/en/

© 2024 FCL Components Limited. All rights reserved. All trademarks or registered trademarks are the property of their respective owners.

FCL Products are intended for general use, including without limitation, in personal, household and office environments, in buildings and for ordinary use in the industry. FCL Products are not intended to be used in applications where extremely high safety is required ("High Safety Required Applications"), such as, but not limited to, applications in nuclear facilities, in aircraft automatic flight control, in air traffic control, in mass transit system control, in missile launch system, in weapon systems, in medical equipment for life support or any application involving a direct serious risk of physical injury or death.

Please do not use FCL Products without securing the sufficient safety and reliability required for the High Safety Required Applications. In addition, FCL shall not be liable against the customer and/or any third party for any claims or damages arising in connection with the use of FCL Products in the High Safety Required Applications.

FCL warrants that its Products, if properly used and services, will conform to their specification and will be free from defects in material and workmanship for twelve months from delivery.

The implied warranties of merchantability and fitness for a particular purpose and all other warranties, representations and conditions, express or implied by statute, trade usage or otherwise, except as set forth in this warranty, are excluded and shall not apply to the Products delivered.

The contents, data and information in this datasheet are provided by FCL Components Limited as a service only to its user and only for general information purposes. The use of the contents, data and information provided in this datasheet is at the users' own risk.

FCL has assembled this datasheet with care and will endeavor to keep the contents, data and information correct, accurate, comprehensive, complete and up to date.

FCL Components Limited and affiliated companies do however not accept any responsibility or liability on their behalf, nor on behalf of its employees, for any loss or damage, direct, indirect or consequential, with respect to this datasheet, its contents, data, and information and related graphics and the correctness, reliability, accuracy, comprehensiveness, usefulness, availability and completeness thereof.

Nor do FCL Components Limited and affiliated companies accept on their behalf, nor on behalf of its employees, any responsibility or liability with respect to these datasheets, its contents, data, information and related graphics and the correctness, reliability, accuracy, comprehensiveness, usefulness, availability and completeness thereof. Rev. June 18, 2024.
