

Murata Products for

Medical Applications



Block diagrams

- Insulin pump04
- Diagnostic imaging apparatus..04
- Thermometer.....04
- Blood pressure monitor05
- Blood glucose meter05
- Skin patch.....05
- Hearing aid05

Murata products

- Multi-layer ceramic capacitors06
- Silicon capacitors & IPDs07
- Polymer Aluminum Capacitors (PAC).....08
- Chip inductors.....08
- EMI filters08
- Timing devices.....09
- Switch connectors, Multi-line connectors and Test probes10
- Buzzers11
- NTC thermistors11
- AMR sensors (magnetic switches).....12
- RFID.....12
- Bluetooth® Low Energy modules.....13
- Wi-Fi® + Bluetooth® modules13
- LPWA modules.....14
- UWB modules.....15
- AI modules15
- LTCC filters15
- Micro batteries (primary batteries).....16
- Stretchable electronics.....17
- Ionizer & Ozonizer18
- Microblower (air pump).....18
- Limitation of applications19



Rising healthcare costs are being driven by three factors



As countries' finances become even more strained, healthcare will be under pressure to...

reduce costs and improve efficiency

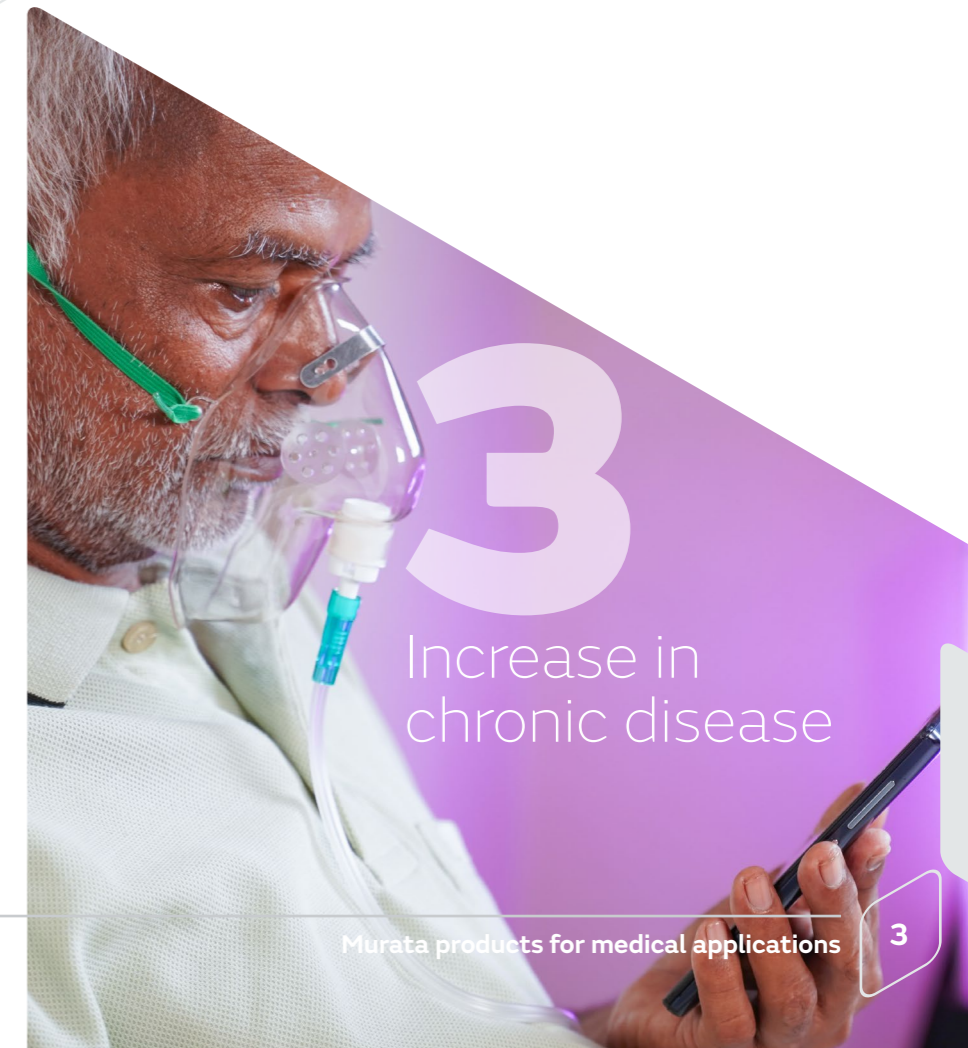

Longer & healthier life

Limited medical budgets and medical personnel resources require more efficient medical care...
Value-based healthcare
 As conventional medical device manufacturers reach maximum output, conventional medical equipment plus α is required.

New technologies

New value chain

New players

Data importance rising

Market scale increasing

Trend 1 Disease prevention

- Connected healthcare
- Tele-health

Trend 2 Personalized medicine

- Gene therapies
- Lifestyle

Trend 3 Minimally-invasive treatment

- Prescribing of drugs
- Surgical technology

Medical applications

Where do Murata components offer and advantage?

Environmental changes surrounding healthcare affect personal healthcare devices used for daily health management, with such products becoming more compact and gaining the ability to connect to the cloud.

Murata's products contribute to:

- The ability to create more compact products and exercise more design freedom thanks to the availability of compact general-purpose components (capacitors, inductors, etc.)
- The ability to easily create daily health monitoring products with network connectivity due to the availability of Bluetooth® Smart Modules, wireless communication modules supporting near-field communication (NFC), etc.

Insulin Cartridge

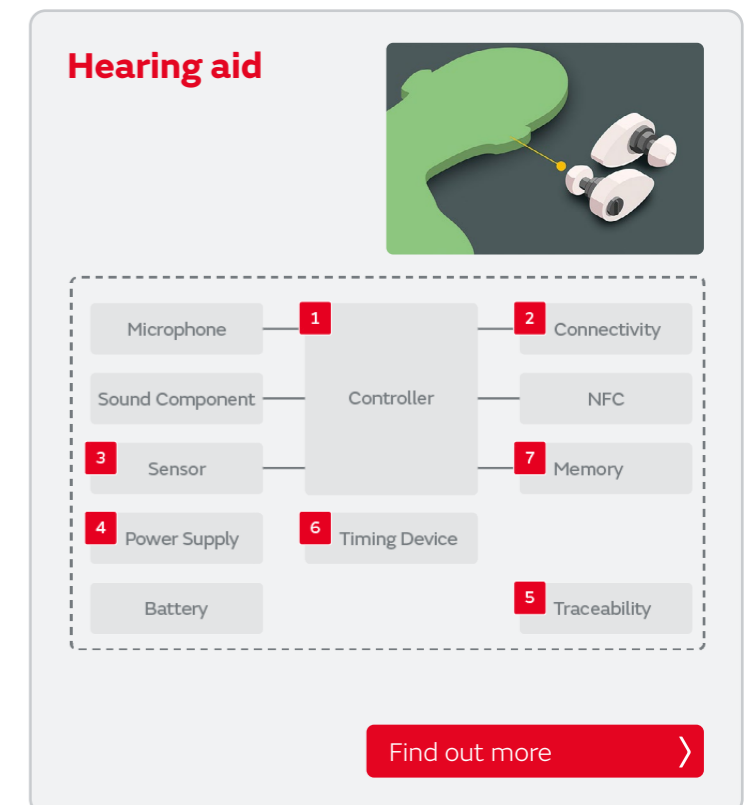
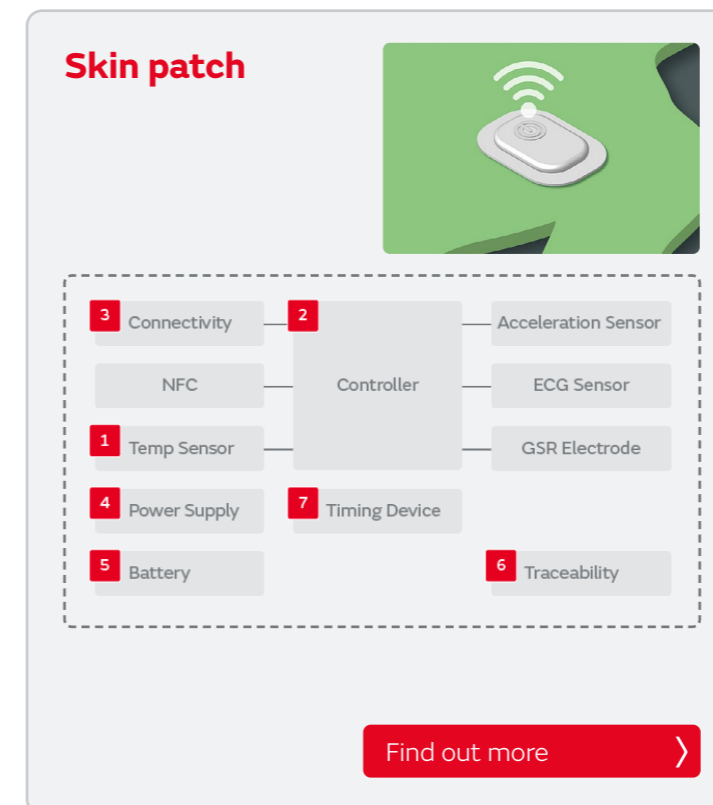
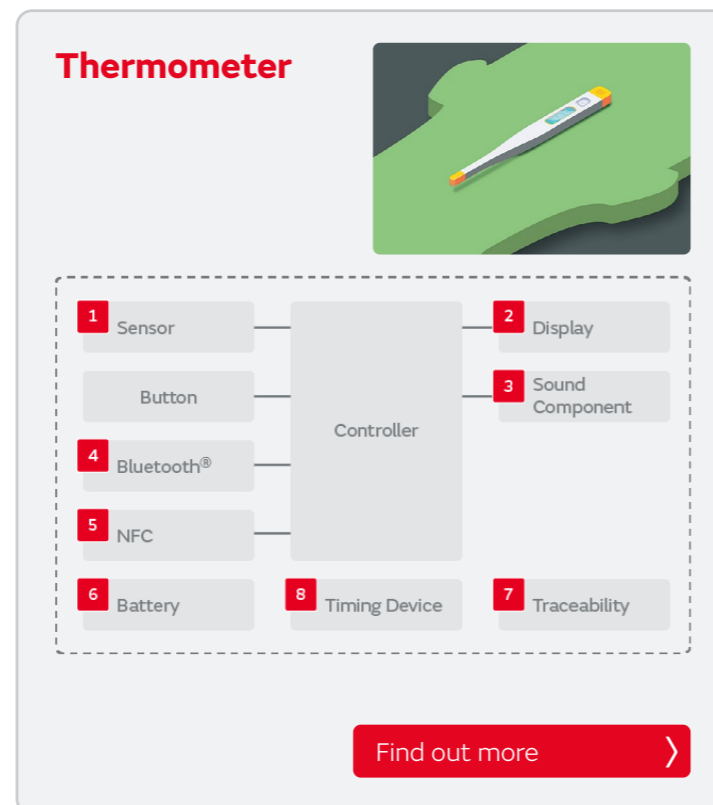
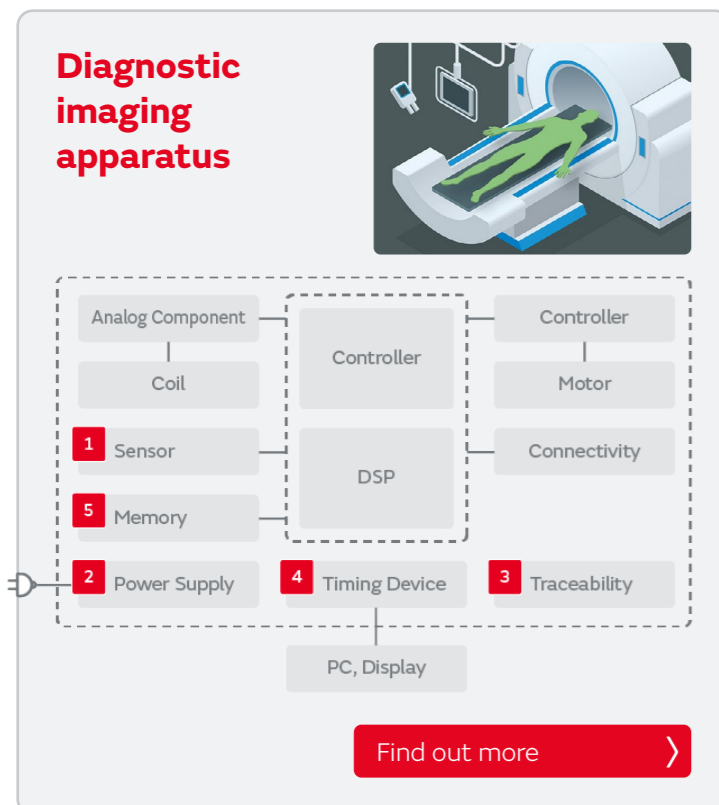
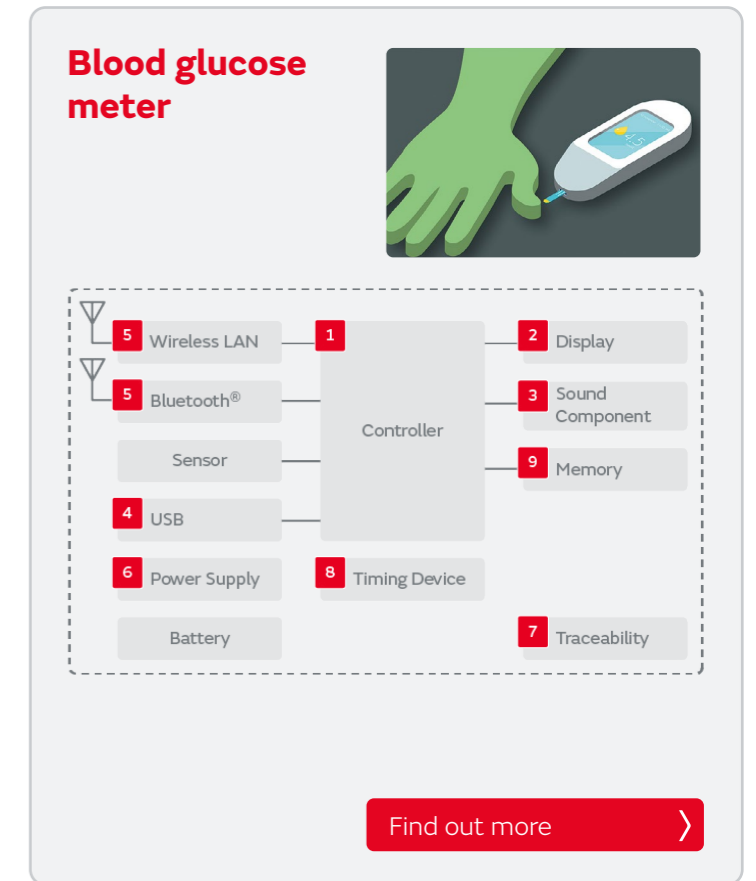
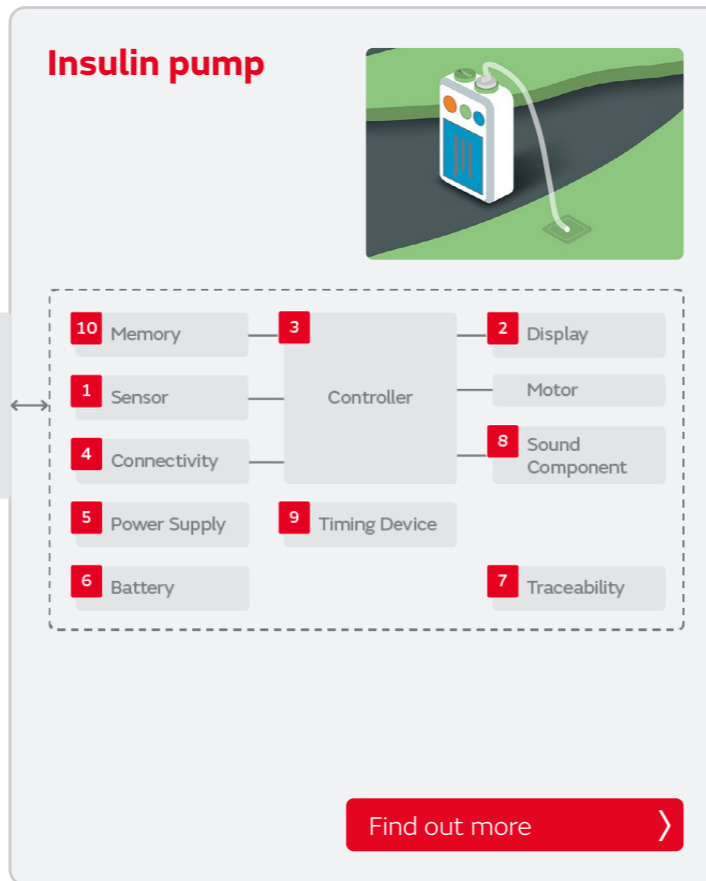

Murata products

Sold for use in medical devices in Classes: **A B C D**

Many series are available for Medical Grade A, B and C, and there are also Grade D supportable series.

Multi-layer ceramic capacitors



Murata offers the No. 1 most abundant lineup in the industry, responding to all possible needs, and proposing ideal solutions. Medical-grade ceramic capacitors are available for use in devices of medical class D such as implanted cardiac pacemakers.

Features

- High Quality
- High Supply Capability
- High Development Capability
- Extensive Lineup

Applications

- Pacemakers
- Insulin Pumps
- Blood glucose meters

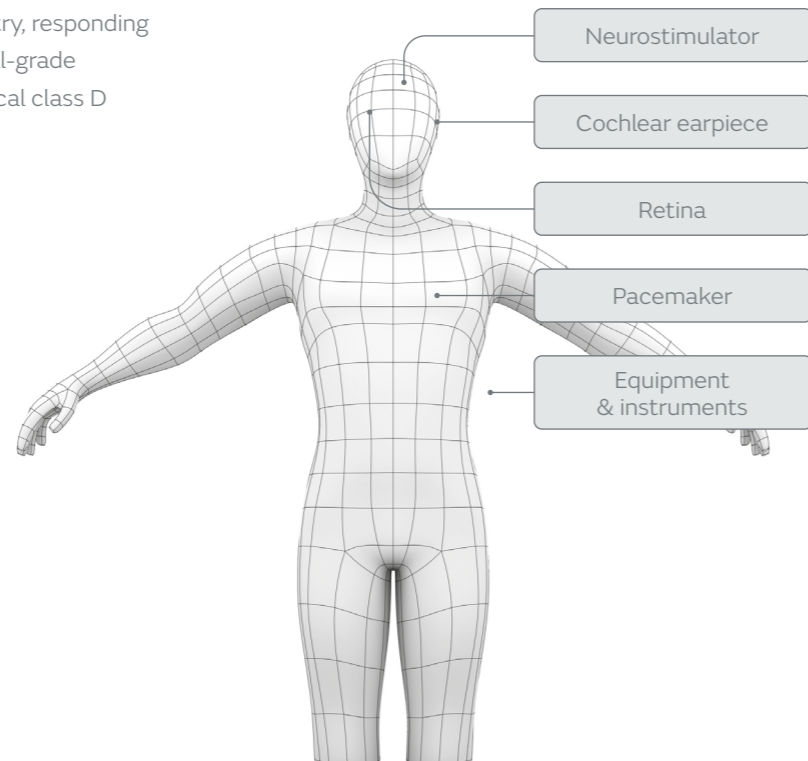

Pacemaker circuit diagram

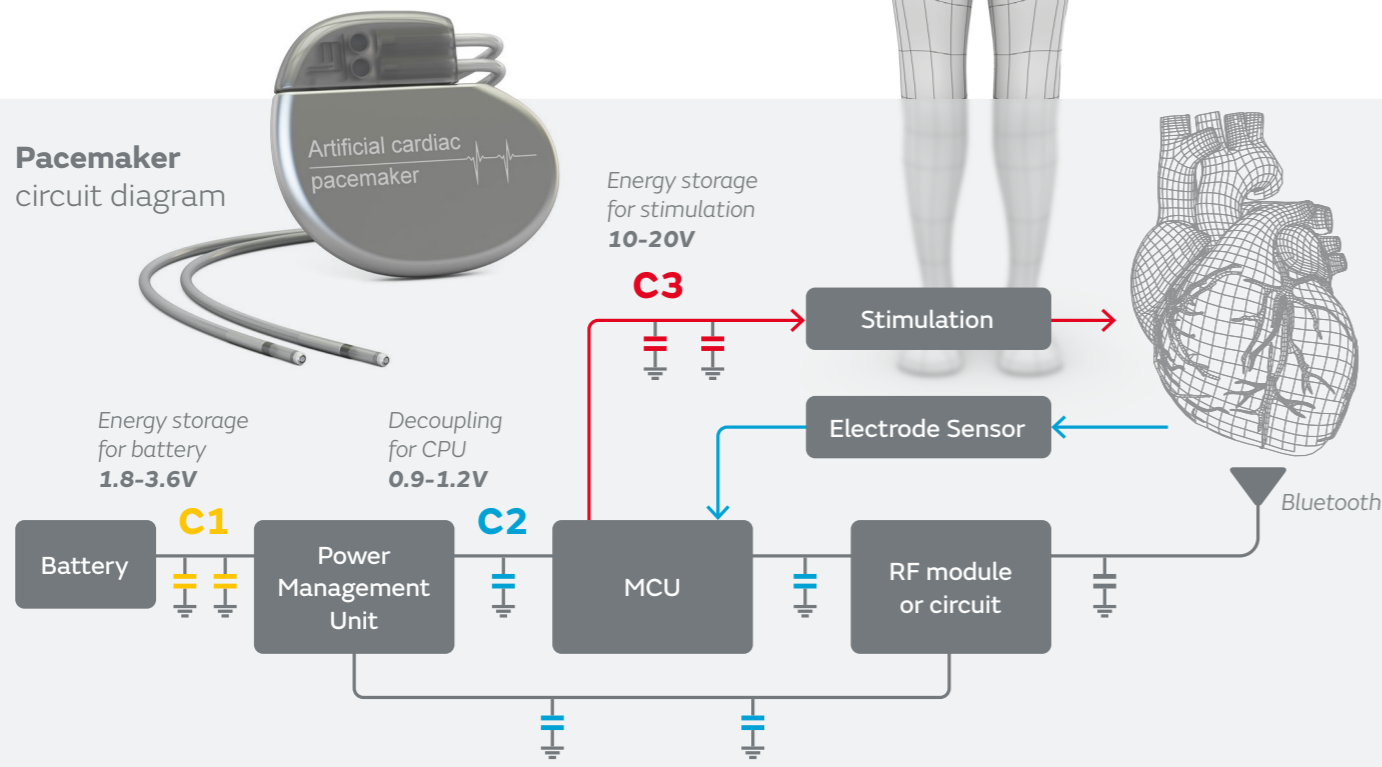

[Find out more >](#)

Murata products

Sold for use in medical devices in Classes: **A B C D**

Silicon capacitors and IPDs

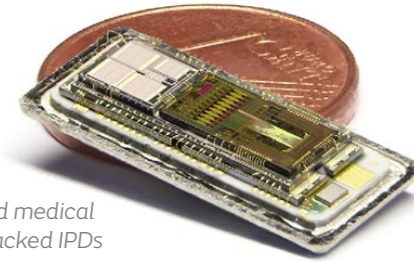

A full integrated medical system with stacked IPDs

Murata has a long and successful history in implantable medical systems, by providing since many years mainly custom Integrated Passive Devices. We not only provide medical grade silicon capacitors (MGSC series) but also design specific IPDs for the main actors of the domain, who stack them with their active components. This is made for example in pacemakers or neurostimulators, in order to integrate even more the systems, to gain both in current consumption and reliability.

Features

- High reliability.
- Extreme low profile (100µm).
- High stability over voltage, temperature and aging.
- Die to die stacking.
- Finishing & assembly: Aluminum pads suitable for wirebonding assembly. Copper finishing option for embedded technology.

Applications

- Pacemakers and defibrillators
- Implantable neuro-stimulators
- Active prosthesis (artificial heart, electronic retina, mechanical limb prosthesis...)
- Life support equipment

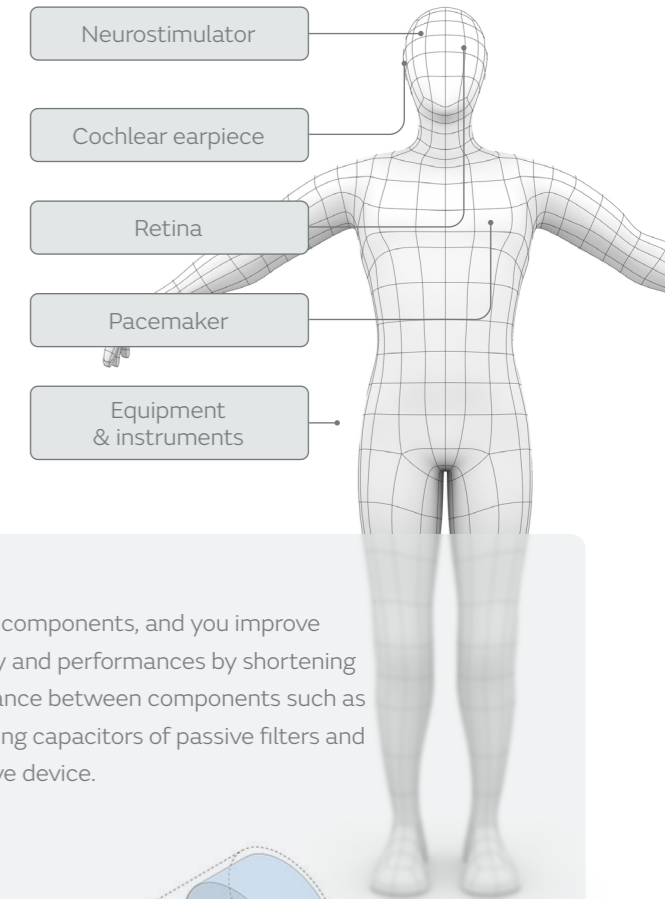

Custom Integrated Passive Devices (IPDs)

Murata offers the integration of multiple passive devices into a single package to even improve the integration of your system. This goes from capacitors arrays to complex Integrated Passive Solutions (IPDs) embedding different types of capacitors, resistors or connections. Thanks to this stackable IPDs, you win space in your design, you avoid the mounting of multiple

discrete components, and you improve reliability and performances by shortening the distance between components such as decoupling capacitors of passive filters and the active device.

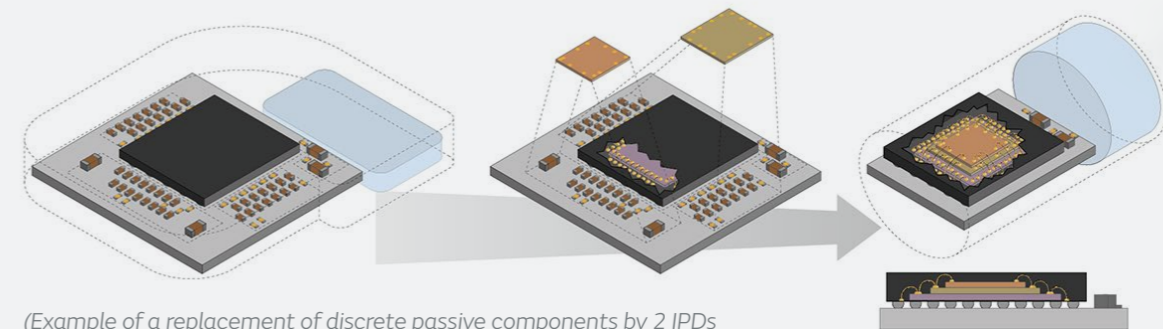

(Example of a replacement of discrete passive components by 2 IPDs that are stacked, bumped and molded together with the active die.)

Please contact Murata sales before using our products for Medical applications which require especially high reliability for the prevention of defects which might directly cause damage to the third party's life, body or property.

[Find out more >](#)

Murata products

Sold for use in medical devices in Class **A B C**

Polymer Aluminum Capacitors (PAC)



Murata's polymer capacitors are suitable for smoothing the input-output current of various power supply circuits, and the backup use over the load change of the CPU circumference.

Features

- High capacitance
- ESR: 4.5 to 40mΩ
- No acoustic noise issue
- Stable capacitance for DC bias and temperature

Applications

- Blood Glucose Meter
- Endoscope peripherals
- Image processing

[Find out more](#)

Example application circuit - blood glucose monitor



Sold for use in medical devices in GHF Class A, B & C except for implant, operation, and auto-dispenser equipment **A B C**

Chip inductors



LQM18DN100M70

Overview

Many devices for medical IoT applications are small in size - such as beacons and active trackers - requiring power inductors that are compact and cost-effective. With its small 0603 size and multi-layer ferrite core, the LQM18DN100M70 is ideally suited for use in Bluetooth® low energy applications in these devices, providing low Rdc while delivering high inductance of 10 μH and superior DC superimposition characteristics.

Features

- Small size (1608mm/0603 inch)
- Low Rdc

Applications

- Medical devices with Bluetooth® Low Energy
- CGM, insulin pen, blood pressure monitor, thermometer, etc.

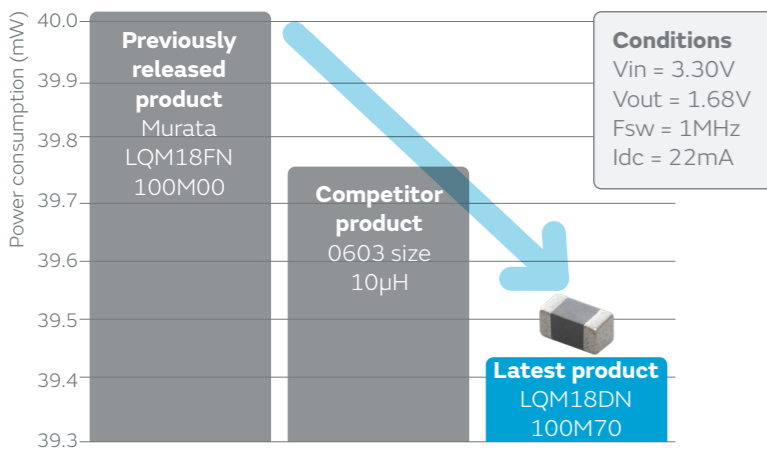

Delivering lower power consumption

[Find out more](#)

EMI filters



BNX series

The BNX series of wideband EMI noise suppression filters is ideal for DC power lines. This series offers super-high performance in a single SMD package, delivering noise measures at high current across a wide frequency range.

Features

- High current support (e.g. 20A)
- Wideband design (e.g. 15kHz-1GHz: insertion loss of 35dB or more)
- Volume reduction

Applications

- Diagnostic imaging apparatus
- Ultrasonograph
- Bedside Monitor
- Endoscope, etc.

High insertion loss at wide frequency range

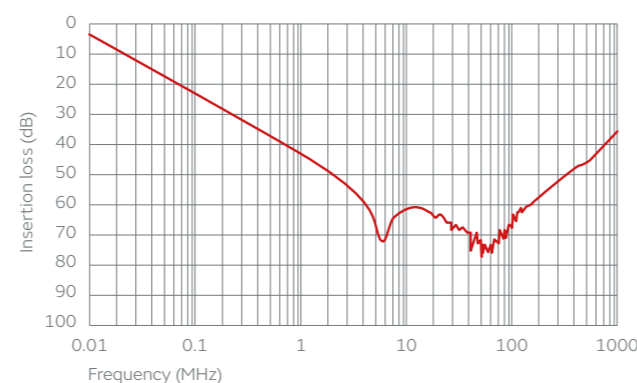

[Find out more](#)

Murata products

Sold for use in medical devices in Class **A B C**

Timing devices

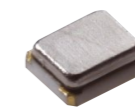

Crystal units

Our particle screening process ensures that Murata crystals can achieve the high reliability requirements of medical equipment, making them the best fit to for connectivity functions in medical applications, such as Bluetooth® LE, Wi-Fi®, etc.

Features

- High quality
- Stable supply
- RoHS compliant
- Robust and economic design

Applications

- Glucose monitor
- Insulin pen/patch
- Medical patch
- Thermometer
- Wearable

Murata crystal unit

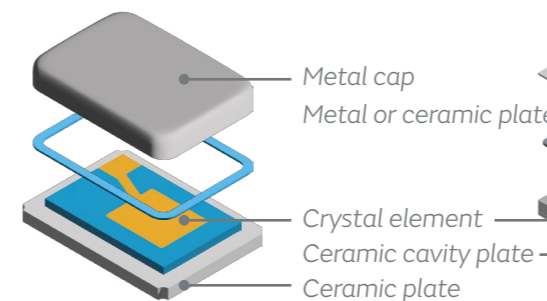

Conventional crystal unit

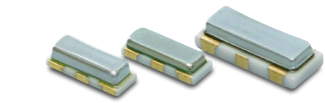
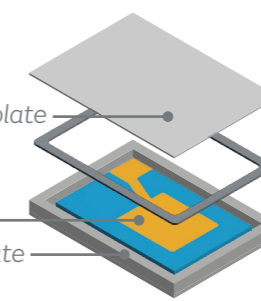

Ceramic resonators (CERALOCK)

Murata's ceramic resonators are smaller in size than conventional crystal units. Furthermore, because they feature 2 built-in capacitors, even more space is saved in the associated circuit. Murata has been supporting these devices to various markets for over 20 years.

Features

- Built-in capacitors
- High drop and high mechanical shock performance
- Low frequency and small package
- RoHS compliant
- Fast rise times

Applications

- Glucose meters
- Injectors
- Inhalers
- Thermometers
- Diagnostic equipment

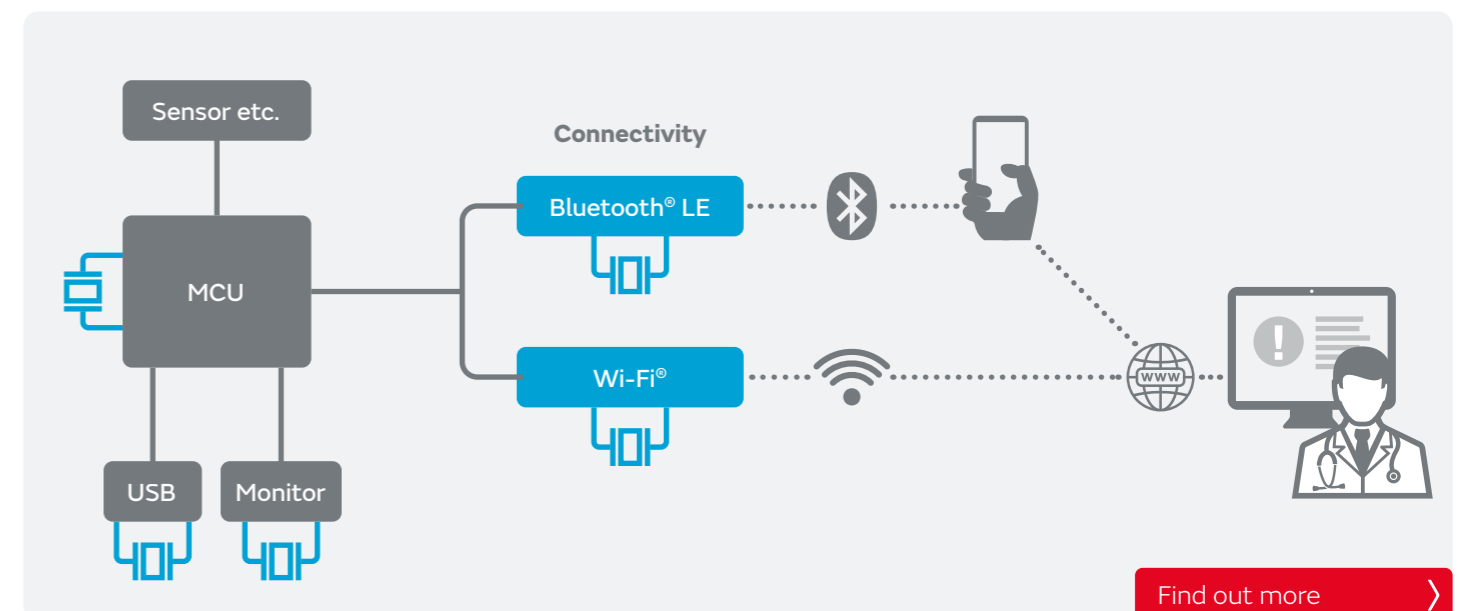
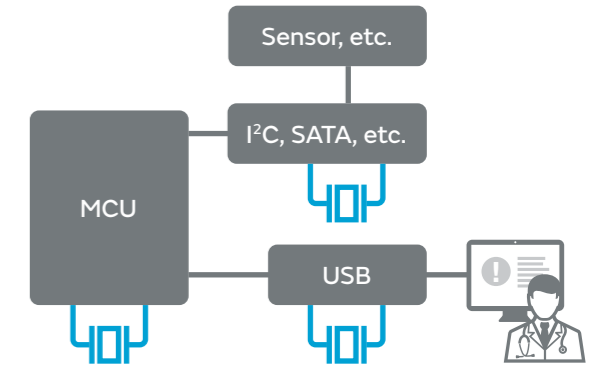

[Find out more](#)

Switch connectors, Multi-line connectors and Test probes

Switch connector & test probes

The built-in mechanical switch separates the RF circuit and ANT circuit, so that the circuit can be measured without any mutual effect using a dedicated probe made by Murata.

Multi-line connectors & test probes

Multi-line connectors transmit signals from board to board. The connectors can transmit not only digital signals but also RF signals, and are used for various devices, predominantly mobile phones and wearable devices.

Features

Switch connector & test probes

- Small size (SWJ series: 1.4 x 1.2 x 0.65mm)
- Reliable spring structure
- High frequency

Multi-line connectors & test probes

- Space saving - handles both RF and digital signals
- Center shield ensures isolation between opposite terminals
- Robust construction
- High frequency

Applications

- Switch connector can perform power calibration and check RF performance.
- Multi-line connector can connect RF signal and digital by one connector.
- Test probes can be provided to suite the customer's requirements.



[Find out more >](#)

Buzzers

Piezoelectric sounders are sound components which generate sound suitable for use as input signals (including multi-tone, melody and so forth) without built-in oscillation circuits. This characteristic allows them to be used in a wide range of applications. They come as the SMD type, which is optimal for small, high-density mounting and the pin type, which can be used for general purposes.



Features

- Small size & low profile
- Low current consumption → Battery long life
- High sound pressure (high sound volume)
- Easy assembly
- Low characteristics fluctuation before & after reflow

Applications

- Thermometer
- Blood pressure monitor
- Blood glucose monitor
- Insulin pump



[Find out more >](#)

NTC thermistors

Excellent thermal response suitable for temperature sensing and monitoring, temperature compensation for Medical applications with smaller size.



Features

- Small size 1608/1005
- Various resistance line up
- Tighter resistance tolerance
- High reliability

Applications

- Glucose Meter
- CGM (Continuous Glucose Monitoring)
- Hearing Aid
- Vital Sensing Wearable



[Find out more >](#)

Series	Dimensions	R25	R tolerance	B-Const. (25/50°C)
NCU15	1.0 x 0.5 mm	10kΩ 47kΩ 100kΩ etc.	0.5% to 5%	3380K 4050K 4250K etc.
	0.4 x 0.2 in			
NCU18	1.6 x 0.8 mm			
	0.6 x 0.3 in			

Murata products

AMR sensors (magnetic switches)

Anisotropic magnetoresistance (AMR) sensor ICs in digital output for position and rotation detection. Detect the magnetic field from a permanent magnet and respond to either pole (north or south) so that AMR sensors work as magnetic switch.

Features

- High sensitivity
- Low current consumption
- Robust
- Small package

Applications

- Dose counter of auto-injector
- Wake up switch for battery driven devices i.e. capsule endoscopy
- Detaching detection for intravenous drip

Series	Dimensions	Supply voltage range	Current consumption (typ.)	Operating magnetic field (Hon)
MRMS201A	2.8 x 2.9 x 1.1mm	1.6-3.5V	5.0µA (V _{CC} =3.0V)	Max. 2.5mT
MRMS501A	1.45 x 1.45 x 0.55mm		3.0µA (V _{CC} =1.8V)	
MRMS581P		1.8-3.5V	0.3µA (V _{CC} =3.0V)	

Sold for use in medical devices in Class **A B**



RFID

Murata's RFID & NFC micro tags are providing the next generation of medical products and devices with the intelligence required for item tracking, system automation and enhanced security features.

Features

- Available in UHF & HF technology
- Ultra small size -1.25 x 1.25mm (UHF)
- Fully integrated antenna
- Suitable for injection molding process
- Durable design
- Adheres to global standards

Applications

- Manufacturing traceability
- Brand protection
- Product authentication
- Inventory management
- Surgery tool management
- Medication control system
- Asset management
- Consumable product validation

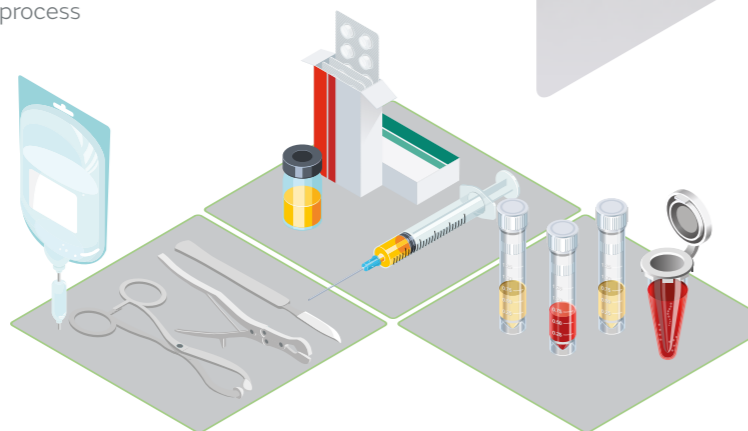

Sold for use in medical devices in Class **A B**

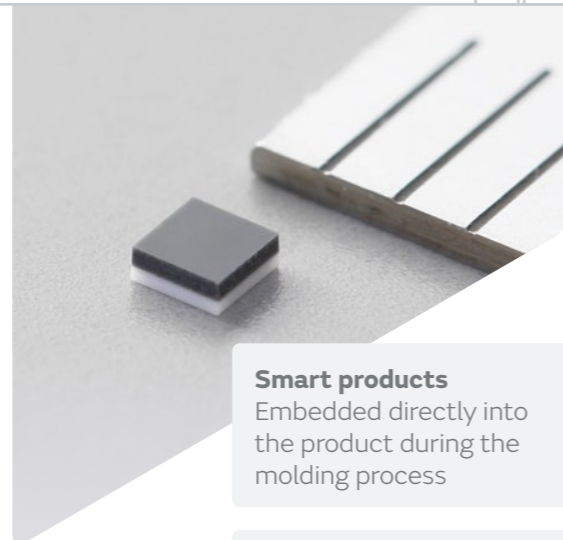

Smart products
Embedded directly into the product during the molding process

Surgical tool tracking
Patented technology uses metal objects as the antenna for RFID tags

Product authentication
Item identification allows validation of the contents

[Find out more >](#)

Murata products

Bluetooth® Low Energy modules

Sold for use in medical devices in Class **A B**

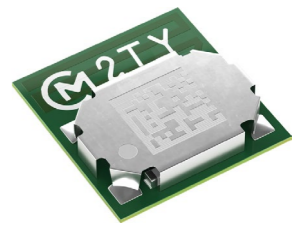

Ultra-small, high quality and lower power

Module features low current consumption, and internal antenna. Ideally suited for small, battery operated IoT devices and applications.

Features

- SIG certified modules
- You can connect your processor via UART or SPI interface
- Smaller area than CoB solution
- Internal antenna can be used

Applications

- Wrist Heart rate meter
- Wrist Sphygmomanometer
- Weight Meter
- Headset
- Smart speaker, etc



[Find out more >](#)

Wi-Fi® + Bluetooth® modules

Sold for use in medical devices in Class **A B**

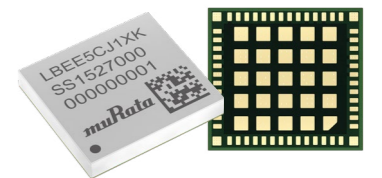

Wi-Fi® + Bluetooth® allows you to connect directly to the internet, so it is the most flexible wireless technology for your Healthcare/Medical products.

Features

- Ultra-small
- Support the latest IEEE standard
- A large variety of products (IEEE standard, IC vender)
- FCC/CE/IC/TELEC 'reference' certified
- Support antenna design

Applications

- Personal healthcare equipment**
- Blood pressure monitor
 - Blood glucose meter
 - Sleep monitoring device
- Medical equipment**
- Surgical stapler
 - Handheld ultrasound scanner
 - Nurse call system ...and more.



Block diagram (e.g. 2.4GHz & 5GHz Wi-Fi® + Bluetooth® module)

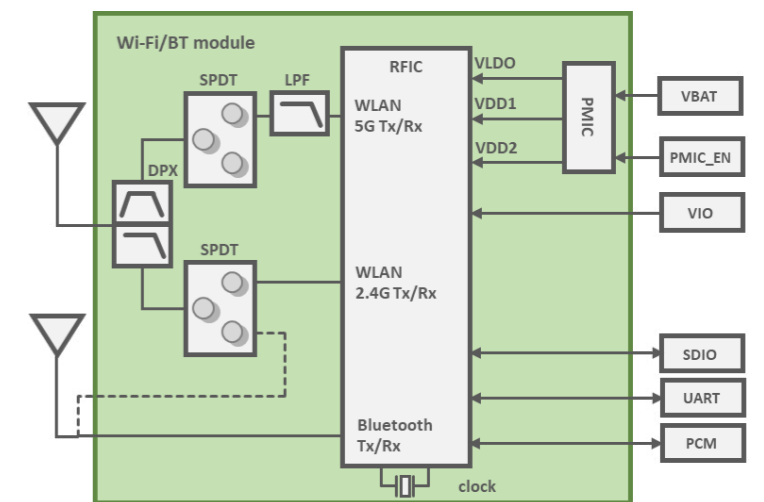

[Find out more >](#)

LPWA modules

LoRa, CAT-M1 & NB-IoT communications modules

LPWA (Low Power Wide Area) technology enables IoT (Internet of Things) applications which tend to require lower power consumption and longer range coverage.

Although the data transfer rates are comparatively slower than existing wireless communication technologies such as Wi-Fi®, Bluetooth®, mobile networks, etc., LPWA technology is predicted to be widely used for IoT and M2M communications as it enables lower power consumption of connected devices. Murata offers solutions for LoRa, CAT-M1 and NB-IoT.

Features

- Ultra-small size
- Low cost
- Good battery life - 10 years
- Long-range support - >10km
- Global certification support

Applications

- Patient Monitoring System
 - location / health status / emergency call
- Kids / Elder person monitoring system
- Smart Hospital / Warehouse
- Tracking System for Medicine / Vaccine

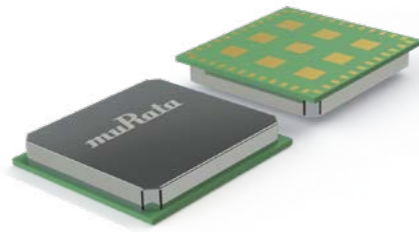

Murata LPWA support

Development of cellular LPWA modules for reliable connectivity

Support for antenna design & suggestions for optimal battery

Compliance with radio laws in destinations country and support for carrier certification

Types of LPWA

	Types of LPWA			LTE (reference)
	Cellular LPWA		Non-cellular LPWA	LTE Cat.1
	LTE-M	NB-IoT	LoRa	lte
Frequency band	Licensed band		Unlicensed band	Licensed band
Range	10km or more			5km
Data transfer rate	1Mb/s	<150kb/s	<10kb/s	5Mb/s
Transmission power	+23dBm	+23dBm	+20dBm*	+23dBm
Battery life	10 years or longer			-
Power consumption	Low	Low	Low	High
Cost	Low	Low	Low	High

*+20dBm is available in the U.S. only. EU and Asia use +14dBm

[Find out more >](#)

UWB modules

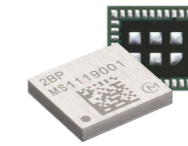

Overview

Murata Type 2BP is the ultra small UWB module which includes NXP's SR150 UWB chipset, clock, filters and peripheral components. The highly secure and accurate ranging technology is expected to be used in a variety of applications.

Features

- UWB channel Ch5, 9 support
- Interface SPI
- 3 antenna support (3D AoA or 2D AoA support)
- Reference clock and sleep clock embedded
- BPF (band pass filter) integrated for regulatory certification
- Small size (package resin mold + conformal shield)
- RoHS compliant

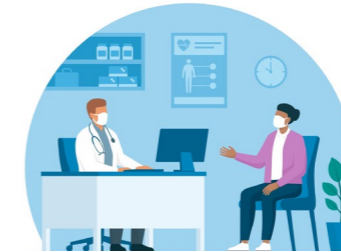

Ranging (Social distance)



Monitoring

Applications

- RTLS for hospitals
- Remote monitoring for hospitals

[Find out more >](#)

Edge AI modules

Overview

Murata develops and manufactures two types of AI modules to implement AI functions in various devices; one enables video/image analysis, the other (with ultra-low power consumption) enables voice-activated keyword detection, vibration pattern detecting, etc. These modules have the potential to enhance efficient medical practices, enable remote medical care, reduce patient burden, and bring other improvements in the healthcare environment.

Features

- Low Power Consumption
- SMD Type Module
- Small Size



Applications

- Various Healthcare Equipment (Bathroom Scales, Blood Pressure Monitor, etc.)
- Individual Authentication on Various Devices
- Image Analysis (Xray, fundus photograph, etc.)

[Find out more >](#)

LTCC filters

LTCC filter is passive components which pass or reject specific frequency band. This components are used for extracting the specific frequency band, or rejecting for noise reduction. Murata delivers high performance LTCC packaged product by multilayer ceramics integration technology.

Features

- Wide range line-up
baluns/BPFs/couplers/diplexers
0605 to 2012 size
- Smallest size
Integrate several L&C
0605/1005 size
- Excellent performance
Good Insertion Loss
High attenuation at high frequency

Applications

- For Bluetooth®
- For Wi-Fi®
- For ZigBee®

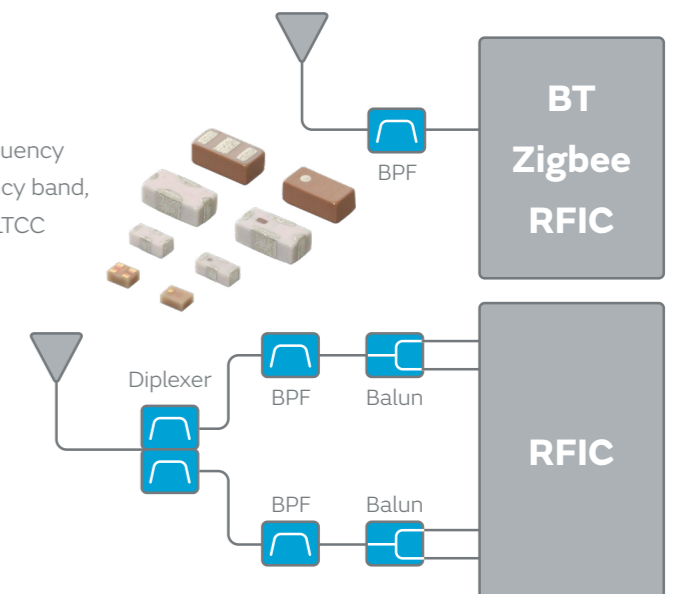

[Find out more >](#)

Micro batteries (primary batteries)

Overview

Murata offers a wide range of micro batteries with high performance and reliability, taking advantage of the state-of-the-art design and production technologies. The micro batteries we provide are the following three series:

- Coin Manganese Dioxide Lithium Batteries (CR series)
- Silver Oxide Batteries (SR series)
- Alkaline Manganese Batteries (LR series)

Features

- 40+ years technology development and manufacturing expertise
- Excellent leakage resistance
- Acquisition of ISO 9001/14001 certification

Applications

- Health monitoring devices (continuous glucose monitoring, thermometer, etc.)
- Drug delivery devices (insulin pump/pen, etc.)
- Capsule endoscopy

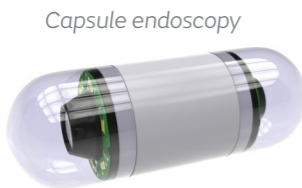

Capsule endoscopy



Insulin pump

Micro battery in continuous glucose monitoring

Sensor patch unit

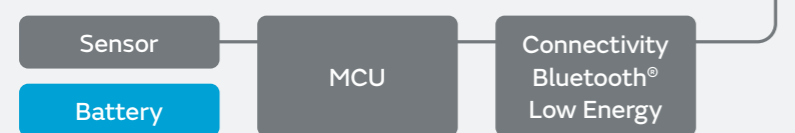

Controller unit (personal digital assistant type)

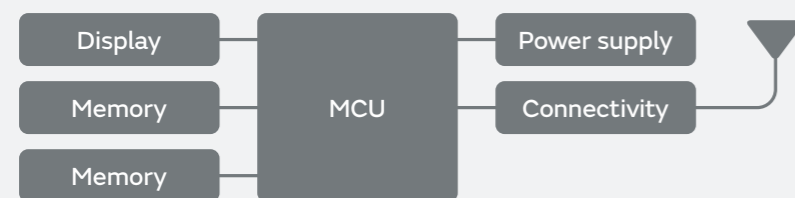

[Find out more >](#)

Stretchable electronics

Murata provides a wide range of promising solutions to enhance your novel medical devices for areas of the body which bend/stretch. Our stretchable electronics make your medical devices very soft and conformable, resulting in minimal skin damage. Depending on your needs, multiple sensing functionalities (e.g. electrode, temperature, light, acceleration) may be included. We use our competencies (e.g. printing, component mounting, lamination) while collaborating together with you to design and customize your innovative, biocompatible products.

Features

- Soft, thin, stretchable, and pliable
- Low skin damage risk
- Usable on body surfaces which bend/stretch
- Reliable continuous performance under high humidity/high voltage
- Increased functionality on single patch
- Design support, customization & integration

Applications

- Wearable devices with electrodes (e.g. ECG patch, EEG band, EIT belt, etc.)
- Wearable devices with sensor functions (temp, light, acceleration, etc.)
- Any kind of medical wearable devices for stretching/bending body areas



Concept product
Specifications and appearance are subject to change without notice

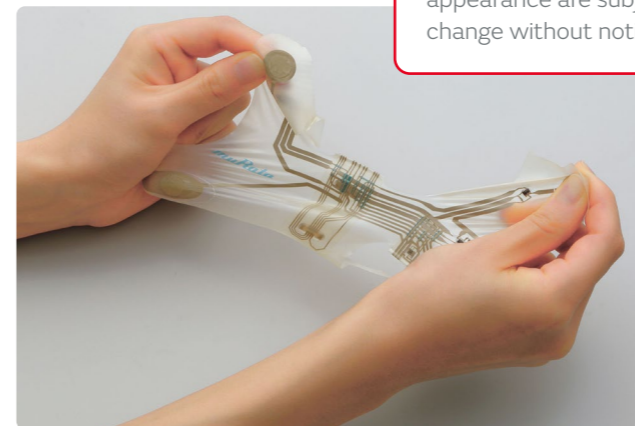

This product is under development. Specifications and appearance are subject to change without notice. Please contact us to discuss your requirements, regardless of medical device classification.

[Contact us >](#)

Ionizer & Ozonizer

Ionizer and Ozonizer modules utilize a high output voltage to create ionize/ozonize air molecules. These modules are for use in applications requiring sterilization, odor removal, air purifiers, prevention of mold and viruses, elimination of static energy and more. Compact designs with AC and DC input versions. User adjustable ozone concentration levels.

Features

- Design that separates the high voltage power supply from the ion /ozone generator
- Easy integration

Applications

- Air purifiers
- Sterilization apparatus
- Deodorant apparatus

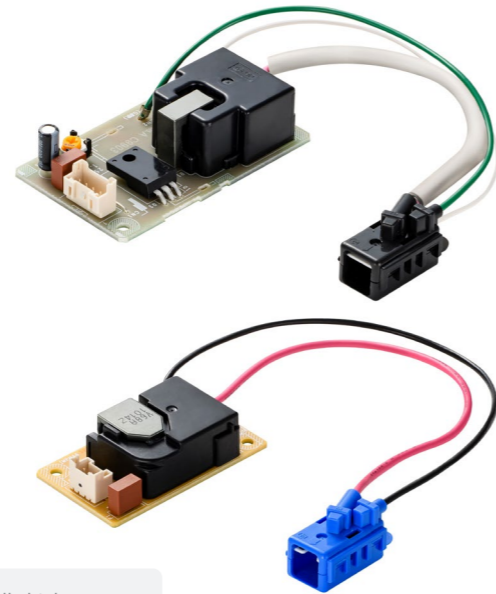

Find out more >

Please contact Murata sales before using our products for Medical applications which require especially high reliability for the prevention of defects which might directly cause damage to the third party's life, body or property.

Microblower (air pump)

Small, thin and silent air blower/pump utilizing piezo electrical technology.

Features

- Small and Thin size
- Light weight
- Silent
- No pulsation air flow
- Quick response air flow

Applications

- Gene analyzer
- Gas (breath) sensing instrument
- Blood pressure monitor
- Breast pump
- Negative pressure wound therapy

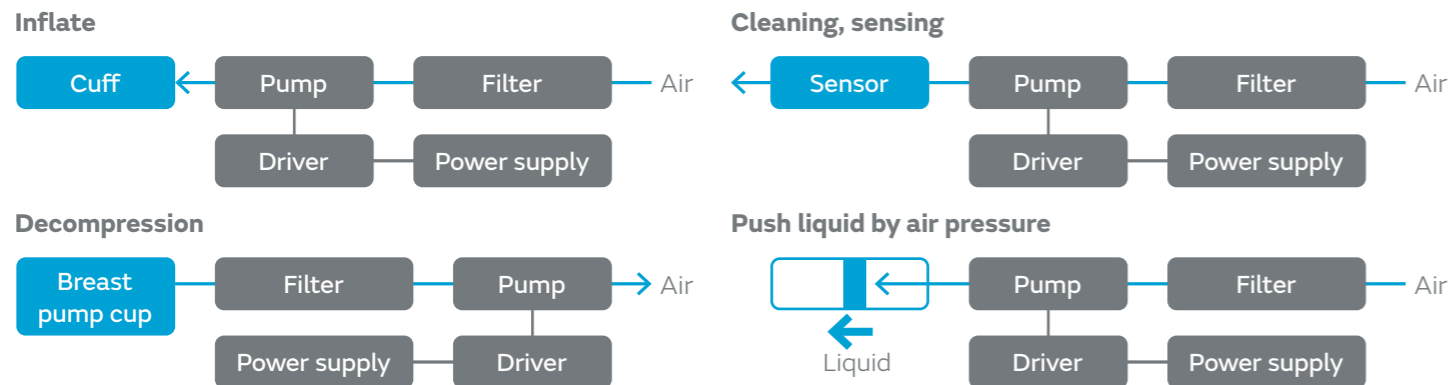

Please contact Murata sales before using our products for Medical applications which require especially high reliability for the prevention of defects which might directly cause damage to the third party's life, body or property.

Find out more >

Limitation of Applications

CAUTION

Limitation of Applications

The products listed in the catalog (hereinafter the product(s) is called as the "Product(s)") are designed and manufactured for applications specified in the catalog. (hereinafter called as the "Specific Application").

We shall not warrant anything in connection with the Products including fitness, performance, adequateness, safety, or quality, in the case of applications listed in from (1) to (10) written at the end of this precautions, which may generally require high performance, function, quality, management of production or safety. Therefore, the Product shall be applied in compliance with the specific application.

WE DISCLAIM ANY LOSS AND DAMAGES ARISING FROM OR IN CONNECTION WITH THE PRODUCTS INCLUDING BUT NOT LIMITED TO THE CASE SUCH LOSS AND DAMAGES CAUSED BY THE UNEXPECTED ACCIDENT, IN EVENT THAT (i) THE PRODUCT IS APPLIED FOR THE PURPOSE WHICH IS NOT SPECIFIED AS THE SPECIFIC APPLICATION FOR THE PRODUCT, AND/OR (ii) THE PRODUCT IS APPLIED FOR ANY FOLLOWING APPLICATION PURPOSES FROM (1) TO (10) (EXCEPT THAT SUCH APPLICATION PURPOSE IS UNAMBIGUOUSLY SPECIFIED AS SPECIFIC APPLICATION FOR THE PRODUCT IN OUR CATALOG SPECIFICATION FORMS, DATASHEETS, OR OTHER DOCUMENTS OFFICIALLY ISSUED BY US*).

- (1) Aircraft equipment
- (2) Aerospace equipment
- (3) Undersea equipment
- (4) Power plant control equipment
- (5) Transportation equipment
- (6) Traffic control equipment
- (7) Disaster prevention/security equipment
- (8) Industrial data-processing equipment
- (9) Combustion/explosion control equipment
- (10) Equipment with complexity and/or required reliability equivalent to the applications listed in the above.

For exploring information of the Products which will be compatible with the particular purpose other than those specified in the catalog, please contact our sales offices, distribution agents, or trading companies with which you make a deal, or via our web contact form.

Contact form: <https://www.murata.com/contactform>

**We may design and manufacture particular Products for applications listed in (1) to (10). Provided that, in such case we shall unambiguously specify such Specific Application in the catalog without any exception. Therefore, any other documents and/or performances, whether exist or non-exist, shall not be deemed as the evidence to imply that we accept the applications listed in (1) to (10).*