

TOSHIBA

Microcontrollers

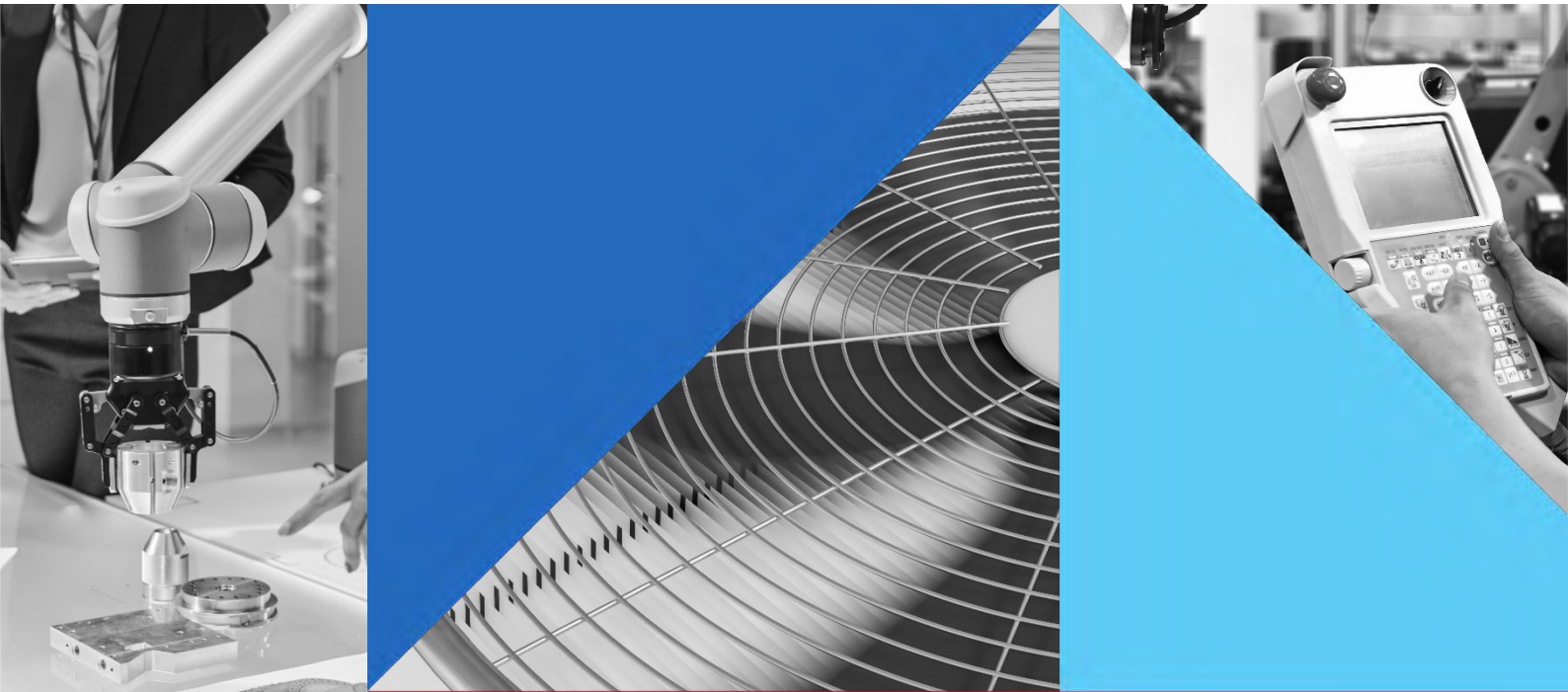

TXZ+™

32-bit
Microcontroller
Family

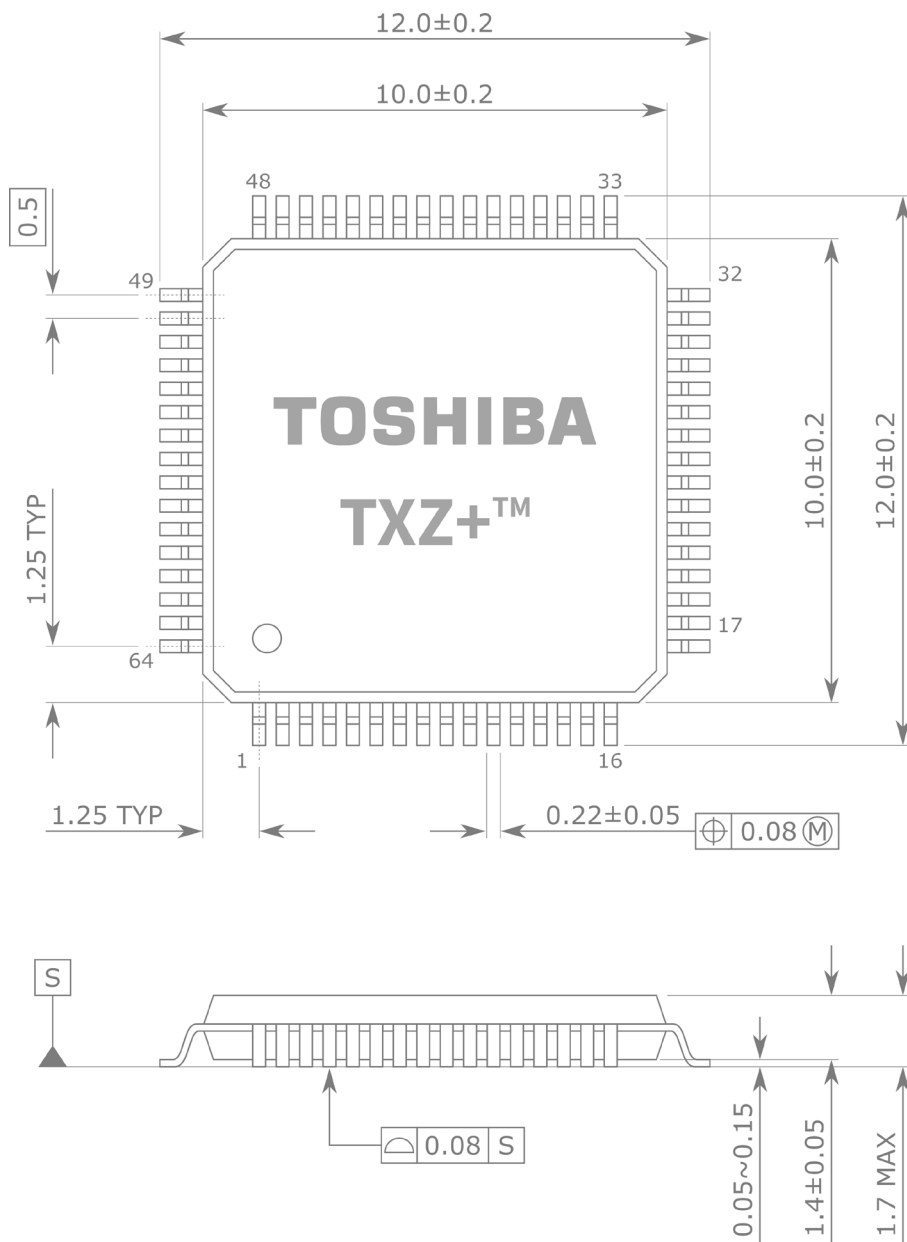

Content

TXZ+™ Microcontroller Family Overview	3 – 5
Functional Safety and Long Term Supply	6
M4K/M4M – Advanced Motor Control	7 – 9
M4G/M4N – Complex Data Processing and Communication	10 – 12
M3H – General Sensing and Control	13 – 15
Application Support	16 – 17
Ordering Information	18

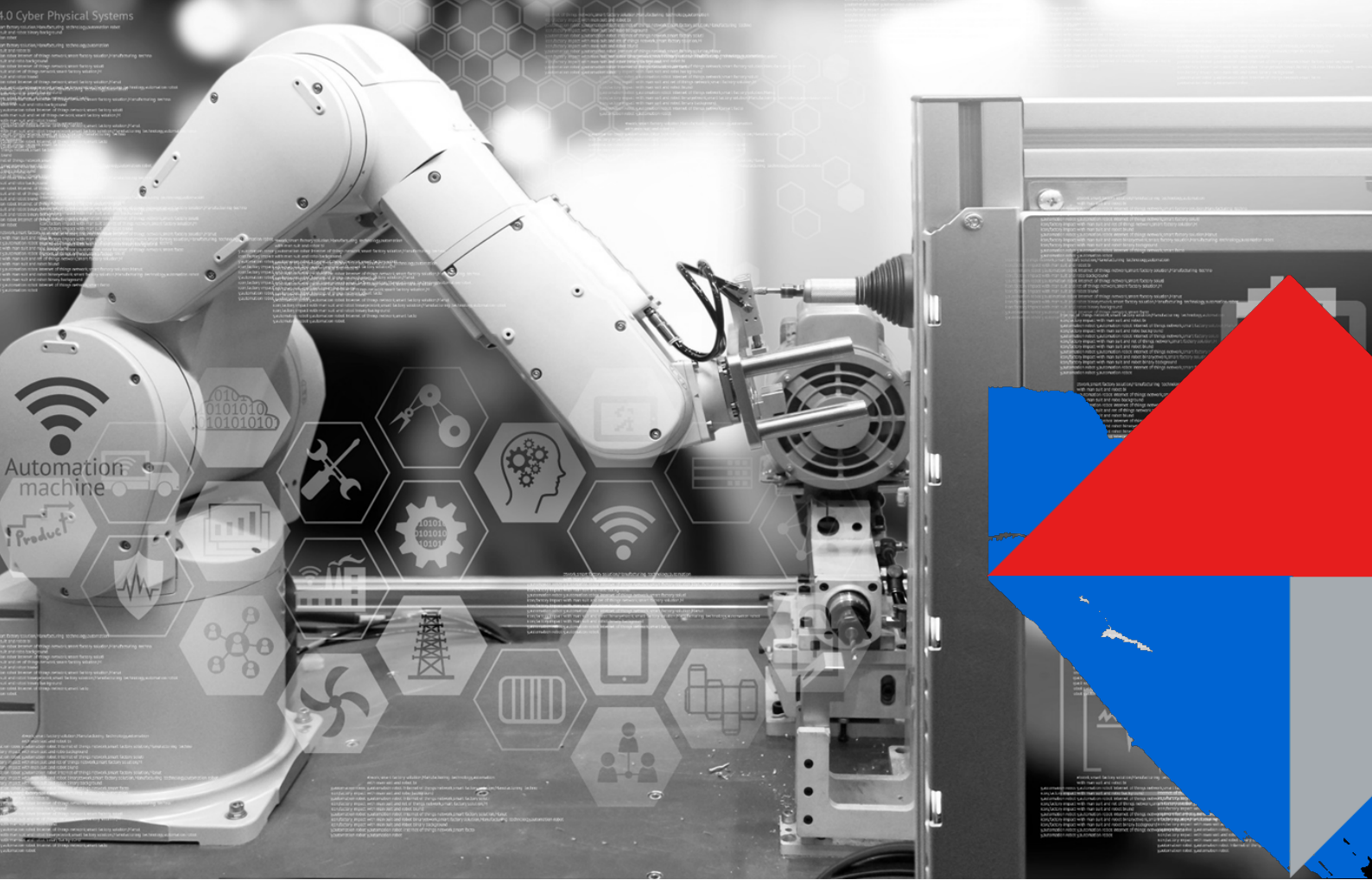

TXZ+™

32-Bit Microcontroller Family

Optimal performance and scalability

Toshiba's TXZ+™ microcontroller family combines experience with excellence and takes performance to the next level. Manufactured in a 40 nm CMOS process and equipped with 32-bit Arm® Cortex® processor cores, the devices consume approximate 30% less power than Toshiba's previous microcontroller generation.

Complementary Toshiba original IP together with various useful peripheral functions provide added value for multi-axis motor control and data processing applications, increase system performance, and reduce software development effort.



M4K
group

M4M
group

Advanced Motor Control

Arm® Cortex® M4 with FPU, operating up to 160 MHz at an extended temperature range from -40°C to 105°C. Featuring Toshiba original motor control IP enabling both, sensed and sensorless Field Oriented Control (FOC) of up to three BLDC motors by a single MCU device.



M4G
group

M4N
group

Data Processing and Communication

Arm® Cortex® M4 with FPU, operating up to 200 MHz with integrated flash memory up to 2 MB. Various interfaces including integrated USB2.0 FS OTG and 10/100 Ethernet MAC provide a wide variety of connectivity options.

M3H
group

General Sensing and Control

Arm® Cortex® M3, operating up to 120 MHz. Featuring Toshiba original motor control IP for basic Field Oriented Control (FOC) and integrated digital LCD drivers.





TXZ+™ Family Microprocessors at a Glance



Features

- 32-bit Arm® Cortex®-M3 / -M4 processor core operating up to 200 MHz
- 128 KB – 2048 KB code flash, 32 KB data flash, 4 KB user info flash
- 100k write cycles flash endurance
- 24 KB – 258 KB SRAM
- Max. 3 units of 12-bit A/D converters with integrated operation amplifiers⁽¹⁾
- Advanced Vector Engine+⁽¹⁾
- Advanced Programmable Motor Driver (A-PMD)
- 32-bit Encoder Input⁽²⁾
- USB2.0 OTG incl. PHY and 10/100 Ethernet MAC⁽³⁾



Advantages

- State of the art 40 nm low-power CMOS process
- Wide lineup with 80+ products
- Highly scalable microcontroller devices
- Toshiba's original motor control IP
- Low effort and high efficient field oriented motor control (FOC)
- Integrated functions supporting both functional safety and security



Benefits

- Low operating and standby current
- Improved thermal performance
- Platform design with re-use of software and PCB topology
- Energy efficient Field Oriented Control (FOC) of up to three motors by a single MCU device
- Support of both sensed and sensorless motor control
- Low effort software development
- Long term supply: min. 15 years after start of production



Applications

- Basic and advanced motor control / Field Oriented motor Control (FOC)
- Robots, Cobots, mobile robots and AGVs
- Industrial and building automation
- Heating, ventilation, air condition (HVAC)
- Variable frequency drives
- Home appliances
- Office equipment

⁽¹⁾ M4K and M4M product groups

⁽²⁾ M3H, M4K and M4M product groups

⁽³⁾ M4N product group

Functional Safety

The TXZ+™ microcontroller family devices feature a variety of internal functions such as low voltage detection, oscillator and clock frequency detection, cyclic redundancy check⁽¹⁾, SRAM parity⁽¹⁾ and others, supporting the design of products compliant to various functional safety norms including IEC 61508 and IEC 60730 Class B.

Toshiba offers a set of software library functions that make use of the TXZ+™ safety features to perform periodical self-test of fundamental hardware functions in compliance with IEC 60730 Class B. Software library, sample code and application notes are available for download on the Toshiba semiconductor internet page.

⁽¹⁾ M3H, M4K and M4M product groups

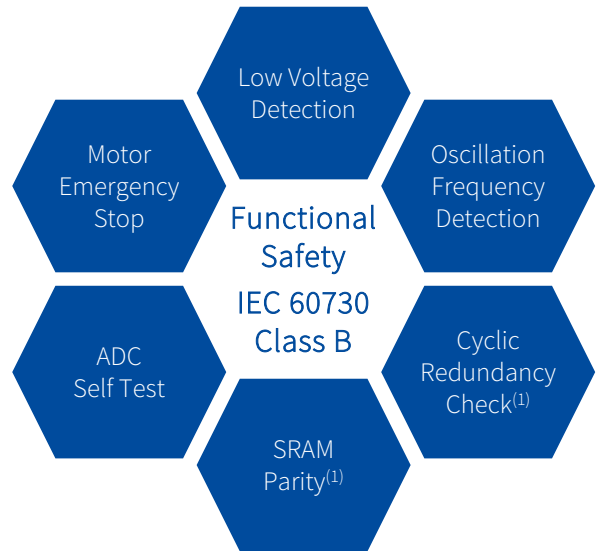

Long Term Supply



Toshiba Electronic Devices & Storage Corporation (TDSC) and its subsidiaries and affiliates will continue to focus on the development, manufacture, and sale of semiconductor products in the automotive and industrial markets.

With the aim of ensuring that our semiconductor products continue to be adopted by customers whose products have long life cycles, it is our intention to support the supply of our designated products for automotive and industrial markets for fifteen years from the start of our production.





Advanced Motor Control

The devices of the M4K and M4M groups are optimized for advanced sensed or sensorless Field Oriented Control (FOC) of up to three BLDC motors by a single microcontroller device. They feature an Arm® Cortex®-M4 processor core with FPU operating up to 160 MHz, complemented by Toshiba's original motor control IP and other feature rich peripherals.

The devices come with an integrated 128 – 256 KB code flash and a separated 32 KB data flash, both supporting 100k write cycles endurance. The extended operating temperature range up to 105°C and the integrated safety and security functions make them most suitable for a wide variety of advanced motor control applications.

M4K
group

M4M
group

Toshiba original motor control IP

Vector Engine

M4K and M4M devices include Toshiba’s original Advanced Vector Engine Plus (A-VE+), a high performant coprocessor executing the complex operations required for Field Oriented Control (FOC). It frees up valuable computational resources allowing the processor core to take care of other tasks such as Power Factor Correction (PFC), sensing operations or system communication in parallel. When controlling multiple motors, the Vector Engine notably reduces FOC execution time. The frequency of the processor core can be decreased having positive impacts on power, heating, EMC and system cost. The Vector Engine also comes with a flexible scheduler allowing the user to optimize the interaction between the Vector Engine and the software running on the main processor core.

Programmable Motor Driver

M4K and M4M devices include up to three instances of Advanced Programmable Motor Driver (A-PMD), a versatile hardware circuit for the generation of the complementary 3-phase motor PWM output towards the external inverter circuit. It supports multiple PWM carrier waveforms, individually selectable for each single motor phase – a feature that is the key to advanced motor control techniques. The A-PMD also includes motor protection and dead time control circuits, and it generates the trigger for the A/D converters for a precise measurements of the phase currents with adjustable timing synchronized to the selected PWM carrier.

Encoder Circuit

The devices of the M4K and M4M groups also feature up to three instances of the 32-bit Advanced Encoder Circuit (A-ENC32) that can be used to read out rotor positions from 2-phase and 3-phase Hall sensors or AB- and ABZ-type incremental encoders.

12-bit A/D Converters with internal operation amplifiers

The M4K and M4M microcontroller group include up to three instances of 12-bit Analog-to-Digital Converters (ADC) with a maximum of 22 analog input channels and a conversion time of 1 μ s, complemented by three units of operation amplifiers with programmable gain.

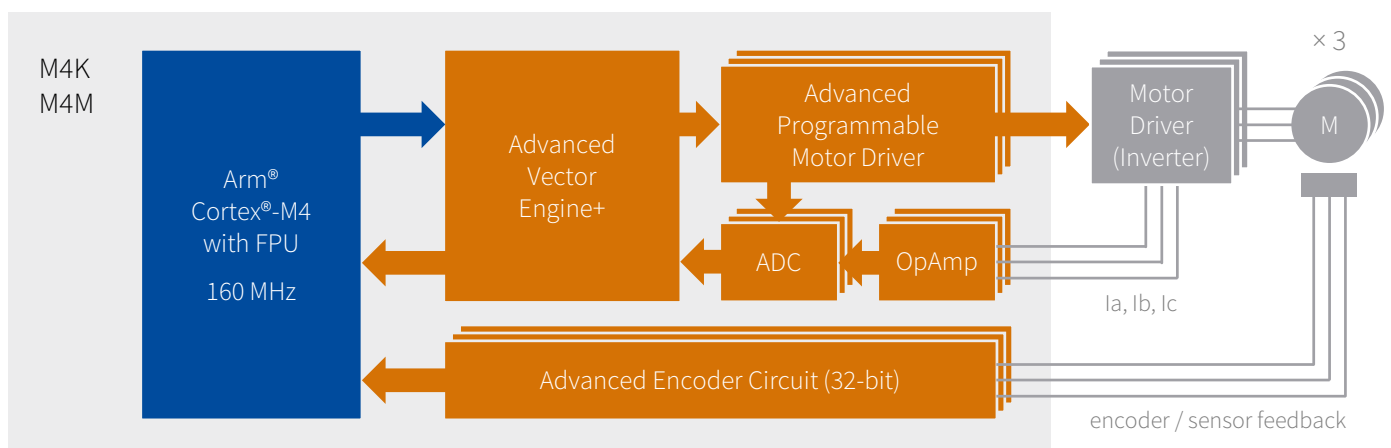

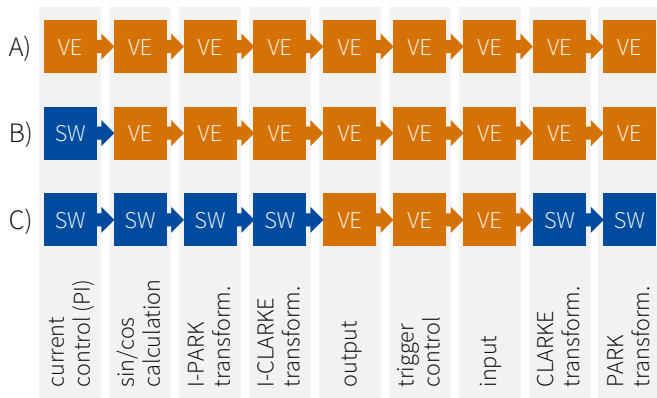

- A) Complete motor control executed by Vector Engine
- B) Current Control executed by software
- C) Only I/O and trigger control executed by Vector Engine

The **Vector Engine** coprocessor comes with a flexible task scheduler optimizing the interaction with the processor.

Single motor control

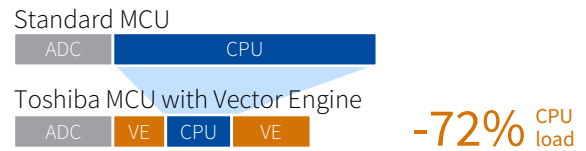

Dual motor control

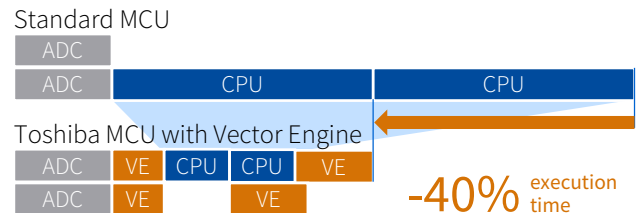

The **Vector Engine** significantly reduces CPU load and execution time for single and multi-axis motor control.

		M4KH	M4KL / M4ML	M4KM / M4MM	M4KN / M4MN		
Processor core	CPU	Arm® Cortex®-M4 with FPU					
	Max. Freq.	160 MHz					
System	Code Flash	128 / 256 KB					
	Data Flash	32 KB					
	User Information Flash	4 KB					
	SRAM	24 KB					
	DMAC (unit / ch)	1 / 26	1 / 30	1 / 32	1 / 32		
	Ext. Interrupts	8	15	18	20		
	RTC	-	-	-	-		
	Timer (16-bit / 32-bit)	12 / 6	12 / 6	12 / 6	12 / 6		
	PWM (16-bit / 32-bit)	7 / 5	9 / 5	10 / 6	11 / 6		
	WDT	●	●	●	●		
Analog	12-bit ADC (unit / ch / conv.)	2 / 6,2 / 1.0 us	3 / 8,3,3 / 1.0 us	3 / 8,5,4 / 1.0 us	3 / 11,5,6 / 1.0 us		
	Operation Amplifier (units)	3	3	3	3		
	Comparator (units)	-	-	-	-		
	8-bit DAC (ch)	-	-	-	-		
Motor control	Vector Engine (type)	A-VE+	A-VE+	A-VE+	A-VE+		
	PMD (unit × type)	1 × A-PMD	3 × A-PMD	3 × A-PMD	3 × A-PMD		
	Encoder Input (unit / type)	-	1 × A-ENC32	2 × A-ENC32	3 × A-ENC32		
Interfaces	IO Pins	31	51	67	87		
	UART	3	3	4	4		
	I2C	1	2	2	2		
	SPI	1	2	2	2		
	SIO	1	2	2	2		
	CAN	-	- / 1	- / 1	- / 1		
Package	Package Code	UG	UG	FG	FG	DFG	
	Type / Pins	LQFP 44	LQFP 64	LQFP 64	LQFP 80	LQFP 100	
	Dimension (W×L) [mm]	10×10	10×10	14×14	12×12	14×14	
	Pitch [mm]	0.80	0.50	0.80	0.50	0.65	
Operating conditions	Power Supply	4.5 V – 5.5 V (without ADC: 2.7 V – 5.5 V)					
	Operating Temperature	-40°C – 105°C					

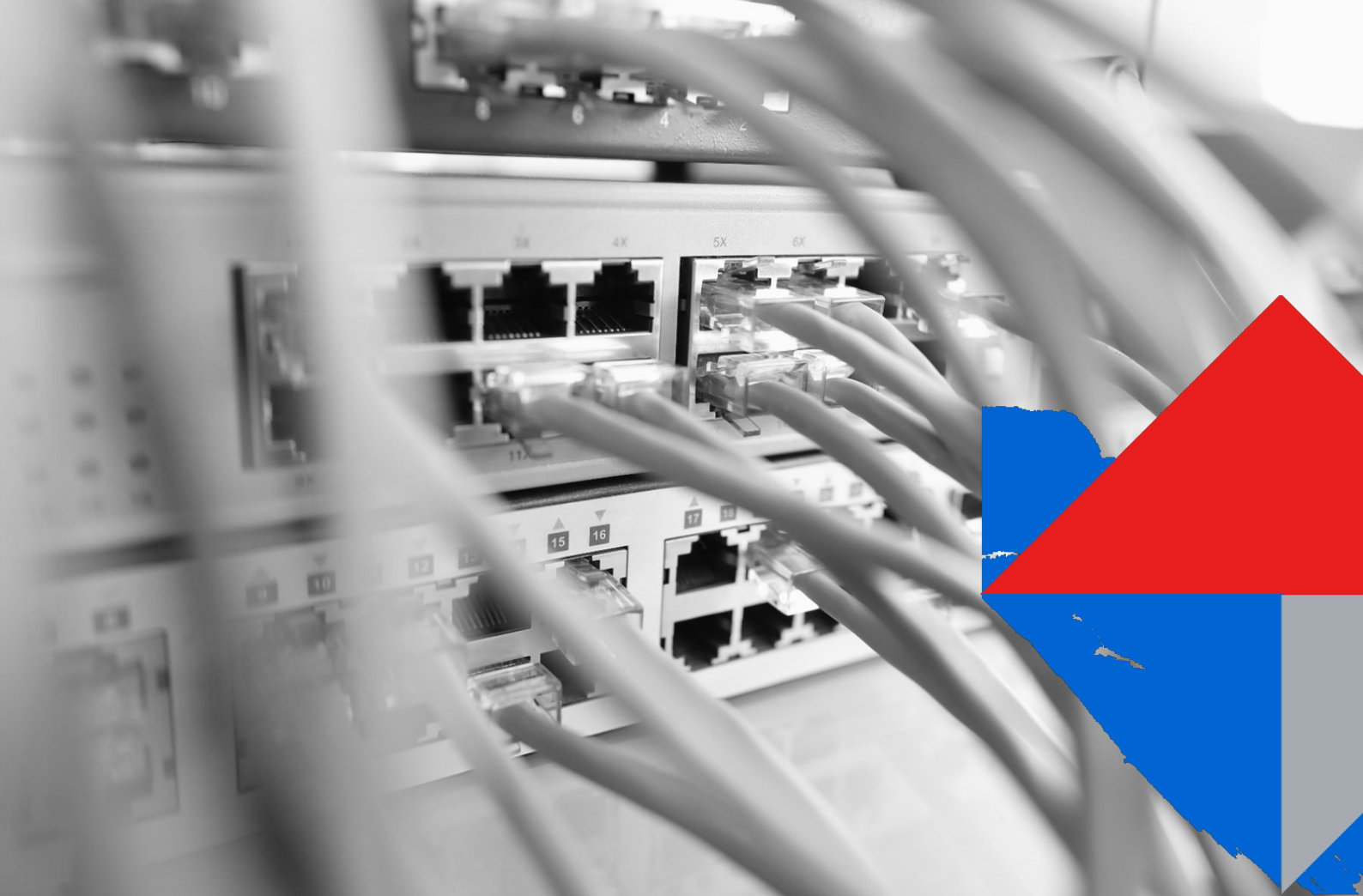

Complex Data Processing and Communication

M4G
group

The microcontroller devices of the M4G and M4N groups target central control applications requiring intensive data processing and interface rich communication. The devices include an Arm® Cortex®-M4 processor core with FPU operating up to 200 MHz and up to 256 KB of SRAM.

M4N
group

MCU devices of both groups feature a large integrated flash memory of 512 – 2048 KB for code storage plus additional 32 KB for data storage. A dedicated and secured 4 KB user information flash is available to hold device specific information and authentication certificates. All flash memories support 100k write cycles endurance.

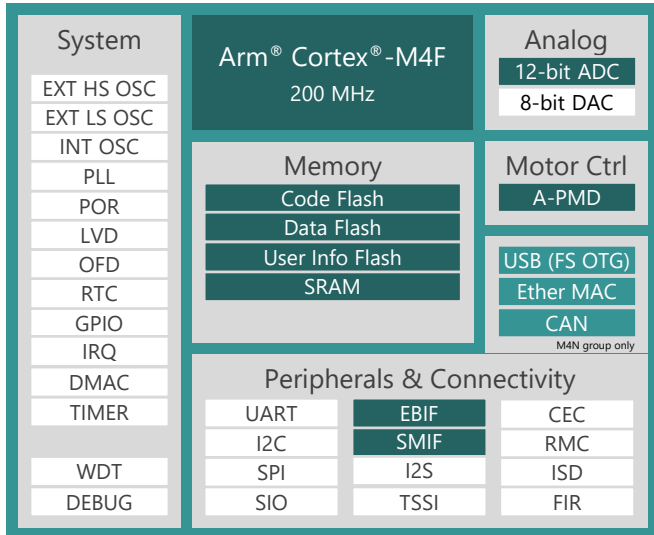

Besides a 12-bit ADC with up to 24 input channels and 1 μ s conversion time, the devices contain two units of 8-bit DAC and an Advanced Programmable Motor Driver (A-PMD) unit that can be used to perform general motor control or Power Factor Correction (PFC) operations.

Various interfaces including External Bus Interface (EBIF), Serial Memory Interface (SMIF), Inter-IC Sound (I2S), Timer Synchronization Service Interface (TSSI), Consumer Electronics Control (CEC) and others provide a wide variety of connectivity options.

		M4GN	M4GQ	M4GR		
Processor core	CPU	Arm® Cortex®-M4 with FPU				
	Max. Freq.	200 MHz				
System	Code Flash	512 / 1024 / 1536 / 2048 KB				
	Data Flash	32 KB				
	User Information Flash	4 KB				
	SRAM	194 / 258 KB				
	DMAC (unit / ch)	3 / 43	3 / 47	3 / 47		
	Ext. Interrupts	12	16	16		
	RTC	●	●	●		
	Timer (16-bit / 32-bit)	32 / 16	32 / 16	32 / 16		
	Long Term Timer	1	1	1		
	WDT	●	●	●		
Analog	12-bit ADC (unit / ch / conv.)	1 / 16 / 1.0 μ s	1 / 24 / 1.0 μ s	1 / 24 / 1.0 μ s		
	Operation Amplifier (units)	-	-	-		
	Comparator (units)	-	-	-		
	8-bit DAC (ch)	2	2	2		
Motor control	Vector Engine (type)	-	-	-		
	PMD (unit \times type)	1 \times A-PMD	1 \times A-PMD	1 \times A-PMD		
	Encoder Input (unit / type)	-	-	-		
Interfaces	IO Pins	91	127	155		
	UART	4	7	8		
	I2C	3	5	5		
	SPI	5	8	9		
	SIO	5	8	9		
	CAN (ch)	-	-	-		
	USB FS OTG (unit)	-	-	-		
	10/100 Ethernet MAC (unit)	-	-	-		
Others	EBIF, SMIF, I2S (2), TSSI, CEC, RMC, ISD, FIR Filter					
Package	Package Code	FG	FG	XBG	FG	XBG
	Type / Pins	LQFP 100	LQFP 144	VFBGA 145	LQFP 176	VFBGA 177
	Dimension (W \times L) [mm]	14 \times 14	20 \times 20	12 \times 12	20 \times 20	13 \times 13
	Pitch [mm]	0.50	0.50	0.80	0.40	0.80
Operating conditions	Power Supply	2.7 V – 3.6 V				
	Operating Temperature	-40°C – 85°C				

The microcontroller devices of the M4N group add even more connectivity options: A two-channel CAN controller allows the devices to be directly connected to the popular field bus.

The USB2.0 Full-Speed On-The-Go (OTG) controller with integrated PHY ensures a straightforward connection to external peripherals either in host, device or OTG mode, and the integrated 10/100 Ethernet MAC enables an immediate access to Ethernet networks through an external Ethernet PHY connected to the MII or RMI interface.

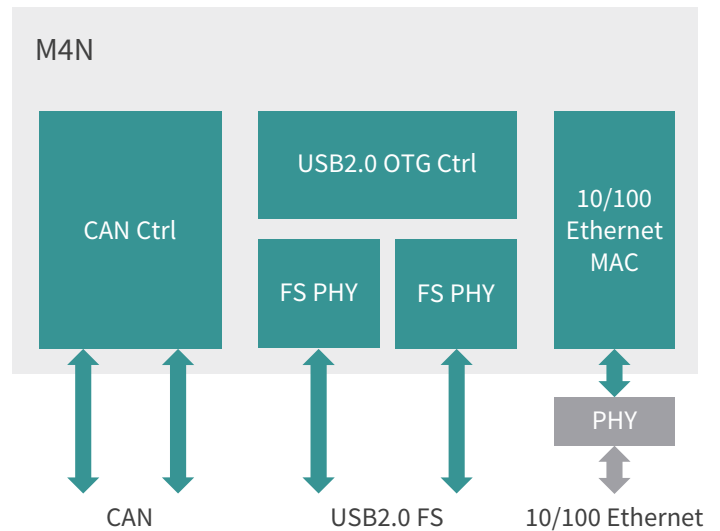

		M4NN	M4NQ		M4NR	
Processor core	CPU	Arm® Cortex®-M4 with FPU				
	Max. Freq.	200 MHz (using USB: 192 MHz)				
System	Code Flash	512 / 1024 / 1536 / 2048 KB				
	Data Flash	32 KB				
	User Information Flash	4 KB				
	SRAM	194 / 258 KB				
	DMAC (unit / ch)	3 / 43	3 / 47		3 / 47	
	Ext. Interrupts	9	14		16	
	RTC	●	●		●	
	Timer (16-bit / 32-bit)	32 / 16	32 / 16		32 / 16	
	Long Term Timer	1	1		1	
	WDT	●	●		●	
Analog	12-bit ADC (unit / ch / conv.)	1 / 16 / 1.0 us	1 / 24 / 1.0 us		1 / 24 / 1.0 us	
	Operation Amplifier (units)	-	-		-	
	Comparator (units)	-	-		-	
	8-bit DAC (ch)	2	2		2	
Motor control	Vector Engine (type)	-	-		-	
	PMD (unit × type)	1 × A-PMD	1 × A-PMD		1 × A-PMD	
	Encoder Input (unit / type)	-	-		-	
Interfaces	IO Pins	86	118		146	
	UART	4	7		8	
	I2C	3	5		5	
	SPI	5	8		9	
	SIO	5	8		9	
	CAN (ch)	2	2		2	
	USB FS OTG (unit)	1	2		2	
	10/100 Ethernet MAC (unit)	1 (MII/RMII)				
Others	EBIF, SMIF, I2S (2), TSSI, CEC, RMC, ISD, FIR Filter					
Package	Package Code	FG	FG	XBG	FG	XBG
	Type / Pins	LQFP 100	LQFP 144	VFBGA 145	LQFP 176	VFBGA 177
	Dimension (W×L) [mm]	14 × 14	20 × 20	12 × 12	20 × 20	13 × 13
	Pitch [mm]	0.50	0.50	0.80	0.40	0.80
Operating conditions	Power Supply	2.7 V – 3.6 V (using USB: 3.0 V – 3.6 V)				
	Operating Temperature	-40°C – 85°C				

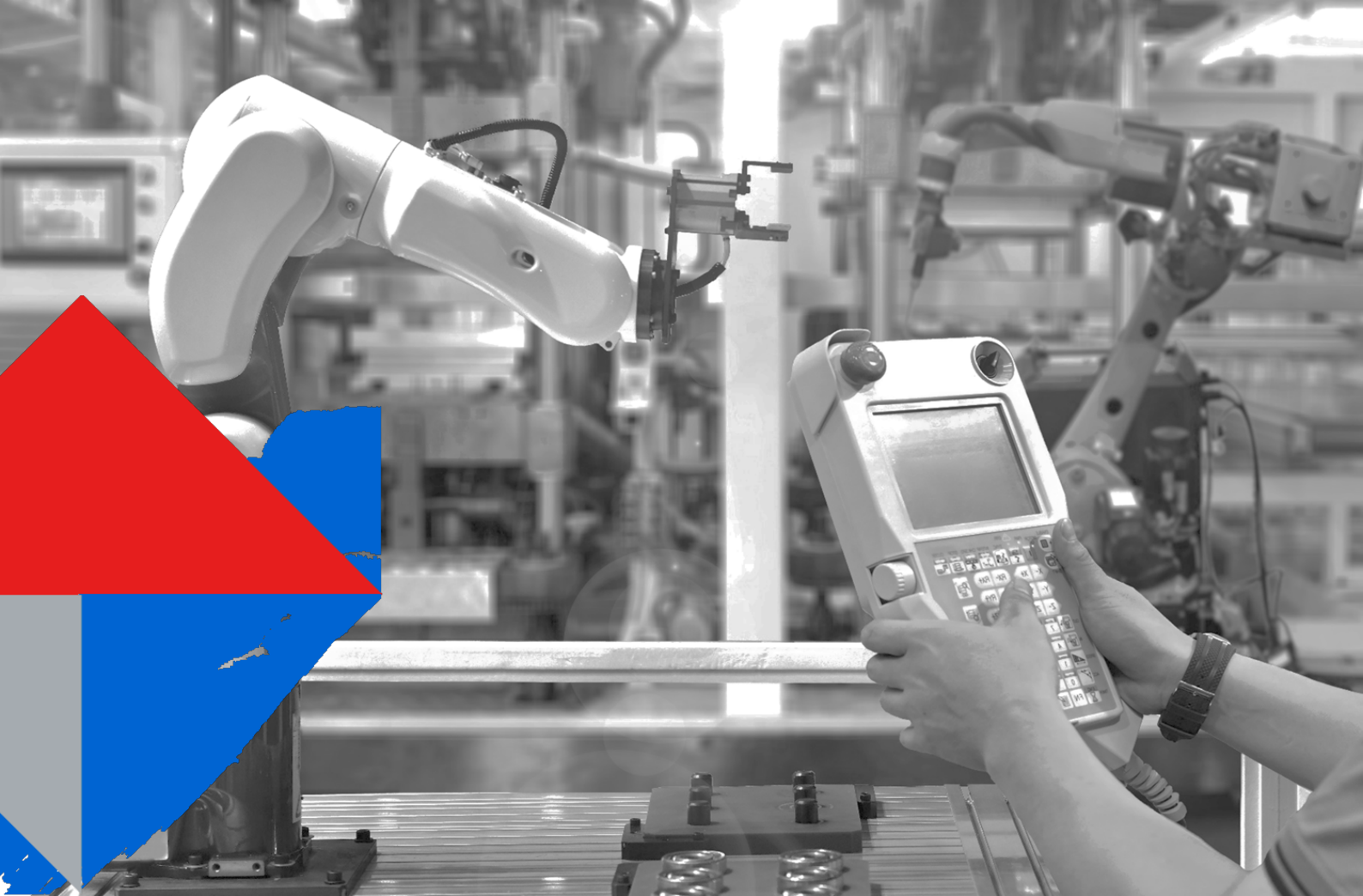

General Sensing and Control

The devices of the M3H microcontroller group are most suited for basic motor operation and for general sensing and control applications. They include an Arm® Cortex® M3 processor core operating up to 120 MHz and 64 KB of SRAM plus 2 KB of backup RAM. Their integrated flash memory can store 256 KB – 512 KB of code and additional 32 KB of data with 100k write cycles endurance.

The devices feature a 12-bit A/D converter with a maximum of 21 analog input channels, 2 channel 8-bit D/A converter, and an integrated digital LCD driver circuit capable of driving LCDs up to 4 com × 40 seg. The wide supply range of 2.7 – 5.5 V and the extended operating temperature range up to 105°C make the M3H group very attractive for a broad range of applications including home appliances, consumer and industrial equipment, and generic motor control.

M3H
group

Toshiba original motor control IP

Programmable Motor Driver

Encoder Circuit

The M3H devices include Toshiba’s original motor control IP enabling hassle-free motor operation.

The Advanced Programmable Motor Driver (A-PMD) is a versatile hardware circuit for the generation of the complementary 3-phase motor PWM output towards the external inverter circuit. It supports multiple PWM carrier waveforms, individually selectable for each single motor phase – a feature that is the key to advanced motor control techniques. The A-PMD also includes motor protection and dead time control circuits, and it generates the trigger for the A/D converters for a precise measurements of the phase currents with adjustable timing synchronized to the selected PWM carrier.

The 32-bit Advanced Encoder Circuit (A-ENC32) connects directly to Hall sensors or to incremental encoders and thus allows to track the motor position in a convenient and accurate way. It supports 2-phase and 3-phase Hall sensors as well as AB-type or ABZ-type incremental encoders.

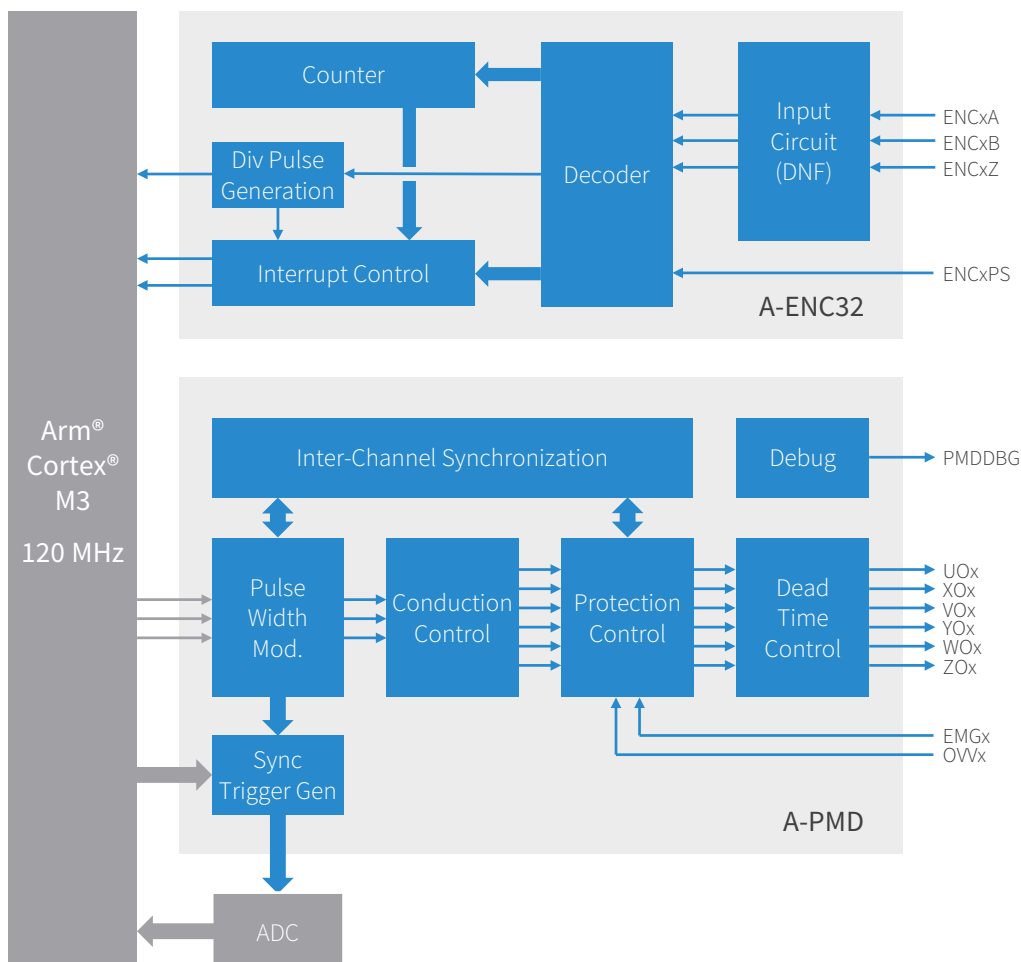

Toshiba’s **Advanced 32-bit Encoder Circuit (A-ENC32)** connects to external Hall sensors or incremental encoders.

Toshiba’s **Advanced Programmable Motor Driver Circuit (A-PMD)** performs pulse width modulation (PWM), conduction, protection and dead time control, and triggers the synchronous A/D conversion.

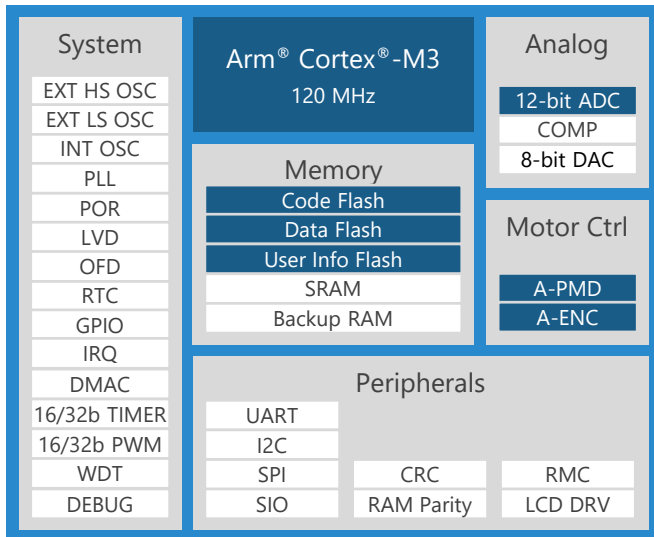

Besides a 12-bit ADC with up to 24 input channels and 1 μ s conversion time, the devices contain two units of 8-bit DAC and an Advanced Programmable Motor Driver (A-PMD) unit that can be used to perform general motor control or Power Factor Correction (PFC) operations.

Various interfaces including External Bus Interface (EBIF), Serial Memory Interface (SMIF), Inter-IC Sound (I2S), Timer Synchronization Service Interface (TSSI), Consumer Electronics Control (CEC) and others provide a wide variety of connectivity options.

		M3HL	M3HM	M3HN	M3HP	M3HQ		
Processor core	CPU	Arm® Cortex®-M3						
	Max. Freq.	120 MHz						
System	Code Flash	256 / 384 / 512 KB						
	Data Flash	32 KB						
	User Info Flash	4 KB						
	SRAM	66 KB						
	DMAC (unit / ch)	2 / 54	2 / 62	2 / 62	2 / 64	2 / 64		
	Ext. Interrupts	12	15	19	31	34		
	RTC	●	●	●	●	●		
	Timer (16-bit / 32-bit)	16 / 8	16 / 8	16 / 8	16 / 8	16 / 8		
	PWM (16-bit / 32-bit)	12 / 6	12 / 6	14 / 7	16 / 8	16 / 8		
	WDT	●	●	●	●	●		
Analog	12-bit ADC (unit / ch / conv.)	1 / 12 / 1.0 μ s	1 / 12 / 1.0 μ s	1 / 17 / 1.0 μ s	1 / 19 / 1.0 μ s	1 / 21 / 1.0 μ s		
	Operation Amplifier (units)	-	-	-	-	-		
	Comparator (units)	1	1	1	1	1		
	8-bit DAC (ch)	2	2	2	2	2		
Motor control	Vector Engine (type)	-	-	-	-	-		
	PMD (unit \times type)	1 \times A-PMD	1 \times A-PMD	1 \times A-PMD	1 \times A-PMD	1 \times A-PMD		
	Encoder Input (unit / type)	1 \times A-ENC	1 \times A-ENC	1 \times A-ENC	1 \times A-ENC	1 \times A-ENC		
Interfaces	IO Pins	57	73	93	119	135		
	UART	7	7	8	8	8		
	I2C	2	3	3	4	4		
	SPI	1	4	4	5	5		
	SIO	1	4	4	5	5		
	Others	-	LCD (4 \times 26)	LCD (4 \times 32)	LCD (4 \times 40)	LCD (4 \times 40)		
Package	Package Code	UG	FG	FG	DFG	FG	DFG	FG
	Type / Pins	LQFP 64	LQFP 80	LQFP100	QFP100	LQFP128	QFP128	LQFP 144
	Dimension (W \times L) [mm]	10 \times 10	12 \times 12	14 \times 14	14 \times 20	14 \times 14	14 \times 20	20 \times 20
	Pitch [mm]	0.50	0.50	0.50	0.65	0.40	0.50	0.50
Operating conditions	Power Supply	2.7 V – 5.5 V						
	Operating Temperature	-40°C – 105°C						



Application Support

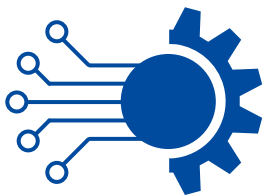

At Toshiba we understand that providing excellent microcontroller hardware is only one part of the entire solution. Our highly skilled engineers in local application support centers around the world will assist you with hardware selection, evaluation boards, associated driver and sample software, and complete reference designs for key applications.

Evaluation boards and reference models

Toshiba offers a wide variety of boards for the evaluation of its microcontroller products – from simple break out boards over sophisticated evaluation boards and starter kits to complex reference models.

The new Servo Drive Reference Model (RM) gives a quick start to developers realizing advanced motor systems. It combines Toshiba's optimized motor control MCU with Toshiba's low RDS(ON) Power MOSFETs providing high efficient control and drive solutions for brushless DC (BLDC) motors. The modular concept offers highest flexibility for Field-Oriented Control (FOC) and closed-loop positioning of up to three BLDC motors by a single MCU resulting in reduced system cost.

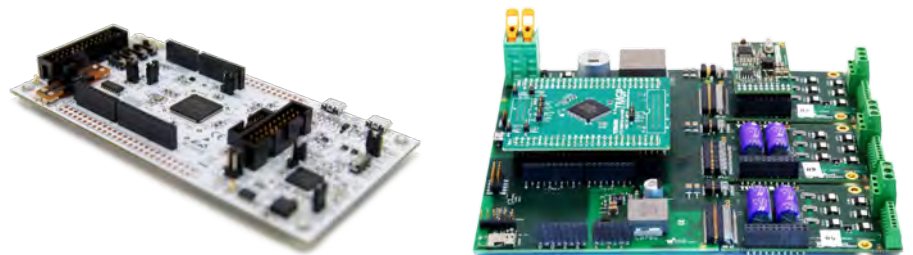

Software support

All Toshiba microcontrollers come with CMSIS compliant drivers and ready to go software libraries for industry favored Integrated Development Environments (IDE) such as Arm KEIL, IAR Systems Embedded Workbench and Segger Embedded Studio.

Toshiba also supports a wide variety of debuggers and flash programming tools. Sample software for many applications is available for download on Toshiba's semiconductor website.



Sensorless motor control software technology

Toshiba's patented Sensorless Low-Noise technology is capable of estimating the rotor position and applying FOC even at zero or low rotation speed, resulting in a silent motor start up suitable for quiet environments.

The Sensorless High-Torque technology, primarily developed for cord less power tools, is able to maintain the rotation speed even at increased load conditions, e.g. when drilling into solid materials.

Sensor-Less Precise-Positioning is the technology to be used when motors need to be driven to a specific angle (e.g. for cobots, AMR, mowers, cleaning robots).

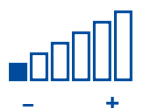

Ordering Information



Example **TMP M4 K L FY A UG**

Product identifier

TMP = Toshiba microprocessor

Processor core

M3 = Arm® Cortex®-M3

M4 = Arm® Cortex®-M4 with FPU

Device group

H = general sensing and control devices

K = advanced motor control devices w/o CAN I/F

M = advanced motor control devices with CAN I/F

G = complex data processing devices

N = communication devices with USB2.0 and 10/100 Ethernet

Pin count

H = 44 pins

P = 128 pins

L = 64 pins

Q = 144/145 pins

M = 80 pins

R = 176/177 pins

N = 100 pins

Internal flash size (code flash)

FW = 128 KB

F10 = 1024 KB

FY = 256 KB

F15 = 1536 KB

FZ = 384 KB

F20 = 2048 KB

FD = 512 KB

Product revision

(blank) = initial revision

A = 2nd revision

B = 3rd revision

Package type

UG = LQFP with max. 10×10 mm size

FG = LQFP with max. 20×20 mm size

DFG = QFP with rectangular form factor

XBG = Fine-pitch plastic BGA

For further information please contact our local sales office or visit <https://toshiba.semicon-storage.com/eu/contact.html>

TOSHIBA

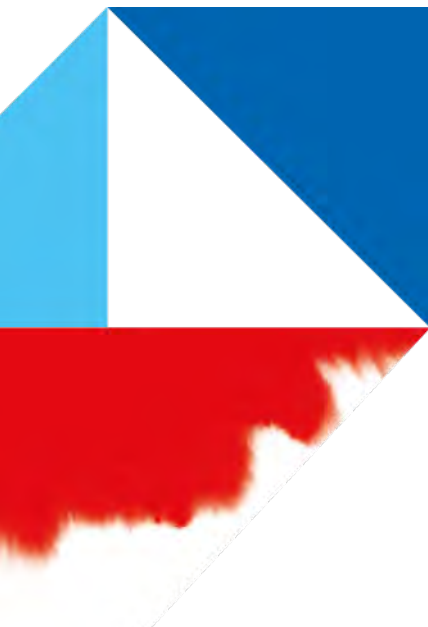

Toshiba Electronics Europe GmbH
Hansaallee 181
40549 Düsseldorf, Germany

Further information
toshiba.semicon-storage.com

Copyright 2022 Toshiba Electronics Europe GmbH. Product specifications are all subject to change without notice. Product design specifications and colours are subject to change without notice and may vary from those shown.

Arm and Cortex are registered trademarks of Arm Limited (or its subsidiaries) in the US and/or elsewhere.

TXZ+ is a trademark of Toshiba Electronic Devices & Storage Corporation.

Errors and omissions excepted. Valid from 02/2022.