



Data Sheet

AS03604MR-N50-R

Introducing the N50 Mini Speaker Series from PUI Audio. High-grade neodymium magnetic motors are employed in each N50 Series speaker to create the highest output possible, in the smallest form factor.

A black poly dome-capped paper diaphragm combines with a rubber surround for moisture resistance on the 36mm diameter **AS03604MR-N50-R**. High power handling (conservatively rated at 5 watts, 6 watts peak) is achieved through the use of a cupped spider.

Features:

- Black poly cone and rubber surround
- High 85 dB output at 1W/50cm
- N50 neodymium motor
- Only 17.5mm thick
- 2.5mm of excursion

Specifications

Parameters	Values	Units
Rated Input Power	3	Watts
Max Input Power	5	Watts
Impedance	4 ± 15%	Ohms
Sensitivity (SPL @ 1W/50cm) (800, 1000, 1200, and 1500 Hz)	85 ± 3	dBA
Distortion (Max @ 1W, 1 kHz)	<5%	
Resonant Frequency	200 ± 20%	Hz
Frequency Range	150 ~ 20,000	Hz
Housing Material	ABS	
Magnet Material	NdFeB	
Weight	20.2	Grams

Specifications (continued)

Buzz, Rattle, etc.	Should not be audible with 4.47Vpk sine wave from 200 Hz to 20 kHz	
Polarity	When positive voltage is applied to the positive terminal, the diaphragm will move outward	
Operating Temperature	-20 ~ +50	°C
Storage Temperature	-30 ~ +60	°C

Measurement Method

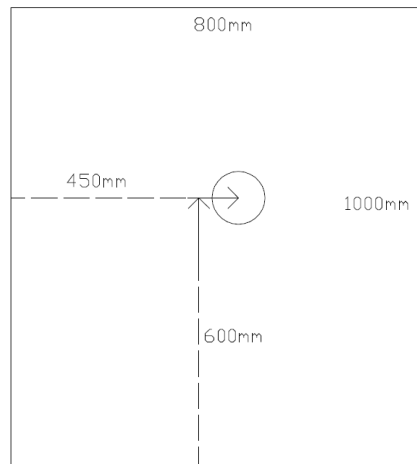

Test Baffle (speaker mounted in circle)

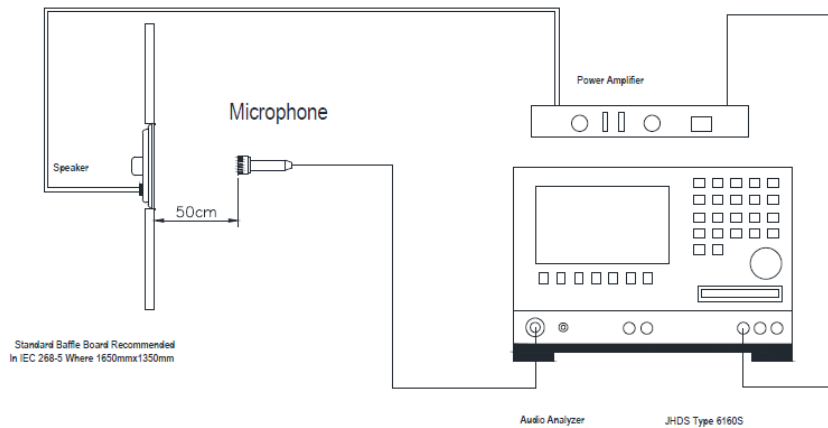

Frequency Response (measured at 50cm with 1W input power)

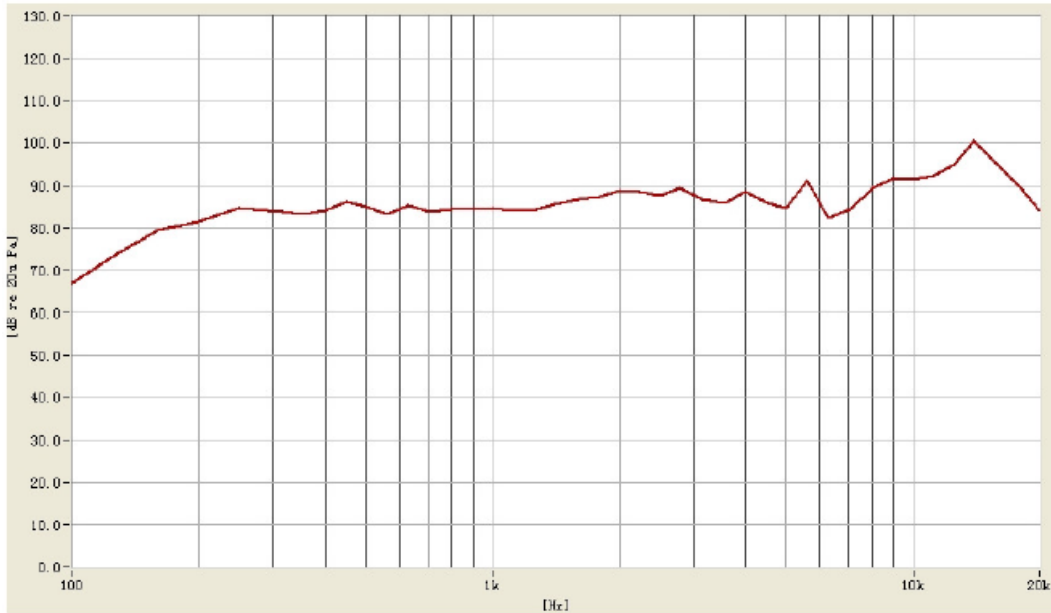

Reliability Testing

Type of Test	Test Specifications
High Temperature Test	96 hours at +85°C ± 3°C followed by six hours in normal room temperature
Low Temperature Test	96 hours at -40°C ± 3°C followed by six hours in normal room temperature
Humidity Test	96 hours at +30°C ± 3°C with relative humidity at 92% to 95% followed by 3 hours in normal room temperature
Temperature Cycle Testing	<p>The part shall be subjected to 5 cycles using the following procedure:</p>
Vibration Test	10 to 55 to 10 Hz cycles, 15 minutes per cycle. 2 hours in each axis X, Y, and Z.
Drop Test	Drop the speakers onto a 40mm thick board 10 times from a height of 75cm.
Load Test	Pink noise is applied at the speakers rated power for 96 hours at room temperature

After each test, the speaker's SPL shall be ±3 dB of the original SPL

Dimensions

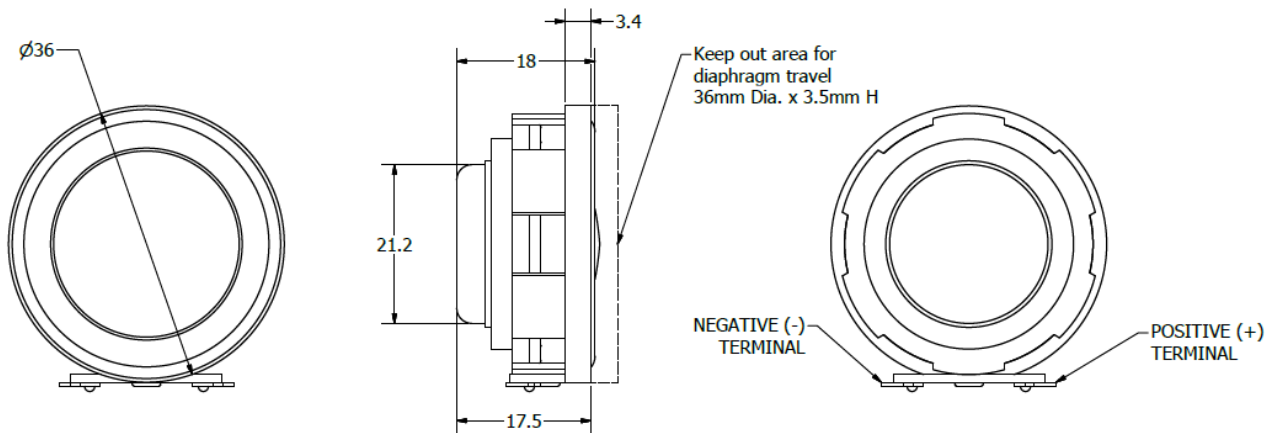

Packaging

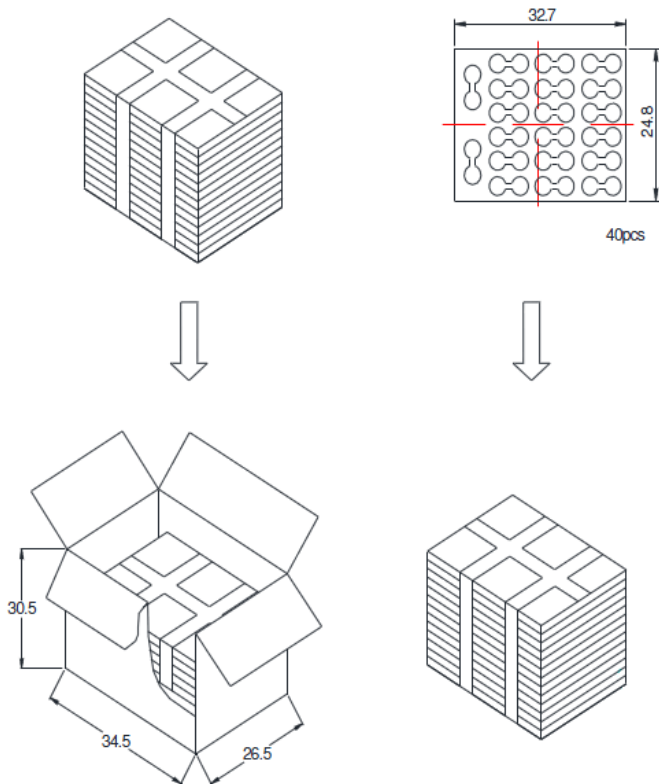

40 pcs per tray
240 trays for unit, 2 units per carton
Total:480pcs per box
Size:34.5*26.5*30.5cm

Specifications Revisions

Revision	Description	Date
	Released from Engineering	5/11/2017
A	Updated Weight and added Packaging Specifications	7/13/2017

Note:

1. Unless otherwise specified:
 - A. All dimensions are in millimeters.
 - B. Default tolerances are $\pm 0.5\text{mm}$ and angles are $\pm 3^\circ$.
2. Specifications subject to change or withdrawal without notice.
3. This part is RoHS 2011/65/EU Compliant.