



VISHAY INTERTECHNOLOGY, INC.

INTERACTIVE

data book

SMD MAGNETICS, INDUCTORS AND FERRITE BEADS

VISHAY DALE

VSE-DB0059-1201e

Notes:

1. To navigate:
 - a) Click on the Vishay logo on any datasheet to go to the Contents page for that section. Click on the Vishay logo on any Contents page to go to the main Table of Contents page.
 - b) Click on the products within the Table of Contents to go directly to the datasheet.
 - c) Use the scroll or page up/page down functions.
 - d) Use the Adobe® Acrobat® page function in the browser bar.

2. To search the text of the catalog use the Adobe® Acrobat® search function.



One of the World's Largest Manufacturers of
Discrete Semiconductors and Passive Components



VISHAY INTERTECHNOLOGY, INC.



SMD MAGNETICS, INDUCTORS AND FERRITE BEADS

VISHAY DALE

High Current Inductors

RF Inductors

Multilayer Inductors

Multilayer Ferrite Beads

Transformers

SEMICONDUCTORS

RECTIFIERS

- Schottky (single, dual)
- Standard, Fast and Ultra-Fast Recovery (single, dual)
- Bridge
- Superrectifier®
- Sinterglass Avalanche Diodes

HIGH-POWER DIODES AND THYRISTORS

- High-Power Fast-Recovery Diodes
- Phase-Control Thyristors
- Fast Thyristors

SMALL-SIGNAL DIODES

- Schottky and Switching (single, dual)
- Tuner/Capacitance (single, dual)
- Bandswitching
- PIN

ZENER AND SUPPRESSOR DIODES

- Zener (single, dual)
- TVS (TRANZORB®, Automotive, ESD, Arrays)

FETs

- Low-Voltage TrenchFET® Power MOSFETs
- High-Voltage TrenchFET® Power MOSFETs
- High-Voltage Planar MOSFETs
- JFETs

OPTOELECTRONICS

- IR Emitters and Detectors, and IR Receiver Modules
- Optocouplers and Solid-State Relays
- Optical Sensors
- LEDs and 7-Segment Displays
- Infrared Data Transceiver Modules
- Custom Products

ICs

- Power ICs
- Analog Switches

MODULES

- Power Modules (contain power diodes, thyristors, MOSFETs, IGBTs)

PASSIVE COMPONENTS

RESISTIVE PRODUCTS

- Film Resistors
 - Metal Film Resistors
 - Thin Film Resistors
 - Thick Film Resistors
 - Metal Oxide Film Resistors
 - Carbon Film Resistors
- Wirewound Resistors
- Power Metal Strip® Resistors
- Chip Fuses
- Variable Resistors
 - Cermet Variable Resistors
 - Wirewound Variable Resistors
 - Conductive Plastic Variable Resistors
- Networks/Arrays
- Non-Linear Resistors
 - NTC Thermistors
 - PTC Thermistors
 - Varistors

MAGNETICS

- Inductors
- Transformers

CAPACITORS

- Tantalum Capacitors
 - Molded Chip Tantalum Capacitors
 - Coated Chip Tantalum Capacitors
 - Solid Through-Hole Tantalum Capacitors
 - Wet Tantalum Capacitors
- Ceramic Capacitors
 - Multilayer Chip Capacitors
 - Disc Capacitors
- Film Capacitors
- Power Capacitors
- Heavy-Current Capacitors
- Aluminum Capacitors

Vishay Dale

SMD Magnetics, Inductors and Ferrite Beads

Vishay Dale
1505 E. Highway 50
P.O. Box 180
Yankton, SD 57078-0180, USA
Phone: +1 605 665 9301
Fax: +1 605 665 1627
www.vishay.com

DISCLAIMER

All product specifications and data are subject to change without notice.

Vishay Intertechnology, Inc., its affiliates, agents, and employees, and all persons acting on its or their behalf (collectively, "Vishay"), disclaim any and all liability for any errors, inaccuracies or incompleteness contained herein or in any other disclosure relating to any product.

Vishay disclaims any and all liability arising out of the use or application of any product described herein or of any information provided herein to the maximum extent permitted by law. The product specifications do not expand or otherwise modify Vishay's terms and conditions of purchase, including but not limited to the warranty expressed therein, which apply to these products.

No license, express or implied, by estoppel or otherwise, to any intellectual property rights is granted by this document or by any conduct of Vishay.

The products shown herein are not designed for use in medical, life-saving, or life-sustaining applications unless otherwise expressly indicated. Customers using or selling Vishay products not expressly indicated for use in such applications do so entirely at their own risk and agree to fully indemnify Vishay for any damages arising or resulting from such use or sale. Please contact authorized Vishay personnel to obtain written terms and conditions regarding products designed for such applications.

Product names and markings noted herein may be trademarks of their respective owners.



SMD Magnetics, Inductors, and Ferrite Beads

Alphabetical Index 3
POWER INDUCTORS
IHLP-1212AB-11 6
IHLP-1212AE-11 8
IHLP-1212BZ-11 10
IHLP-1616AB-01 14
IHLP-1616AB-11 17
IHLP-1616BZ-01 20
IHLP-1616BZ-11 23
IHLP-2020BZ-01 25
IHLP-2020BZ-11 30
IHLP-2020CZ-01 35
IHLP-2020CZ-11 38
IHLP-2525AH-01 43
IHLP-2525BD-01 46
IHLP-2525CZ-01 49
IHLP-2525CZ-11 52
IHLP-2525CZ-06 54
IHLP-2525CZ-07 57
IHLP-2525EZ-01 60
IHLP-3232CZ-01 63
IHLP-3232CZ-11 68
IHLP-3232DZ-01 73
IHLP-3232DZ-11 78
IHLP-4040DZ-01 83
IHLP-4040DZ-11 86
IHLP-5050CE-01 90
IHLP-5050CE-06 94
IHLP-5050CE-07 97
IHLP-5050EZ-01 100
IHLP-5050FD-01 104
IHLP-6767DZ-01 108
IHLP-6767DZ-11 111
IHLP-6767GZ-01 116
IHLP-6767GZ-11 120
IHLP-6767GZ-51 124
IHLW-4040CF-11 127
IHLW-5050CE-01 130
IHLM-2525CZ-01 134
IHLM-2525CZ-06 137
IHLM-2525CZ-07 140
IFLP-4040DZ-01 143
IFSC-0806AZ-01 145
IFSC-1008AB-01 146
IFSC-1111AZ-01 147
IFSC-1111AB-01 148
IFSC-1515AH-01 149
IHSM-3825 150
IHSM-4825 151
IHSM-5832 152
IHSM-7832 153
IDC-2512 154
IDC-5020 155
IDC-7328 156
IDCS-2512 157
IDCS-5020 158
IDCS-7328 159
IDCP-1813 160
IDCP-2218 161
IDCP-3020 162
IDCP-3114 163
IDCP-3722 164
IDCP-3916 165



HIGH FREQUENCY INDUCTORS

IFCB-0402.....	167
IFCB-0603.....	168
ILC-0402.....	169
ILC-0603.....	170
ILC-0805.....	171
IMC-0402.....	172
IMC-0603.....	173

WIREWOUND INDUCTORS

IMC-0402-01.....	175
IMC-0603-01.....	177
IMC-0805.....	179
IMC-0805-01.....	180
IMC-1008.....	182
ISC-1008.....	184
IMC-1210.....	186
IMC-1210-100.....	187
ISC-1210.....	188
IMC-1812.....	189
ISC-1812.....	191
IMCH-1812.....	193
IMC-2220.....	194

COMMON MODE CHOKES

ICM-0805.....	196
ICM-1206.....	197
ICM-2824, ICM-3528, ICM-4743.....	198

MULTILAYER FERRITE INDUCTORS AND BEADS

ILSB-0603.....	200
ILSB-0805.....	202
ILSB-1206.....	204
ILBB-0402.....	206
ILBB-0603.....	209
ILBB-0805.....	212
ILB-1206.....	217
ILBB-1210, ILBB-1806, ILBB-1812.....	221
ILHB.....	223
ILAS-1206.....	227

TRANSFORMERS/INDUCTORS

LPE-3325-CST.....	230
LPE-3325.....	231
LPE-4841.....	233
LPE-5047.....	235
LPE-6562.....	237
LPE-6855.....	239
LPT-3535.....	241
LPT-4545.....	243

REFERENCE INFORMATION

Custom Products.....	246
Definitions.....	254
Engineering Note ILB, ILBB, IMC, ISC, IFC.....	261
Engineering Note ILB, ILBB Ferrite Beads.....	268
Engineering Note.....	274
Packaging Methods.....	276
Conversion Tables.....	278
Linear Tech Cross Reference.....	279



SMD Magnetics, Inductors, and Ferrite Beads

Conversion Tables 278
Custom Products 246
Definitions 254
Engineering Note 274
Engineering Note ILB, ILBB, IMC, ISC, IFC 261
Engineering Note ILB, ILBB Ferrite Beads 268
ICM-0805 196
ICM-1206 197
ICM-2824, ICM-3528, ICM-4743 198
IDC-2512 154
IDC-5020 155
IDC-7328 156
IDCP-1813 160
IDCP-2218 161
IDCP-3020 162
IDCP-3114 163
IDCP-3722 164
IDCP-3916 165
IDCS-2512 157
IDCS-5020 158
IDCS-7328 159
IFCB-0402 167
IFCB-0603 168
IFLP-4040DZ-01 143
IFSC-0806AZ-01 145
IFSC-1008AB-01 146
IFSC-1111AB-01 148
IFSC-1111AZ-01 147
IFSC-1515AH-01 149
IHLM-2525CZ-01 134
IHLM-2525CZ-06 137
IHLM-2525CZ-07 140
IHLP-1212AB-11 6
IHLP-1212AE-11 8
IHLP-1212BZ-11 10
IHLP-1616AB-01 14
IHLP-1616AB-11 17
IHLP-1616BZ-01 20
IHLP-1616BZ-11 23
IHLP-2020BZ-01 25
IHLP-2020BZ-11 30
IHLP-2020CZ-01 35
IHLP-2020CZ-11 38
IHLP-2525AH-01 43
IHLP-2525BD-01 46
IHLP-2525CZ-01 49
IHLP-2525CZ-11 52
IHLP-2525CZ-06 54
IHLP-2525CZ-07 57
IHLP-2525EZ-01 60
IHLP-3232CZ-01 63
IHLP-3232CZ-11 68
IHLP-3232DZ-01 73
IHLP-3232DZ-11 78
IHLP-4040DZ-01 83
IHLP-4040DZ-11 86



IHLP-5050CE-01	90
IHLP-5050CE-06	94
IHLP-5050CE-07	97
IHLP-5050EZ-01	100
IHLP-5050FD-01	104
IHLP-6767DZ-01	108
IHLP-6767DZ-11	111
IHLP-6767GZ-01	116
IHLP-6767GZ-11	120
IHLP-6767GZ-51	124
IHLW-4040CF-11	127
IHLW-5050CE-01	130
IHSM-3825	150
IHSM-4825	151
IHSM-5832	152
IHSM-7832	153
ILAS-1206	227
ILB-1206	217
ILBB-0402	206
ILBB-0603	209
ILBB-0805	212
ILBB-1210, ILBB-1806, ILBB-1812	221
ILC-0402	169
ILC-0603	170
ILC-0805	171
ILHB	223
ILSB-0603	200
ILSB-0805	202
ILSB-1206	204
IMC-0402	172
IMC-0603	173
IMC-0402-01	175
IMC-0603-01	177
IMC-0805	179
IMC-0805-01	180
IMC-1008	182
IMC-1210	186
IMC-1210-100	187
IMC-1812	189
IMC-2220	194
IMCH-1812	193
ISC-1008	184
ISC-1210	188
ISC-1812	191
Linear Tech Cross Reference	279
LPE-3325	231
LPE-3325-CST	230
LPE-4841	233
LPE-5047	235
LPE-6562	237
LPE-6855	239
LPT-3535	241
LPT-4545	243
Packaging Methods	276



Power Inductors

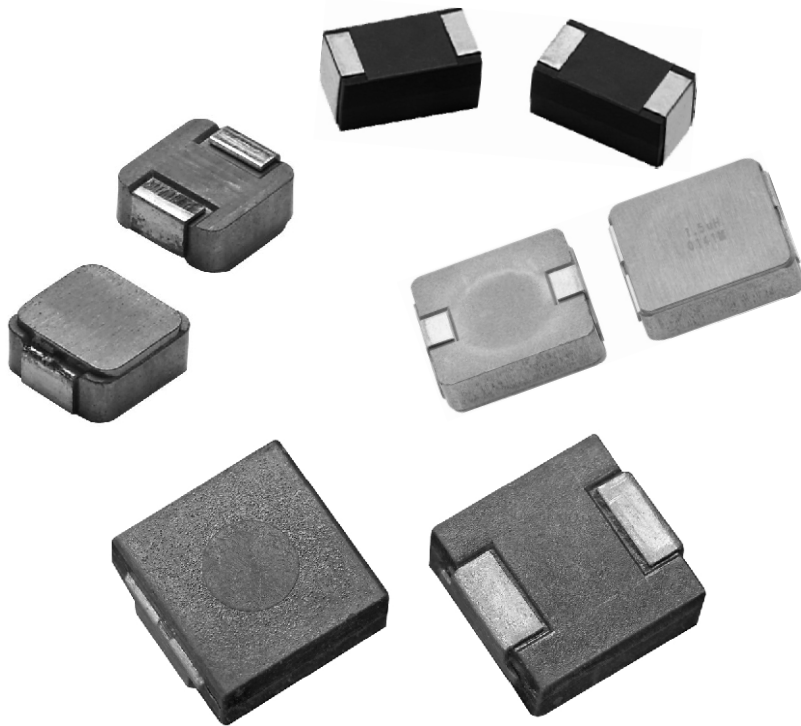

Contents

IHLP-1212AB-11	6
IHLP-1212AE-11	8
IHLP-1212BZ-11	10
IHLP-1616AB-01	14
IHLP-1616AB-11	17
IHLP-1616BZ-01	20
IHLP-1616BZ-11	23
IHLP-2020BZ-01	25
IHLP-2020BZ-11	30
IHLP-2020CZ-01	35
IHLP-2020CZ-11	38
IHLP-2525AH-01	43
IHLP-2525BD-01	46
IHLP-2525CZ-01	49
IHLP-2525CZ-11	52
IHLP-2525CZ-06	54
IHLP-2525CZ-07	57
IHLP-2525EZ-01	60
IHLP-3232CZ-01	63
IHLP-3232CZ-11	68
IHLP-3232DZ-01	73
IHLP-3232DZ-11	78
IHLP-4040DZ-01	83
IHLP-4040DZ-11	86
IHLP-5050CE-01	90
IHLP-5050CE-06	94
IHLP-5050CE-07	97
IHLP-5050EZ-01	100
IHLP-5050FD-01	104
IHLP-6767DZ-01	108
IHLP-6767DZ-11	111
IHLP-6767GZ-01	116
IHLP-6767GZ-11	120
IHLP-6767GZ-51	124
IHLW-4040CF-11	127
IHLW-5050CE-01	130
IHLM-2525CZ-01	134
IHLM-2525CZ-06	137
IHLM-2525CZ-07	140
IFLP-4040DZ-01	143
IFSC-0806AZ-01	145
IFSC-1008AB-01	146
IFSC-1111AZ-01	147
IFSC-1111AB-01	148
IFSC-1515AH-01	149
IHSM-3825	150
IHSM-4825	151
IHSM-5832	152
IHSM-7832	153
IDC-2512	154
IDC-5020	155
IDC-7328	156
IDCS-2512	157
IDCS-5020	158
IDCS-7328	159
IDCP-1813	160
IDCP-2218	161
IDCP-3020	162
IDCP-3114	163
IDCP-3722	164
IDCP-3916	165

Low Profile, High Current IHLP® Inductors

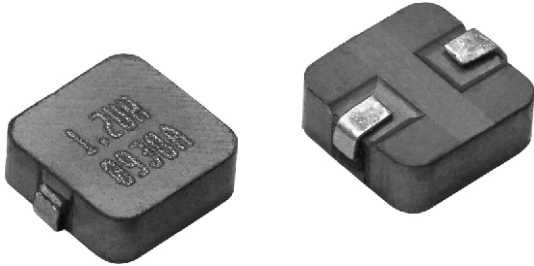

Manufactured under one or more of the following:
US Patents; 6,198,375/6,204,744/6,449,829/6,460,244.
 Several foreign patents, and other patents pending.

STANDARD ELECTRICAL SPECIFICATIONS				
L ₀ INDUCTANCE ± 20 % AT 100 kHz, 0.25 V, 0 A (μH)	DCR TYP. 25 °C (mΩ)	DCR MAX. 25 °C (mΩ)	HEAT RATING CURRENT DC TYP. (A) ⁽³⁾	SATURATION CURRENT DC TYP. (A) ⁽⁴⁾
0.22	9.5	11.4	9.3	9.3
0.33	12.0	14.3	7.2	8.7
0.47	16.3	19.5	6.4	7.0
0.56	18.7	22.0	5.1	6.7
0.68	22.5	25.0	4.0	5.5
1.0	33.0	38.0	3.0	4.5

Notes

- (1) All test data is referenced to 25 °C ambient
- (2) Operating temperature range - 55 °C to + 125 °C
- (3) DC current (A) that will cause an approximate ΔT of 40 °C
- (4) DC current (A) that will cause L₀ to drop approximately 20 %
- (5) The part temperature (ambient + temp. rise) should not exceed 125 °C under worst case operating conditions. Circuit design, component placement, PWB trace size and thickness, airflow and other cooling provisions all affect the part temperature. Part temperature should be verified in the end application.

FEATURES

- Shielded construction
- Frequency range up to 1.0 MHz
- Lowest DCR/μH, in this package size
- Handles high transient current spikes without saturation
- Ultra low buzz noise, due to composite construction
- Compliant to RoHS Directive 2002/95/EC
- Halogen-free according to IEC 61249-2-21 definition



RoHS
 COMPLIANT
 HALOGEN
FREE

APPLICATIONS

- PDA/notebook/desktop/server applications
- High current POL converters
- Low profile, high current power supplies
- Battery powered devices
- DC/DC converters in distributed power systems
- DC/DC converter for Field Programmable Gate Array (FPGA)

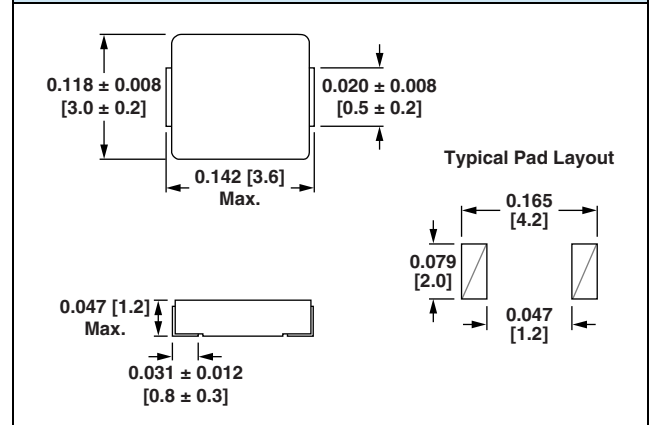
DIMENSIONS in inches [millimeters]

DESCRIPTION

IHLP-1212AB-11	0.22 μH	± 20 %	ER	e3
MODEL	INDUCTANCE VALUE	INDUCTANCE TOLERANCE	PACKAGE CODE	JEDEC LEAD (Pb)-FREE STANDARD

GLOBAL PART NUMBER

I	H	L	P	1	2	1	2	A	B	E	R	R	2	2	M	1	1
PRODUCT FAMILY				SIZE					PACKAGE CODE		INDUCTANCE VALUE			TOL.	SERIES		

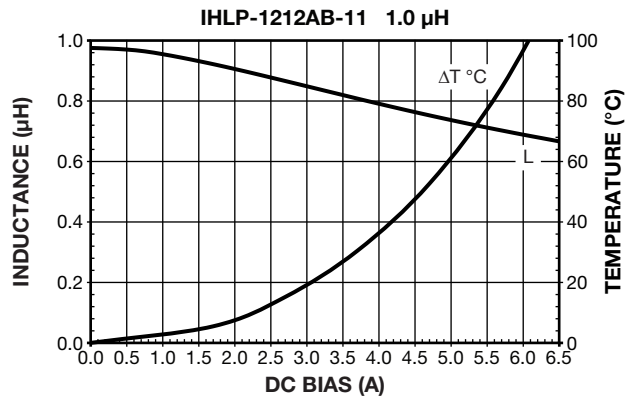
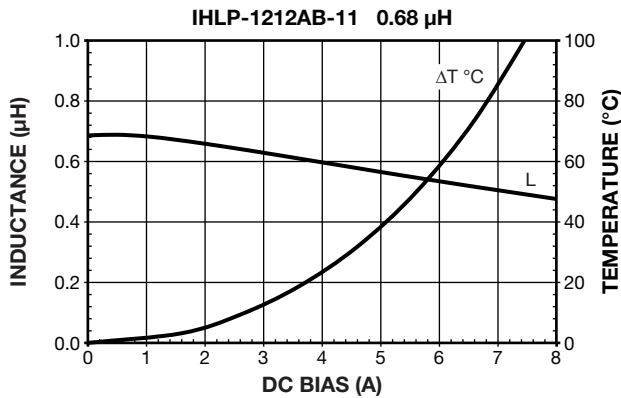
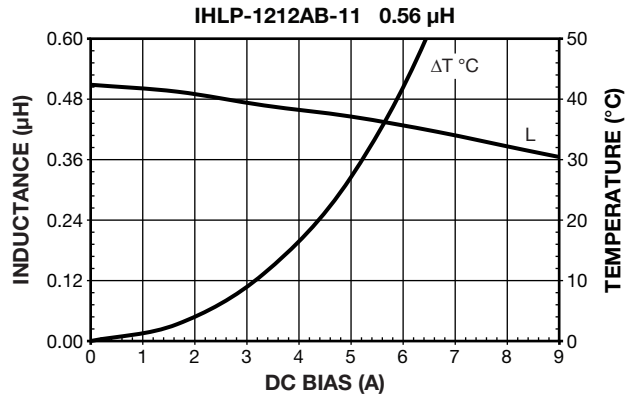
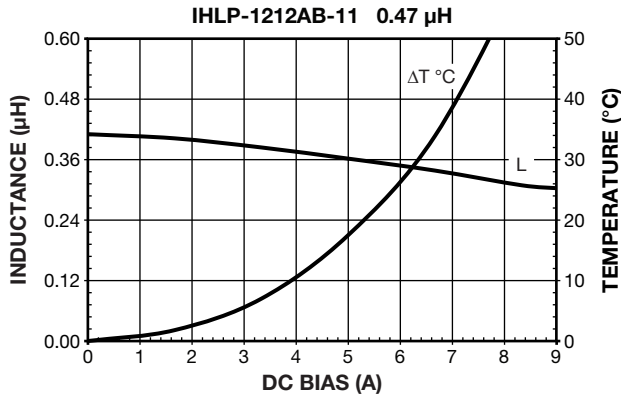
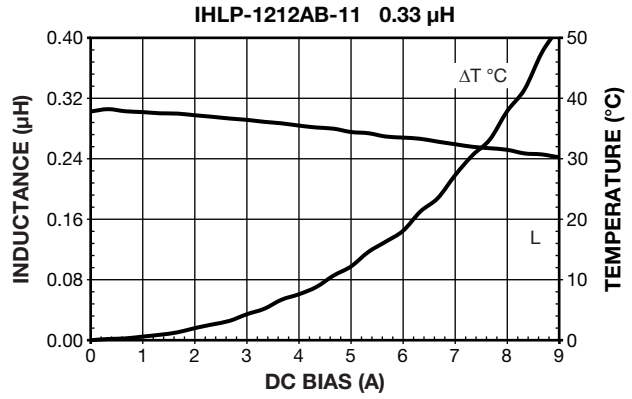
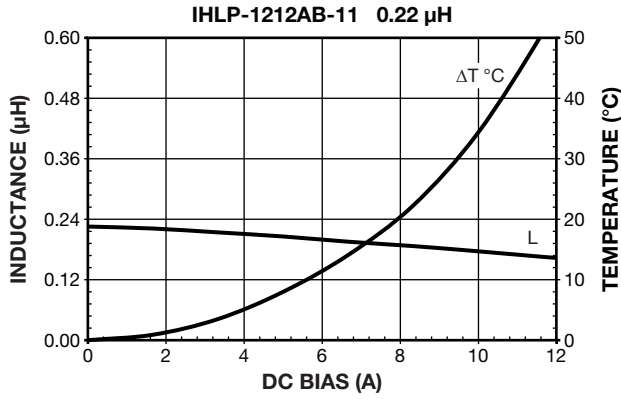
PERFORMANCE GRAPHS



Low Profile, High Current IHLP® Inductors

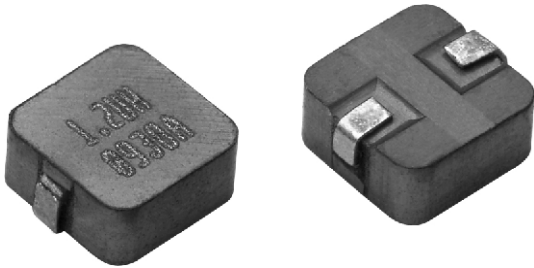

Manufactured under one or more of the following:
US Patents; 6,198,375/6,204,744/6,449,829/6,460,244.
 Several foreign patents, and other patents pending.

STANDARD ELECTRICAL SPECIFICATIONS				
L ₀ INDUCTANCE ± 20 % AT 100 kHz, 0.25 V, 0 A (μH)	DCR TYP. 25 °C (mΩ)	DCR MAX. 25 °C (mΩ)	HEAT RATING CURRENT DC TYP. (A) ⁽³⁾	SATURATION CURRENT DC TYP. (A) ⁽⁴⁾
0.22	9.5	11.4	8.5	9.0
0.33	11.5	13.8	7.8	7.0
0.47	12.7	15.0	6.7	6.7
0.56	17.0	20.4	6.0	5.5
0.68	18.4	22.0	5.4	5.5
0.82	22.5	26.0	4.9	5.5
1.0	29.5	33.0	3.9	5.3
1.5	41.0	46.0	2.7	4.5

Notes

- (1) All test data is referenced to 25 °C ambient
- (2) Operating temperature range - 55 °C to + 125 °C
- (3) DC current (A) that will cause an approximate ΔT of 40 °C
- (4) DC current (A) that will cause L₀ to drop approximately 20 %
- (5) The part temperature (ambient + temp. rise) should not exceed 125 °C under worst case operating conditions. Circuit design, component placement, PWB trace size and thickness, airflow and other cooling provisions all affect the part temperature. Part temperature should be verified in the end application.

FEATURES

- Shielded construction
- Frequency range up to 1.0 MHz
- Lowest DCR/μH, in this package size
- Handles high transient current spikes without saturation
- Ultra low buzz noise, due to composite construction
- Compliant to RoHS Directive 2002/95/EC
- Halogen-free according to IEC 61249-2-21 definition



RoHS
COMPLIANT
HALOGEN
FREE

APPLICATIONS

- PDA/notebook/desktop/server applications
- High current POL converters
- Low profile, high current power supplies
- Battery powered devices
- DC/DC converters in distributed power systems
- DC/DC converter for Field Programmable Gate Array (FPGA)

DIMENSIONS in inches [millimeters]

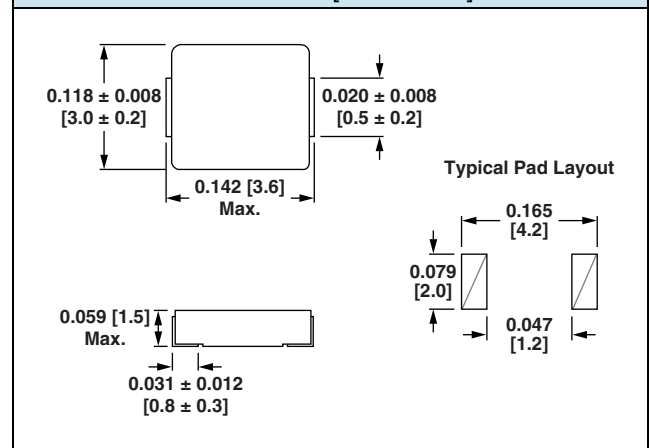

DESCRIPTION				
IHLP-1212AE-11	0.22 μH	± 20 %	ER	e3
MODEL	INDUCTANCE VALUE	INDUCTANCE TOLERANCE	PACKAGE CODE	JEDEC LEAD (Pb)-FREE STANDARD

GLOBAL PART NUMBER																	
I	H	L	P	1	2	1	2	A	E	E	R	R	2	2	M	1	1
PRODUCT FAMILY				SIZE				PACKAGE CODE		INDUCTANCE VALUE		TOL.	SERIES				

PERFORMANCE GRAPHS

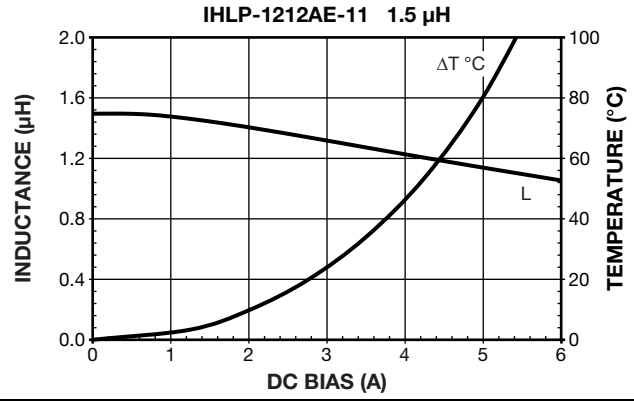
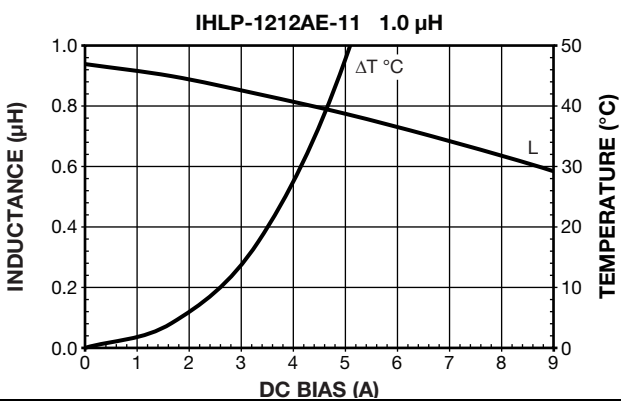
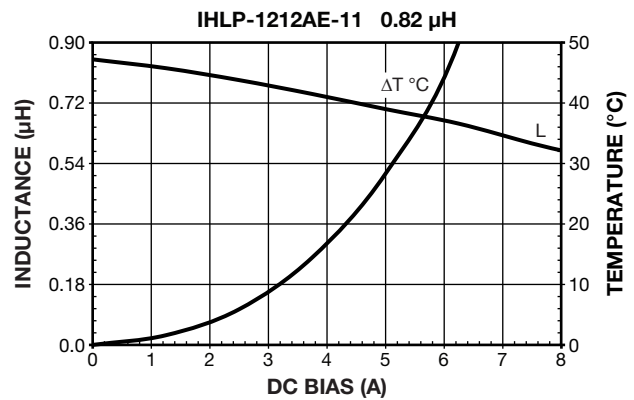
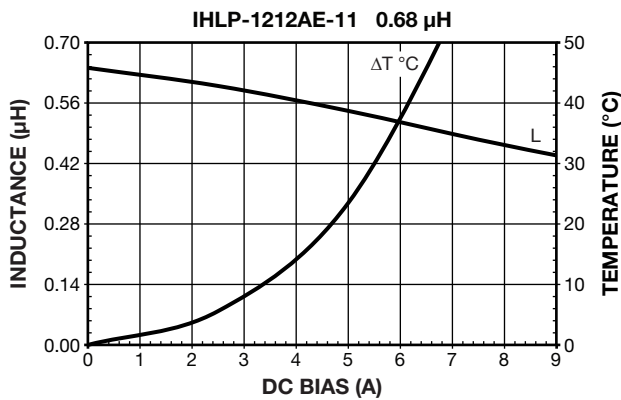
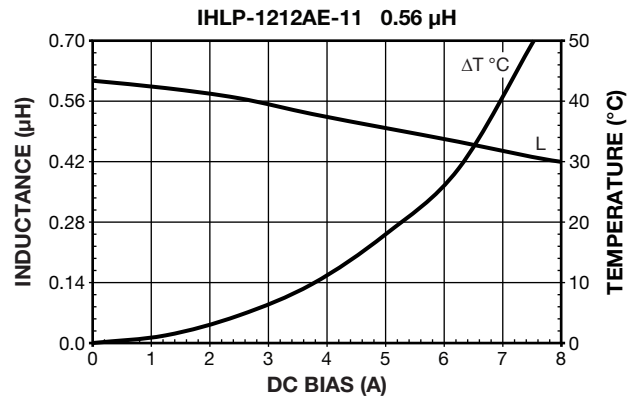
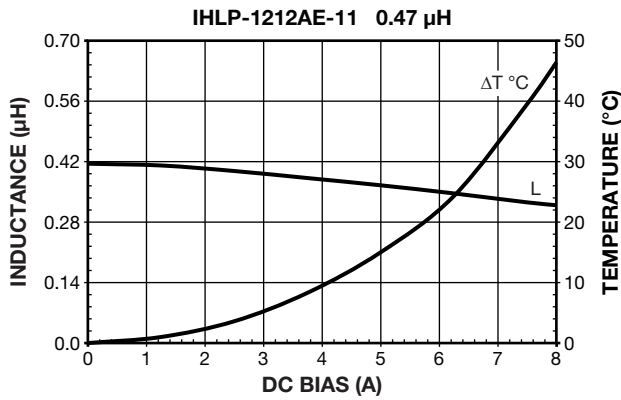
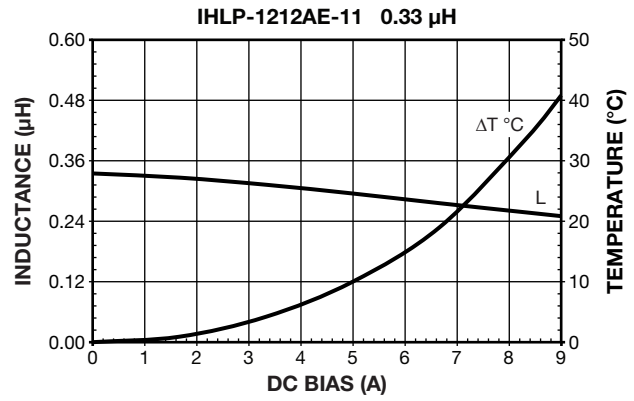
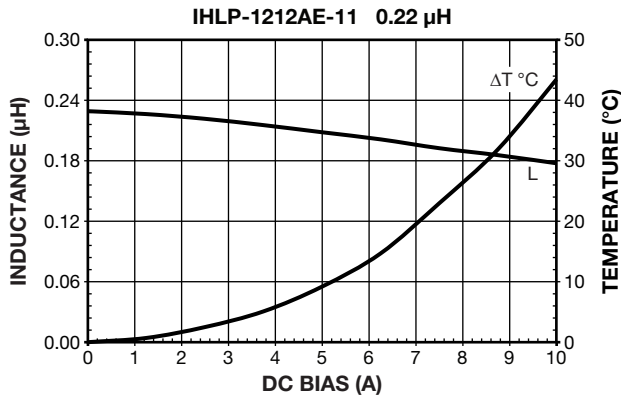

Low Profile, High Current IHLP® Inductors

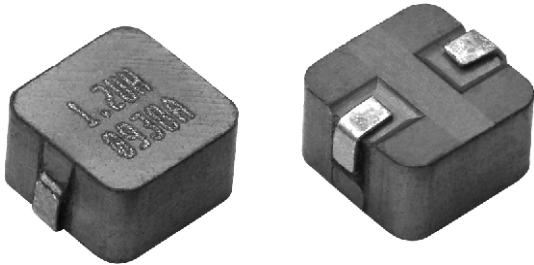

Manufactured under one or more of the following:
US Patents; 6,198,375/6,204,744/6,449,829/6,460,244.
 Several foreign patents, and other patents pending.

STANDARD ELECTRICAL SPECIFICATIONS				
L ₀ INDUCTANCE ± 20 % AT 100 kHz, 0.25 V, 0 A (μH)	DCR TYP. 25 °C (mΩ)	DCR MAX. 25 °C (mΩ)	HEAT RATING CURRENT DC TYP. (A) ⁽³⁾	SATURATION CURRENT DC TYP. (A) ⁽⁴⁾
0.22	9.5	11.4	6.5	7.5
0.36	11.5	13.8	6.3	6.5
0.56	16.2	19.4	5.5	5.5
0.68	17.0	20.4	5.5	5.0
0.88	18.5	22.0	5.5	4.5
1.0	20.0	24.0	5.0	4.5
1.2	23.0	27.0	5.0	4.0
1.5	28.5	32.0	3.8	4.0
2.2	42.9	46.0	3.0	3.3
3.3	56.0	61.0	2.7	3.3

Notes

- (1) All test data is referenced to 25 °C ambient
- (2) Operating temperature range - 55 °C to + 125 °C
- (3) DC current (A) that will cause an approximate ΔT of 40 °C
- (4) DC current (A) that will cause L₀ to drop approximately 20 %
- (5) The part temperature (ambient + temp. rise) should not exceed 125 °C under worst case operating conditions. Circuit design, component placement, PWB trace size and thickness, airflow and other cooling provisions all affect the part temperature. Part temperature should be verified in the end application.

FEATURES

- Shielded construction
- Frequency range up to 1.0 MHz
- Lowest DCR/μH, in this package size
- Handles high transient current spikes without saturation
- Ultra low buzz noise, due to composite construction
- Compliant to RoHS Directive 2002/95/EC
- Halogen-free according to IEC 61249-2-21 definition



RoHS
 COMPLIANT
 HALOGEN
FREE

APPLICATIONS

- PDA/notebook/desktop/server applications
- High current POL converters
- Low profile, high current power supplies
- Battery powered devices
- DC/DC converters in distributed power systems
- DC/DC converter for Field Programmable Gate Array (FPGA)
- Currently not recommended for automotive applications

DIMENSIONS in inches [millimeters]

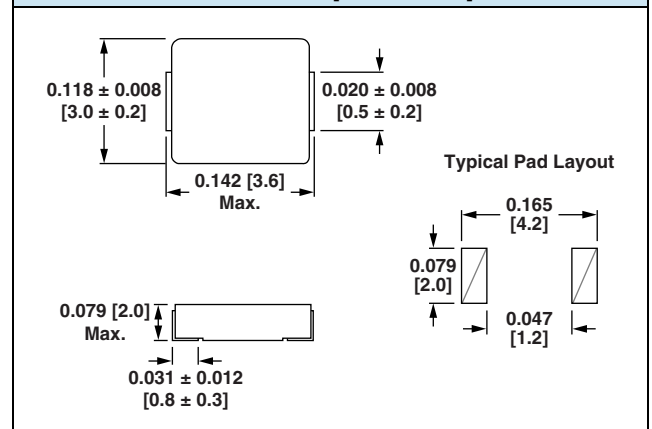

DESCRIPTION

IHLP-1212BZ-11	0.22 μH	± 20 %	ER	e3
MODEL	INDUCTANCE VALUE	INDUCTANCE TOLERANCE	PACKAGE CODE	JEDEC LEAD (Pb)-FREE STANDARD

GLOBAL PART NUMBER

I	H	L	P	1	2	1	2	B	Z	E	R	R	2	2	M	1	1
PRODUCT FAMILY				SIZE				PACKAGE CODE		INDUCTANCE VALUE		TOL.	SERIES				

PERFORMANCE GRAPHS

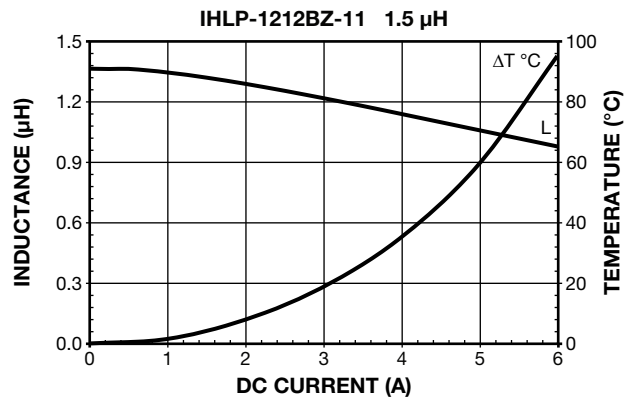
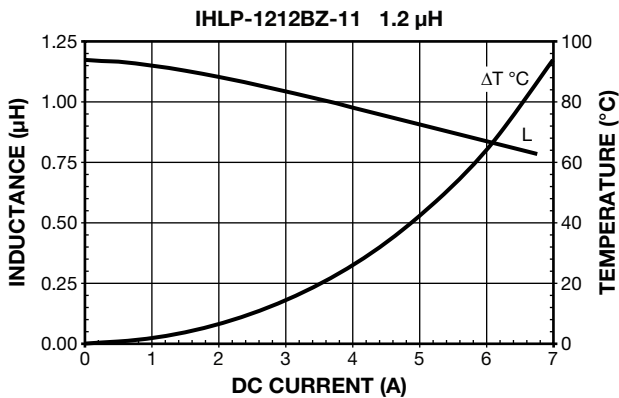
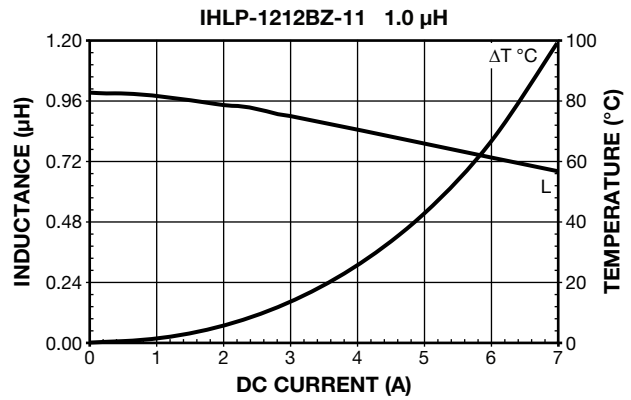
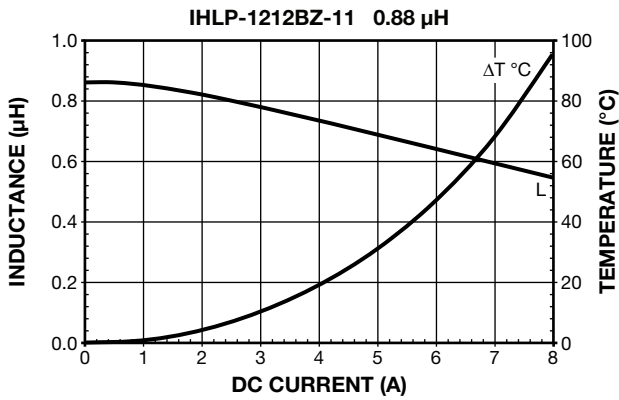
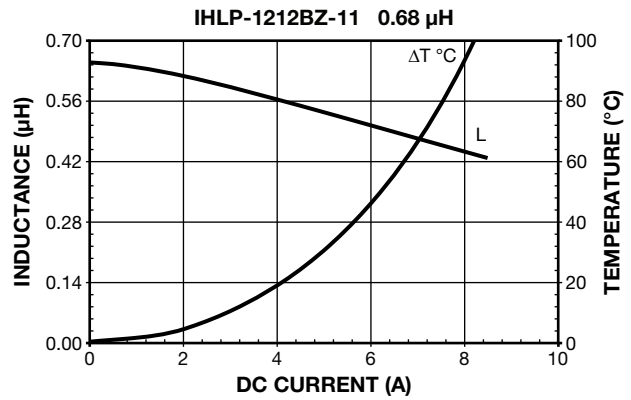
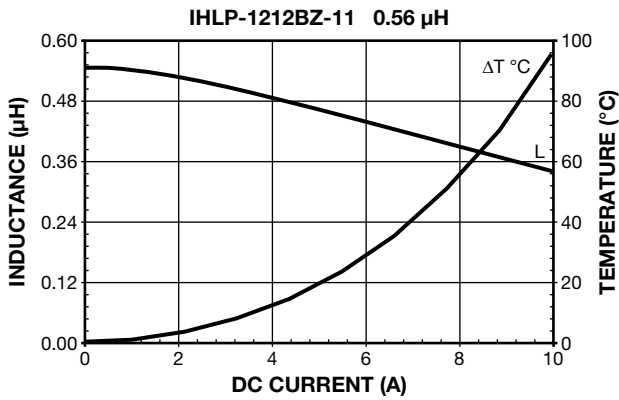
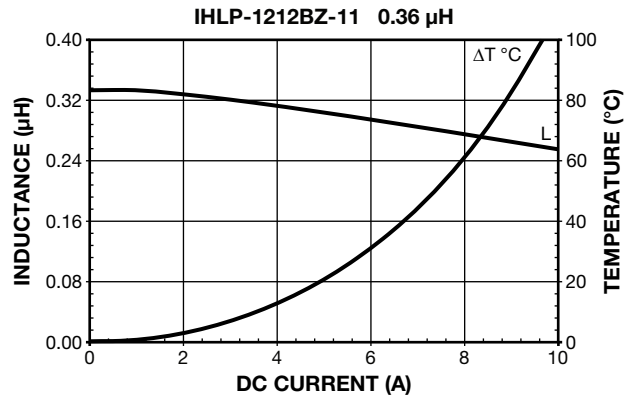
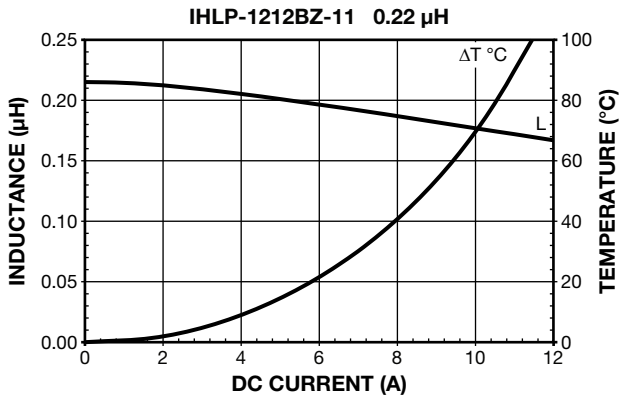



PERFORMANCE GRAPHS

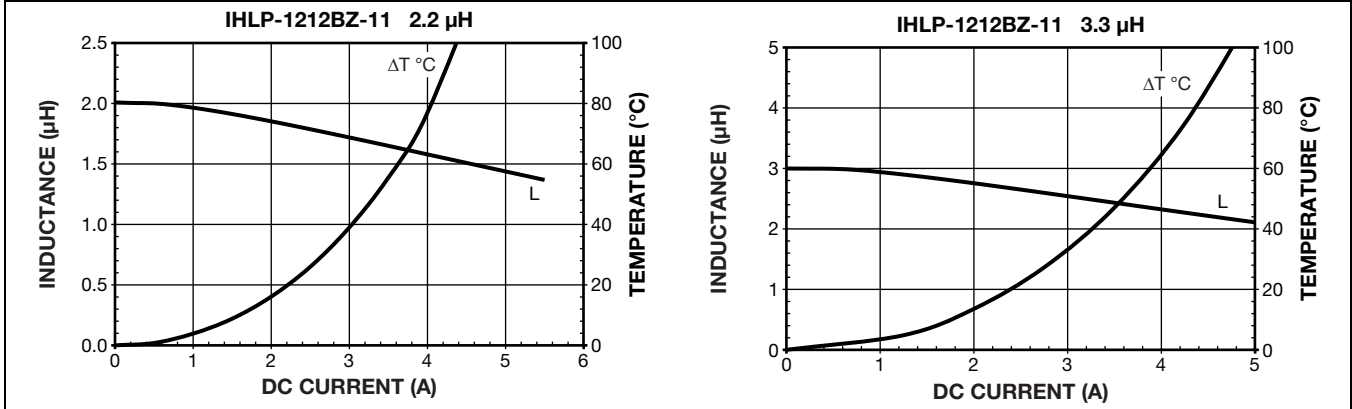

PERFORMANCE GRAPHS: INDUCTANCE AND Q VS. FREQUENCY

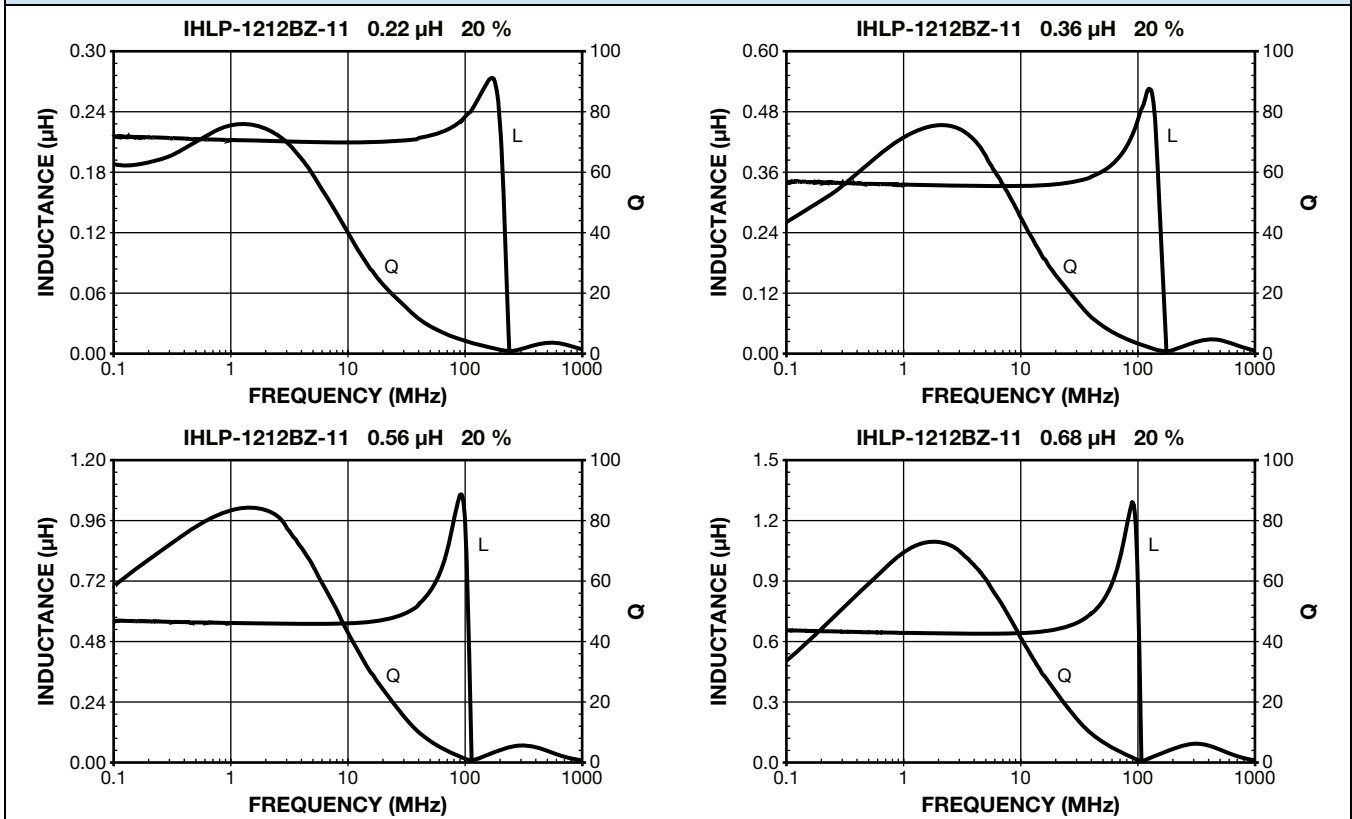

PERFORMANCE GRAPHS: INDUCTANCE AND Q VS. FREQUENCY

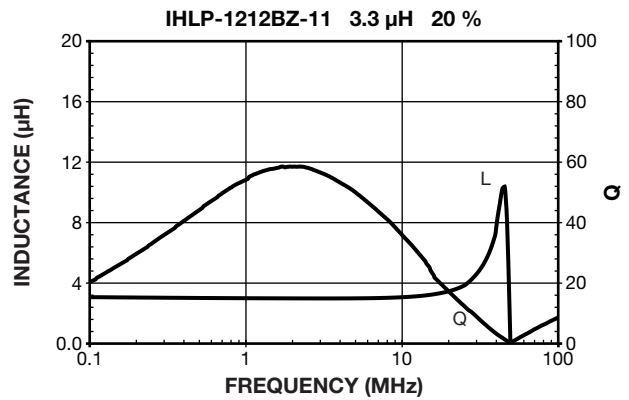
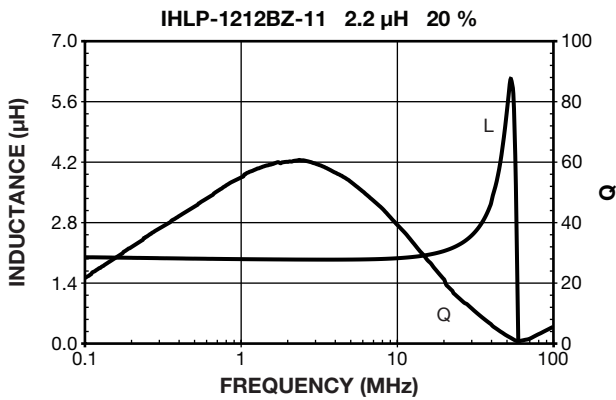
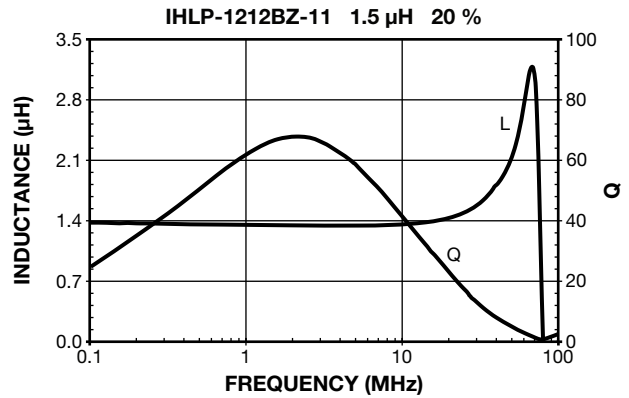
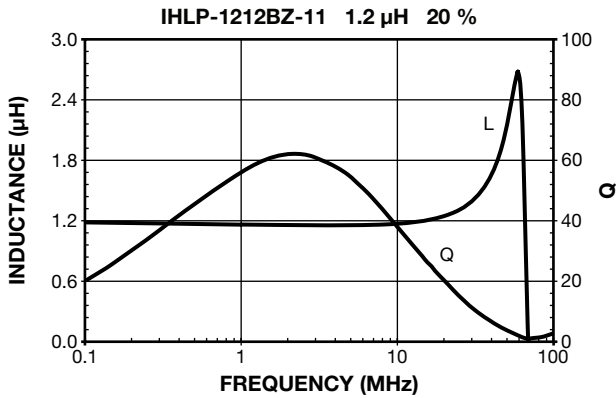
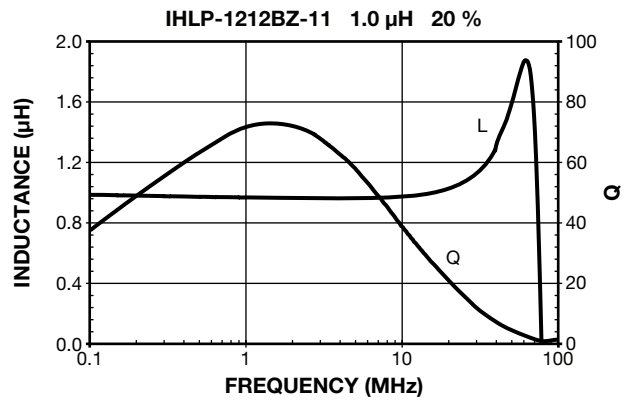
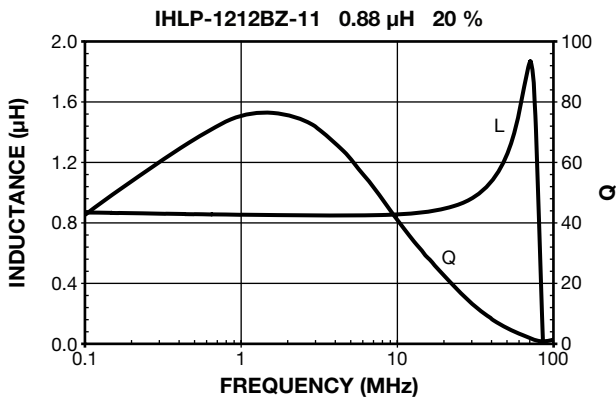

Low Profile, High Current IHLP® Inductors



Manufactured under one or more of the following:
US Patents; 6,198,375/6,204,744/6,449,829/6,460,244.
 Several foreign patents, and other patents pending.

STANDARD ELECTRICAL SPECIFICATIONS				
L_0 INDUCTANCE $\pm 20\%$ AT 100 kHz, 0.25 V, 0 A (μH)	DCR TYP. 25 °C (m Ω)	DCR MAX. 25 °C (m Ω)	HEAT RATING CURRENT DC TYP. (A) ⁽³⁾	SATURATION CURRENT DC TYP. (A) ⁽⁴⁾
0.047	3.25	3.75	13.0	32.0
0.10	5.50	6.00	11.5	25.0
0.22	11.0	12.0	8.5	20.0
0.47	20.0	22.0	5.0	13.0
1.00	50.0	52.5	4.0	8.5

Notes

- (1) All test data is referenced to 25 °C ambient
- (2) Operating temperature range - 55 °C to + 125 °C
- (3) DC current (A) that will cause an approximate ΔT of 40 °C
- (4) DC current (A) that will cause L_0 to drop approximately 20 %
- (5) The part temperature (ambient + temp. rise) should not exceed 125 °C under worst case operating conditions. Circuit design, component placement, PWB trace size and thickness, airflow and other cooling provisions all affect the part temperature. Part temperature should be verified in the end application.

FEATURES

- Shielded construction
- Frequency range up to 5.0 MHz
- Lowest DCR/ μH , in this package size
- Handles high transient current spikes without saturation
- Ultra low buzz noise, due to composite construction
- Compliant to RoHS Directive 2002/95/EC



RoHS
 COMPLIANT
GREEN
 (5-2008)**

Note

** Please see document "Vishay Material Category Policy":
www.vishay.com/doc?99902

APPLICATIONS

- PDA/notebook/desktop/server applications
- High current POL converters
- Low profile, high current power supplies
- Battery powered devices
- DC/DC converters in distributed power systems
- DC/DC converter for Field Programmable Gate Array (FPGA)

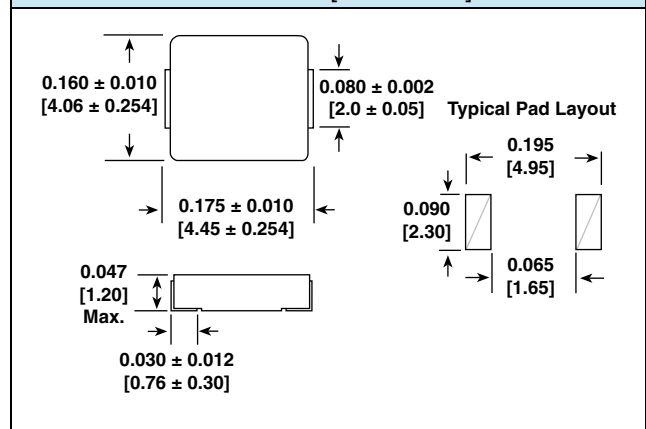
DIMENSIONS in inches [millimeters]

DESCRIPTION

IHLP-1616AB-01	0.47 μH	$\pm 20\%$	ER	e3
MODEL	INDUCTANCE VALUE	INDUCTANCE TOLERANCE	PACKAGE CODE	JEDEC LEAD (Pb)-FREE STANDARD

GLOBAL PART NUMBER

I	H	L	P	1	6	1	6	A	B	E	R	R	4	7	M	0	1
PRODUCT FAMILY				SIZE						PACKAGE CODE		INDUCTANCE VALUE		TOL.	SERIES		



PERFORMANCE GRAPHS

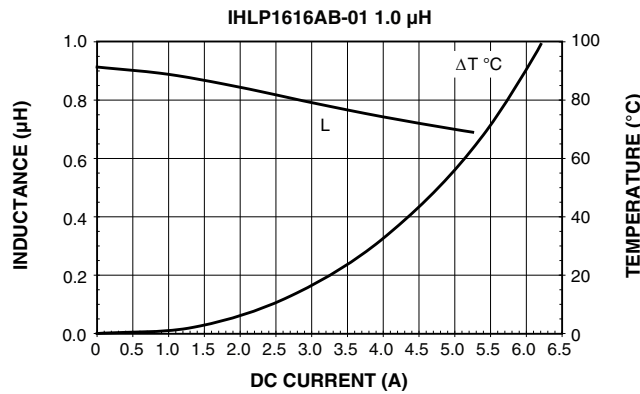
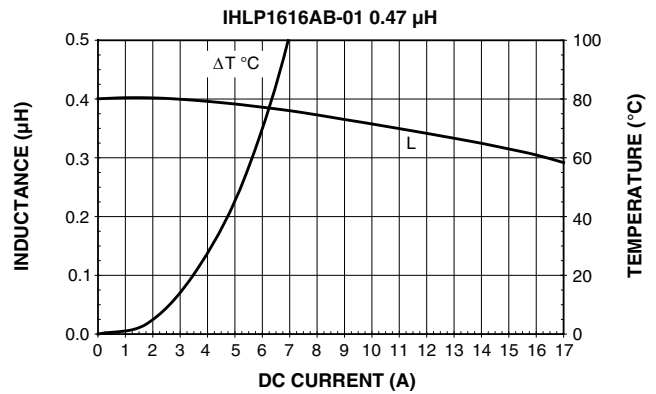
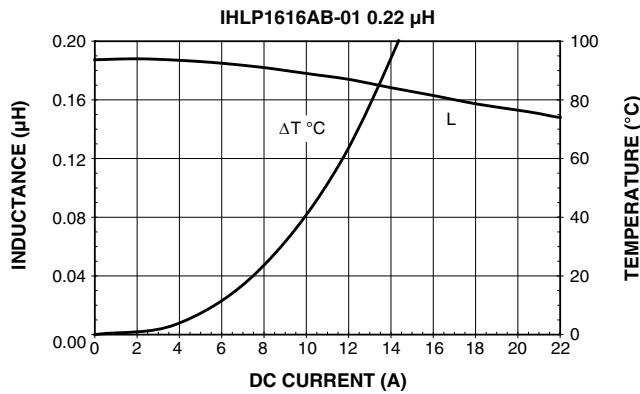
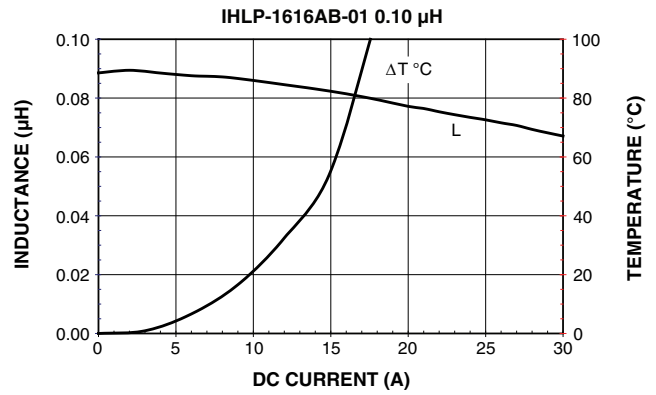
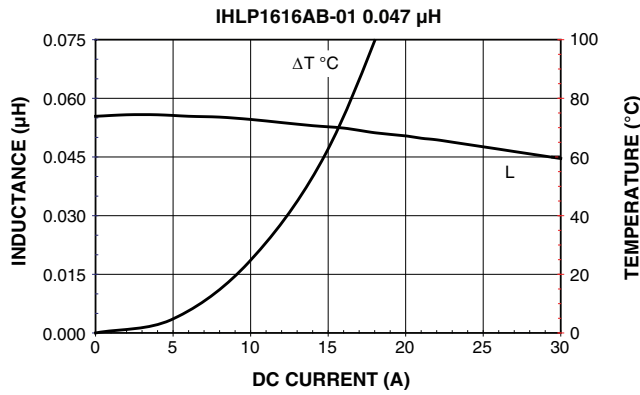



PERFORMANCE GRAPHS: INDUCTANCE AND Q VS. FREQUENCY

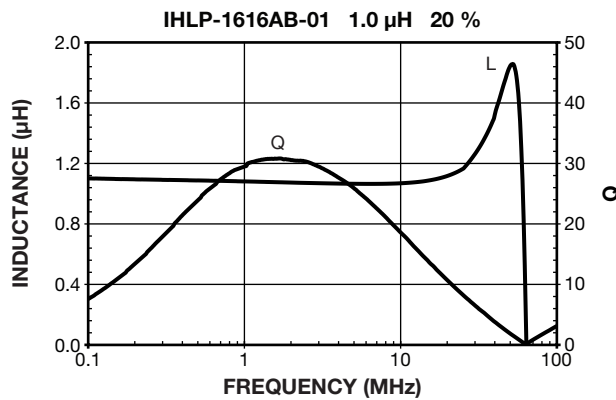
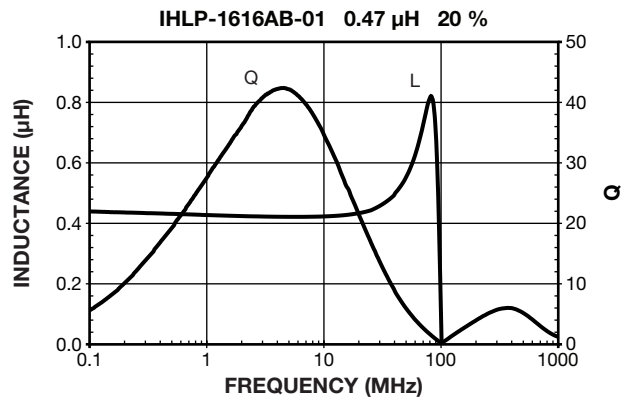
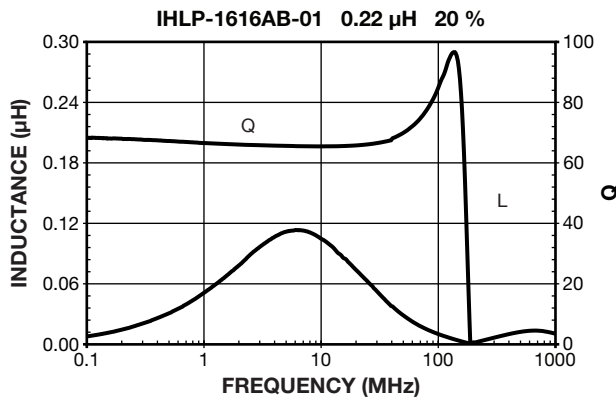
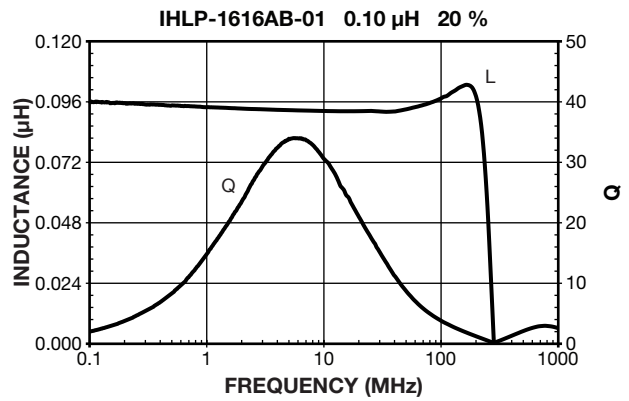
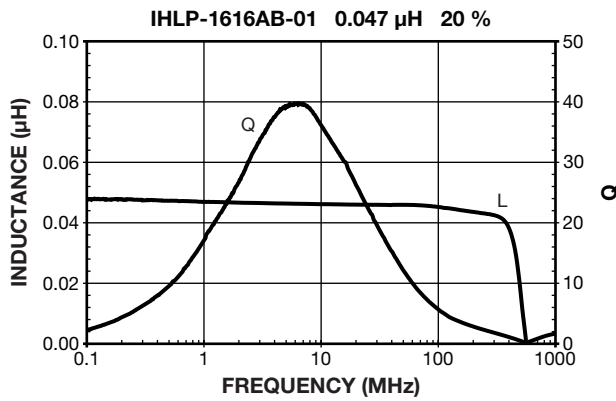

Low Profile, High Current IHLP® Inductors



Manufactured under one or more of the following:
US Patents; 6,198,375/6,204,744/6,449,829/6,460,244.
 Several foreign patents, and other patents pending.

STANDARD ELECTRICAL SPECIFICATIONS				
L ₀ INDUCTANCE ± 20 % AT 100 kHz, 0.25 V, 0 A (μH)	DCR TYP. 25 °C (mΩ)	DCR MAX. 25 °C (mΩ)	HEAT RATING CURRENT DC TYP. (A) ⁽³⁾	SATURATION CURRENT DC TYP. (A) ⁽⁴⁾
0.10	5.0	5.5	12.0	12.0
0.22	9.5	10.5	9.5	9.5
0.47	19	21	6.0	5.7
1.0	43	47	4.2	4.5
1.2	55.6	58.5	3.75	3.75
1.5	68	75	3.25	3.25
2.2	79.4	83.5	2.75	3.00

Notes

- (1) All test data is referenced to 25 °C ambient
- (2) Operating temperature range - 55 °C to + 125 °C
- (3) DC current (A) that will cause an approximate ΔT of 40 °C
- (4) DC current (A) that will cause L₀ to drop approximately 20 %
- (5) The part temperature (ambient + temp. rise) should not exceed 125 °C under worst case operating conditions. Circuit design, component placement, PWB trace size and thickness, airflow and other cooling provisions all affect the part temperature. Part temperature should be verified in the end application.

FEATURES

- Shielded construction
- Frequency range up to 1.0 MHz
- Lowest DCR/μH, in this package size
- Handles high transient current spikes without saturation
- Ultra low buzz noise, due to composite construction
- Compliant to RoHS Directive 2002/95/EC
- Halogen-free according to IEC 61249-2-21 definition



RoHS
 COMPLIANT
 HALOGEN
FREE

APPLICATIONS

- PDA/notebook/desktop/server applications
- High current POL converters
- Low profile, high current power supplies
- Battery powered devices
- DC/DC converters in distributed power systems
- DC/DC converter for Field Programmable Gate Array (FPGA)

DIMENSIONS in inches [millimeters]

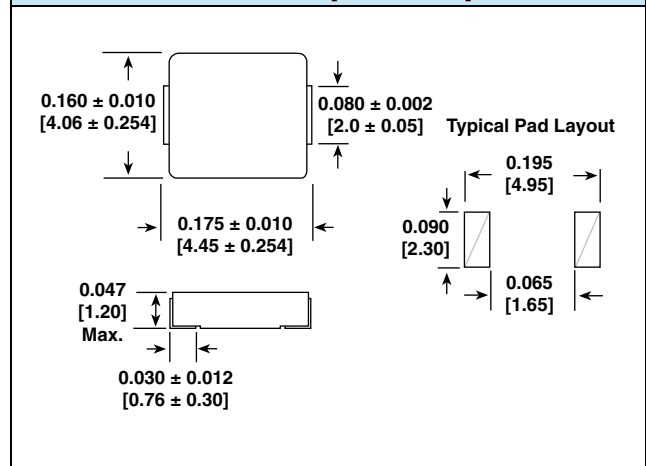

DESCRIPTION

IHLP-1616AB-11	2.2 μH	± 20 %	ER	e3
MODEL	INDUCTANCE VALUE	INDUCTANCE TOLERANCE	PACKAGE CODE	JEDEC LEAD (Pb)-FREE STANDARD

GLOBAL PART NUMBER

I	H	L	P	1	6	1	6	A	B	E	R	2	R	2	M	1	1
PRODUCT FAMILY				SIZE						PACKAGE CODE		INDUCTANCE VALUE		TOL.	SERIES		



PERFORMANCE GRAPHS

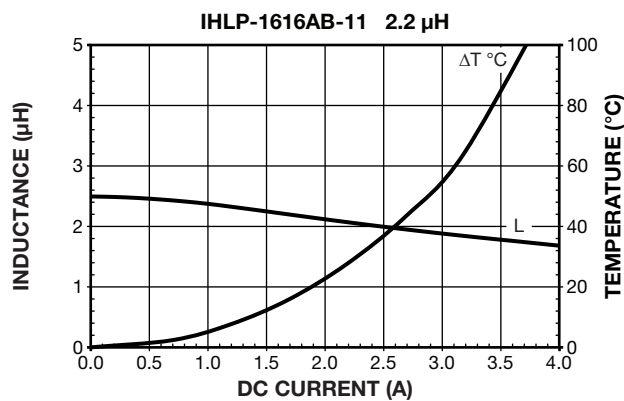
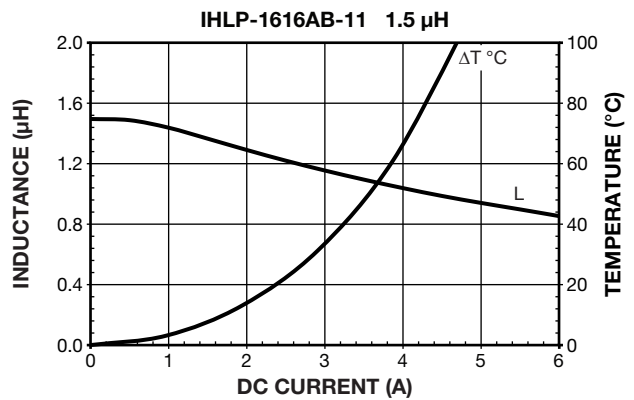
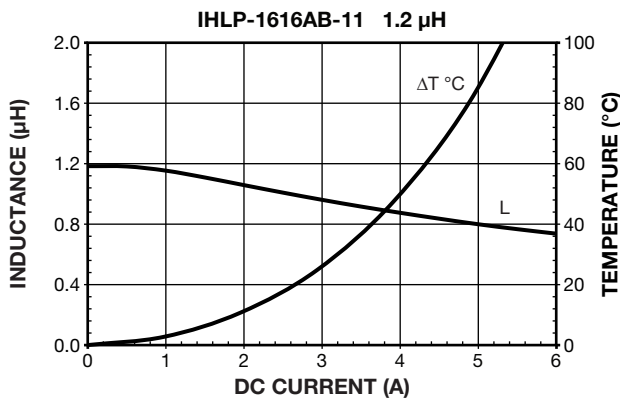
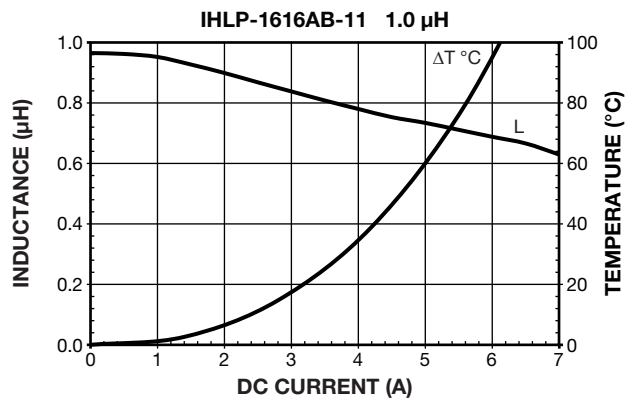
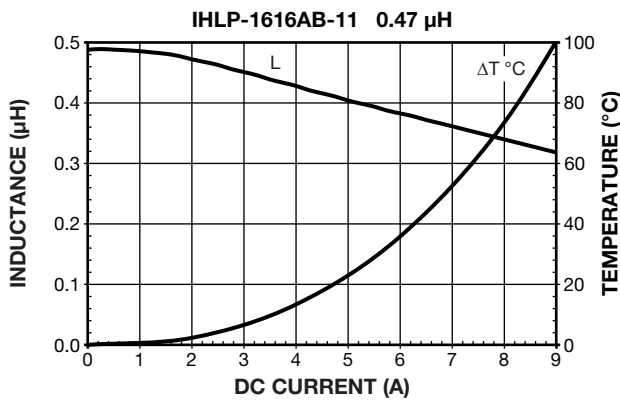
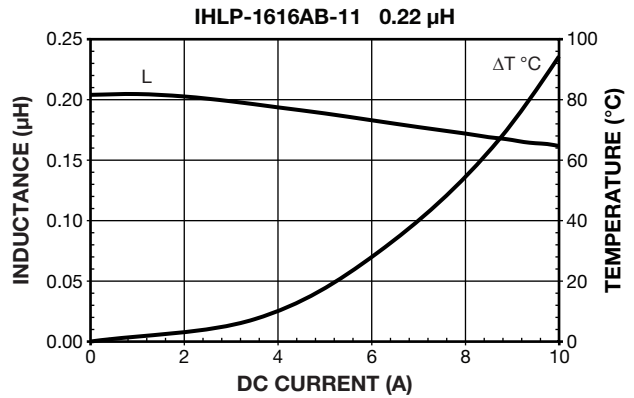
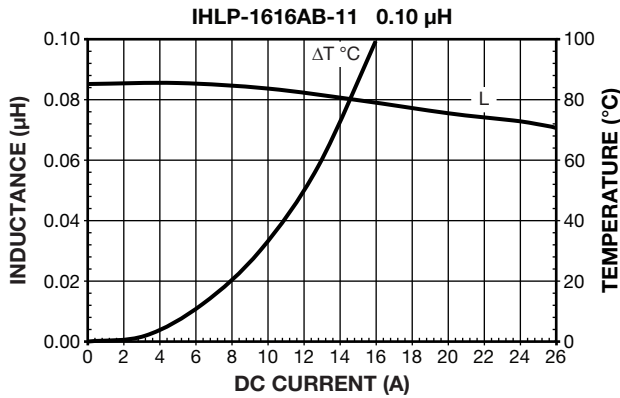



PERFORMANCE GRAPHS: INDUCTANCE AND Q VS. FREQUENCY

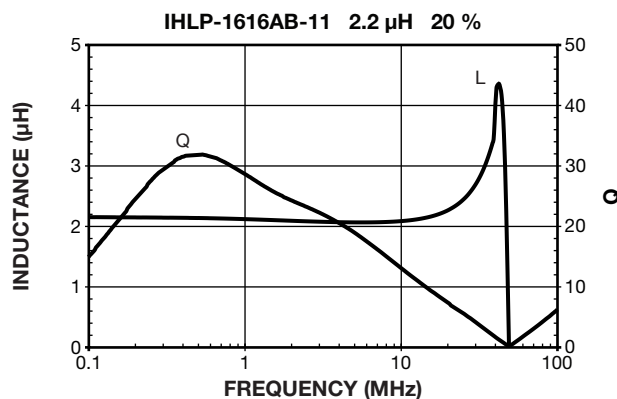
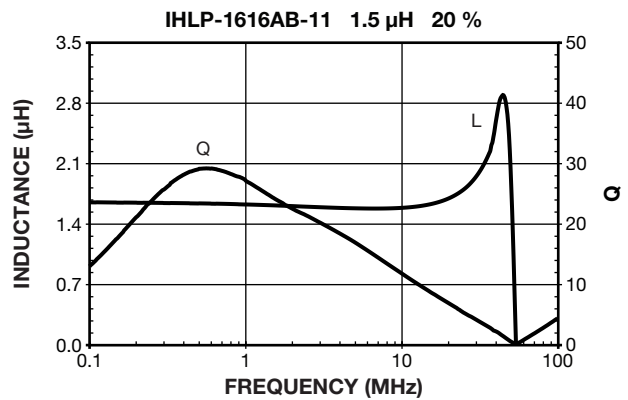
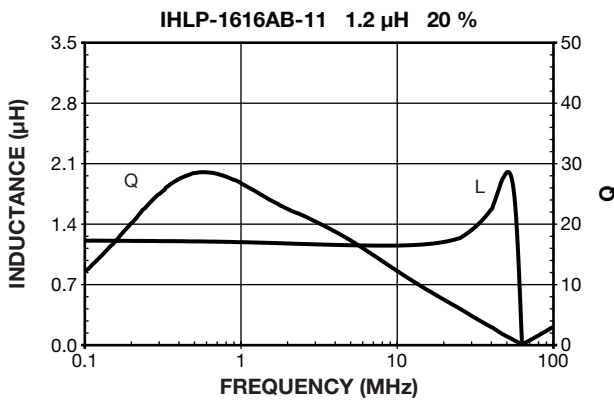
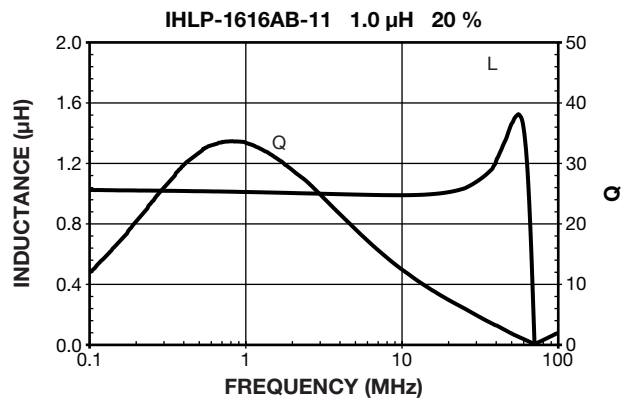
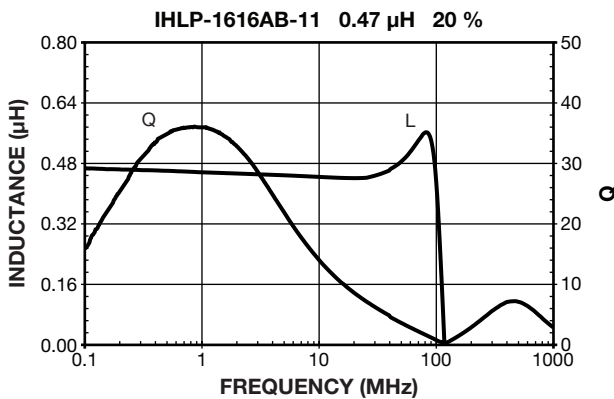
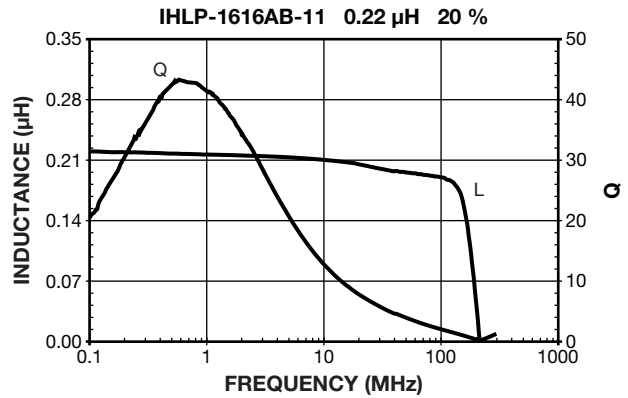
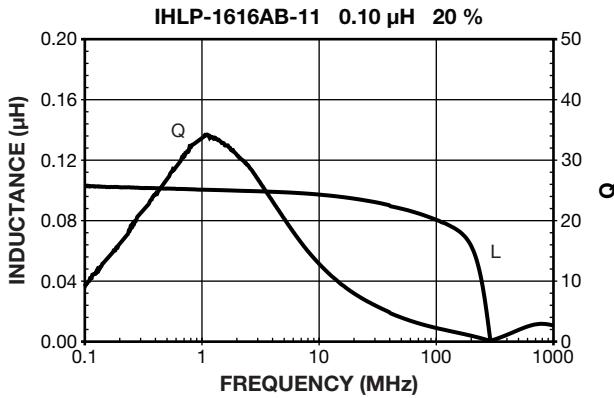

Low Profile, High Current IHLP® Inductors



Manufactured under one or more of the following:
US Patents; 6,198,375/6,204,744/6,449,829/6,460,244.
 Several foreign patents, and other patents pending.

STANDARD ELECTRICAL SPECIFICATIONS				
L ₀ INDUCTANCE ± 20 % AT 100 kHz, 0.25 V, 0 A (μH)	DCR TYP. 25 °C (mΩ)	DCR MAX. 25 °C (mΩ)	HEAT RATING CURRENT DC TYP. (A) ⁽³⁾	SATURATION CURRENT DC TYP. (A) ⁽⁴⁾
0.10	4.50	5.00	11.0	35.0
0.22	7.30	8.00	13.0	24.0
0.47	16.0	18.0	5.60	11.50
1.00	33.0	37.0	3.75	8.50
2.20	80.0	90.0	2.85	6.00

Notes

- (1) All test data is referenced to 25 °C ambient
- (2) Operating temperature range - 55 °C to + 125 °C
- (3) DC current (A) that will cause an approximate ΔT of 40 °C
- (4) DC current (A) that will cause L₀ to drop approximately 20 %
- (5) The part temperature (ambient + temp. rise) should not exceed 125 °C under worst case operating conditions. Circuit design, component placement, PWB trace size and thickness, airflow and other cooling provisions all affect the part temperature. Part temperature should be verified in the end application.

FEATURES

- Shielded construction
- Frequency range up to 5.0 MHz
- Lowest DCR/μH, in this package size
- Handles high transient current spikes without saturation
- Ultra low buzz noise, due to composite construction
- Compliant to RoHS Directive 2002/95/EC



RoHS
 COMPLIANT
GREEN
 (5-2008)**

APPLICATIONS

- PDA/notebook/desktop/server applications
- High current POL converters
- Low profile, high current power supplies
- Battery powered devices
- DC/DC converters in distributed power systems
- DC/DC converter for Field Programmable Gate Array (FPGA)

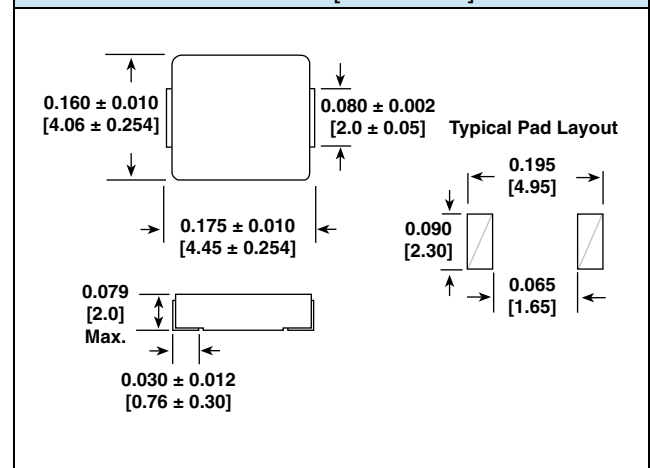
DIMENSIONS in inches [millimeters]

DESCRIPTION

IHLP-1616BZ-01	0.47 μH	± 20 %	ER	e3
MODEL	INDUCTANCE VALUE	INDUCTANCE TOLERANCE	PACKAGE CODE	JEDEC LEAD (Pb)-FREE STANDARD

GLOBAL PART NUMBER

I	H	L	P	1	6	1	6	B	Z	E	R	R	4	7	M	0	1
PRODUCT FAMILY				SIZE						PACKAGE CODE		INDUCTANCE VALUE			TOL.	SERIES	

** Please see document "Vishay Material Category Policy": www.vishay.com/doc?99902

PERFORMANCE GRAPHS

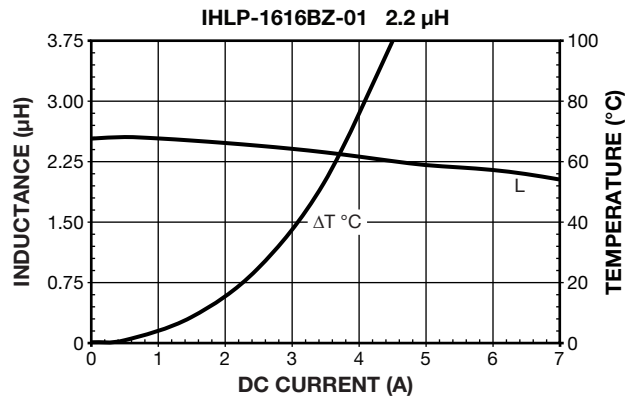
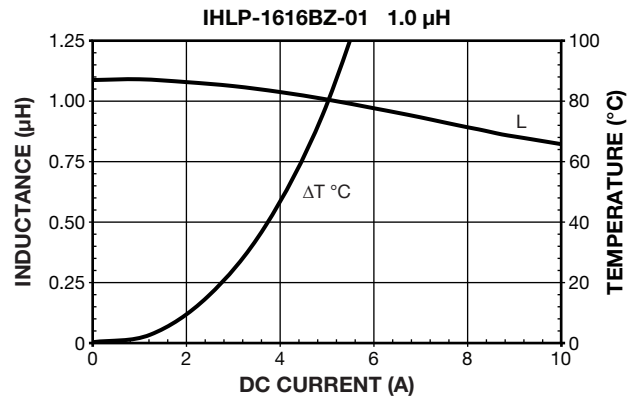
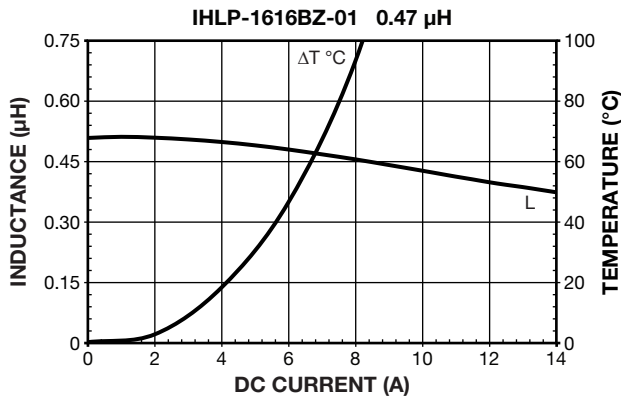
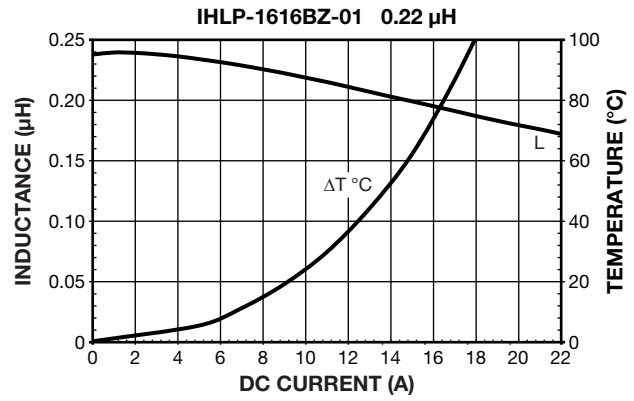
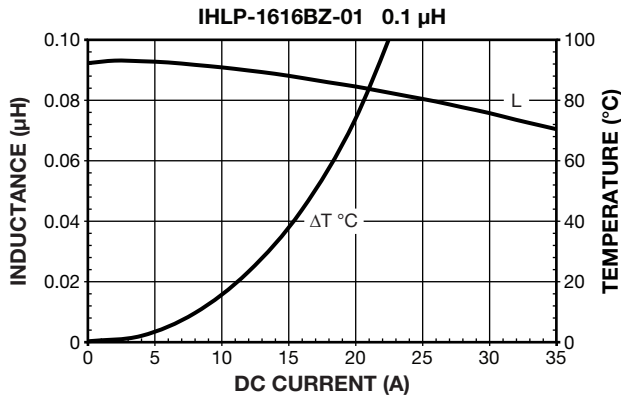



PERFORMANCE GRAPHS: INDUCTANCE AND Q VS. FREQUENCY

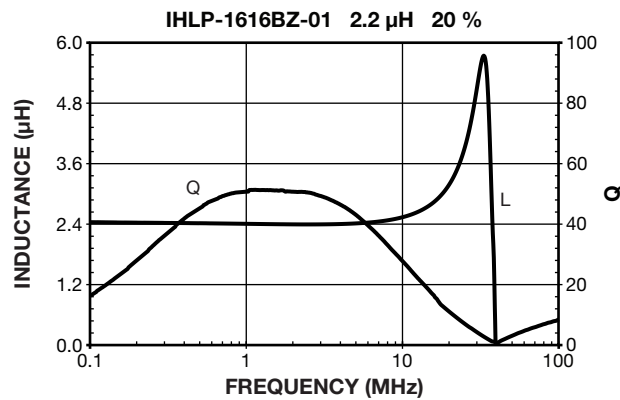
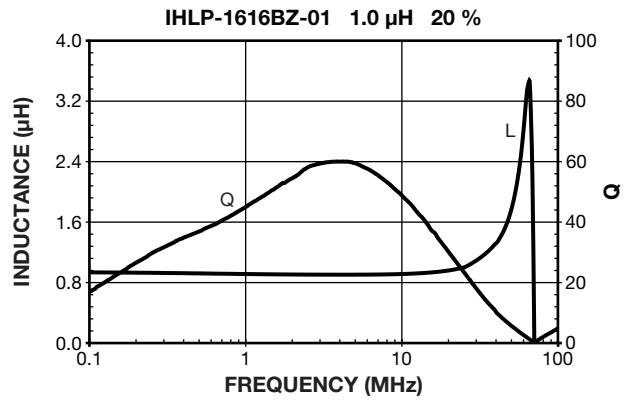
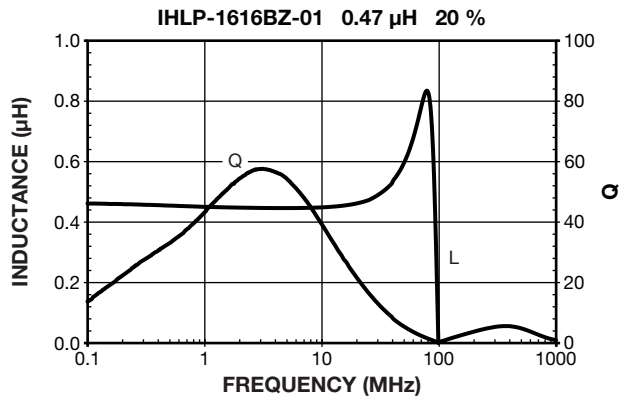
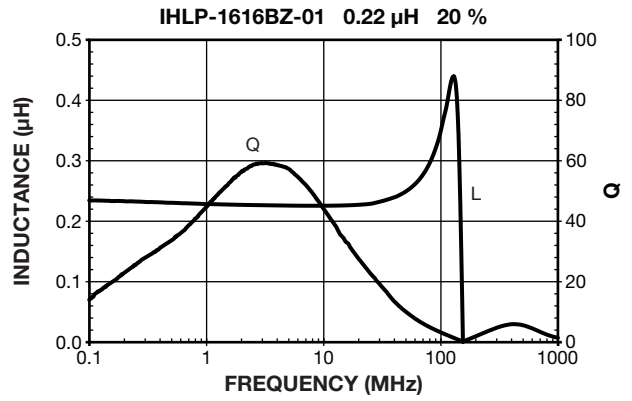
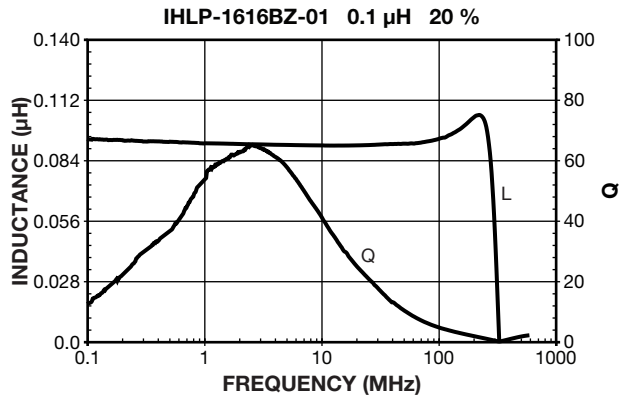

Low Profile, High Current IHLP® Inductors



Manufactured under one or more of the following:
US Patents; 6,198,375/6,204,744/6,449,829/6,460,244.
 Several foreign patents, and other patents pending.

STANDARD ELECTRICAL SPECIFICATIONS				
L ₀ INDUCTANCE ± 20 % AT 100 kHz, 0.25 V, 0 A (μH)	DCR TYP. 25 °C (mΩ)	DCR MAX. 25 °C (mΩ)	HEAT RATING CURRENT DC TYP. (A) ⁽³⁾	SATURATION CURRENT DC TYP. (A) ⁽⁴⁾
0.10	4.1	4.5	12.0	12.0
0.22	6.5	7.0	9.0	9.0
0.47	14.5	16	7.0	7.0
1.0	24	27	4.5	5.0
2.2	61	68	3.25	3.25
4.7	95	105	1.7	1.75

Notes

- (1) All test data is referenced to 25 °C ambient
- (2) Operating temperature range - 55 °C to + 125 °C
- (3) DC current (A) that will cause an approximate ΔT of 40 °C
- (4) DC current (A) that will cause L₀ to drop approximately 20 %
- (5) The part temperature (ambient + temp. rise) should not exceed 125 °C under worst case operating conditions. Circuit design, component placement, PWB trace size and thickness, airflow and other cooling provisions all affect the part temperature. Part temperature should be verified in the end application.

FEATURES

- Shielded construction
- Frequency range up to 1.0 MHz
- Lowest DCR/μH, in this package size
- Handles high transient current spikes without saturation
- Ultra low buzz noise, due to composite construction
- Compliant to RoHS Directive 2002/95/EC
- Halogen-free according to IEC 61249-2-21 definition



RoHS
 COMPLIANT
 HALOGEN
FREE

APPLICATIONS

- PDA/notebook/desktop/server applications
- High current POL converters
- Low profile, high current power supplies
- Battery powered devices
- DC/DC converters in distributed power systems
- DC/DC converter for Field Programmable Gate Array (FPGA)

DIMENSIONS in inches [millimeters]

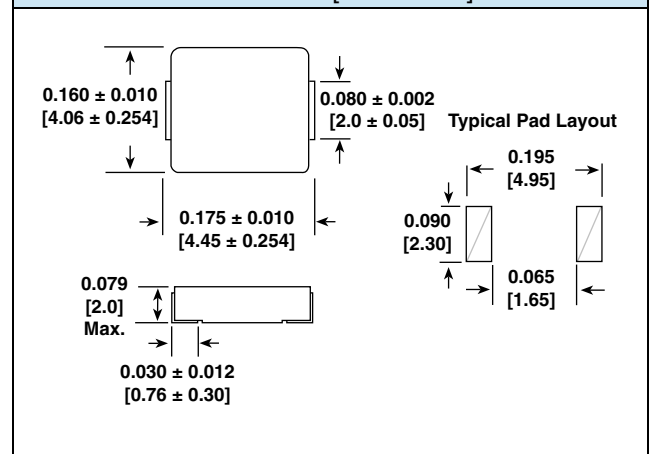

DESCRIPTION

IHLP-1616BZ-11	4.7 μH	± 20 %	ER	e3
MODEL	INDUCTANCE VALUE	INDUCTANCE TOLERANCE	PACKAGE CODE	JEDEC LEAD (Pb)-FREE STANDARD

GLOBAL PART NUMBER

I	H	L	P	1	6	1	6	B	Z	E	R	4	R	7	M	1	1
PRODUCT FAMILY				SIZE				PACKAGE CODE		INDUCTANCE VALUE			TOL.	SERIES			

PERFORMANCE GRAPHS

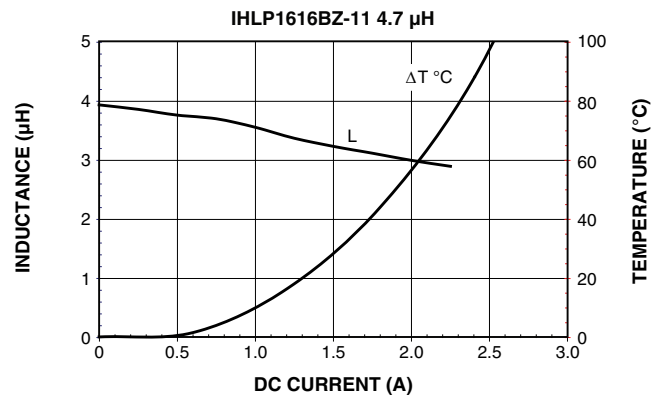
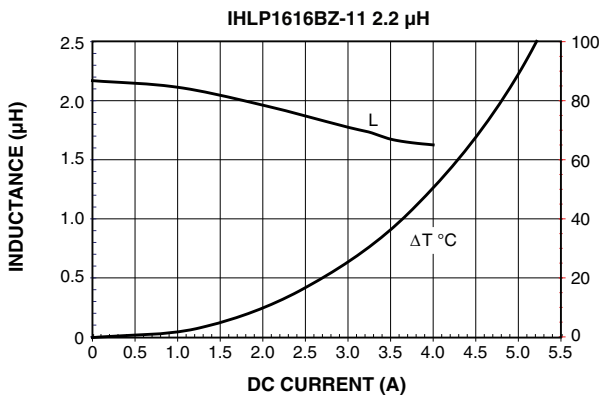
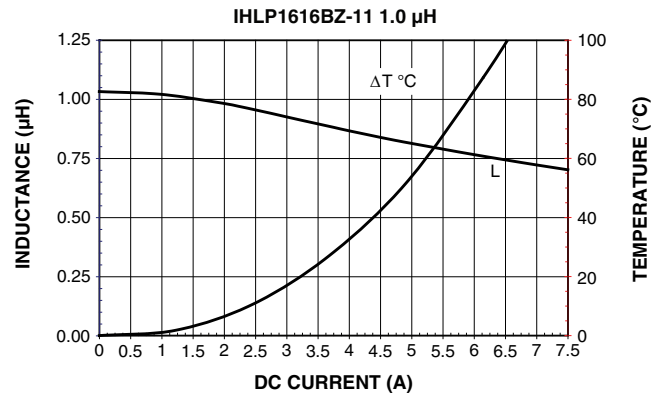
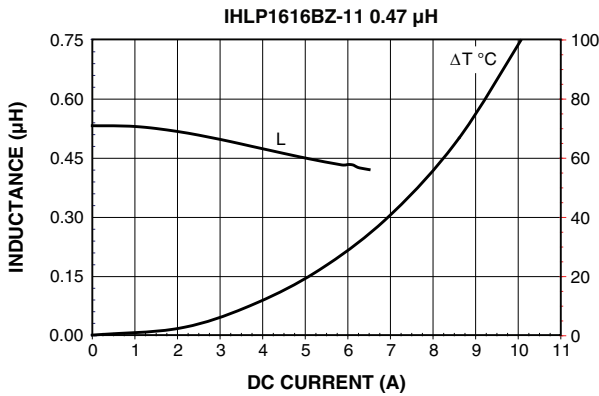
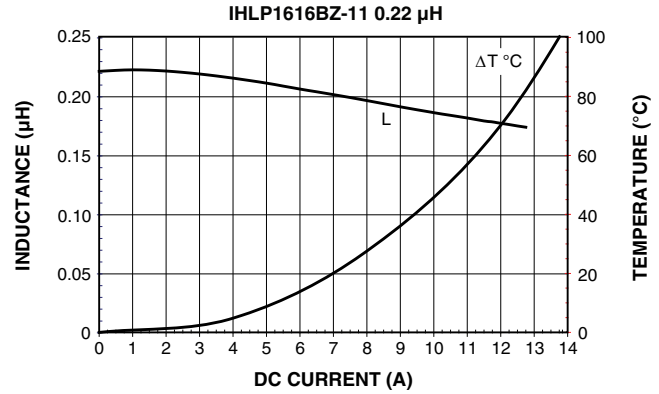
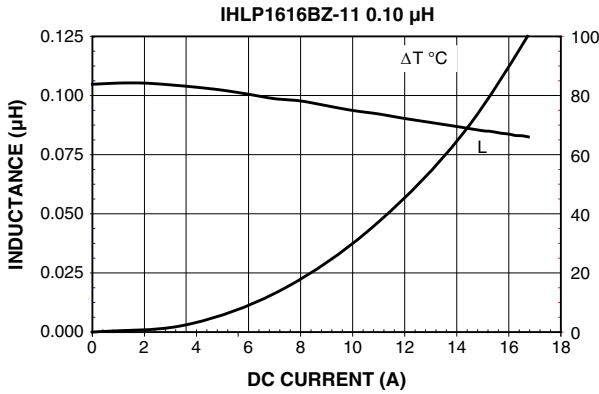

Low Profile, High Current IHLP® Inductor

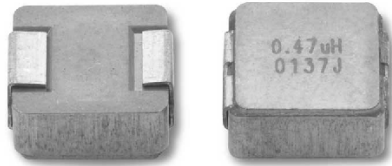

Manufactured under one or more of the following:
US Patents; 6,198,375/6,204,744/6,449,829/6,460,244.
 Several foreign patents, and other patents pending.



RoHS
 COMPLIANT
GREEN
 (5-2008)**

FEATURES

- Shielded construction
- Frequency range up to 5.0 MHz
- Lowest DCR/µH, in this package size
- Handles high transient current spikes without saturation
- Ultra low buzz noise, due to composite construction
- Compliant to RoHS Directive 2002/95/EC

Note

** Please see document "Vishay Material Category Policy":
www.vishay.com/doc?99902

STANDARD ELECTRICAL SPECIFICATIONS

L_0 INDUCTANCE ± 20 % AT 100 kHz, 0.25 V, 0 A (µH)	DCR TYP. 25 °C (mΩ)	DCR MAX. 25 °C (mΩ)	HEAT RATING CURRENT DC TYP. (A) ⁽³⁾	SATURATION CURRENT DC TYP. (A) ⁽⁴⁾
0.10	3.6	3.9	17.0	45.0
0.22	4.9	5.2	15.0	22.0
0.33	7.6	8.2	12.0	25.0
0.47	8.9	9.4	11.5	21.0
0.68	11.2	12.4	10.0	15.0
1.0	18.9	20.0	7.0	16.0
2.2	45.6	50.1	4.2	9.5
3.3	79.2	85.5	3.3	8.5
4.7	108.0	116.6	2.8	5.0
5.6	113.0	122.0	2.5	4.5
6.8	139.0	150.0	2.4	4.3
10	184.0	199.0	2.3	4.0

Notes

- (1) All test data is referenced to 25 °C ambient
- (2) Operating temperature range - 55 °C to + 125 °C
- (3) DC current (A) that will cause an approximate ΔT of 40 °C
- (4) DC current (A) that will cause L_0 to drop approximately 20 %
- (5) The part temperature (ambient + temp. rise) should not exceed 125 °C under worst case operating conditions. Circuit design, component placement, PWB trace size and thickness, airflow and other cooling provisions all affect the part temperature. Part temperature should be verified in the end application.

APPLICATIONS

- PDA/notebook/desktop/server applications
- High current POL converters
- Low profile, high current power supplies
- Battery powered devices
- DC/DC converters in distributed power systems
- DC/DC converter for Field Programmable Gate Array (FPGA)

DIMENSIONS in inches [millimeters]

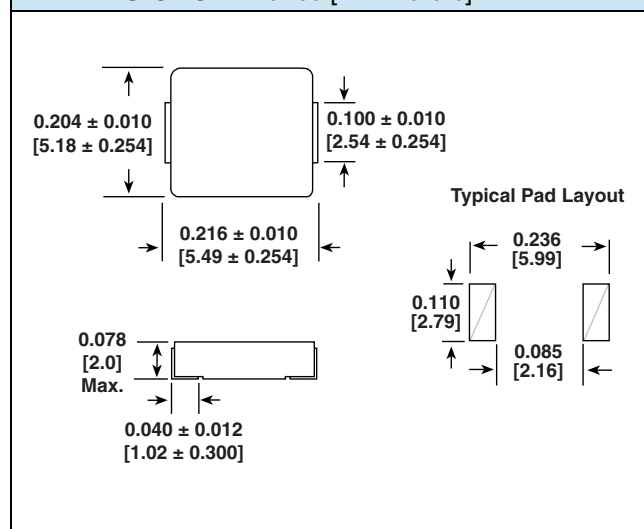

DESCRIPTION

IHLP-2020BZ-01	4.7 µH	± 20 %	ER	e3
MODEL	INDUCTANCE VALUE	INDUCTANCE TOLERANCE	PACKAGE CODE	JEDEC LEAD (Pb)-FREE STANDARD

GLOBAL PART NUMBER

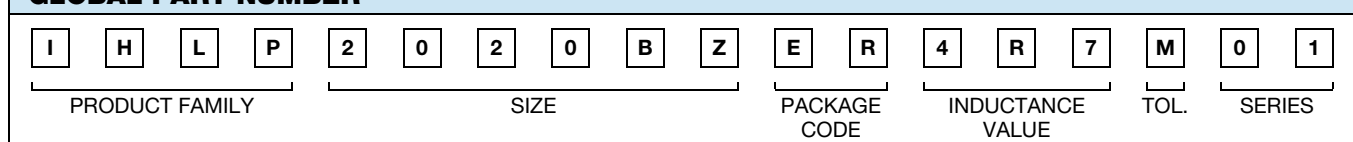



PERFORMANCE GRAPHS

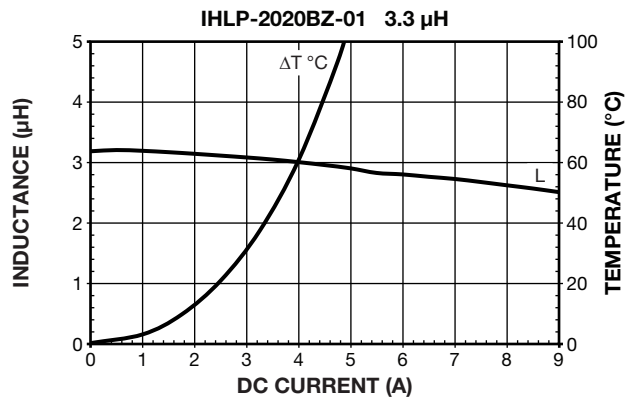
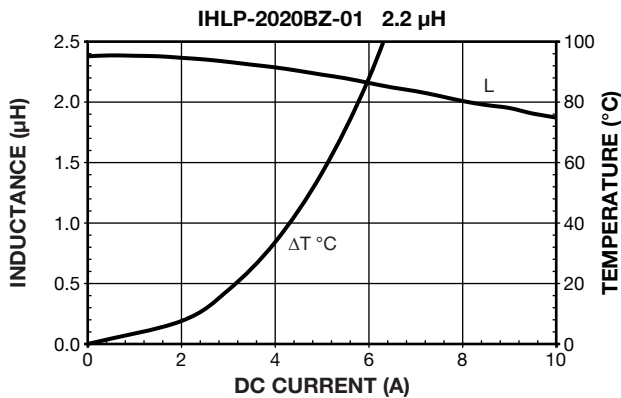
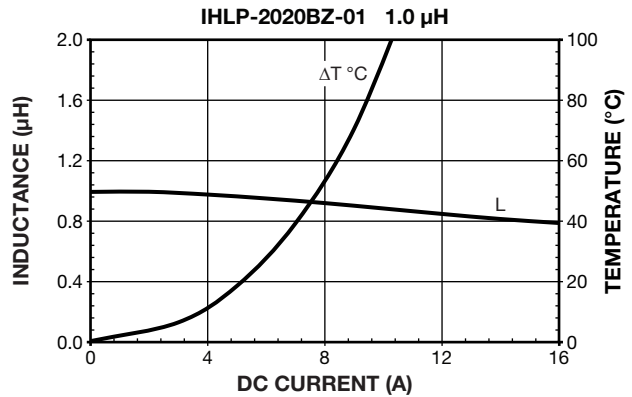
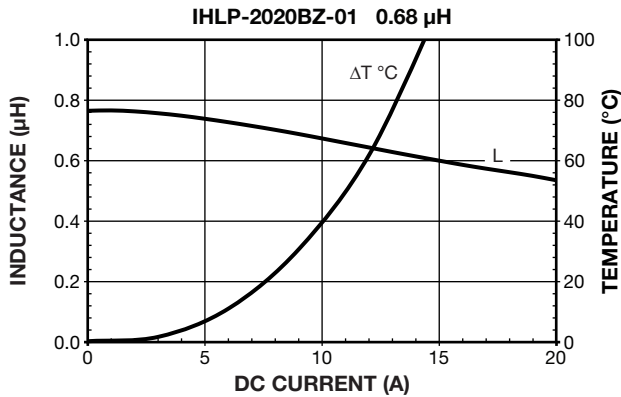
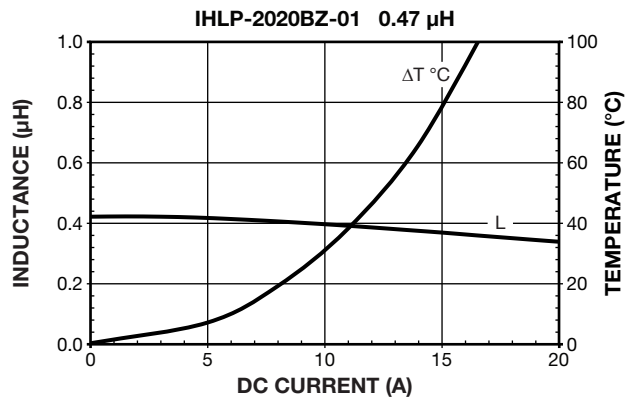
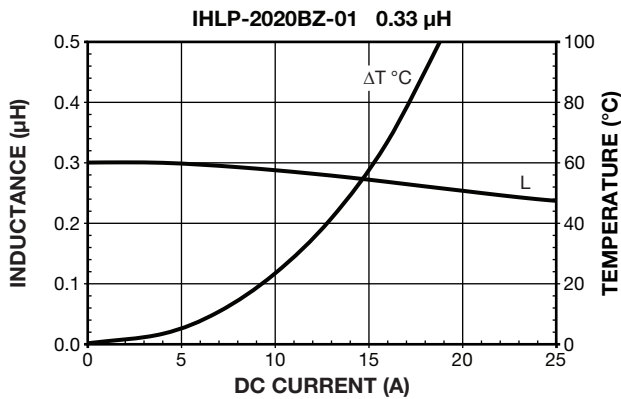
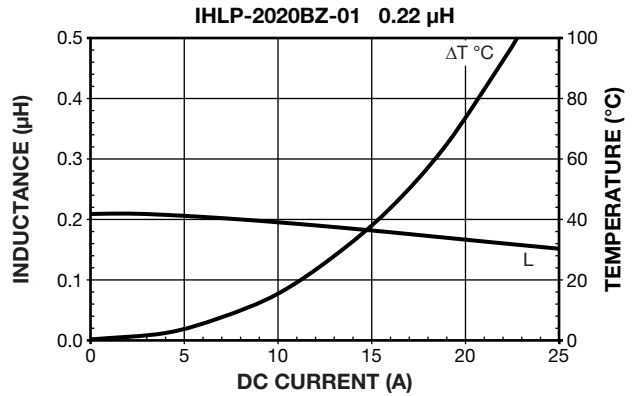
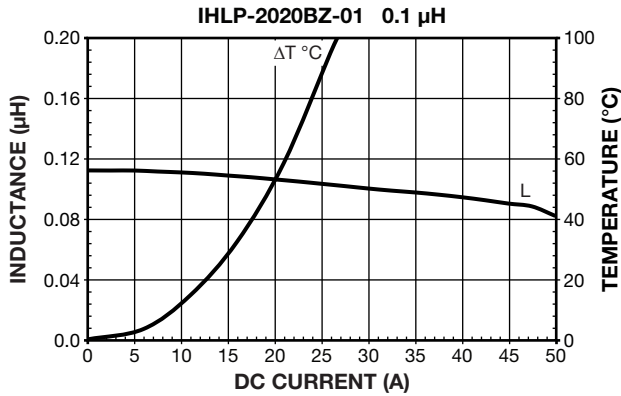



PERFORMANCE GRAPHS

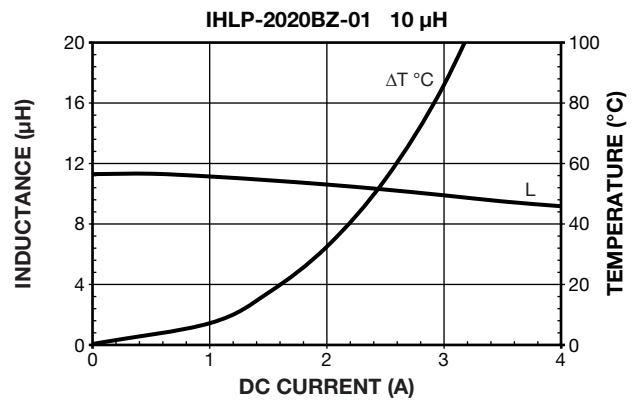
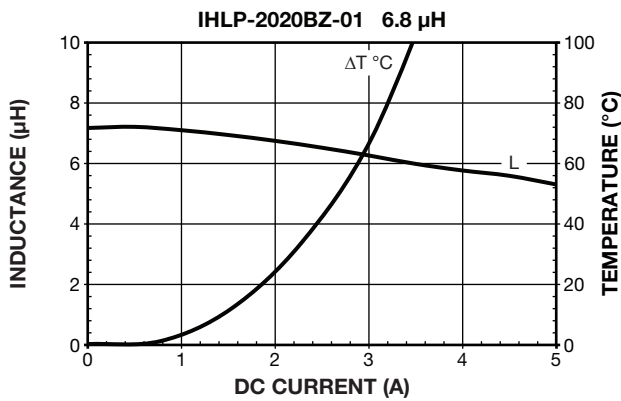
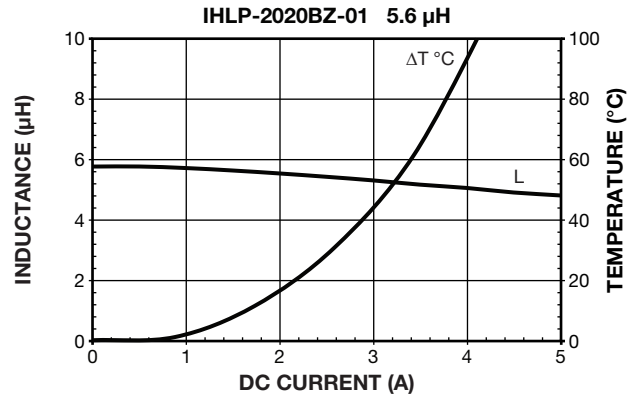
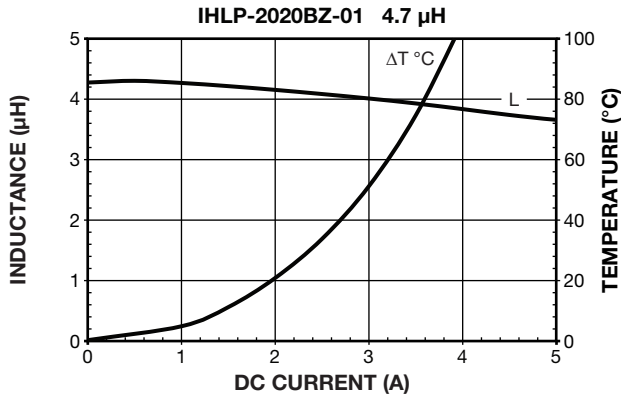



PERFORMANCE GRAPHS: INDUCTANCE AND Q VS. FREQUENCY

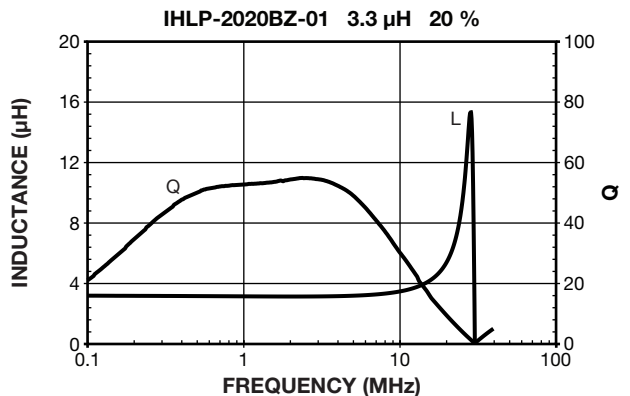
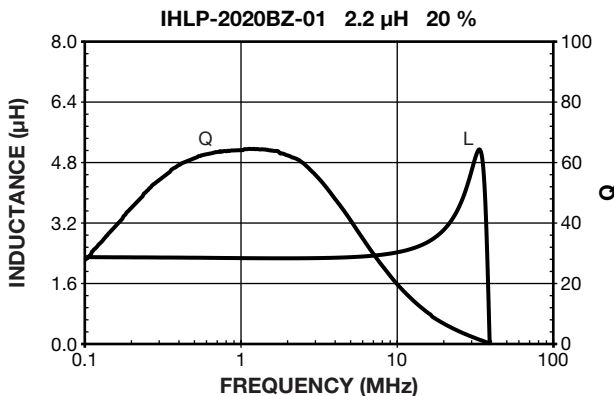
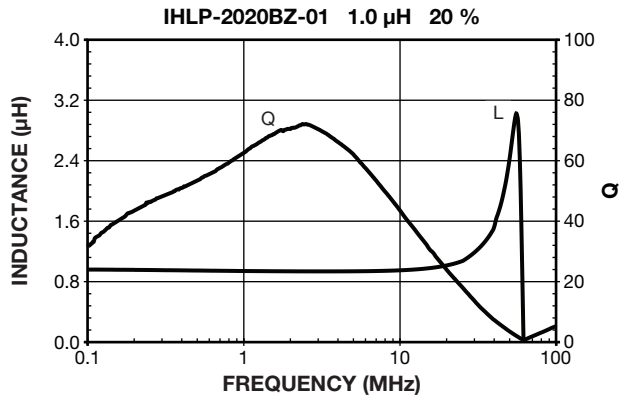
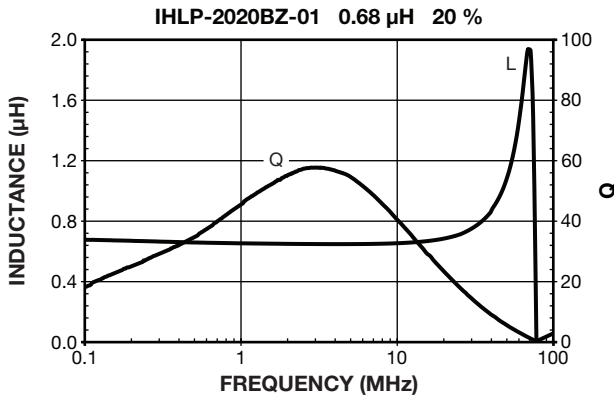
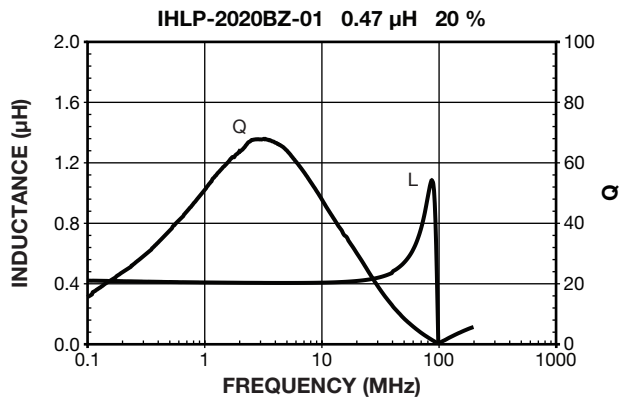
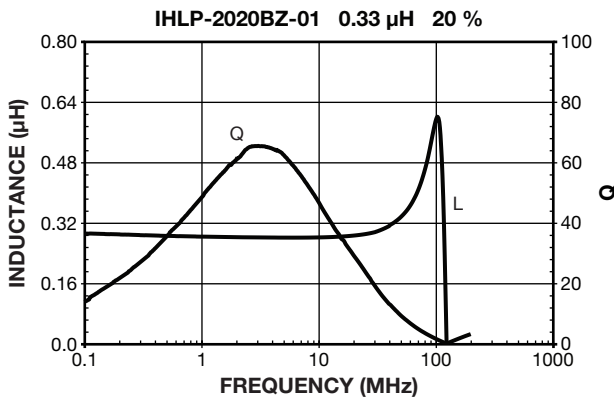
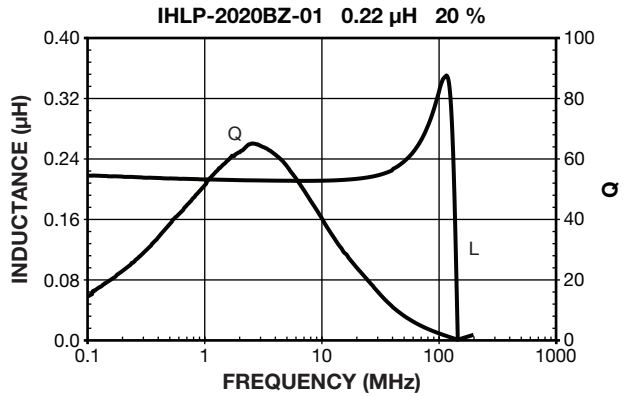
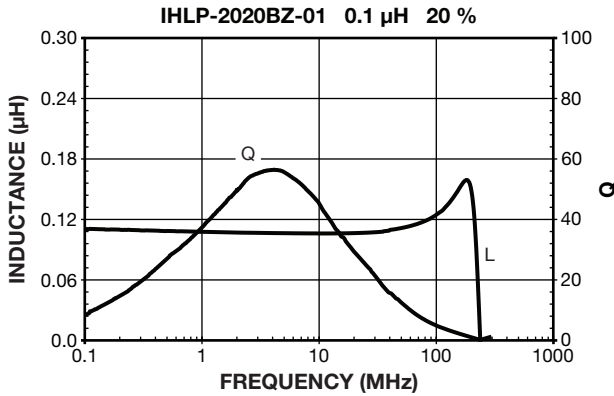



PERFORMANCE GRAPHS: INDUCTANCE AND Q VS. FREQUENCY

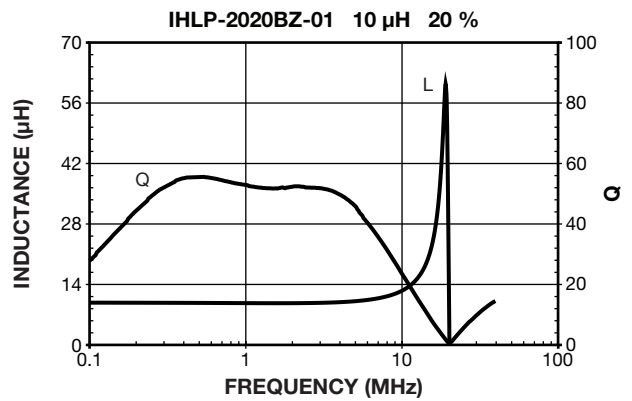
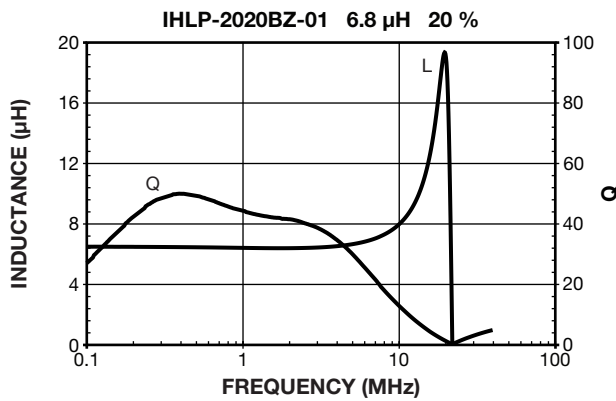
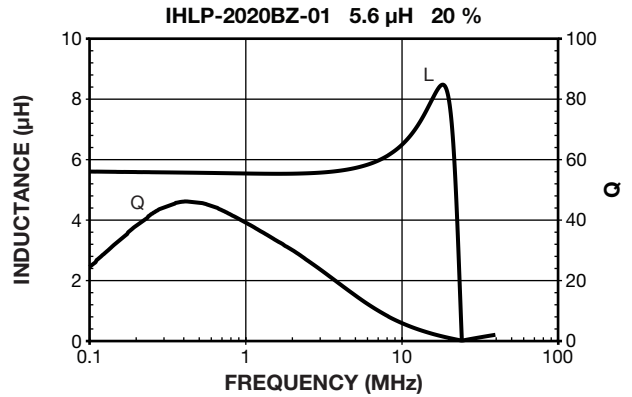
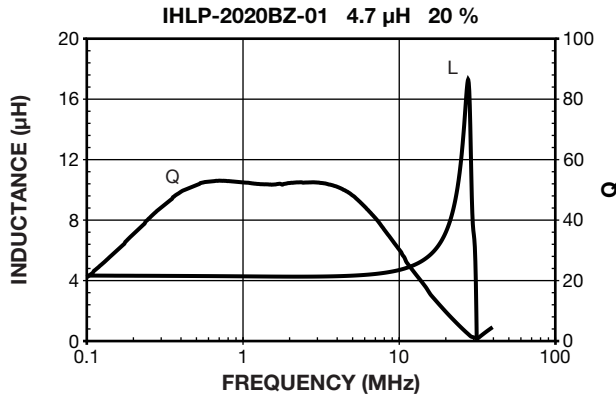

Low Profile, High Current IHLP® Inductors

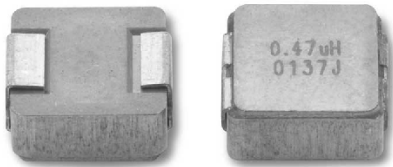

Manufactured under one or more of the following:
US Patents; 6,198,375/6,204,744/6,449,829/6,460,244.
 Several foreign patents, and other patents pending.

STANDARD ELECTRICAL SPECIFICATIONS				
L_0 INDUCTANCE $\pm 20\%$ AT 100 kHz, 0.25 V, 0 A (μH)	DCR TYP. 25 °C ($\text{m}\Omega$)	DCR MAX. 25 °C ($\text{m}\Omega$)	HEAT RATING CURRENT DC TYP. (A) ⁽³⁾	SATURATION CURRENT DC TYP. (A) ⁽⁴⁾
0.10	2.7	2.9	21.0	25.0
0.22	4.1	4.5	17.0	13.0
0.33	5.5	5.9	13.0	7.5
0.47	7.1	7.7	12.5	8.0
1.0	16.8	18.1	7.5	7.0
2.2	34.9	37.7	5.0	5.5
3.3	53.5	57.8	4.1	4.7
4.7	75.3	81.3	3.2	3.0
5.6	85.2	92.0	3.0	2.2
6.8	114.0	121.0	2.8	2.1
10.0	169.3	182.8	2.2	2.0

Notes

- (1) All test data is referenced to 25 °C ambient
- (2) Operating temperature range - 55 °C to + 125 °C
- (3) DC current (A) that will cause an approximate ΔT of 40 °C
- (4) DC current (A) that will cause L_0 to drop approximately 20 %
- (5) The part temperature (ambient + temp. rise) should not exceed 125 °C under worst case operating conditions. Circuit design, component placement, PWB trace size and thickness, airflow and other cooling provisions all affect the part temperature. Part temperature should be verified in the end application.

FEATURES

- Shielded construction
- Frequency range up to 1.0 MHz
- Lowest DCR/ μH , in this package size
- Handles high transient current spikes without saturation
- Ultra low buzz noise, due to composite construction
- Compliant to RoHS Directive 2002/95/EC
- Halogen-free according to IEC 61249-2-21 definition



RoHS
COMPLIANT
HALOGEN
FREE

APPLICATIONS

- PDA/notebook/desktop/server applications
- High current POL converters
- Low profile, high current power supplies
- Battery powered devices
- DC/DC converters in distributed power systems
- DC/DC converter for Field Programmable Gate Array (FPGA)

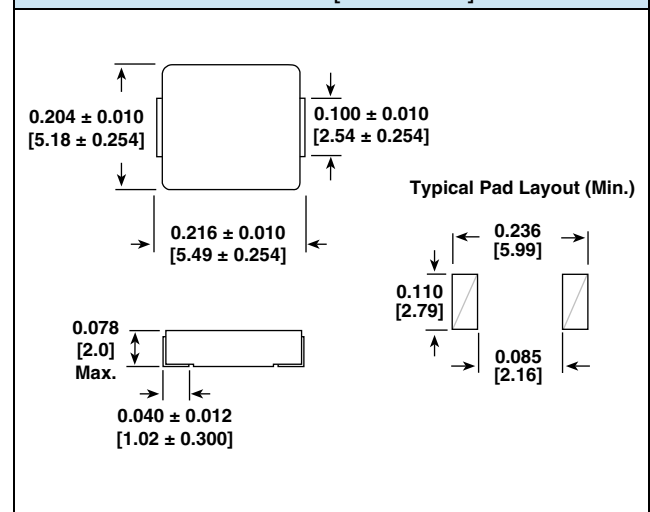
DIMENSIONS in inches [millimeters]

DESCRIPTION

IHLP-2020BZ-11	4.7 μH	$\pm 20\%$	ER	e3
MODEL	INDUCTANCE VALUE	INDUCTANCE TOLERANCE	PACKAGE CODE	JEDEC LEAD (Pb)-FREE STANDARD

GLOBAL PART NUMBER

I	H	L	P	2	0	2	0	B	Z	E	R	4	R	7	M	1	1
PRODUCT FAMILY				SIZE				PACKAGE CODE		INDUCTANCE VALUE			TOL.	SERIES			

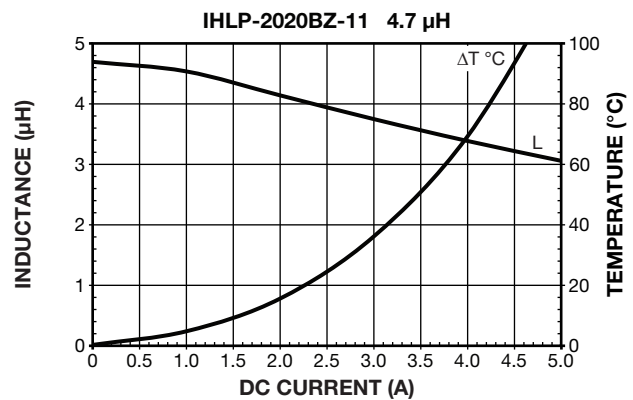
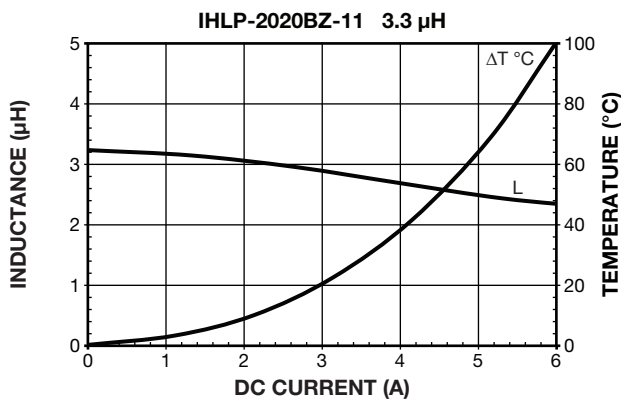
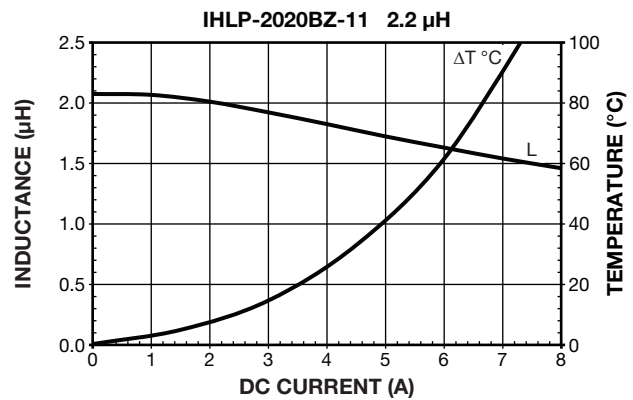
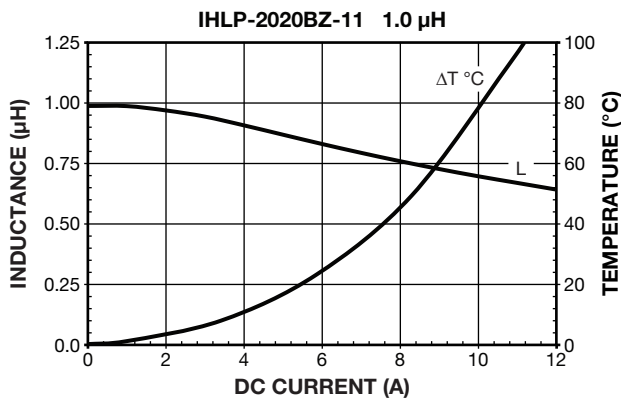
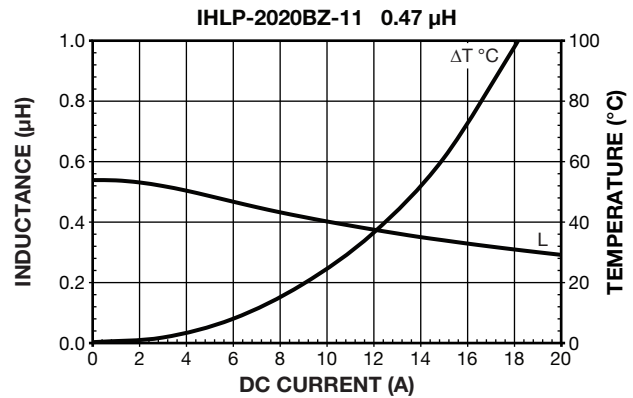
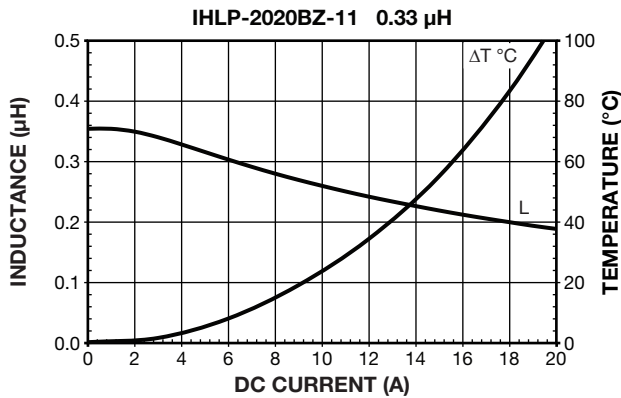
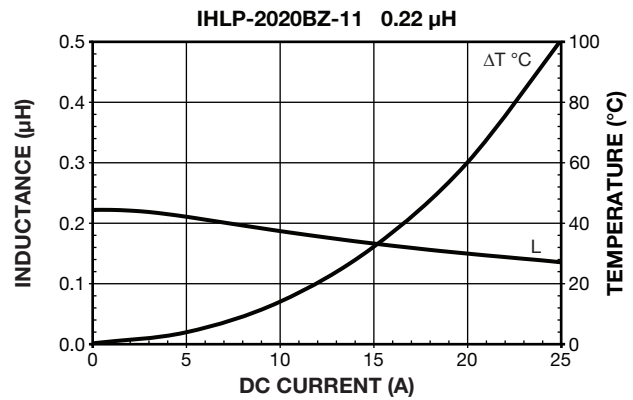
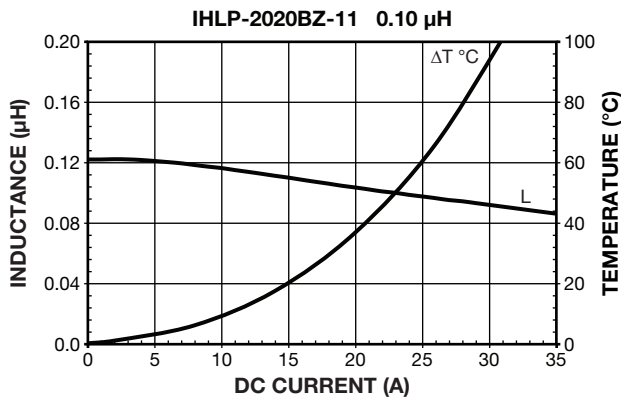
PERFORMANCE GRAPHS





PERFORMANCE GRAPHS

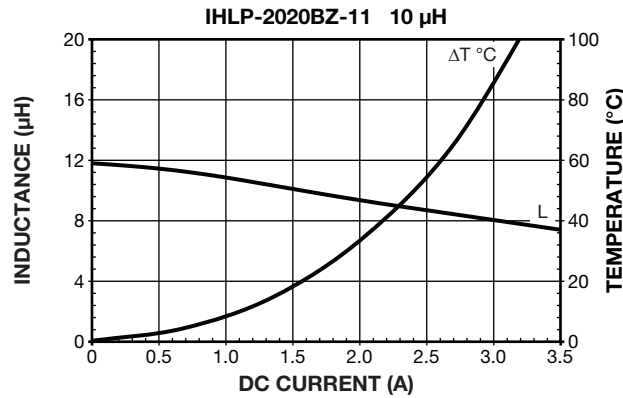
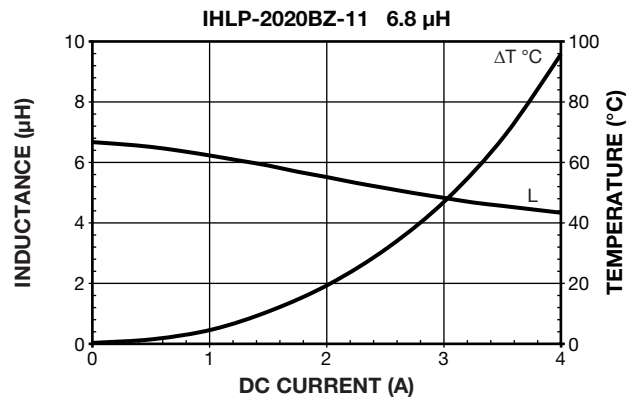
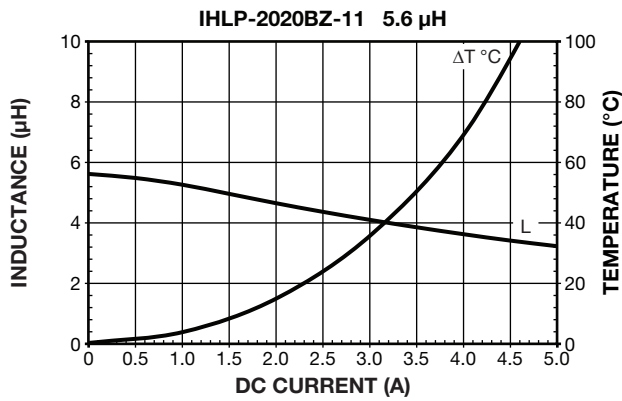

PERFORMANCE GRAPHS: INDUCTANCE AND Q VS. FREQUENCY

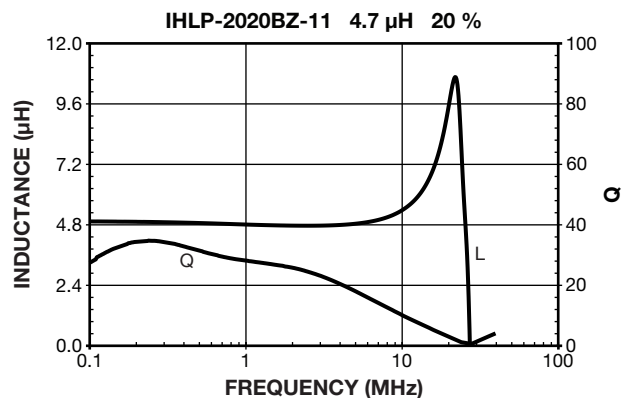
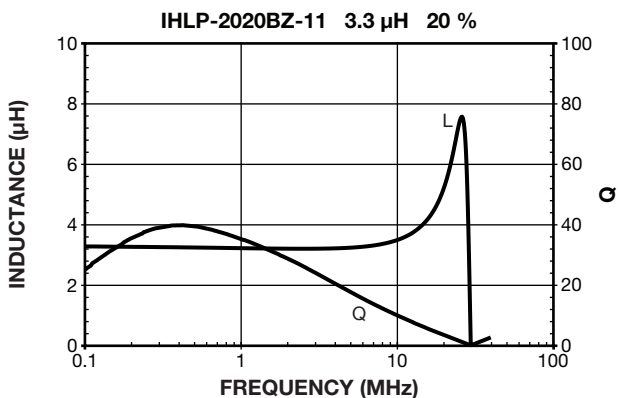
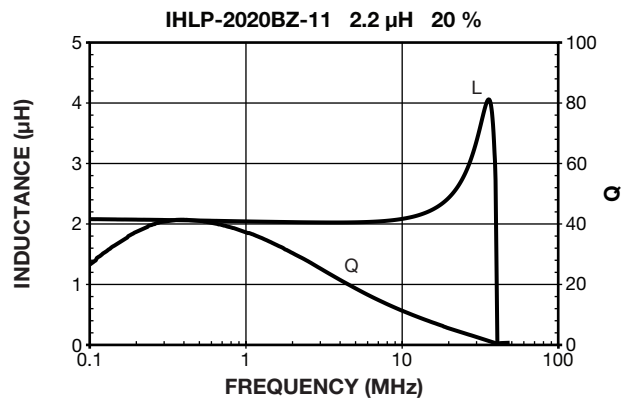
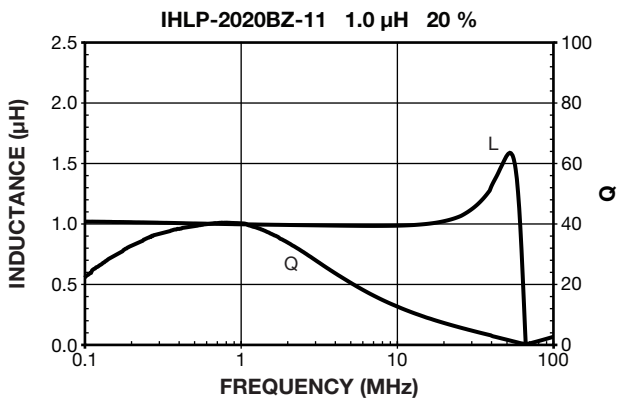
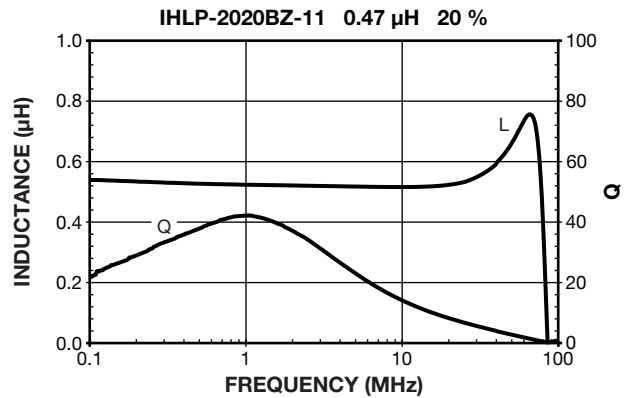
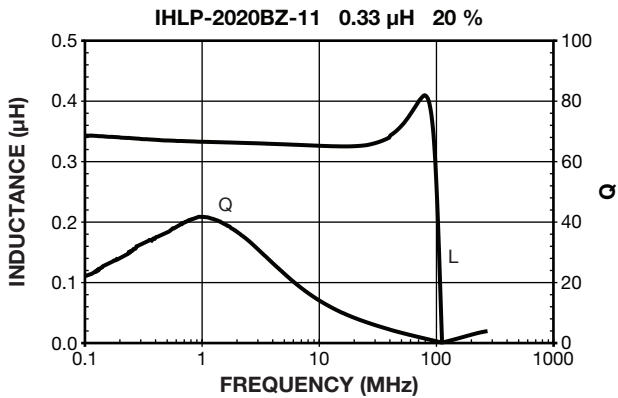
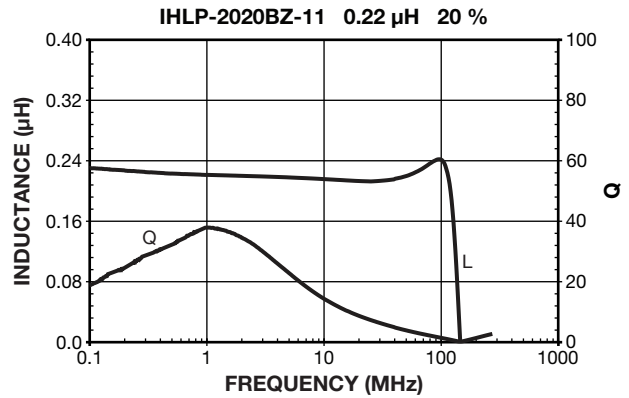
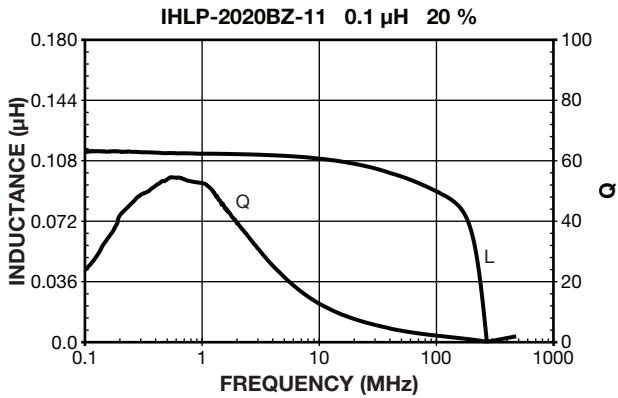



PERFORMANCE GRAPHS: INDUCTANCE AND Q VS. FREQUENCY

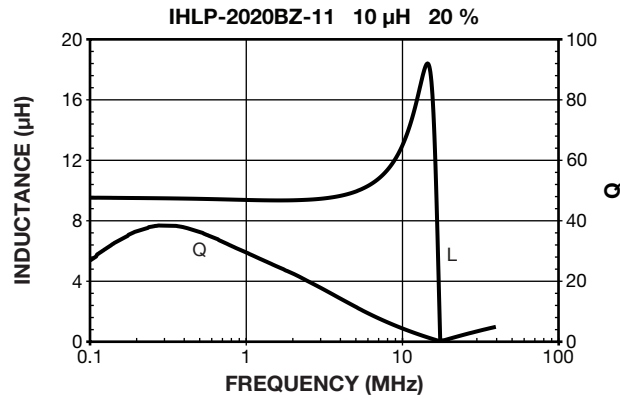
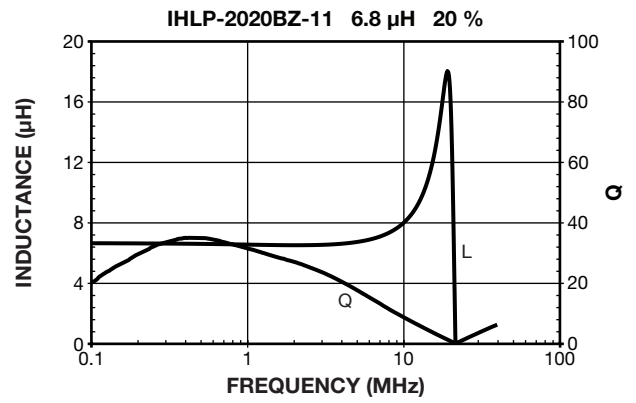
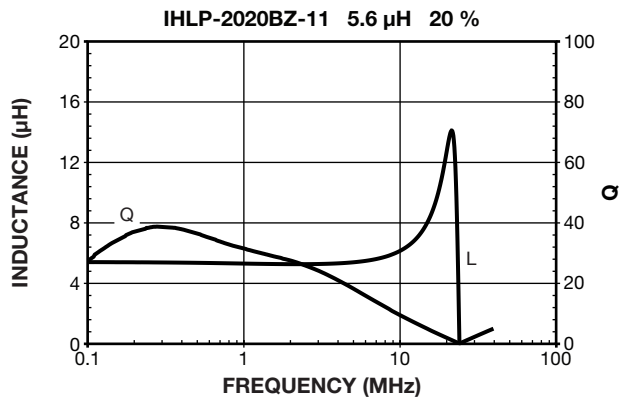

Low Profile, High Current IHLP® Inductors

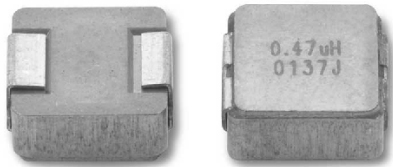

Manufactured under one or more of the following:
US Patents; 6,198,375/6,204,744/6,449,829/6,460,244.
 Several foreign patents, and other patents pending.

STANDARD ELECTRICAL SPECIFICATIONS				
L ₀ INDUCTANCE ± 20 % AT 100 kHz, 0.25 V, 0 A (µH)	DCR TYP. 25 °C (mΩ)	DCR MAX. 25 °C (mΩ)	HEAT RATING CURRENT DC TYP. (A) ⁽³⁾	SATURATION CURRENT DC TYP. (A) ⁽⁴⁾
0.10	3.00	3.16	23.0	27.0
0.22	4.30	4.52	15.5	21.0
0.33	5.30	5.56	13.7	19.0
0.47	6.70	7.04	12.2	16.0
0.68	8.53	8.96	10.2	13.5
0.82	11.3	11.9	9.3	13.0
1.0	13.1	13.7	9.2	12.0
1.5	19.7	20.7	7.2	11.0
2.2	27.8	29.2	5.8	10.0
3.3	52.1	54.7	5.0	8.5
4.7	73.8	77.5	3.5	8.2
5.6	103	108	3.0	4.1
10.0	152	158	2.5	4.0
15.0	252	265	1.9	2.5

Notes

- (1) All test data is referenced to 25 °C ambient
- (2) Operating temperature range - 55 °C to + 125 °C
- (3) DC current (A) that will cause an approximate ΔT of 40 °C
- (4) DC current (A) that will cause L₀ to drop approximately 20 %
- (5) The part temperature (ambient + temp. rise) should not exceed 125 °C under worst case operating conditions. Circuit design, component placement, PWB trace size and thickness, airflow and other cooling provisions all affect the part temperature. Part temperature should be verified in the end application.

FEATURES

- Shielded construction
- Frequency range up to 5.0 MHz
- Lowest DCR/µH, in this package size
- Handles high transient current spikes without saturation
- Ultra low buzz noise, due to composite construction
- Excellent temperature stability for inductance and saturation
- Compliant to RoHS Directive 2002/95/EC



RoHS
COMPLIANT
GREEN
[5-2009]**

APPLICATIONS

- PDA/notebook/desktop/server applications
- High current POL converters
- Low profile, high current power supplies
- Battery powered devices
- DC/DC converters in distributed power systems
- DC/DC converter for Field Programmable Gate Array (FPGA)

DIMENSIONS in inches [millimeters]

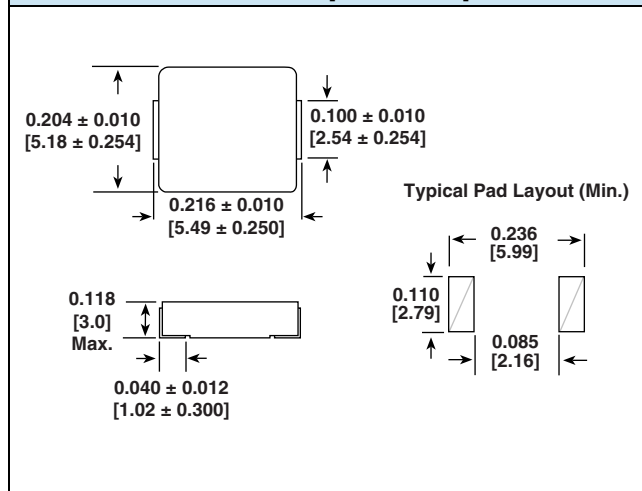

DESCRIPTION

IHLP-2020CZ-01	4.7 µH	± 20 %	ER	e3
MODEL	INDUCTANCE VALUE	INDUCTANCE TOLERANCE	PACKAGE CODE	JEDEC LEAD (Pb)-FREE STANDARD

GLOBAL PART NUMBER

I	H	L	P	2	0	2	0	C	Z	E	R	4	R	7	M	0	1
PRODUCT FAMILY				SIZE				PACKAGE CODE		INDUCTANCE VALUE			TOL.	SERIES			

** Please see document "Vishay Material Category Policy": www.vishay.com/doc?99902

PERFORMANCE GRAPHS

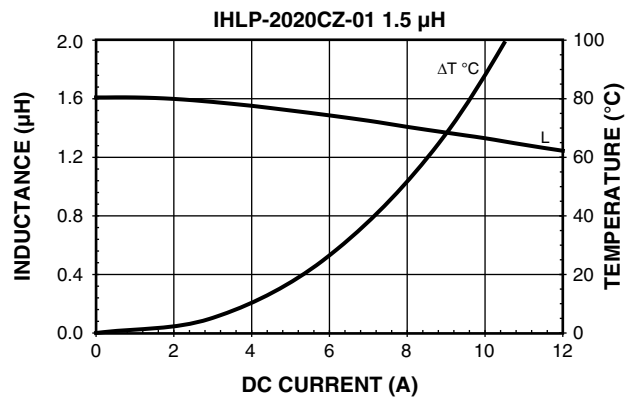
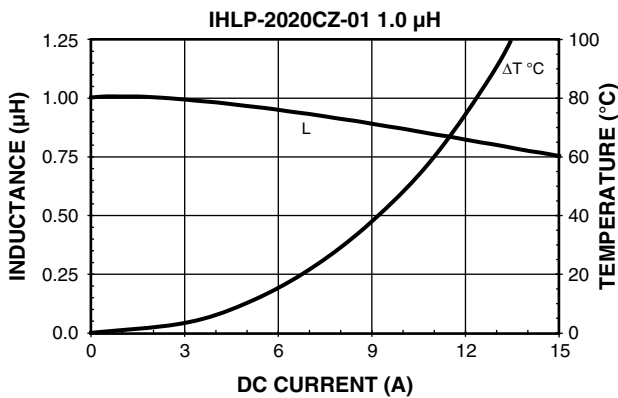
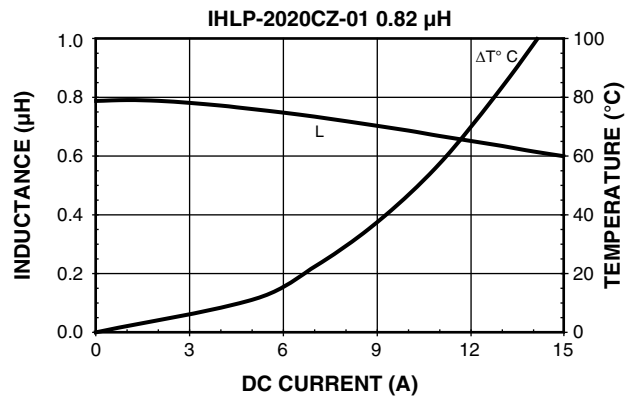
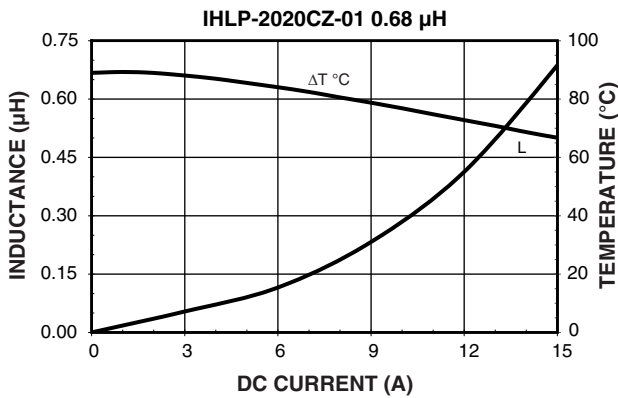
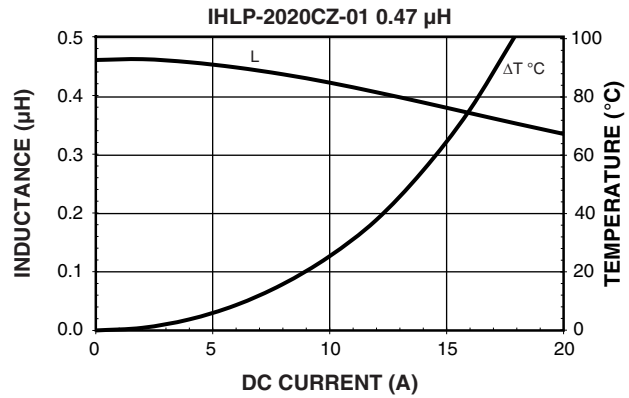
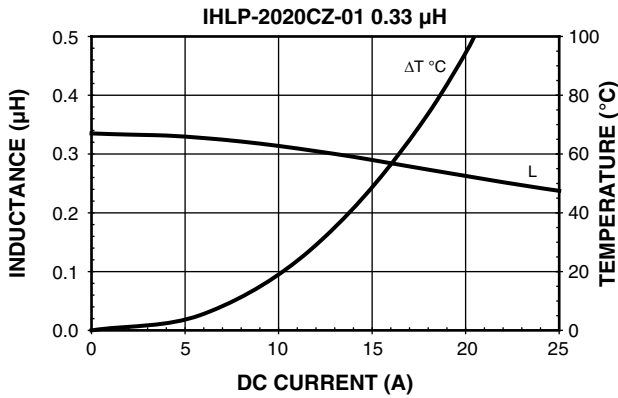
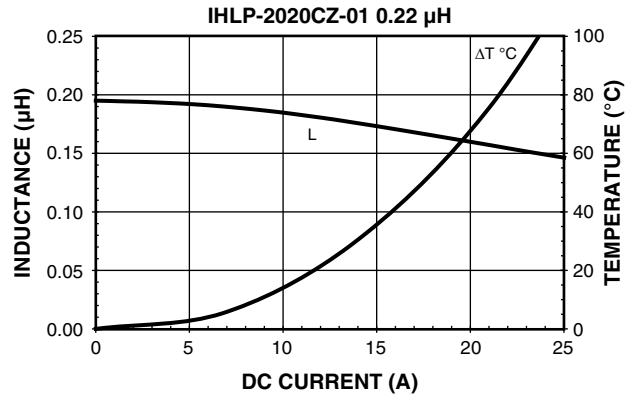
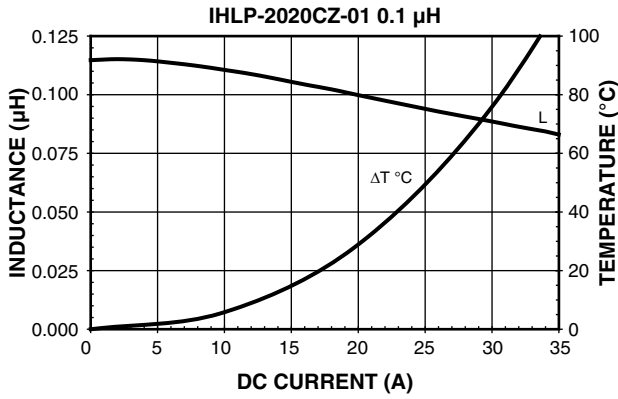



PERFORMANCE GRAPHS

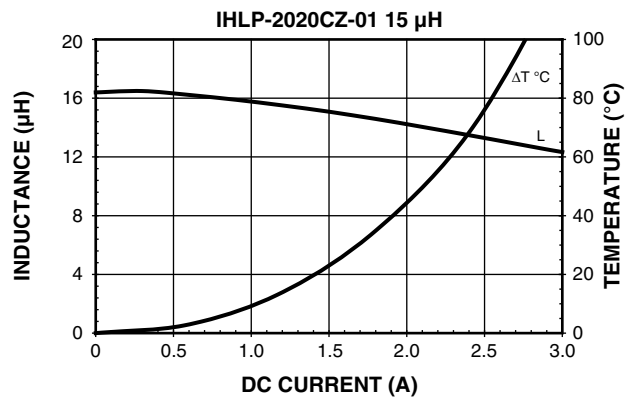
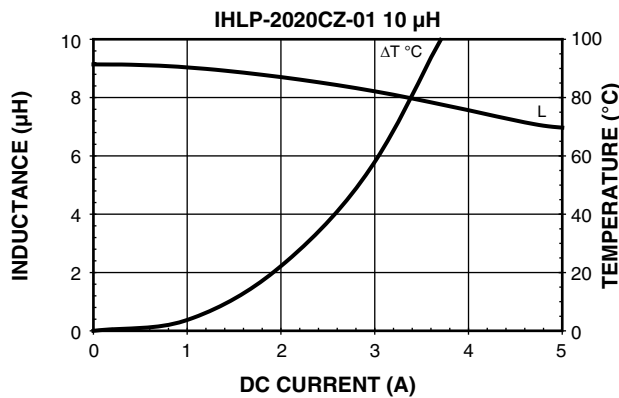
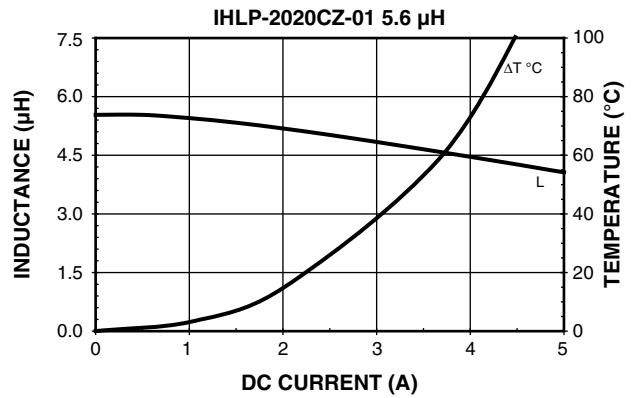
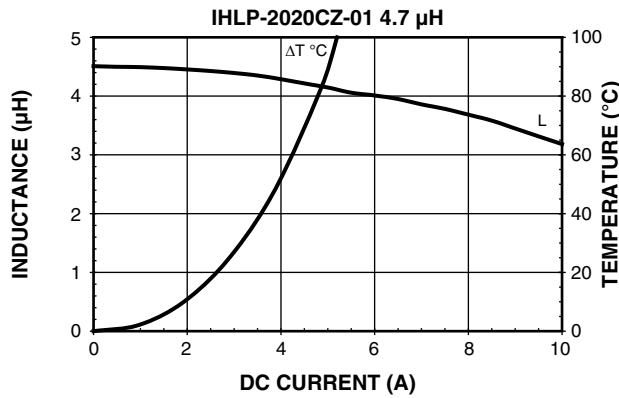
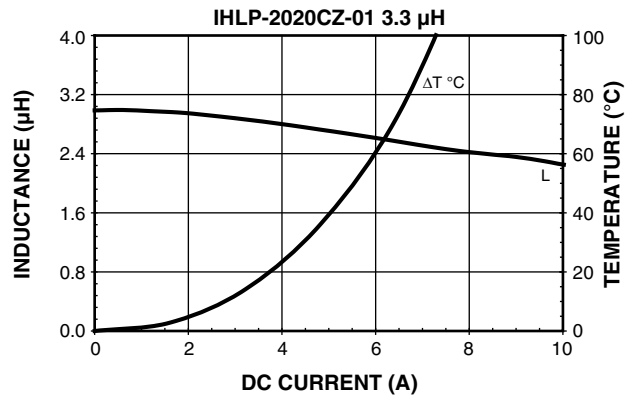
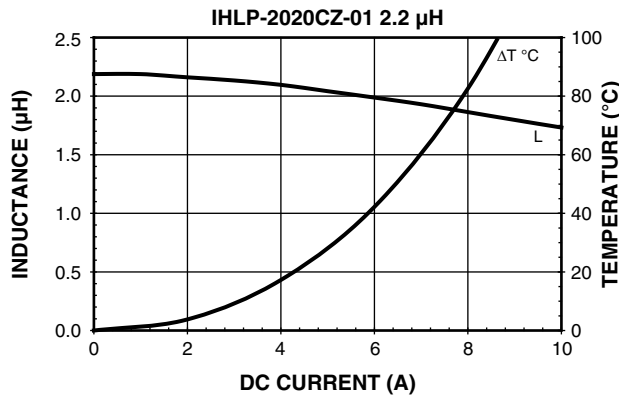

Low Profile, High Current IHLP® Inductors

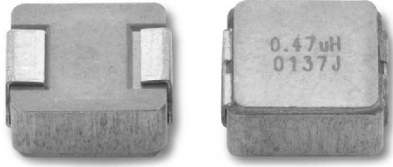

Manufactured under one or more of the following:
US Patents; 6,198,375/6,204,744/6,449,829/6,460,244.
 Several foreign patents, and other patents pending.

STANDARD ELECTRICAL SPECIFICATIONS				
L ₀ INDUCTANCE ± 20 % AT 100 kHz, 0.25 V, 0 A (µH)	DCR TYP. 25 °C (mΩ)	DCR MAX. 25 °C (mΩ)	HEAT RATING CURRENT DC TYP. (A) ⁽³⁾	SATURATION CURRENT DC TYP. (A) ⁽⁴⁾
0.10	2.6	2.9	21.00	25.00
0.22	3.5	3.9	21.00	14.50
0.33	4.5	5.0	16.50	9.00
0.47	5.4	6.0	14.00	9.00
1.0	10.0	11.0	10.00	6.50
1.5	17.1	18.5	7.50	7.00
2.2	22.5	25.0	6.75	5.50
3.3	36.4	40.4	5.50	7.00
4.7	54.0	60.0	4.50	5.20
5.6	63.0	70.6	4.25	3.50
10.0	122.1	131.9	2.75	2.25
22.0	260.0	270.0	1.90	1.70

Notes

- (1) All test data is referenced to 25 °C ambient
- (2) Operating temperature range - 55 °C to + 125 °C
- (3) DC current (A) that will cause an approximate ΔT of 40 °C
- (4) DC current (A) that will cause L₀ to drop approximately 20 %
- (5) The part temperature (ambient + temp. rise) should not exceed 125 °C under worst case operating conditions. Circuit design, component placement, PWB trace size and thickness, airflow and other cooling provisions all affect the part temperature. Part temperature should be verified in the end application.

FEATURES

- Shielded construction
- Frequency range up to 1.0 MHz
- Lowest DCR/µH, in this package size
- Handles high transient current spikes without saturation
- Ultra low buzz noise, due to composite construction
- Excellent temperature stability for inductance and saturation
- Compliant to RoHS Directive 2002/95/EC
- Halogen-free according to IEC 61249-2-21 definition



RoHS
 COMPLIANT
 HALOGEN
FREE

APPLICATIONS

- PDA/notebook/desktop/server applications
- High current POL converters
- Low profile, high current power supplies
- Battery powered devices
- DC/DC converters in distributed power systems
- DC/DC converter for Field Programmable Gate Array (FPGA)

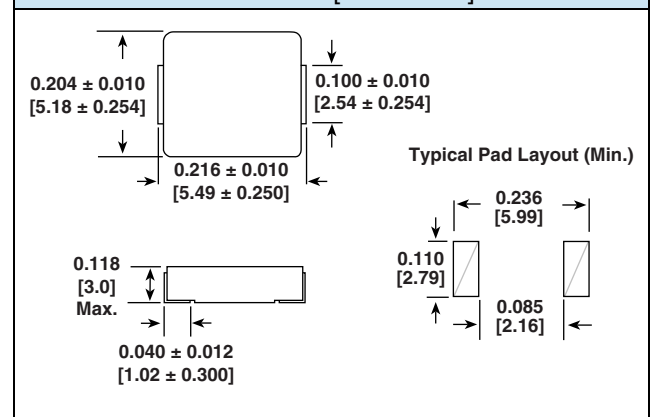
DIMENSIONS in inches [millimeters]

DESCRIPTION

IHLP-2020CZ-11	4.7 µH	± 20 %	ER	e3
MODEL	INDUCTANCE VALUE	INDUCTANCE TOLERANCE	PACKAGE CODE	JEDEC LEAD (Pb)-FREE STANDARD

GLOBAL PART NUMBER

I	H	L	P	2	0	2	0	C	Z	E	R	4	R	7	M	1	1
PRODUCT FAMILY				SIZE				PACKAGE CODE		INDUCTANCE VALUE		TOL.	SERIES				

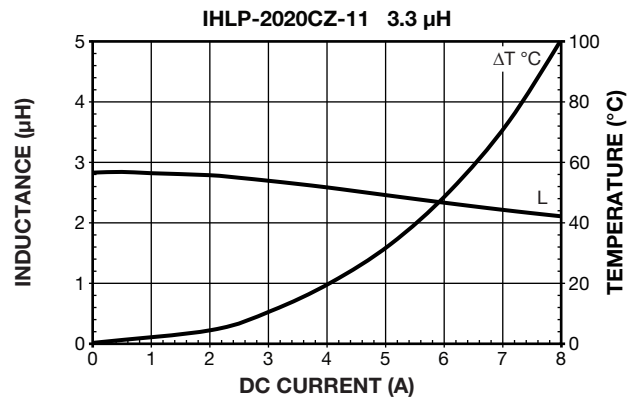
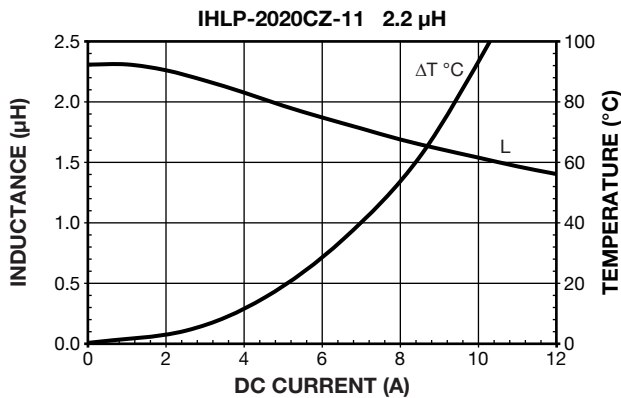
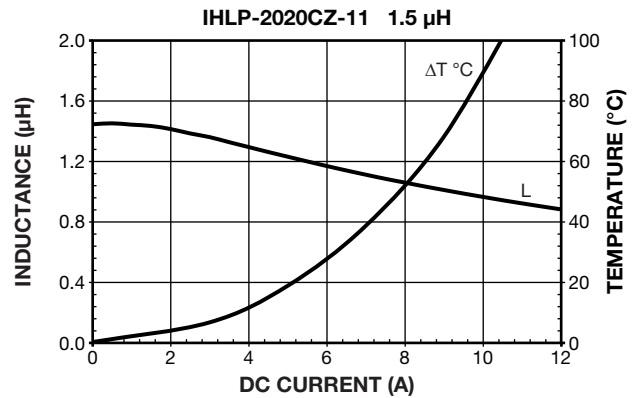
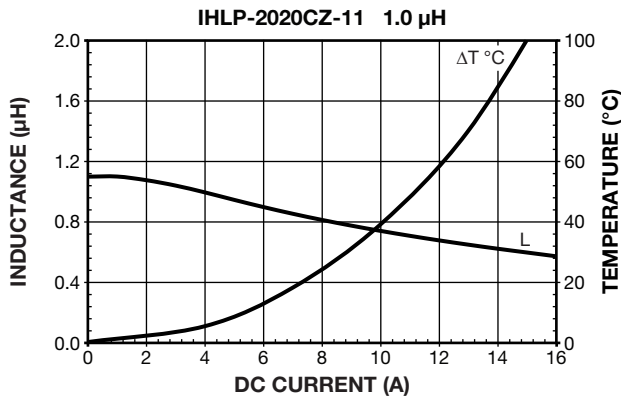
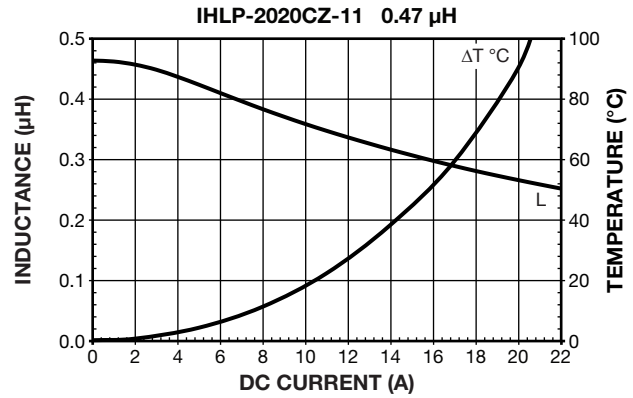
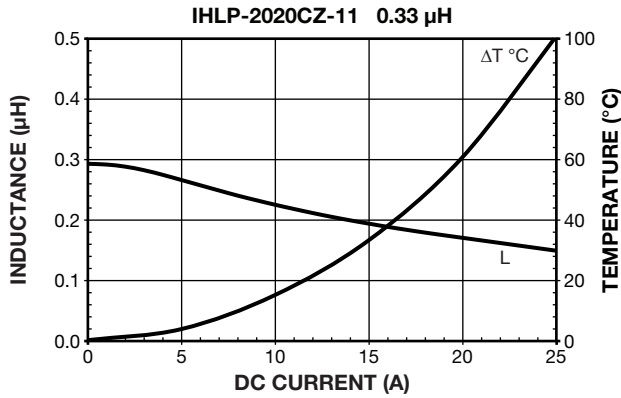
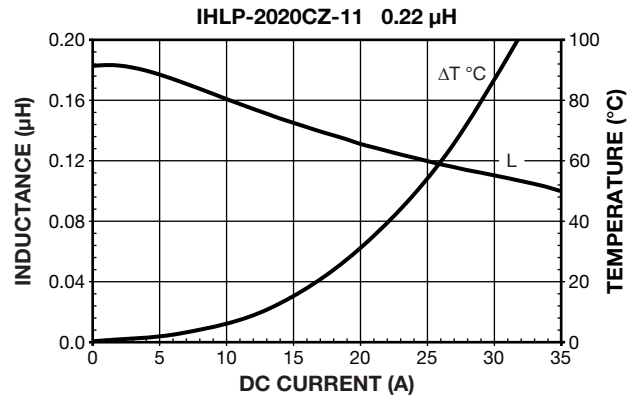
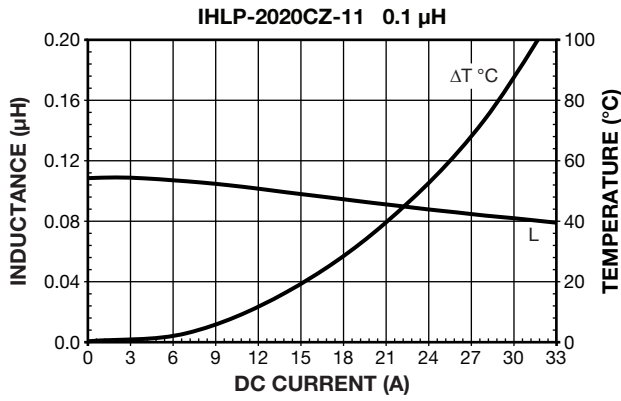
PERFORMANCE GRAPHS





PERFORMANCE GRAPHS

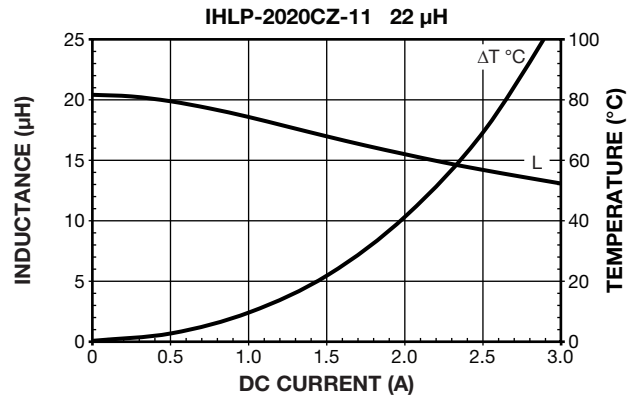
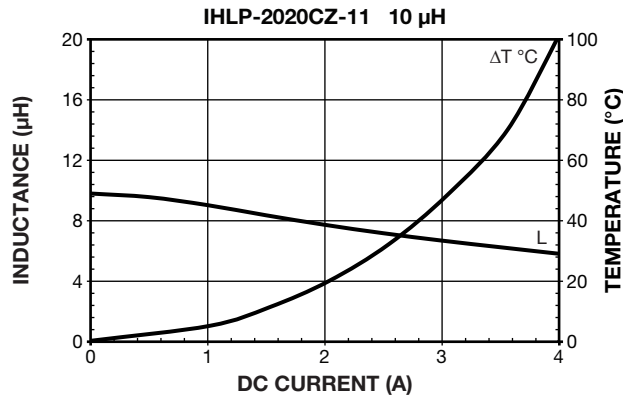
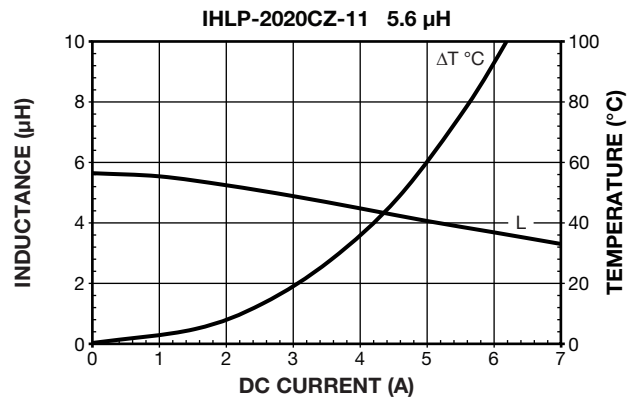
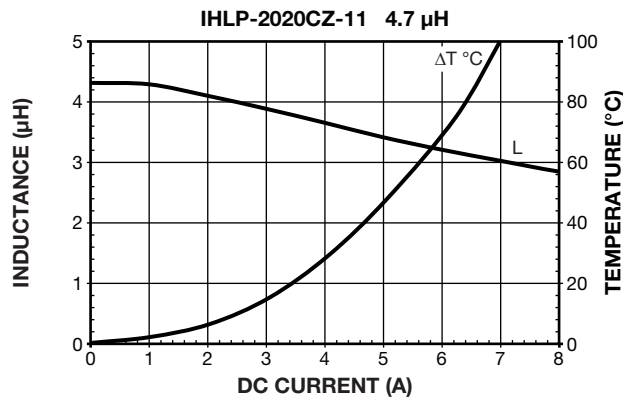

PERFORMANCE GRAPHS: INDUCTANCE AND Q VS. FREQUENCY

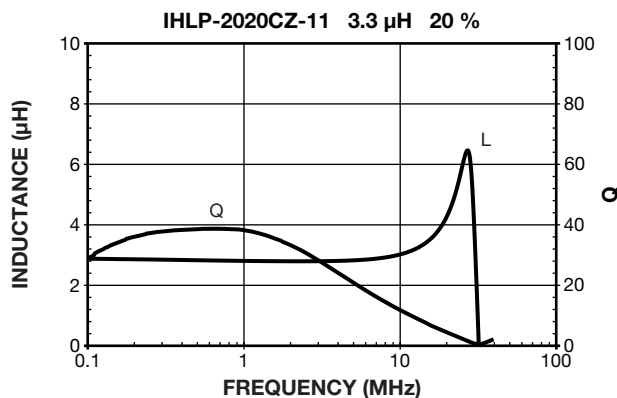
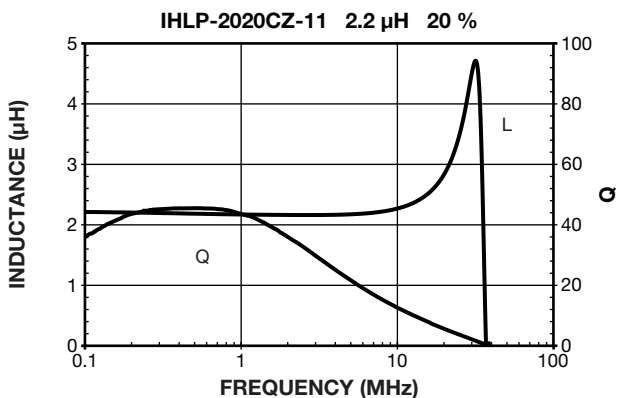
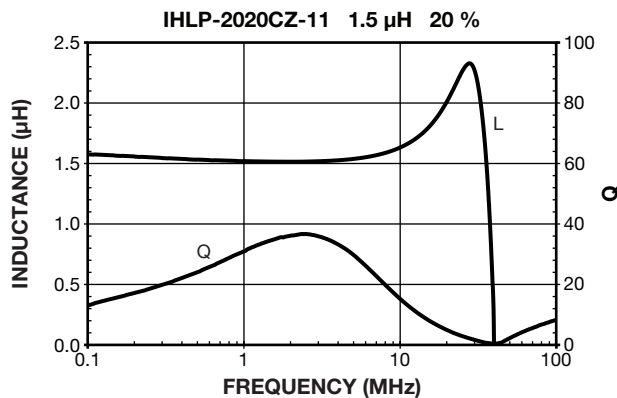
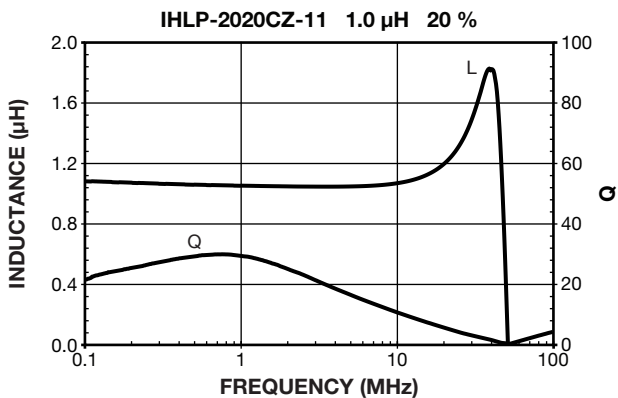
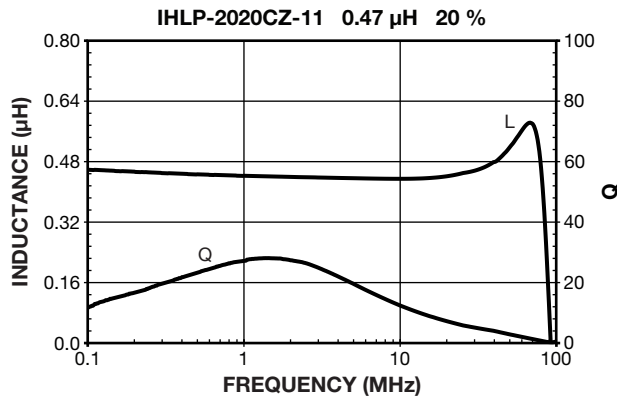
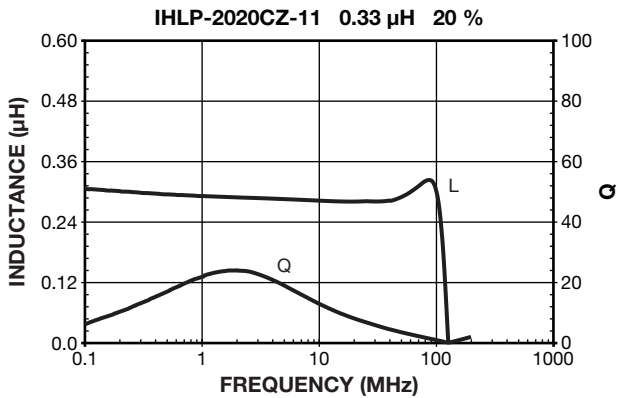
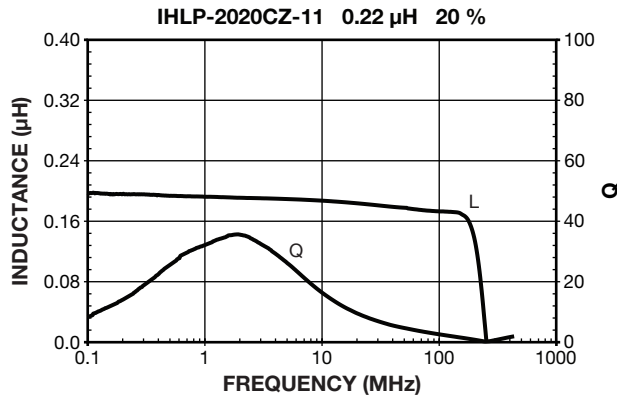
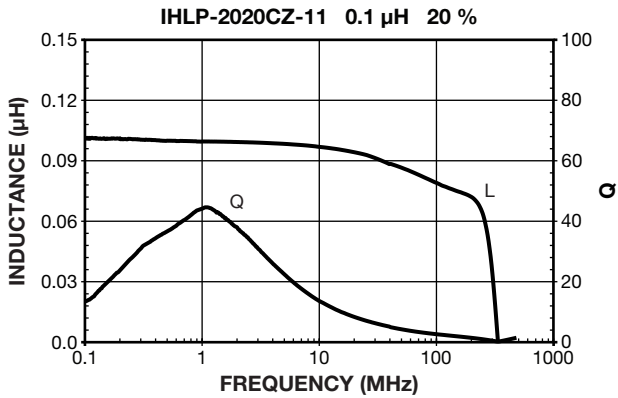



PERFORMANCE GRAPHS: INDUCTANCE AND Q VS. FREQUENCY

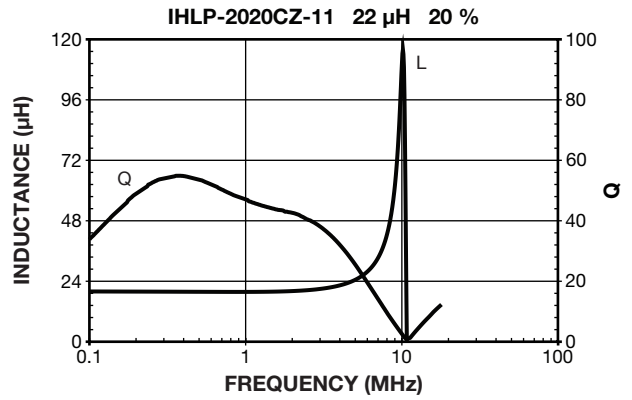
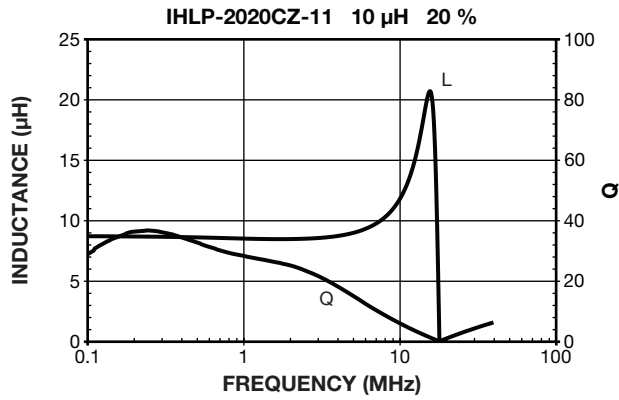
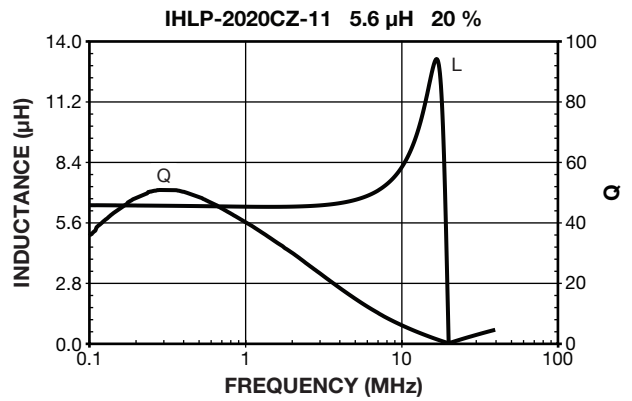
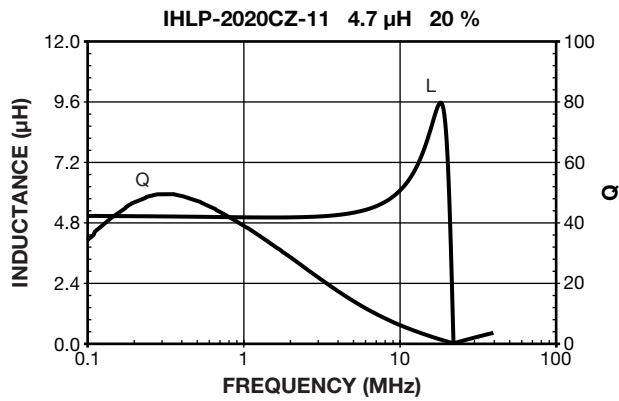

Low Profile, High Current IHLP® Inductors

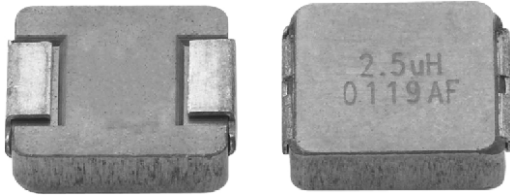

Manufactured under one or more of the following:
US Patents; 6,198,375/6,204,744/6,449,829/6,460,244.
 Several foreign patents, and other patents pending.

STANDARD ELECTRICAL SPECIFICATIONS				
L ₀ INDUCTANCE ± 20 % AT 100 kHz, 0.25 V, 0 A (μH)	DCR TYP. 25 °C (mΩ)	DCR MAX. 25 °C (mΩ)	HEAT RATING CURRENT DC TYP. (A) ⁽³⁾	SATURATION CURRENT DC TYP. (A) ⁽⁴⁾
0.1	3.0	3.5	18	40
0.15	4.7	5.2	15	38
0.22	5.3	5.7	14	26
0.33	6.6	7.0	12	18
0.47	8.4	9.3	11	18
0.68	12.7	13.9	9	17
0.82	13.8	15.9	8	17
1.0	17.5	18.3	7	14
1.5	32.6	34.0	4	11.5
2.2	40.3	46.0	3.75	13
2.5	49.9	52.4	3.5	10.4
3.3	56.2	60.1	3.25	10
4.7	76.6	78.0	3	8

Notes

- (1) All test data is referenced to 25 °C ambient
- (2) Operating temperature range - 55 °C to + 125 °C
- (3) DC current (A) that will cause an approximate ΔT of 40 °C
- (4) DC current (A) that will cause L₀ to drop approximately 20 %
- (5) The part temperature (ambient + temp. rise) should not exceed 125 °C under worst case operating conditions. Circuit design, component placement, PWB trace size and thickness, airflow and other cooling provisions all affect the part temperature. Part temperature should be verified in the end application.

FEATURES

- Lowest height (1.8 mm) in this package footprint
- Shielded construction
- Frequency range up to 5.0 MHz
- Lowest DCR/μH, in this package size
- Handles high transient current spikes without saturation
- Ultra low buzz noise, due to composite construction
- Compliant to RoHS Directive 2002/95/EC



RoHS
 COMPLIANT
GREEN
 (5-2008)**

APPLICATIONS

- PDA/notebook/desktop/server applications
- High current POL converters
- Low profile, high current power supplies
- Battery powered devices
- DC/DC converters in distributed power systems
- DC/DC converter for Field Programmable Gate Array (FPGA)

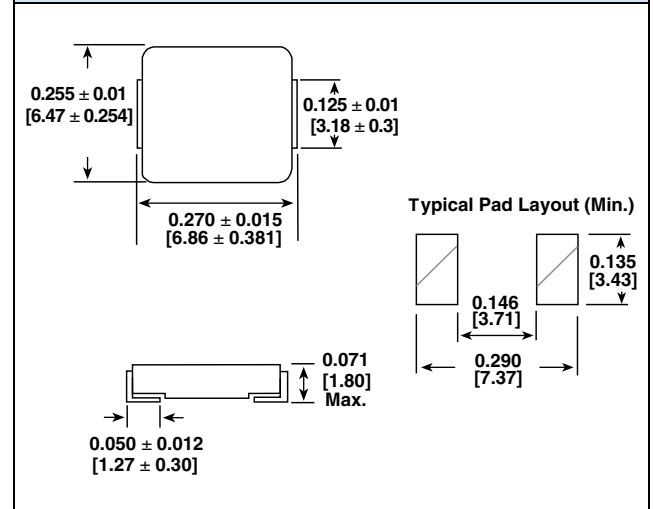
DIMENSIONS in inches [millimeters]

DESCRIPTION

IHLP-2525AH-01	1.0 μH	± 20 %	ER	e3
MODEL	INDUCTANCE VALUE	INDUCTANCE TOLERANCE	PACKAGE CODE	JEDEC LEAD (Pb)-FREE STANDARD

GLOBAL PART NUMBER

I	H	L	P	2	5	2	5	A	H	E	R	1	R	0	M	0	1
PRODUCT FAMILY				SIZE				PACKAGE CODE		INDUCTANCE VALUE			TOL.		SERIES		

** Please see document "Vishay Material Category Policy": www.vishay.com/doc?99902

PERFORMANCE GRAPHS

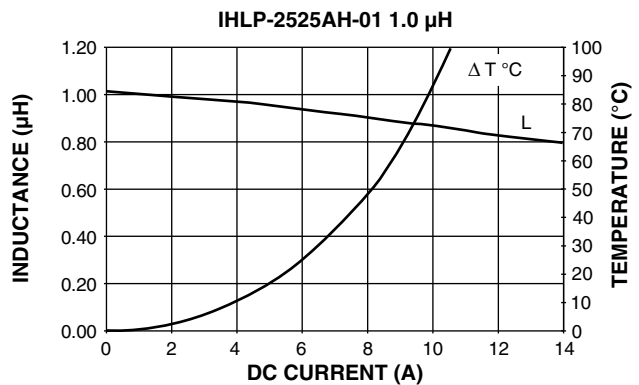
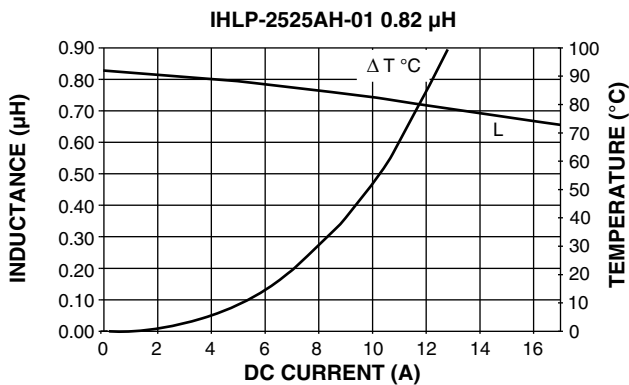
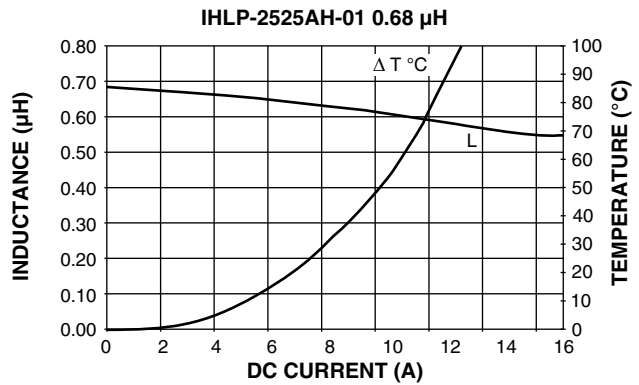
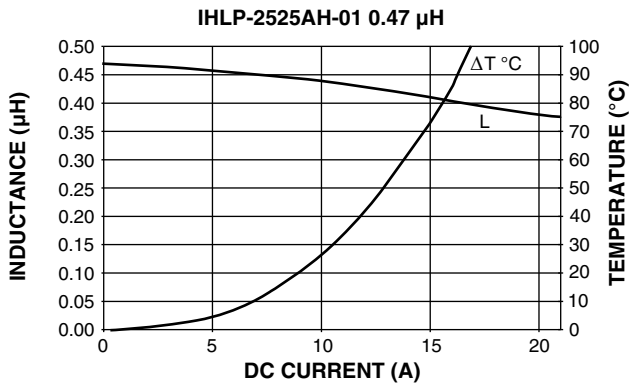
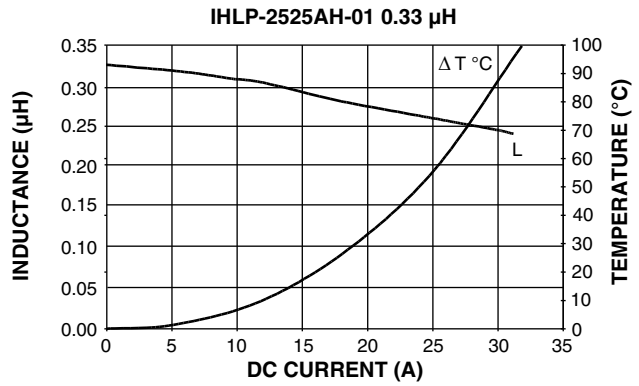
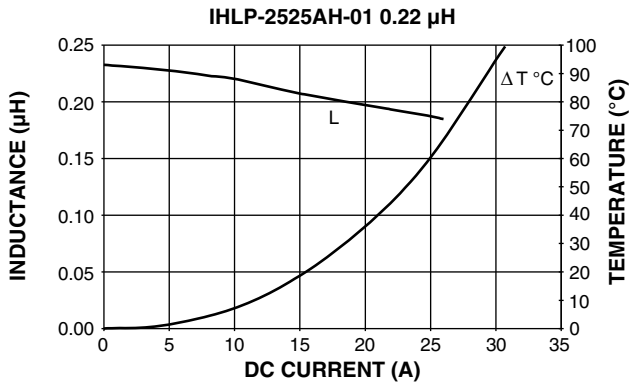
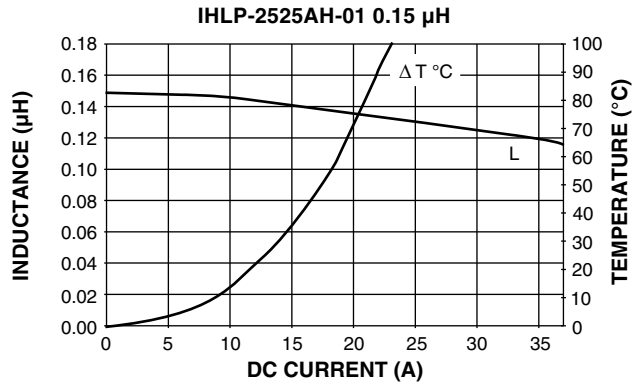
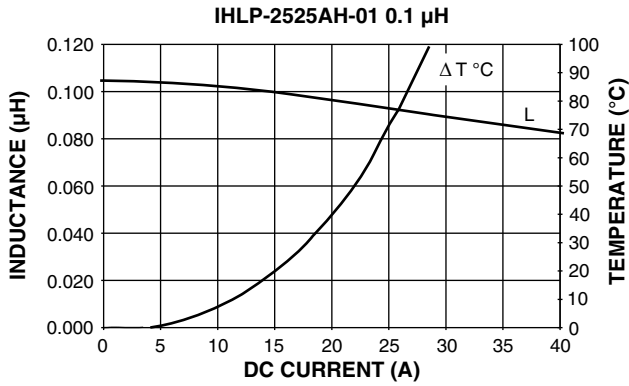



PERFORMANCE GRAPHS

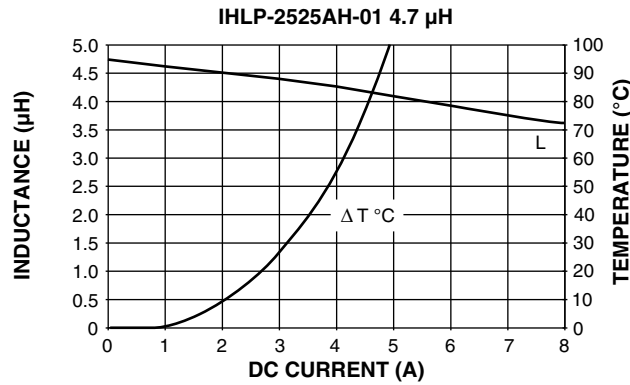
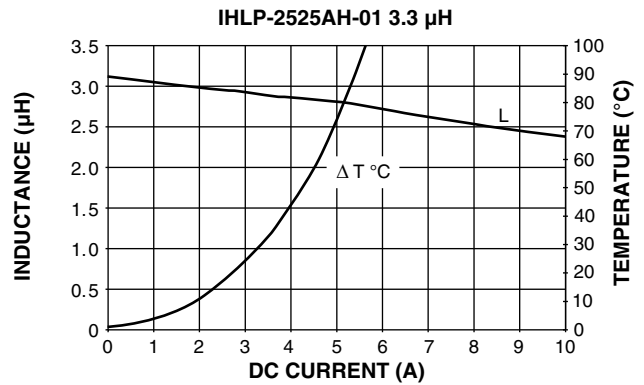
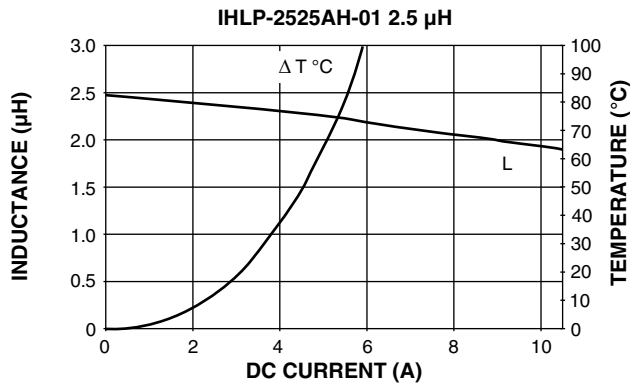
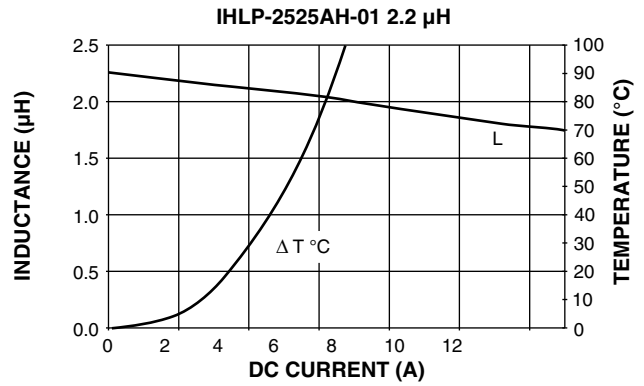
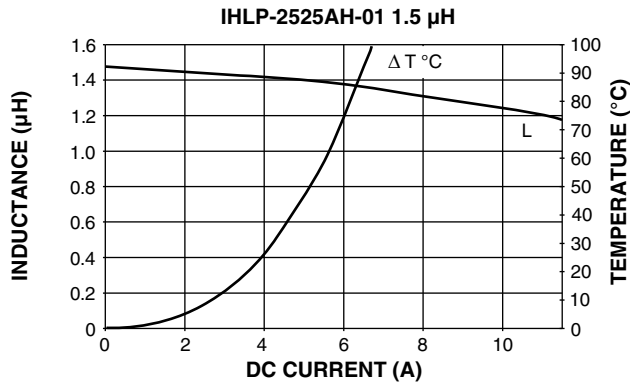

Low Profile, High Current IHLP® Inductors

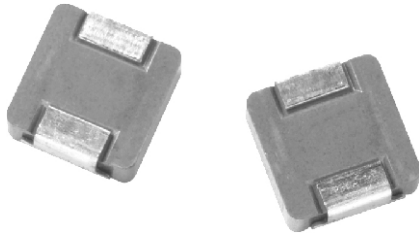

Manufactured under one or more of the following:
US Patents; 6,198,375/6,204,744/6,449,829/6,460,244.
 Several foreign patents, and other patents pending.

STANDARD ELECTRICAL SPECIFICATIONS				
L_0 INDUCTANCE ± 20 % AT 100 kHz, 0.25 V, 0 A (μ H)	DCR TYP. 25 °C (m Ω)	DCR MAX. 25 °C (m Ω)	HEAT RATING CURRENT DC TYP. (A) ⁽³⁾	SATURATION CURRENT DC TYP. (A) ⁽⁴⁾
0.1	1.5	1.7	30	50
0.22	2.9	3.2	21	34
0.33	3.7	4.1	18	22
0.47	6.0	6.5	13.5	21
0.68	8.7	9.4	11	18
0.82	10.6	11.8	10	17
1.0	13.1	14.2	9.0	16
1.5	18.5	21.2	7.5	15
2.2	28.0	34.0	6.5	14
3.3	36.5	51.6	5.0	13
4.7	45.2	63.0	4.5	10
6.8	72.5	95.0	3.5	9
8.2	84.2	106	3.0	8
10	115.6	129	2.5	7

Notes

- (1) All test data is referenced to 25 °C ambient
- (2) Operating temperature range - 55 °C to + 125 °C
- (3) DC current (A) that will cause an approximate ΔT of 40 °C
- (4) DC current (A) that will cause L_0 to drop approximately 20 %
- (5) The part temperature (ambient + temp. rise) should not exceed 125 °C under worst case operating conditions. Circuit design, component placement, PWB trace size and thickness, airflow and other cooling provisions all affect the part temperature. Part temperature should be verified in the end application.

FEATURES

- Lowest height (2.4 mm) in this package footprint
- Shielded construction
- Frequency range up to 5.0 MHz
- Lowest DCR/ μ H, in this package size
- Handles high transient current spikes without saturation
- Ultra low buzz noise, due to composite construction
- Compliant to RoHS Directive 2002/95/EC



RoHS
 COMPLIANT
GREEN
 (5-2008)**

APPLICATIONS

- PDA/notebook/desktop/server applications
- High current POL converters
- Low profile, high current power supplies
- Battery powered devices
- DC/DC converters in distributed power systems
- DC/DC converter for Field Programmable Gate Array (FPGA)

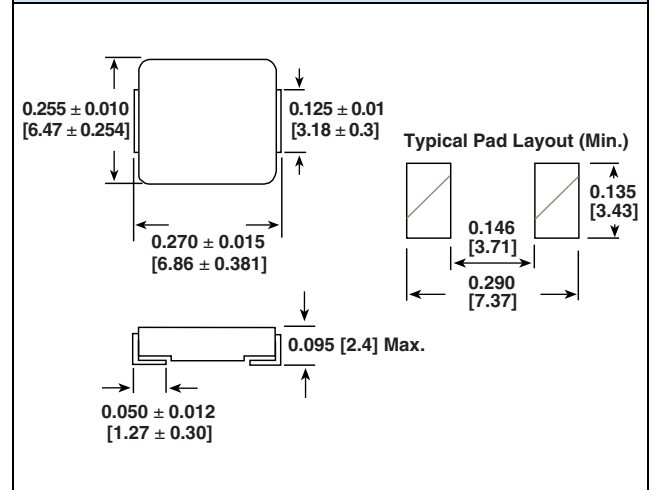
DIMENSIONS in inches [millimeters]

DESCRIPTION

IHLP-2525BD-01	1.0 μH	± 20 %	ER	e3
MODEL	INDUCTANCE VALUE	INDUCTANCE TOLERANCE	PACKAGE CODE	JEDEC LEAD (Pb)-FREE STANDARD

GLOBAL PART NUMBER

I	H	L	P	2	5	2	5	B	D	E	R	1	R	0	M	0	1
PRODUCT FAMILY				SIZE					PACKAGE CODE		INDUCTANCE VALUE			TOL.	SERIES		

** Please see document "Vishay Material Category Policy": www.vishay.com/doc?99902

PERFORMANCE GRAPHS

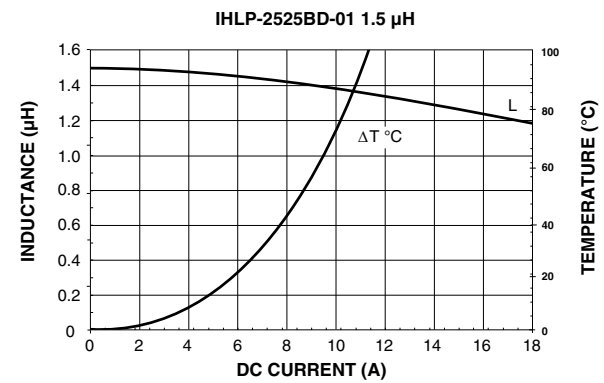
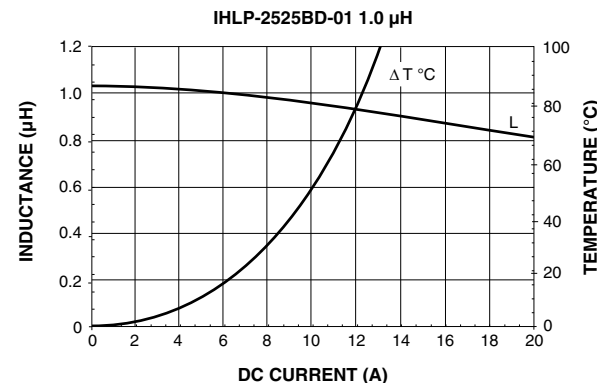
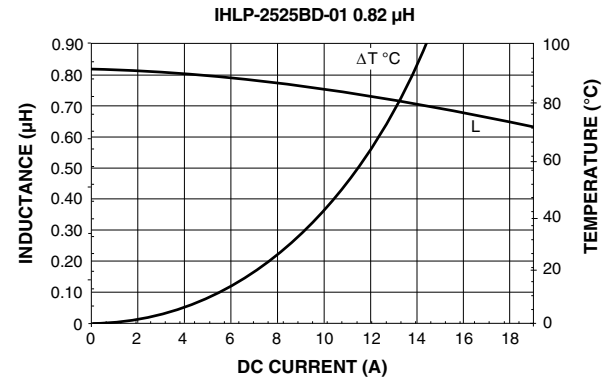
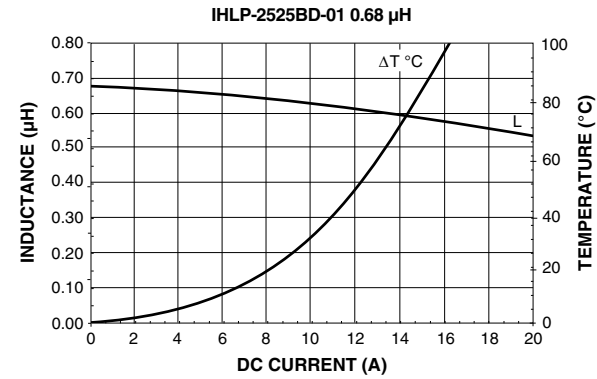
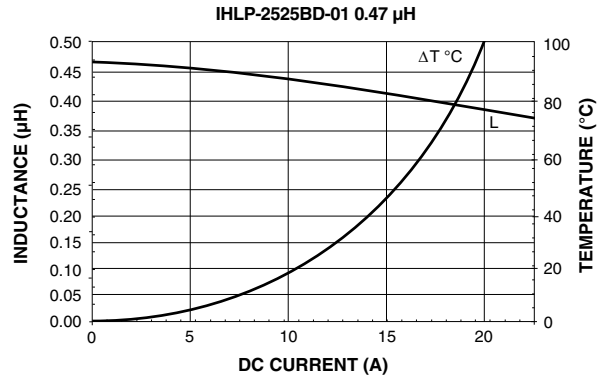
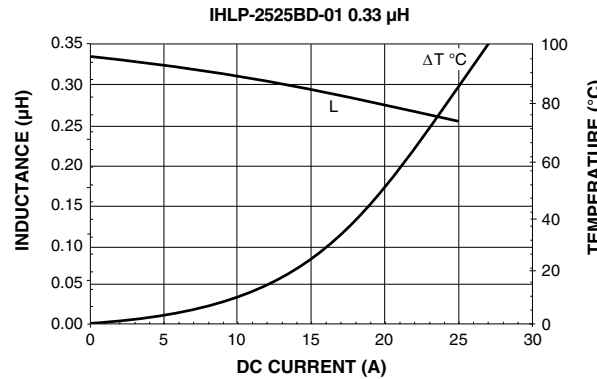
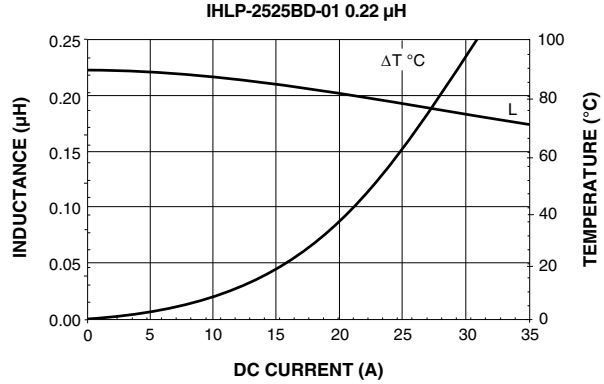
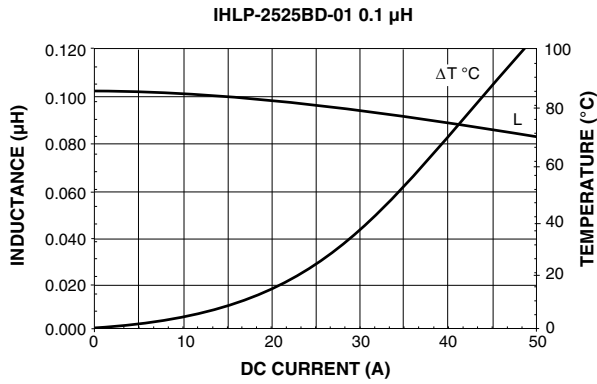



PERFORMANCE GRAPHS

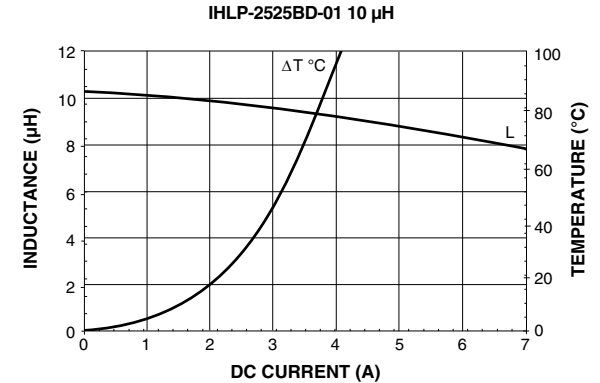
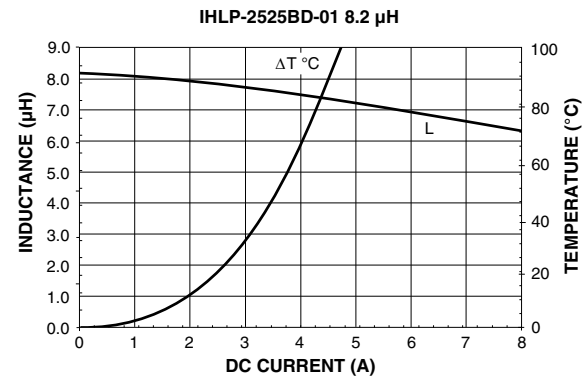
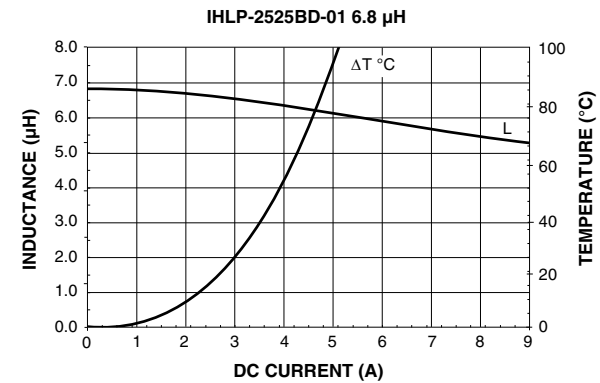
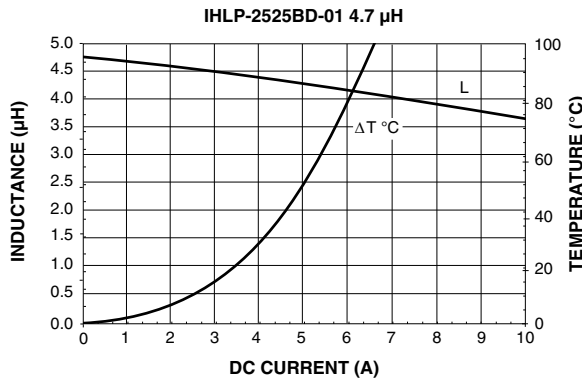
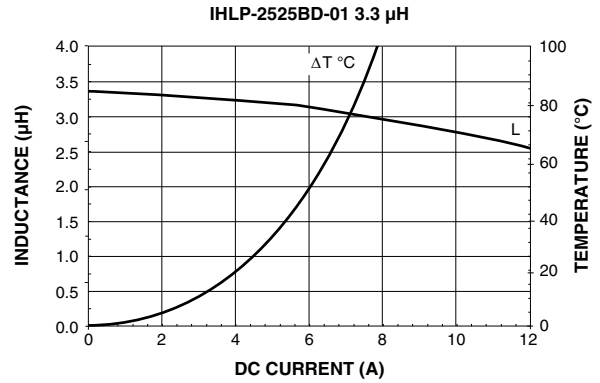
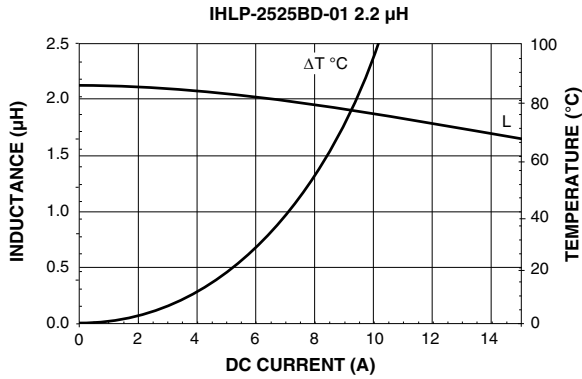

Low Profile, High Current IHLP® Inductors

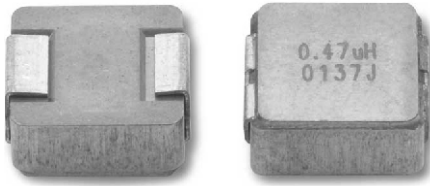

Manufactured under one or more of the following:
US Patents; 6,198,375/6,204,744/6,449,829/6,460,244.
 Several foreign patents, and other patents pending.

STANDARD ELECTRICAL SPECIFICATIONS

L_0 INDUCTANCE ± 20 % AT 100 kHz, 0.25 V, 0 A (µH)	DCR TYP. 25 °C (mΩ)	DCR MAX. 25 °C (mΩ)	HEAT RATING CURRENT DC TYP. (A) ⁽³⁾	SATURATION CURRENT DC TYP. (A) ⁽⁴⁾
0.10	1.5	1.7	32.5	60
0.15	1.9	2.5	26	52
0.20	2.4	3.0	24	41
0.22	2.5	2.8	23	40
0.33	3.5	3.9	20	30
0.47	4	4.2	17.5	26
0.68	5	5.5	15.5	25
0.82	6.7	8	13	24
1.0	9	10	11	22
1.5	14	15	9	18
2.2	18	20	8	14
3.3	28	30	6	13.5
4.7	37	40	5.5	10
6.8	54	60	4.5	8
8.2	64	68	4	7.5
10	102	105	3	7.0

Notes

- (1) All test data is referenced to 25 °C ambient
- (2) Operating temperature range - 55 °C to + 125 °C
- (3) DC current (A) that will cause an approximate ΔT of 40 °C
- (4) DC current (A) that will cause L_0 to drop approximately 20 %
- (5) The part temperature (ambient + temp. rise) should not exceed 125 °C under worst case operating conditions. Circuit design, component placement, PWB trace size and thickness, airflow and other cooling provisions all affect the part temperature. Part temperature should be verified in the end application.

FEATURES

- Lowest height (3.0 mm) in this package footprint
- Shielded construction
- Frequency range up to 5.0 MHz
- Lowest DCR/µH, in this package size
- Handles high transient current spikes without saturation
- Ultra low buzz noise, due to composite construction
- Compliant to RoHS Directive 2002/95/EC



RoHS
COMPLIANT
GREEN
(5-2008)**

APPLICATIONS

- PDA/notebook/desktop/server applications
- High current POL converters
- Low profile, high current power supplies
- Battery powered devices
- DC/DC converters in distributed power systems
- DC/DC converter for Field Programmable Gate Array (FPGA)

DIMENSIONS in inches [millimeters]

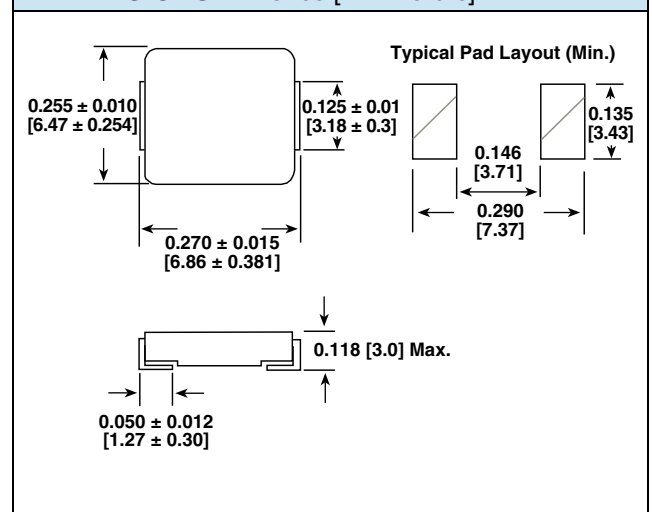

DESCRIPTION

IHLP-2525CZ-01	1.0 µH	± 20 %	ER	e3
MODEL	INDUCTANCE VALUE	INDUCTANCE TOLERANCE	PACKAGE CODE	JEDEC LEAD (Pb)-FREE STANDARD

GLOBAL PART NUMBER

I	H	L	P	2	5	2	5	C	Z	E	R	1	R	0	M	0	1
PRODUCT FAMILY				SIZE				PACKAGE CODE		INDUCTANCE VALUE		TOL.	SERIES				

** Please see document "Vishay Material Category Policy": www.vishay.com/doc?99902

PERFORMANCE GRAPHS

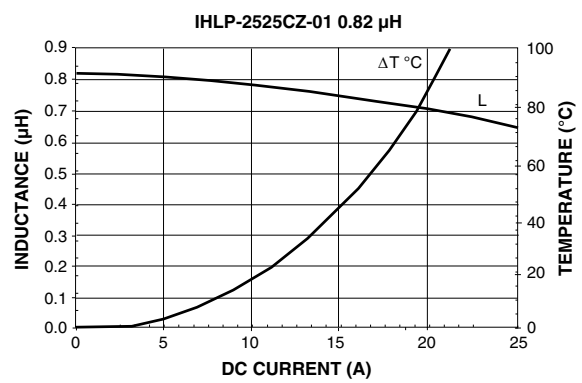
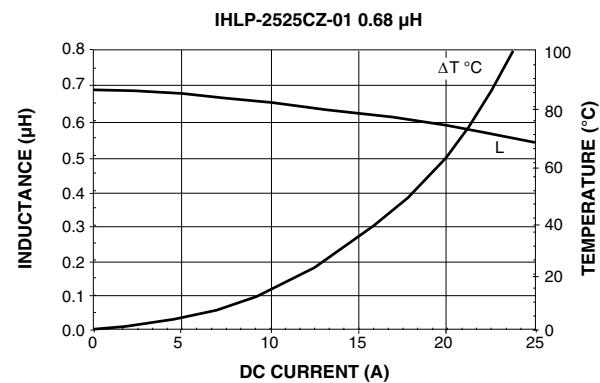
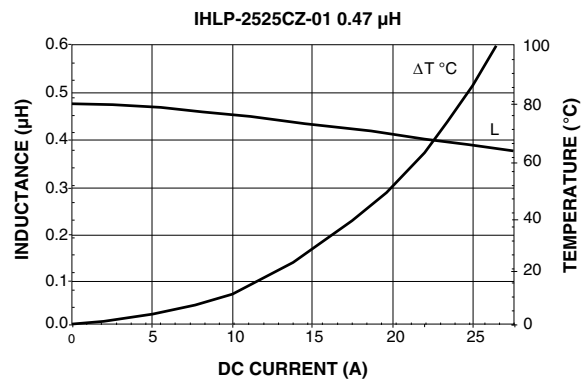
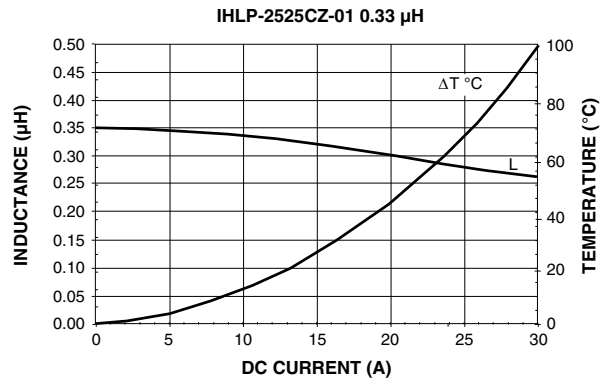
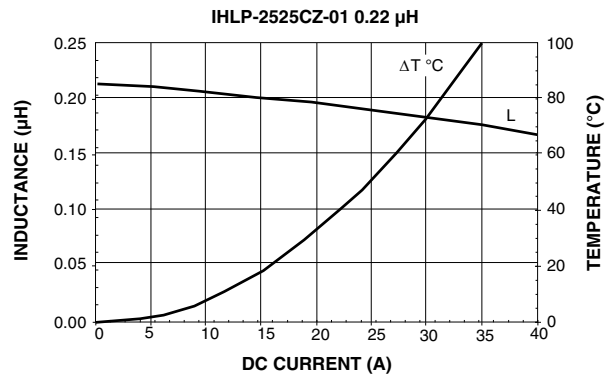
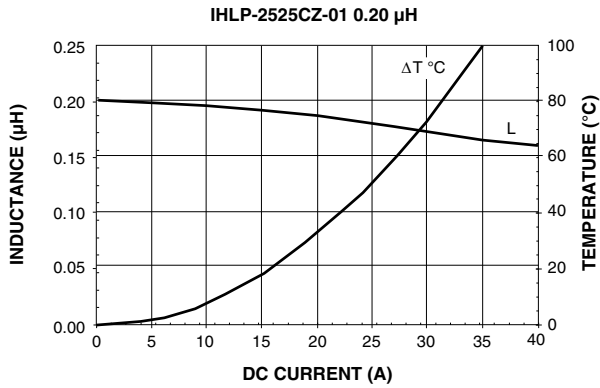
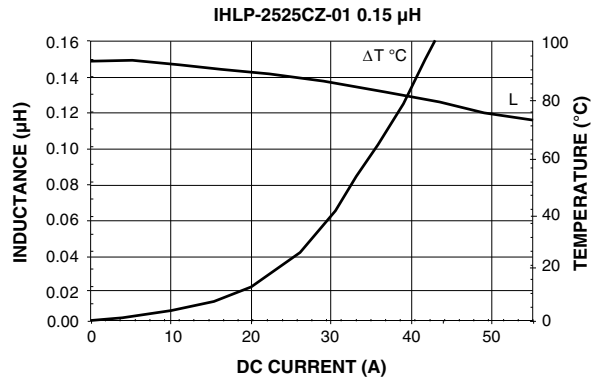
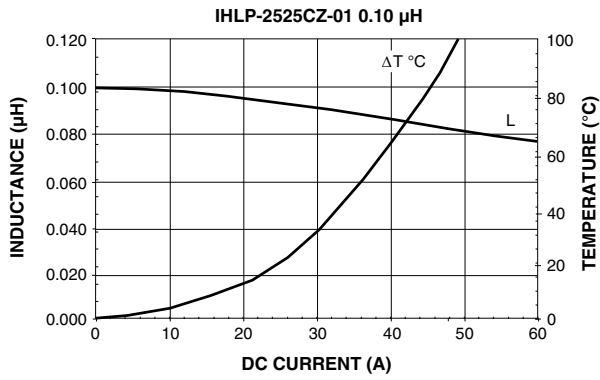



PERFORMANCE GRAPHS

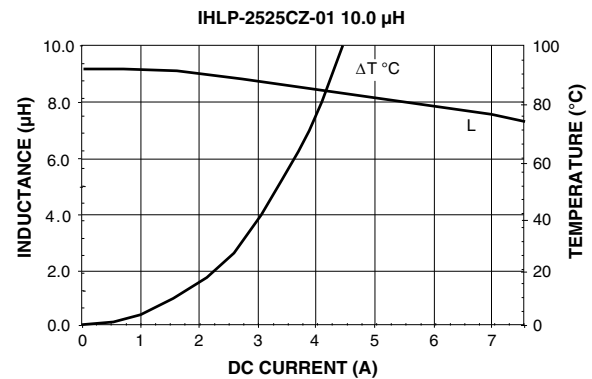
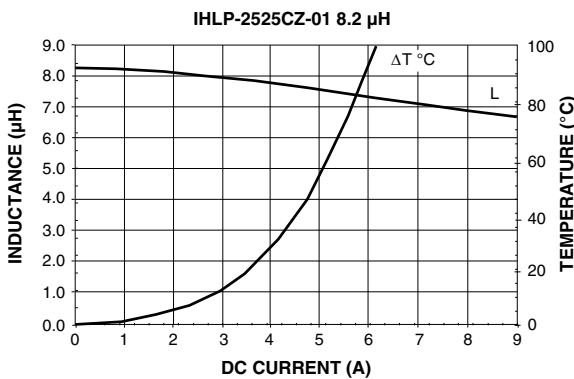
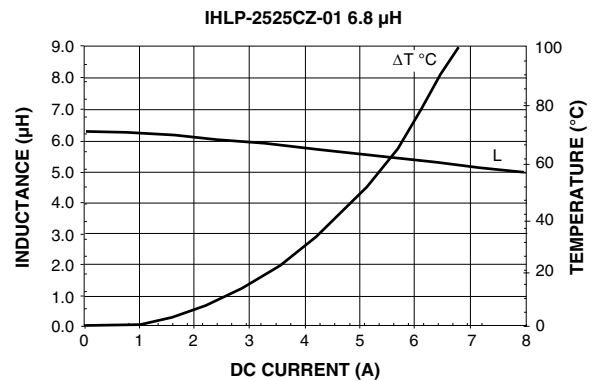
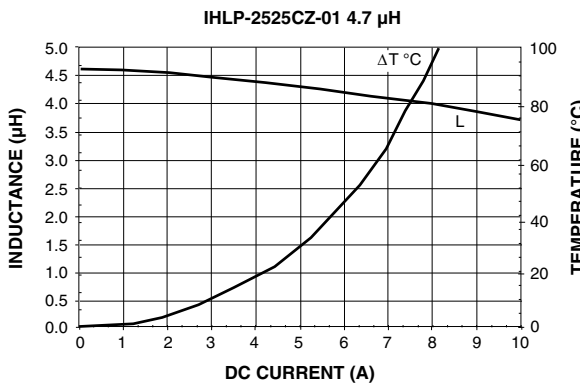
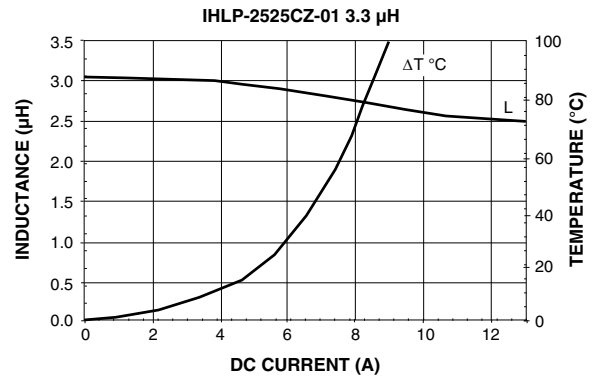
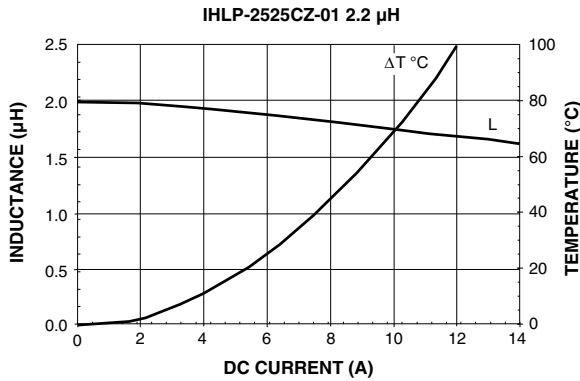
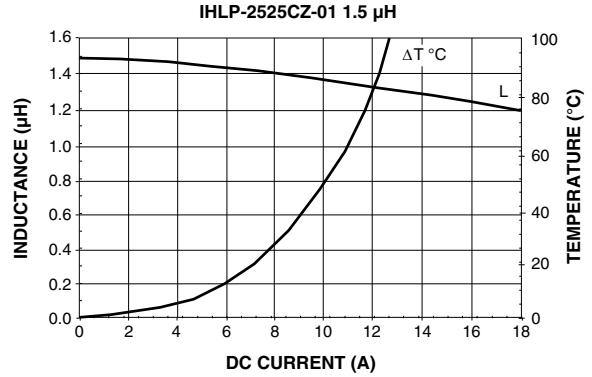
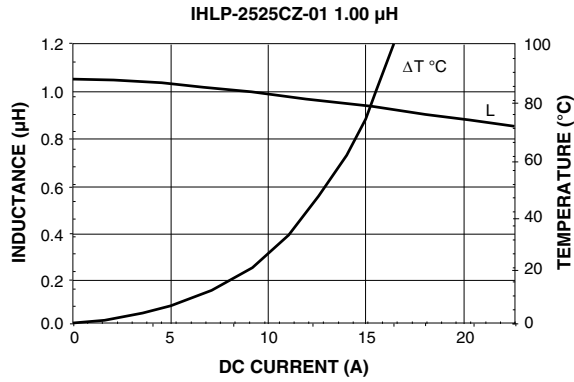

Low Profile, High Current IHLP® Inductors

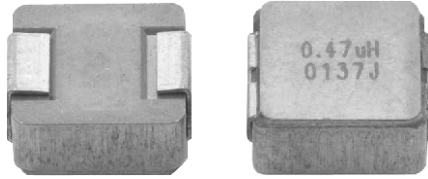

Manufactured under one or more of the following:
US Patents; 6,198,375/6,204,744/6,449,829/6,460,244.
 Several foreign patents, and other patents pending.

STANDARD ELECTRICAL SPECIFICATIONS				
L_0 INDUCTANCE ± 20 % AT 100 kHz, 0.25 V, 0 A (µH)	DCR TYP. 25 °C (mΩ)	DCR MAX. 25 °C (mΩ)	HEAT RATING CURRENT DC TYP. (A) ⁽³⁾	SATURATION CURRENT DC TYP. (A) ⁽⁴⁾
1.0	7.6	8.0	12.5	9.5
2.2	15.7	16.5	9.0	7.0
3.3	24.8	26.0	7.0	6.5
4.7	31.8	33.4	6.0	4.0
6.8	44.6	46.8	5.5	4.0
8.2	52.3	54.9	5.0	4.0
10	67.8	71.2	4.0	3.5
22	128.9	135.0	2.9	2.5

Notes

- (1) All test data is referenced to 25 °C ambient
- (2) Operating temperature range - 55 °C to + 125 °C
- (3) DC current (A) that will cause an approximate ΔT of 40 °C
- (4) DC current (A) that will cause L_0 to drop approximately 20 %
- (5) The part temperature (ambient + temp. rise) should not exceed 125 °C under worst case operating conditions. Circuit design, component placement, PWB trace size and thickness, airflow and other cooling provisions all affect the part temperature. Part temperature should be verified in the end application.

FEATURES

- Shielded construction
- Frequency range up to 1.0 MHz
- Lowest DCR/µH, in this package size
- Powered iron composition provides soft saturation
- Handles high transient current spikes without hard saturation
- Ultra low buzz noise, due to composite construction
- Compliant to RoHS Directive 2002/95/EC
- Halogen-free according to IEC 61249-2-21 definition



RoHS
COMPLIANT
HALOGEN
FREE

APPLICATIONS

- PDA/notebook/desktop/server applications
- High current POL converters
- Low profile, high current power supplies
- Battery powered devices
- DC/DC converters in distributed power systems
- DC/DC converter for Field Programmable Gate Array (FPGA)

DIMENSIONS in inches [millimeters]

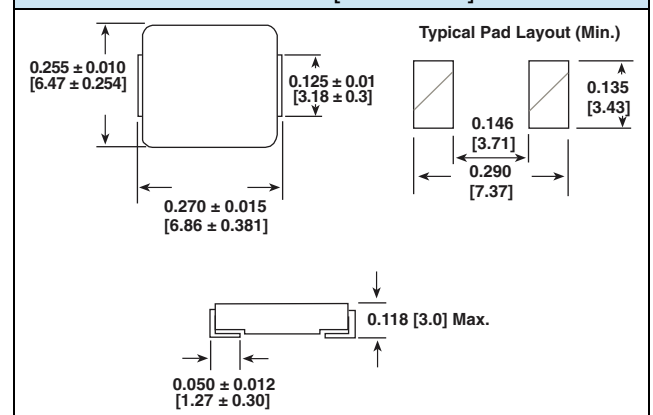

DESCRIPTION

IHLP-2525CZ-11	1.0 µH	± 20 %	ER	e3
MODEL	INDUCTANCE VALUE	INDUCTANCE TOLERANCE	PACKAGE CODE	JEDEC LEAD (Pb)-FREE STANDARD

GLOBAL PART NUMBER

I	H	L	P	2	5	2	5	C	Z	E	R	1	R	0	M	1	1
PRODUCT FAMILY				SIZE				PACKAGE CODE		INDUCTANCE VALUE		TOL.	SERIES				

PERFORMANCE GRAPHS

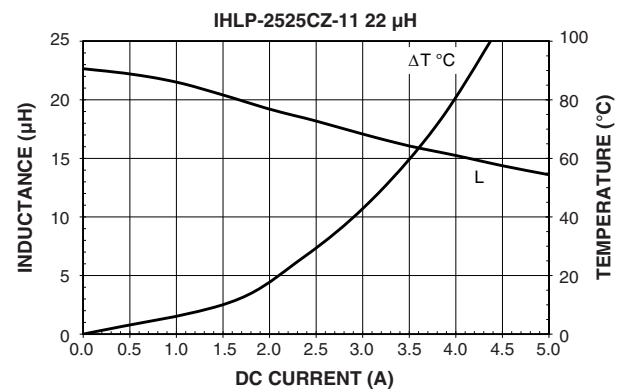
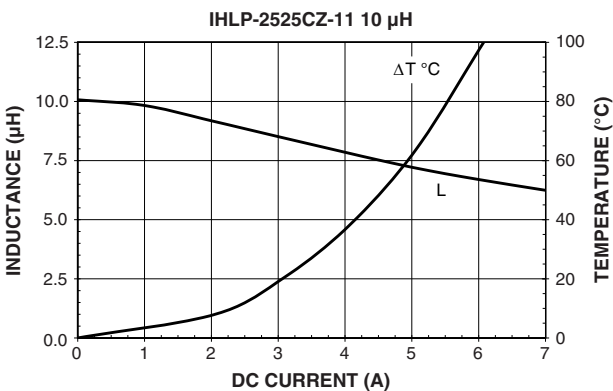
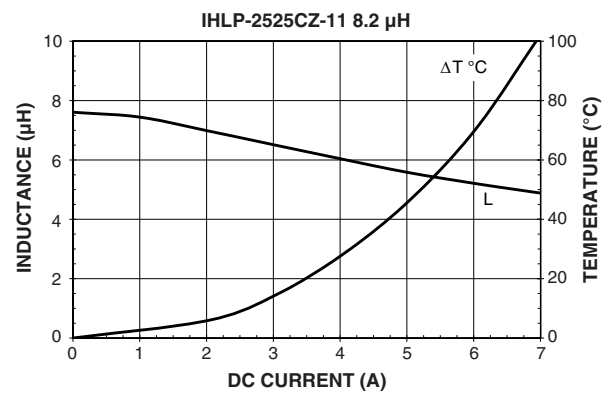
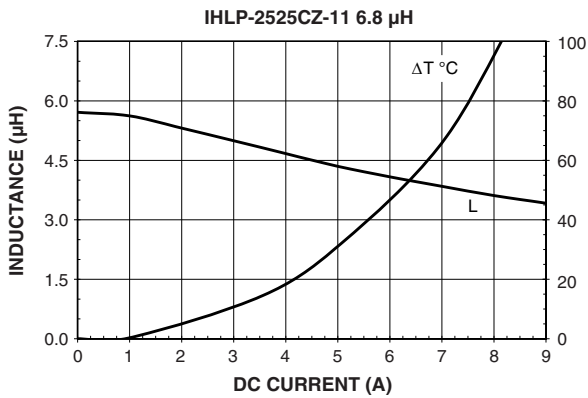
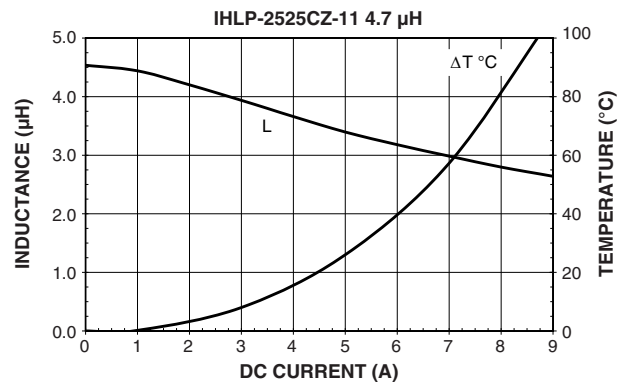
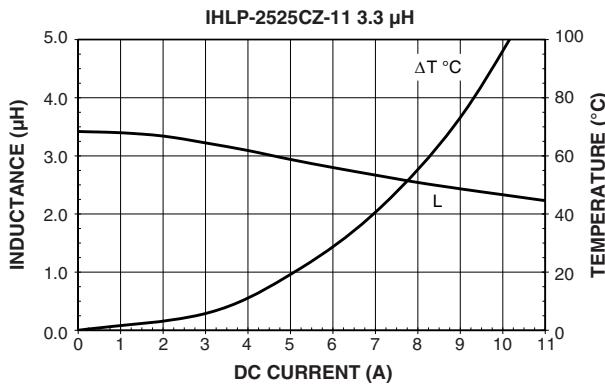
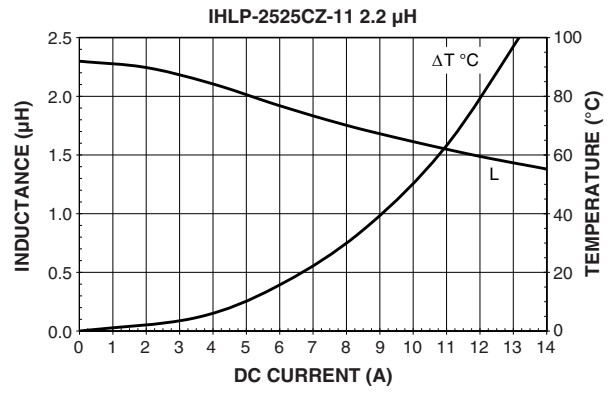
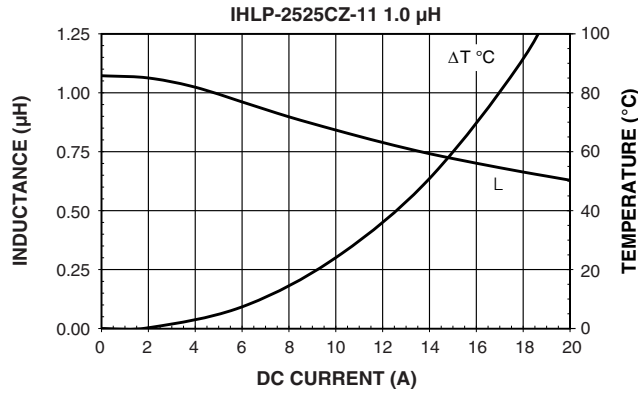

10 % DCR Tolerance, Low Profile, IHLP® Power Inductors

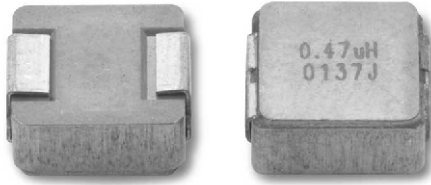

Manufactured under one or more of the following:
US Patents; 6,198,375/6,204,744/6,449,829/6,460,244.
 Several foreign patents, and other patents pending.

FEATURES

- Lowest height (3.0 mm) in this package footprint
- Shielded construction
- Frequency range up to 5.0 MHz
- Lowest DCR/µH, in this package size
- Handles high transient current spikes without saturation
- Ultra low buzz noise, due to composite construction
- Compliant to RoHS directive 2002/95/EC

**RoHS
COMPLIANT**
APPLICATIONS

- Tolerance DCR for current sense applications
- Improved current balance in phased power supplies
- Improved thermal management
- PDA/notebook/desktop/server and battery powered devices
- High current, low profile POL converters
- DC/DC converters in distributed power systems
- DC/DC converter for Field Programmable Gate Array (FPGA)

STANDARD ELECTRICAL SPECIFICATIONS

L_0 INDUCTANCE ± 20 % AT 100 kHz, 0.25 V, 0 A (µH)	DCR ± 10 % AT 25 °C (mΩ)	HEAT RATING CURRENT DC TYP. (A) ⁽³⁾	SATURATION CURRENT DC TYP. (A) ⁽⁴⁾
0.10	1.30	32.5	60
0.20	2.34	24	41
0.33	3.20	20	30
0.47	3.86	17.5	26
0.68	5.20	15.5	25
0.82	7.41	13	24
1.0	8.44	11	22
1.5	14.50	9	18
2.2	17.73	8	14
3.3	28.21	6	13.5
4.7	37.11	5.5	10
8.2	61.47	4	7.5
10	97.71	3	7.0

Notes

- (1) All test data is referenced to 25 °C ambient
- (2) Operating temperature range - 55 °C to + 125 °C
- (3) DC current (A) that will cause an approximate ΔT of 40 °C
- (4) DC current (A) that will cause L_0 to drop approximately 20 %
- (5) The part temperature (ambient + temp. rise) should not exceed 125 °C under worst case operating conditions. Circuit design, component placement, PWB trace size and thickness, airflow and other cooling provisions all affect the part temperature. Part temperature should be verified in the end application.

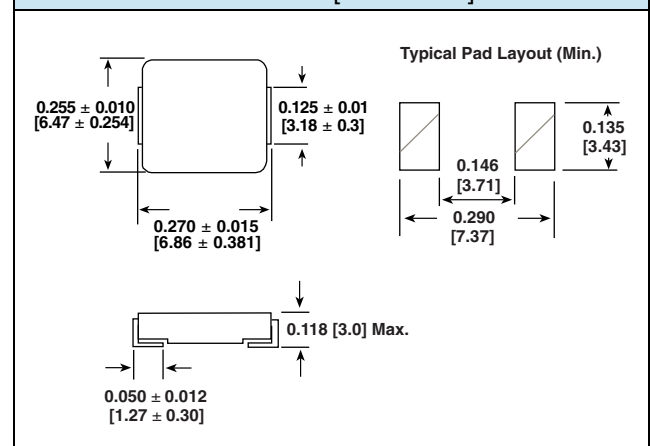
DIMENSIONS in inches [millimeters]

DESCRIPTION

IHLP-2525CZ-06	1.0 µH	± 20 %	ER	e3
MODEL	INDUCTANCE VALUE	INDUCTANCE TOLERANCE	PACKAGE CODE	JEDEC LEAD (Pb)-FREE STANDARD

GLOBAL PART NUMBER

I	H	L	P	2	5	2	5	C	Z	E	R	1	R	0	M	0	6
PRODUCT FAMILY				SIZE				PACKAGE CODE		INDUCTANCE VALUE			TOL.	SERIES			

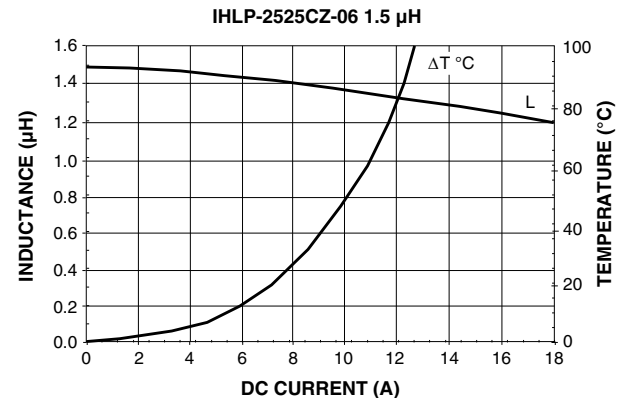
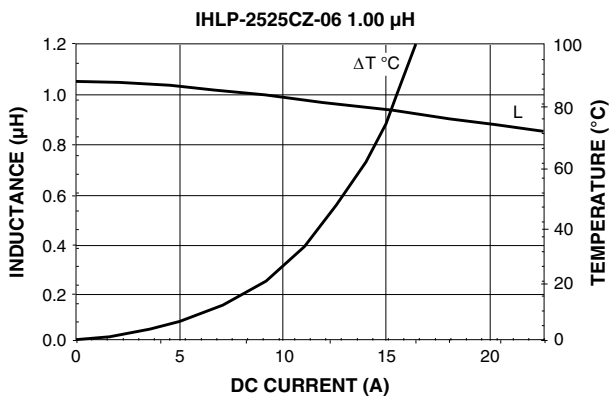
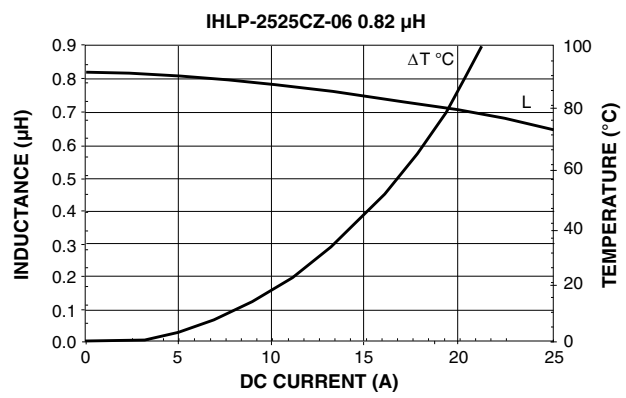
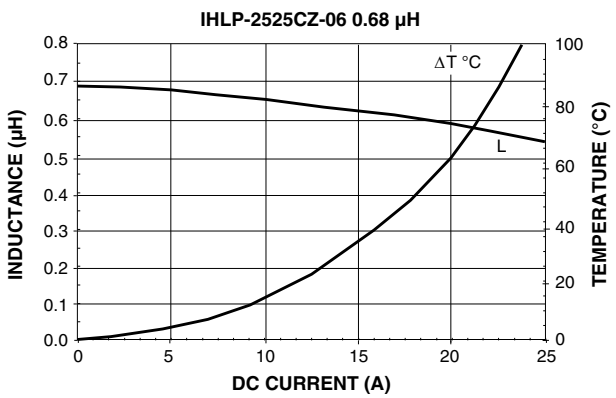
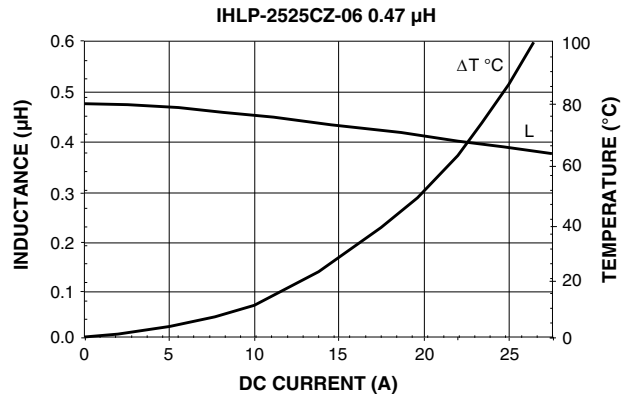
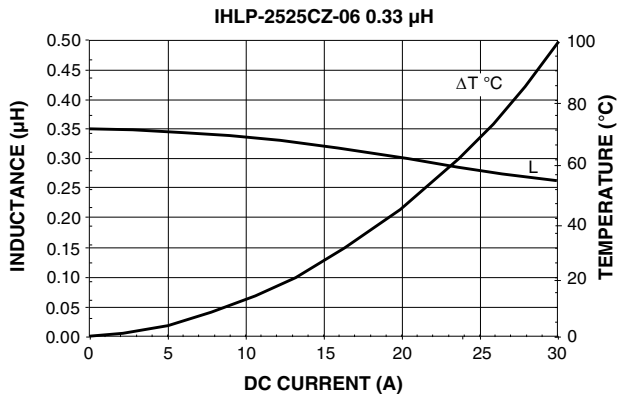
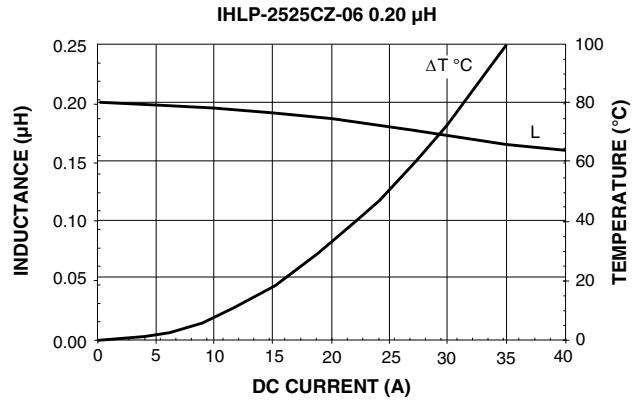
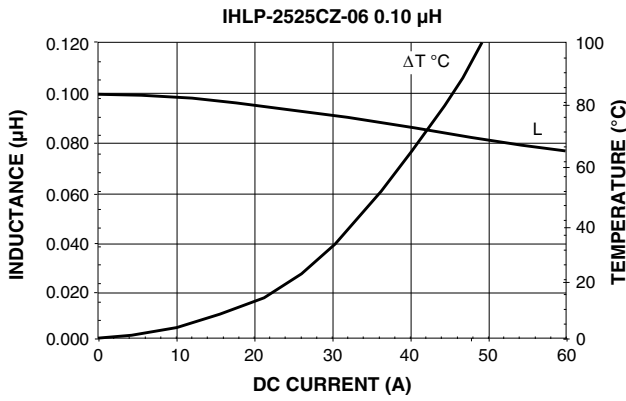
PERFORMANCE GRAPHS





PERFORMANCE GRAPHS

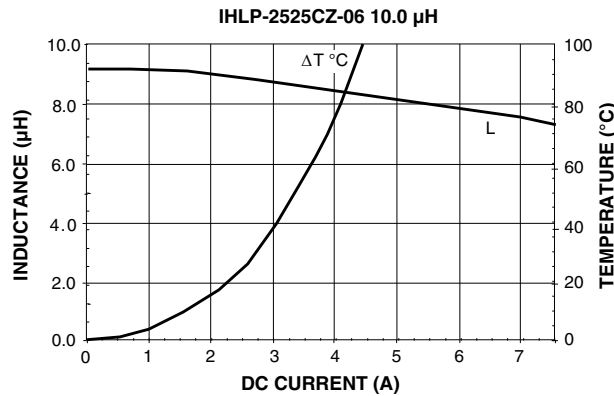
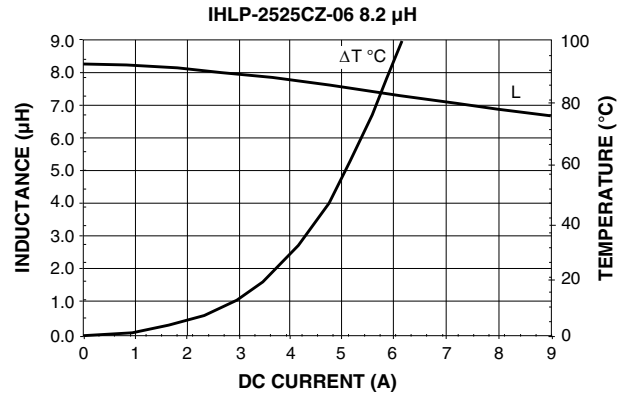
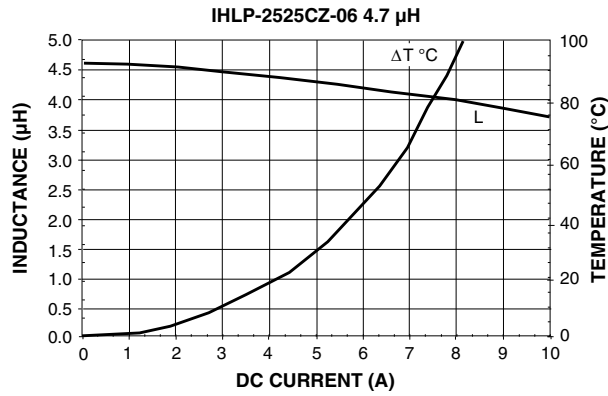
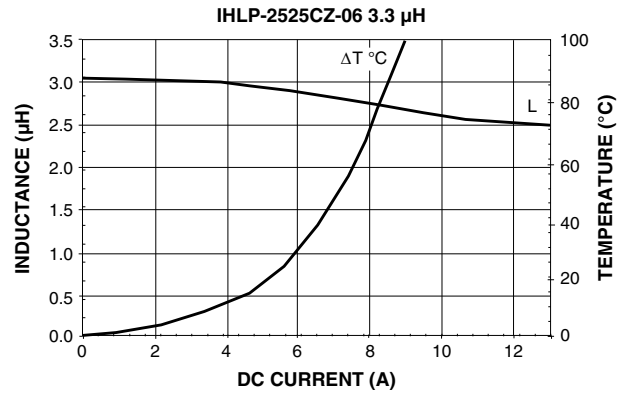
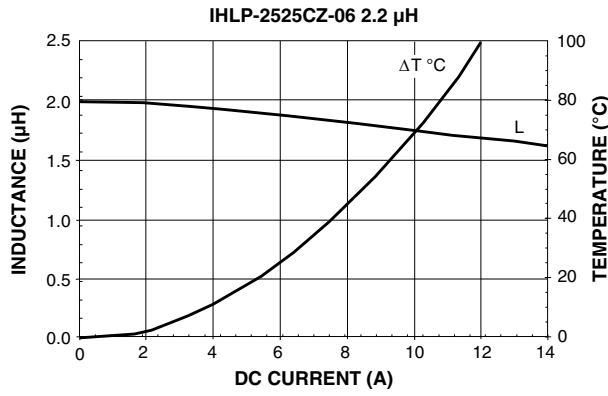

5 % DCR Tolerance, Low Profile, IHLP® Power Inductors

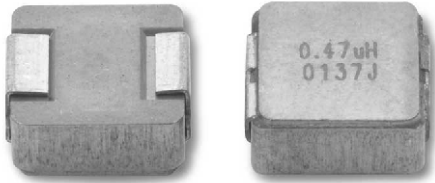

Manufactured under one or more of the following:
US Patents; 6,198,375/6,204,744/6,449,829/6,460,244.
 Several foreign patents, and other patents pending.

FEATURES

- Lowest height (3.0 mm) in this package footprint
- Shielded construction
- Frequency range up to 5.0 MHz
- Lowest DCR/ μH , in this package size
- Handles high transient current spikes without saturation
- Ultra low buzz noise, due to composite construction
- Compliant to RoHS directive 2002/95/EC



RoHS
COMPLIANT

APPLICATIONS

- Tolerance DCR for current sense applications
- Improved current balance in phased power supplies
- Improved thermal management
- PDA/notebook/desktop/server and battery powered devices
- High current, low profile POL converters
- DC/DC converters in distributed power systems
- DC/DC converter for Field Programmable Gate Array (FPGA)

STANDARD ELECTRICAL SPECIFICATIONS			
L_0 INDUCTANCE $\pm 20\%$ AT 100 kHz, 0.25 V, 0 A (μH)	DCR $\pm 5\%$ AT 25 °C (m Ω)	HEAT RATING CURRENT DC TYP. (A) ⁽³⁾	SATURATION CURRENT DC TYP. (A) ⁽⁴⁾
0.10	1.30	32.5	60
0.15	1.85	26	52
0.20	2.34	24	41
0.33	3.20	20	30
0.47	3.86	17.5	26
0.68	5.20	15.5	25
0.82	7.41	13	24
1.0	8.44	11	22
1.5	14.50	9	18
2.2	17.73	8	14
3.3	28.21	6	13.5
4.7	37.11	5.5	10
8.2	61.47	4	7.5
10	97.71	3	7.0

Notes

- (1) All test data is referenced to 25 °C ambient
- (2) Operating temperature range - 55 °C to + 125 °C
- (3) DC current (A) that will cause an approximate ΔT of 40 °C
- (4) DC current (A) that will cause L_0 to drop approximately 20 %
- (5) The part temperature (ambient + temp. rise) should not exceed 125 °C under worst case operating conditions. Circuit design, component placement, PWB trace size and thickness, airflow and other cooling provisions all affect the part temperature. Part temperature should be verified in the end application.

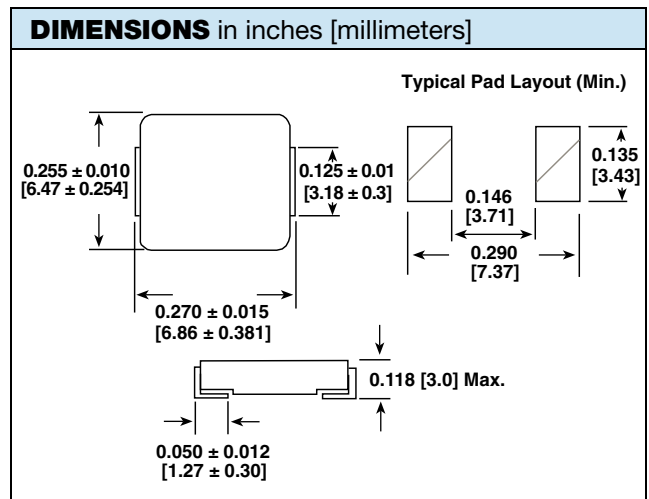

DESCRIPTION				
IHLP-2525CZ-07	1.0 μH	$\pm 20\%$	ER	e3
MODEL	INDUCTANCE VALUE	INDUCTANCE TOLERANCE	PACKAGE CODE	JEDEC LEAD (Pb)-FREE STANDARD

GLOBAL PART NUMBER																	
I	H	L	P	2	5	2	5	C	Z	E	R	1	R	0	M	0	7
PRODUCT FAMILY				SIZE				PACKAGE CODE		INDUCTANCE VALUE			TOL.	SERIES			



PERFORMANCE GRAPHS

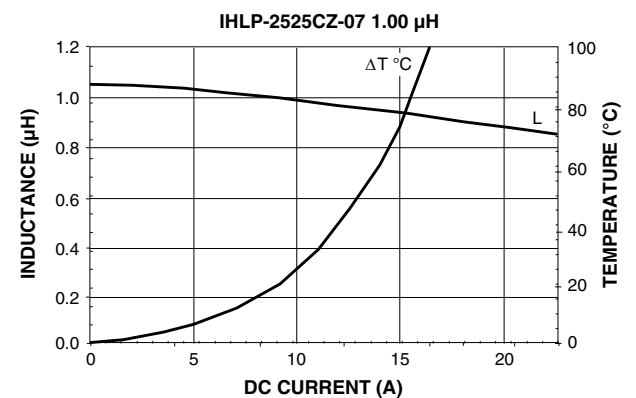
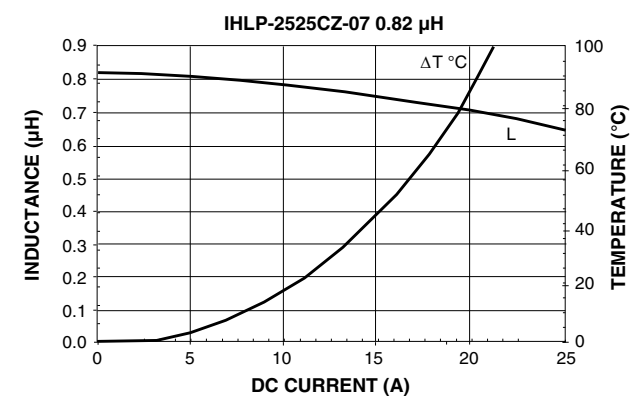
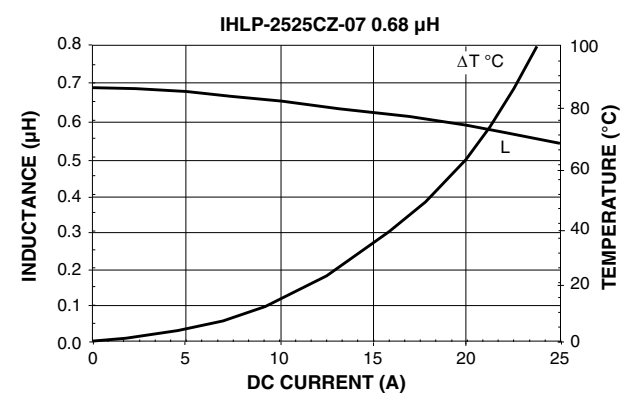
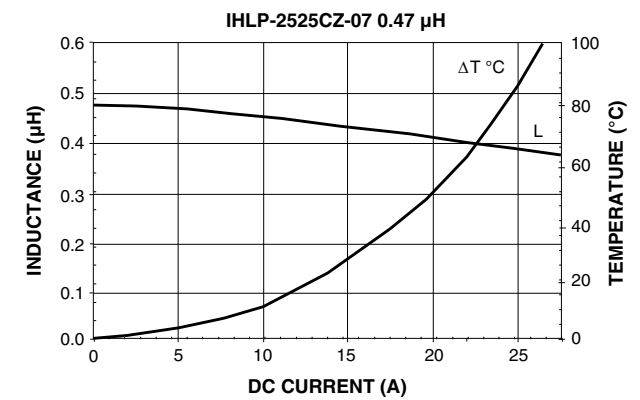
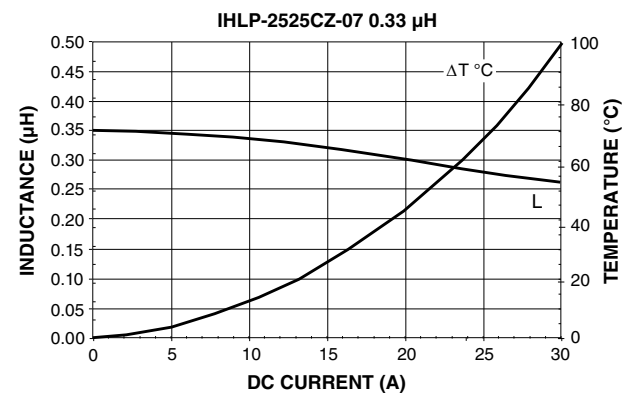
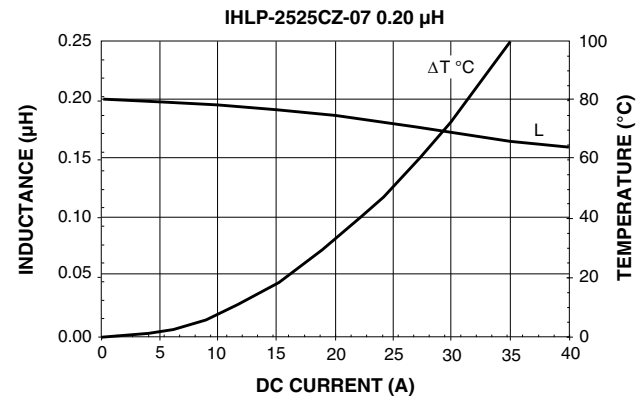
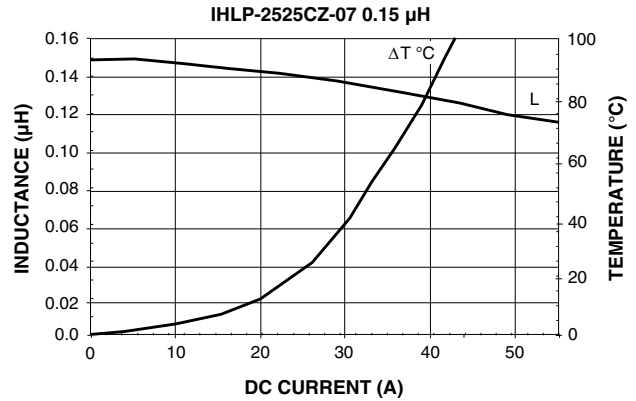
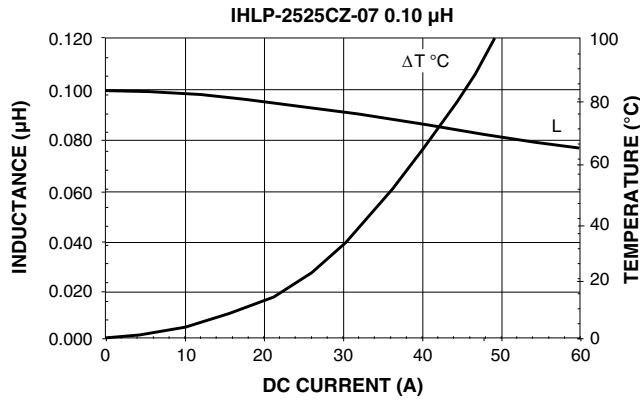

PERFORMANCE GRAPHS

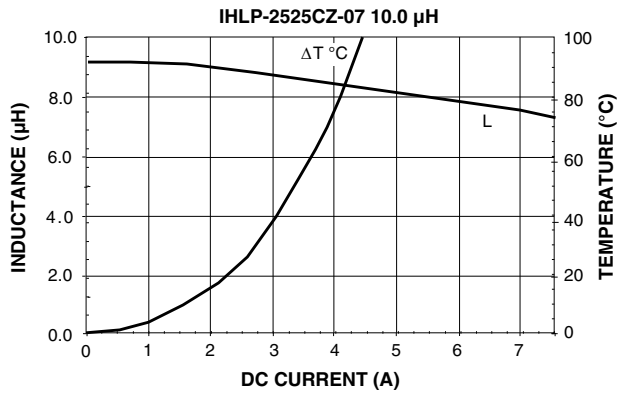
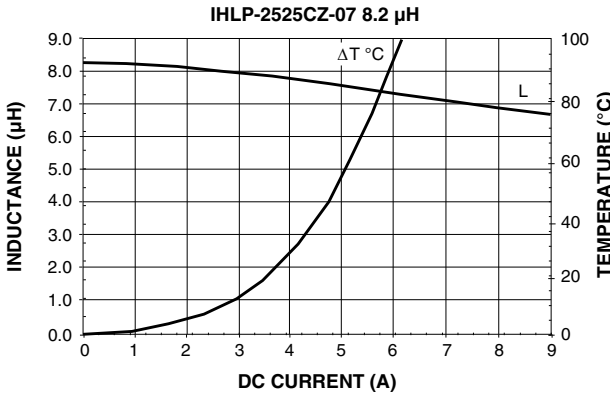
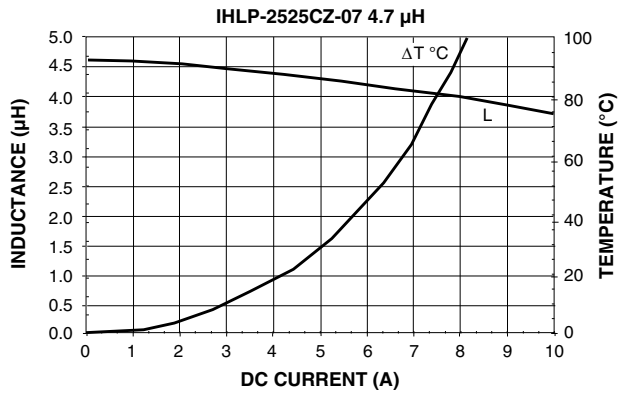
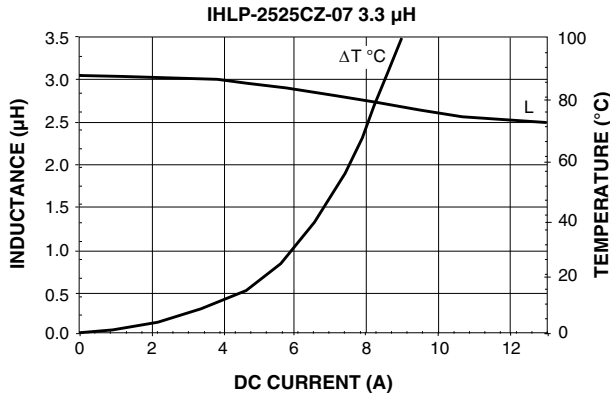
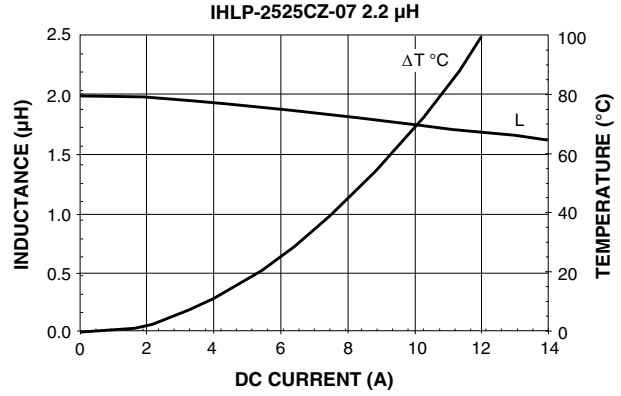
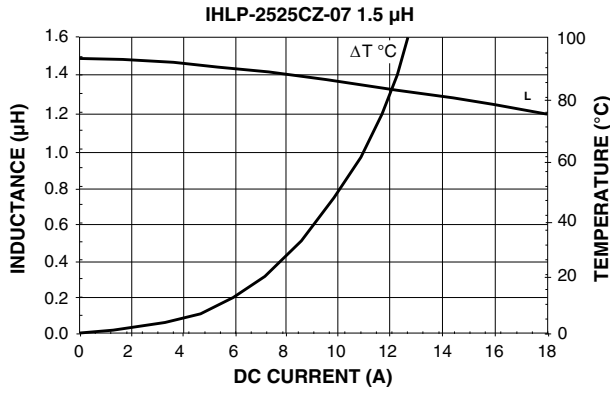

Low Profile, High Current IHLP® Inductors

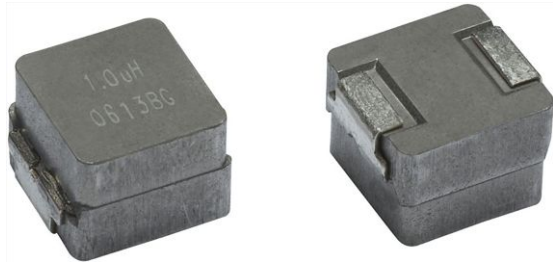

Manufactured under one or more of the following:
US Patents; 6,198,375/6,204,744/6,449,829/6,460,244.
 Several foreign patents, and other patents pending.

STANDARD ELECTRICAL SPECIFICATIONS				
L_0 INDUCTANCE ± 20 % AT 100 kHz, 0.25 V, 0 A (μ H)	DCR TYP. 25 °C (m Ω)	DCR MAX. 25 °C (m Ω)	HEAT RATING CURRENT DC TYP. (A) ⁽³⁾	SATURATION CURRENT DC TYP. (A) ⁽⁴⁾
0.56	3.4	3.6	20	12
0.68	4.2	4.5	18	11.5
0.82	4.6	4.9	16.5	13
1.0	5.6	6.5	13	15
1.5	8.6	9.0	12	12
2.2	13.0	13.6	10	10
3.3	19.9	20.9	8	8
4.7	28.9	30.3	6.5	7
5.6	32.7	34.4	6	7
6.8	42.5	44.6	5.5	5.5
8.2	48.3	50.7	5.0	5.0
10.0	67.9	71.3	4.5	4.5

Notes

- (1) All test data is referenced to 25 °C ambient
- (2) Operating temperature range - 55 °C to + 125 °C
- (3) DC current (A) that will cause an approximate ΔT of 40 °C
- (4) DC current (A) that will cause L_0 to drop approximately 20 %
- (5) The part temperature (ambient + temp. rise) should not exceed 125 °C under worst case operating conditions. Circuit design, component placement, PWB trace size and thickness, airflow and other cooling provisions all affect the part temperature. Part temperature should be verified in the end application.

FEATURES

- Shielded construction
- Frequency range below 1.0 MHz
- Lowest DCR/ μ H, in this package size
- Powdered iron composition provides soft saturation
- Handles high transient current spikes without saturation
- Saturation and inductance extremely stable over temperature
- Ultra low buzz noise, due to composite construction
- Compliant to RoHS Directive 2002/95/EC



RoHS
 COMPLIANT
GREEN
 (5-2008)**

APPLICATIONS

- Notebook/desktop/server applications
- High current POL converters
- Low profile, high current power supplies
- DC/DC converters in distributed power systems
- DC/DC converter for Field Programmable Gate Array (FPGA)

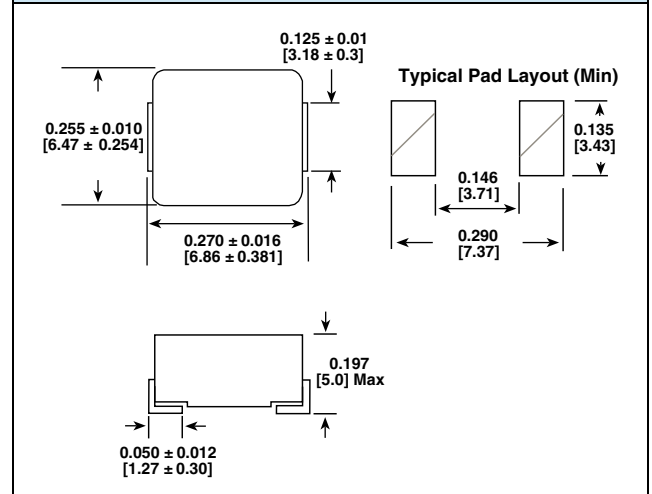
DIMENSIONS in inches [millimeters]

DESCRIPTION

IHLP-2525EZ-01	1.0 μH	± 20 %	ER	e3
MODEL	INDUCTANCE VALUE	INDUCTANCE TOLERANCE	PACKAGE CODE	JEDEC LEAD (Pb)-FREE STANDARD

GLOBAL PART NUMBER

I	H	L	P	2	5	2	5	E	Z	E	R	1	R	0	M	0	1
PRODUCT FAMILY				SIZE				PACKAGE CODE		INDUCTANCE VALUE			TOL.	SERIES			

** Please see document "Vishay Material Category Policy": www.vishay.com/doc?99902

PERFORMANCE GRAPHS

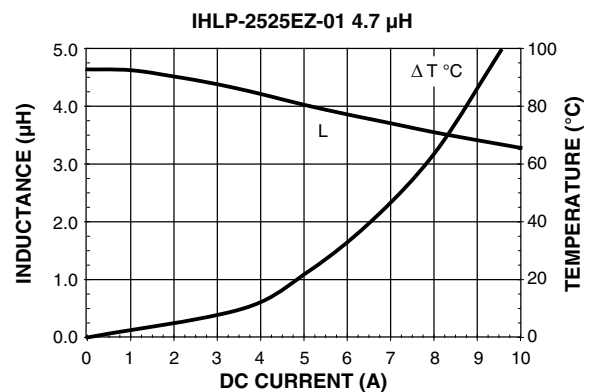
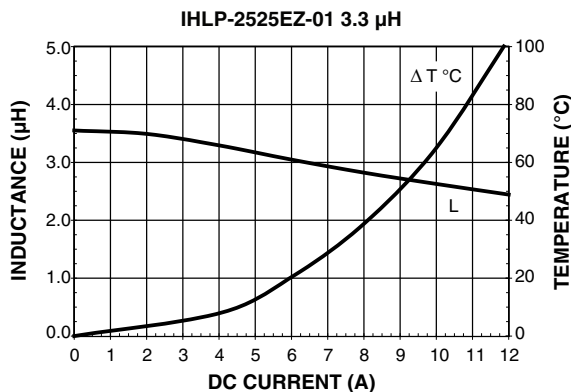
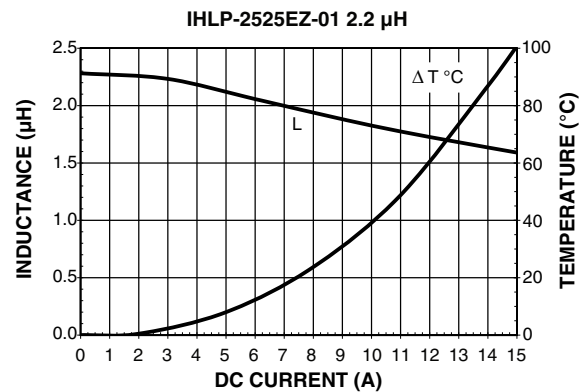
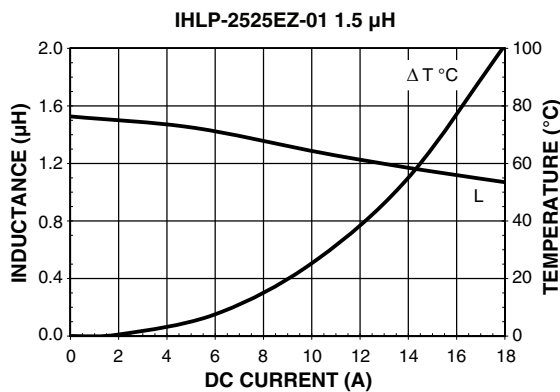
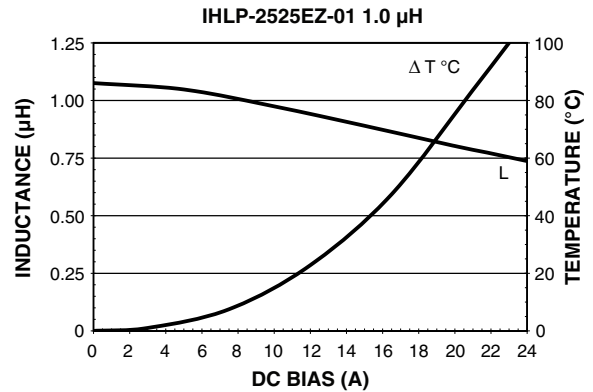
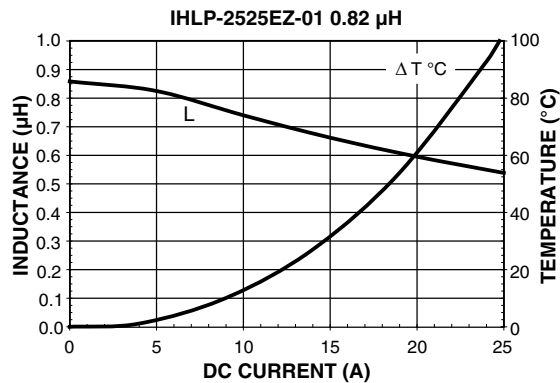
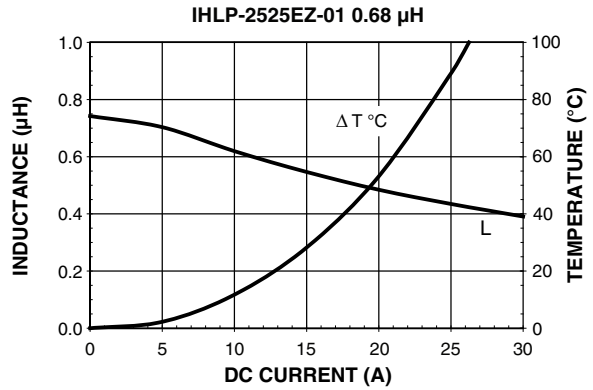
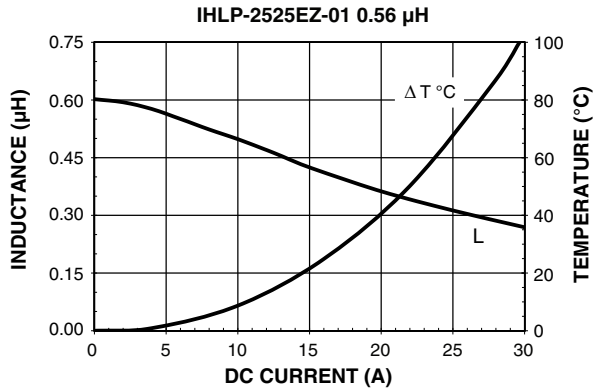



PERFORMANCE GRAPHS

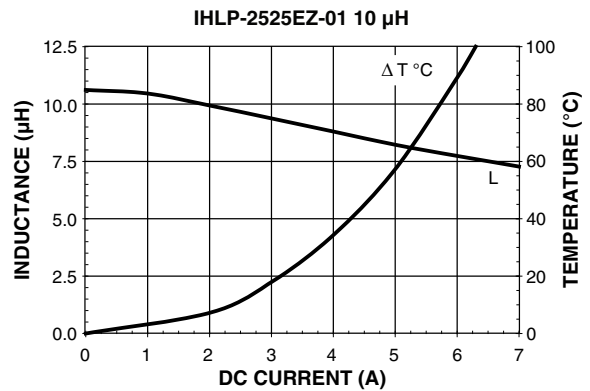
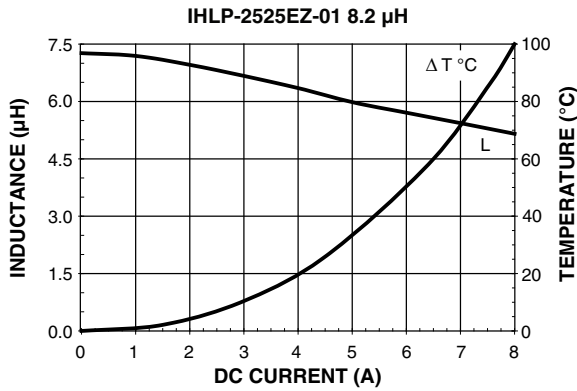
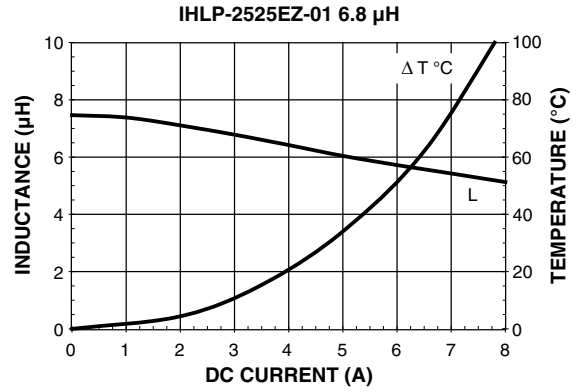
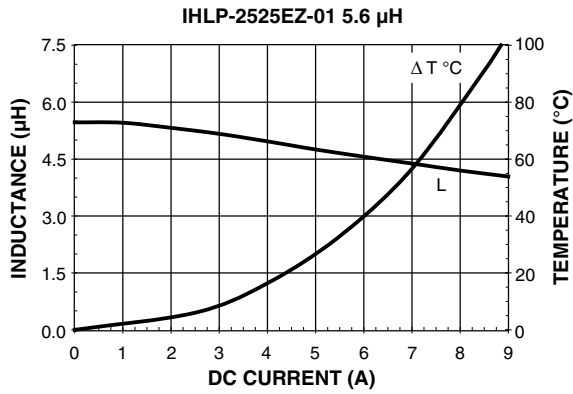

Low Profile, High Current IHLP® Inductors



Manufactured under one or more of the following:
US Patents; 6,198,375/6,204,744/6,449,829/6,460,244.
 Several foreign patents, and other patents pending.

STANDARD ELECTRICAL SPECIFICATIONS				
L ₀ INDUCTANCE ± 20 % AT 100 kHz, 0.25 V, 0 A (μH)	DCR TYP. 25 °C (mΩ)	DCR MAX. 25 °C (mΩ)	HEAT RATING CURRENT DC TYP. (A) ⁽³⁾	SATURATION CURRENT DC TYP. (A) ⁽⁴⁾
0.22	1.50	1.61	32.0	43.0
0.33	2.40	2.57	25.0	32.0
0.47	3.11	3.33	21.5	35.0
1.0	7.80	8.35	13.7	29.0
1.5	12.40	13.30	11.0	24.0
2.2	19.00	20.30	9.0	21.0
3.3	25.60	27.40	7.2	12.0
4.7	32.00	34.20	6.6	10.5
5.6	34.70	37.20	6.3	10.0
6.8	46.10	49.30	5.3	9.5
8.2	55.40	59.30	4.8	9.5
10.0	66.50	71.20	4.7	8.2

Notes

- (1) All test data is referenced to 25 °C ambient
- (2) Operating temperature range - 55 °C to + 125 °C
- (3) DC current (A) that will cause an approximate ΔT of 40 °C
- (4) DC current (A) that will cause L₀ to drop approximately 20 %
- (5) The part temperature (ambient + temp. rise) should not exceed 125 °C under worst case operating conditions. Circuit design, component placement, PWB trace size and thickness, airflow and other cooling provisions all affect the part temperature. Part temperature should be verified in the end application.

FEATURES

- Shielded construction
- Frequency range up to 5 MHz
- Operating temperature up to 125 °C
- Lowest DCR/μH, in this package size
- Handles high transient current spikes without saturation
- Ultra low buzz noise, due to composite construction
- Compliant to RoHS Directive 2002/95/EC

RoHS
 COMPLIANT

APPLICATIONS

- PDA/notebook/desktop/server applications
- High current POL converters
- Low profile, high current power supplies
- Battery powered device
- DC/DC converters in distributed power systems
- DC/DC converter for Field Programmable Gate Array (FPGA)

DIMENSIONS in inches [millimeters]

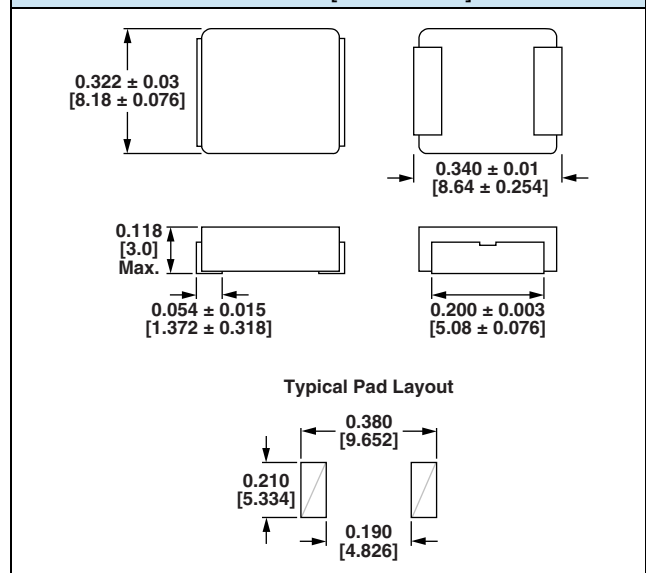

DESCRIPTION

IHLP-3232CZ-01	4.7 μH	± 20 %	ER	e3
MODEL	INDUCTANCE VALUE	INDUCTANCE TOLERANCE	PACKAGE CODE	JEDEC LEAD (Pb)-FREE STANDARD

GLOBAL PART NUMBER

I	H	L	P	3	2	3	2	C	Z	E	R	4	R	7	M	0	1
PRODUCT FAMILY				SIZE				PACKAGE CODE		INDUCTANCE VALUE			TOL.	SERIES			



PERFORMANCE GRAPHS

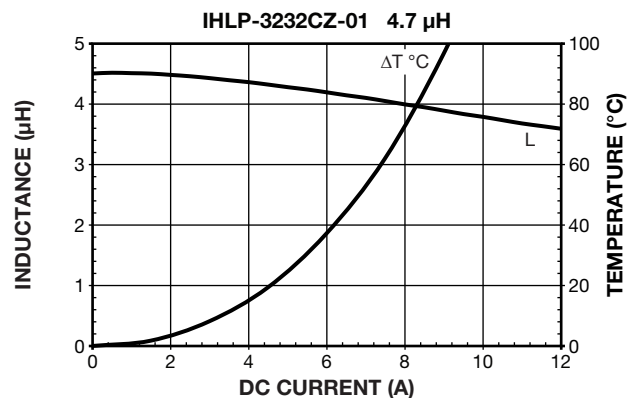
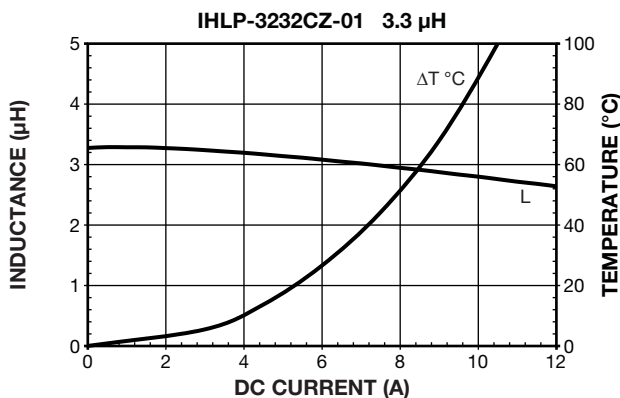
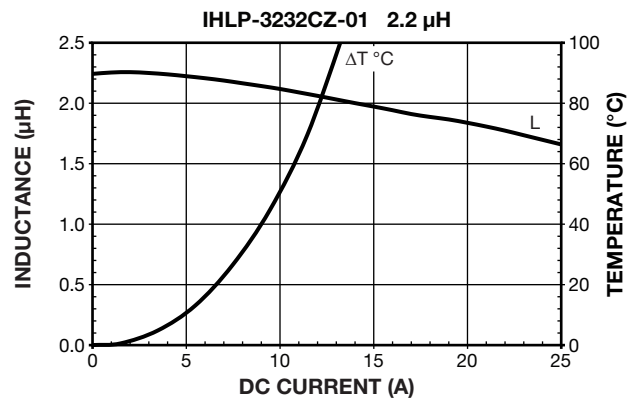
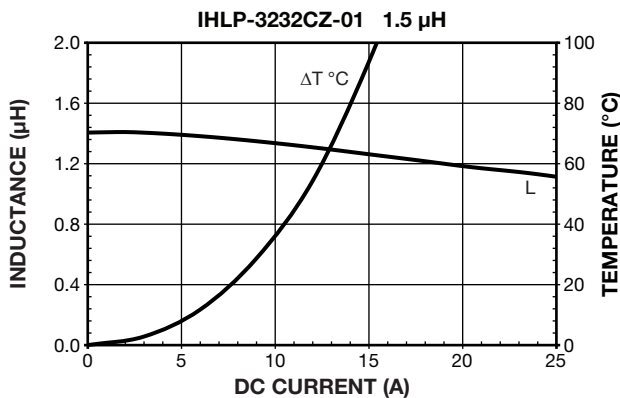
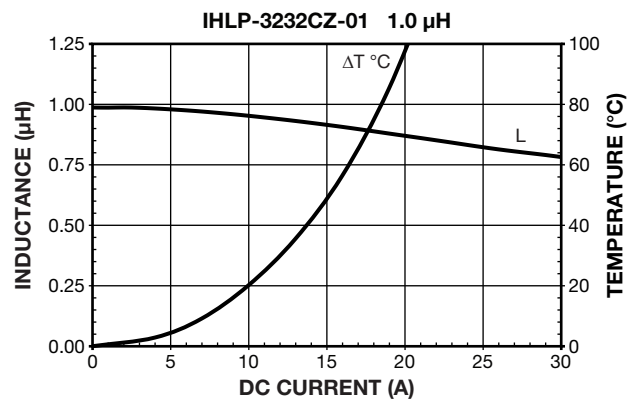
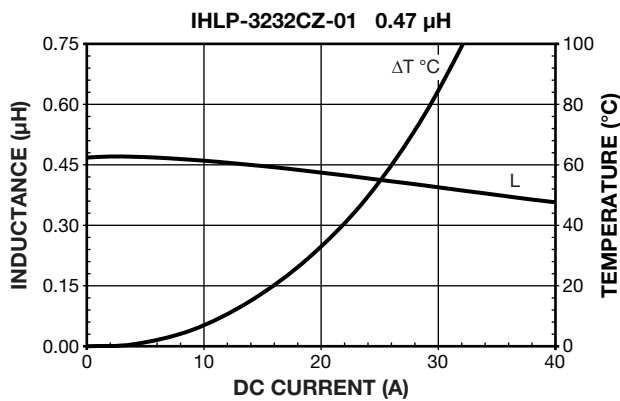
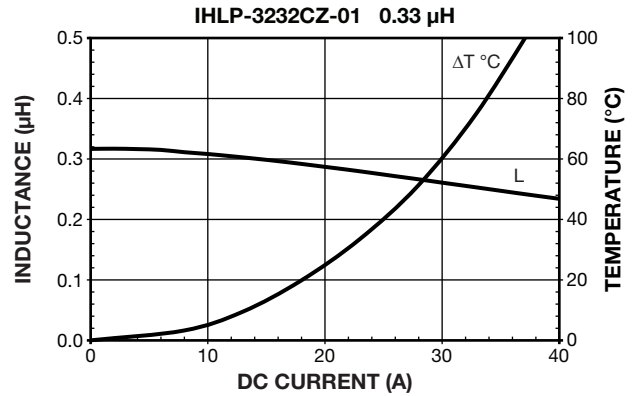
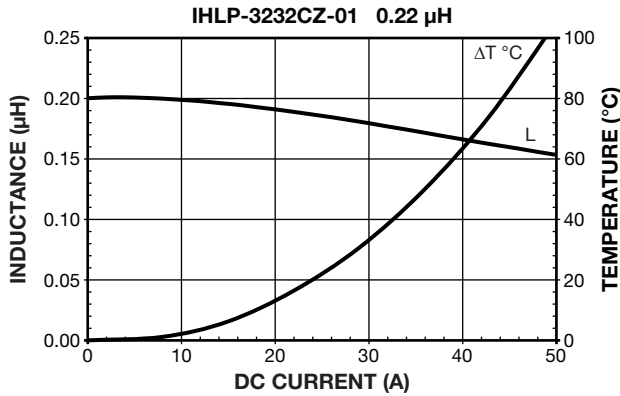



PERFORMANCE GRAPHS

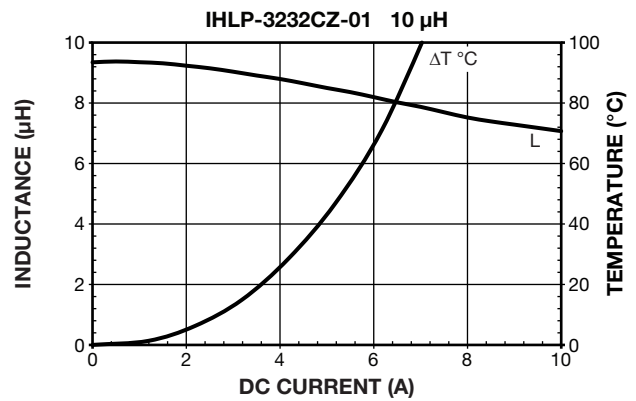
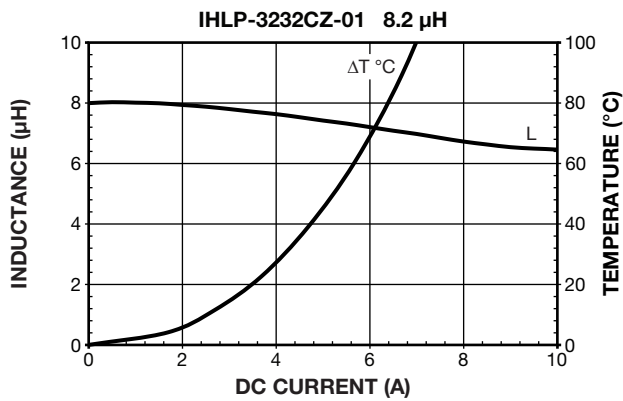
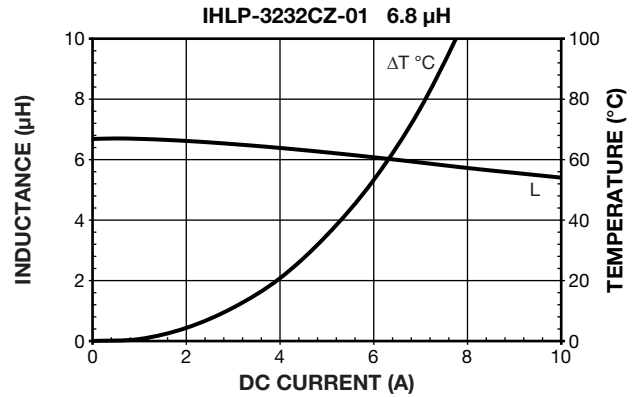
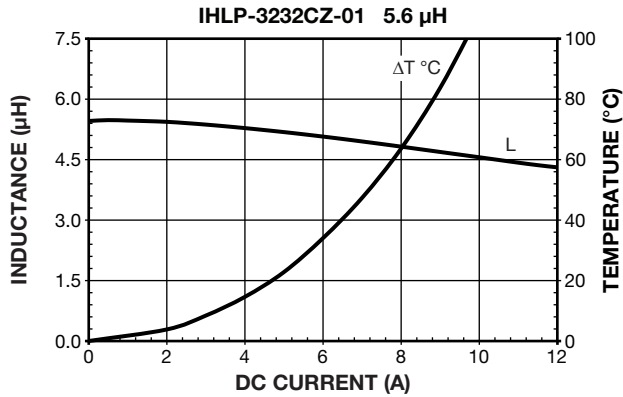



PERFORMANCE GRAPHS: INDUCTANCE AND Q VS. FREQUENCY

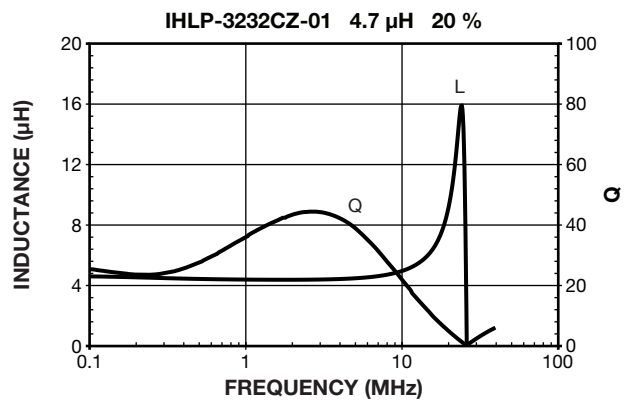
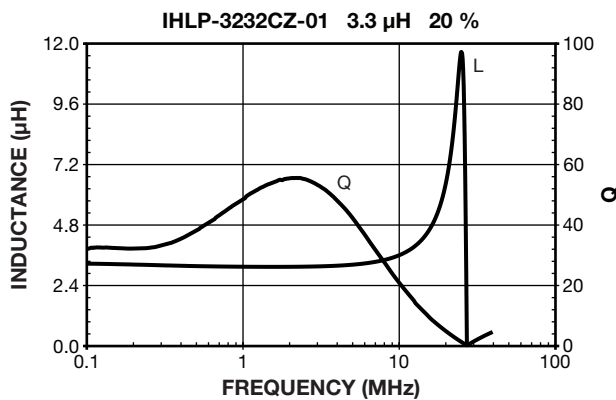
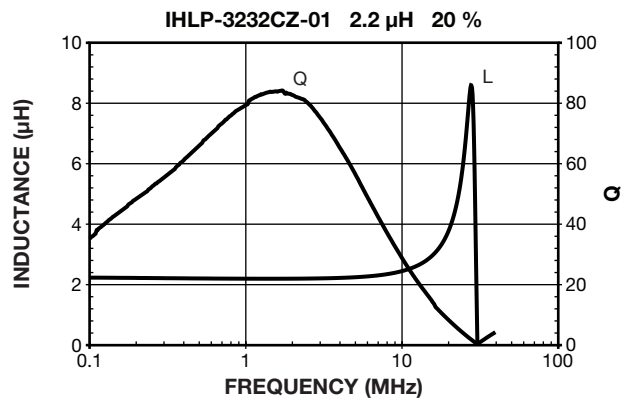
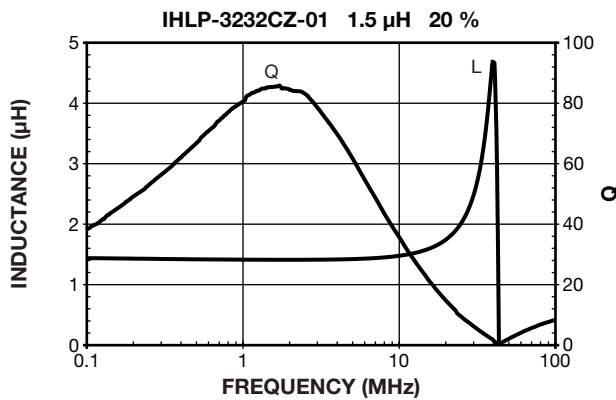
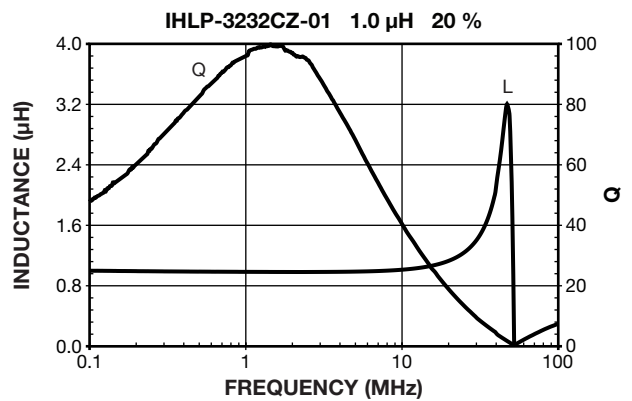
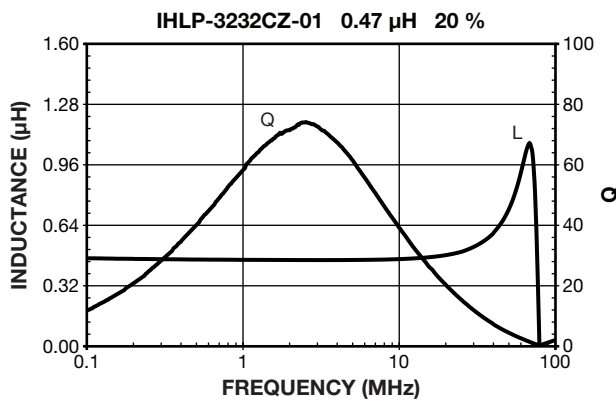
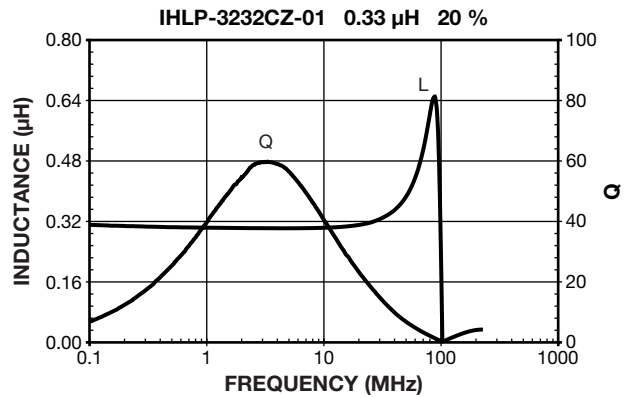
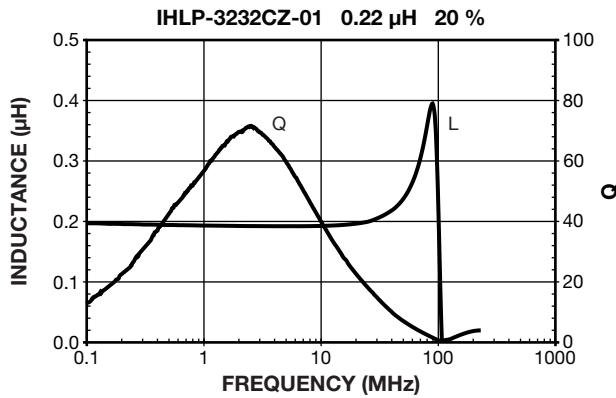



PERFORMANCE GRAPHS: INDUCTANCE AND Q VS. FREQUENCY

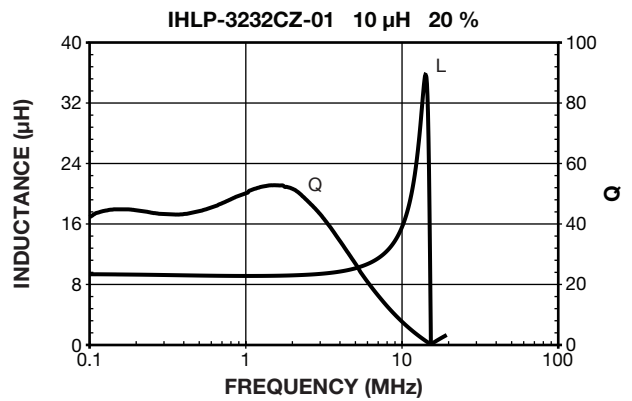
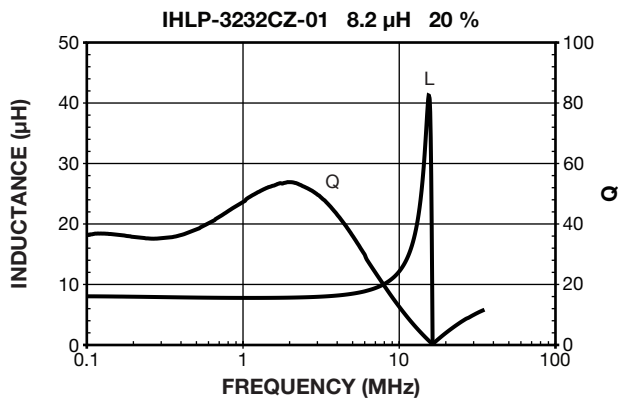
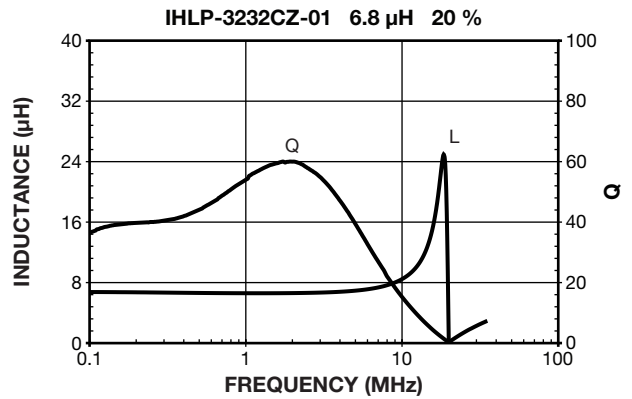
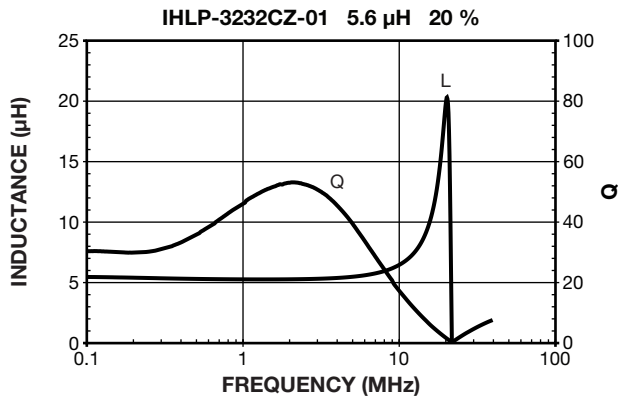

Low Profile, High Current IHLP® Inductors



Manufactured under one or more of the following:
US Patents; 6,198,375/6,204,744/6,449,829/6,460,244.
 Several foreign patents, and other patents pending.

STANDARD ELECTRICAL SPECIFICATIONS				
L_0 INDUCTANCE ± 20 % AT 100 kHz, 0.25 V, 0 A (μ H)	DCR TYP. 25 °C (m Ω)	DCR MAX. 25 °C (m Ω)	HEAT RATING CURRENT DC TYP. (A) ⁽³⁾	SATURATION CURRENT DC TYP. (A) ⁽⁴⁾
0.22	1.51	1.62	36.0	24.0
0.33	2.22	2.38	27.0	18.0
0.47	2.54	2.72	24.0	18.0
0.68	3.73	3.99	20.0	15.2
0.82	4.55	4.87	18.5	15.0
1.0	6.07	6.49	16.0	14.8
1.5	8.29	9.94	12.5	11.3
2.2	13.70	14.70	10.4	10.4
4.7	26.70	28.60	7.6	5.4
6.8	35.30	37.80	6.5	5.0
8.2	43.60	46.70	5.9	4.2
10	51.50	55.10	5.3	3.8
15	79.70	85.30	4.3	3.8
22	123.0	132.0	3.6	2.8
33	192.0	205.0	2.6	2.5

Notes

- (1) All test data is referenced to 25 °C ambient
- (2) Operating temperature range - 55 °C to + 125 °C
- (3) DC current (A) that will cause an approximate ΔT of 40 °C
- (4) DC current (A) that will cause L_0 to drop approximately 20 %
- (5) The part temperature (ambient + temp. rise) should not exceed 125 °C under worst case operating conditions. Circuit design, component placement, PWB trace size and thickness, airflow and other cooling provisions all affect the part temperature. Part temperature should be verified in the end application.

FEATURES

- Shielded construction
- Frequency range up to 1 MHz
- Operating temperature up to 125 °C
- Lowest DCR/ μ H, in this package size
- Handles high transient current spikes without saturation
- Ultra low buzz noise, due to composite construction
- Compliant to RoHS Directive 2002/95/EC

RoHS
 COMPLIANT

APPLICATIONS

- PDA/notebook/desktop/server applications
- High current POL converters
- Low profile, high current power supplies
- Battery powered device
- DC/DC converters in distributed power systems
- DC/DC converter for Field Programmable Gate Array (FPGA)

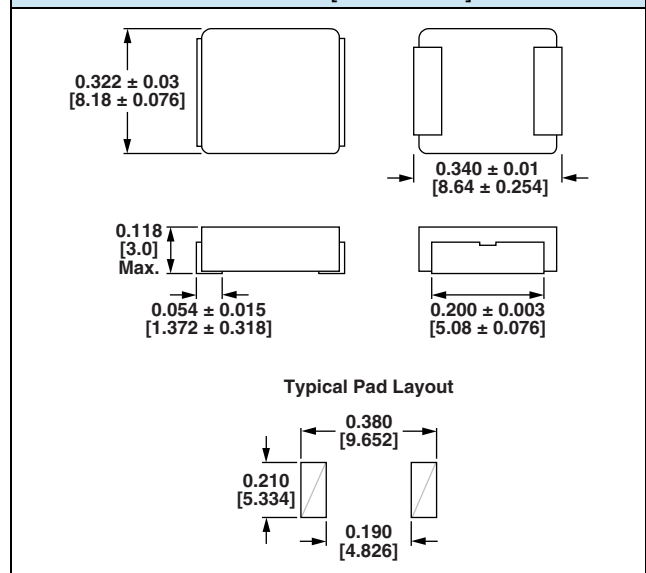
DIMENSIONS in inches [millimeters]

DESCRIPTION

IHLP-3232CZ-11	4.7 μ H	± 20 %	ER	e3
MODEL	INDUCTANCE VALUE	INDUCTANCE TOLERANCE	PACKAGE CODE	JEDEC LEAD (Pb)-FREE STANDARD

GLOBAL PART NUMBER

I	H	L	P	3	2	3	2	C	Z	E	R	4	R	7	M	1	1
PRODUCT FAMILY				SIZE				PACKAGE CODE		INDUCTANCE VALUE			TOL.	SERIES			



PERFORMANCE GRAPHS

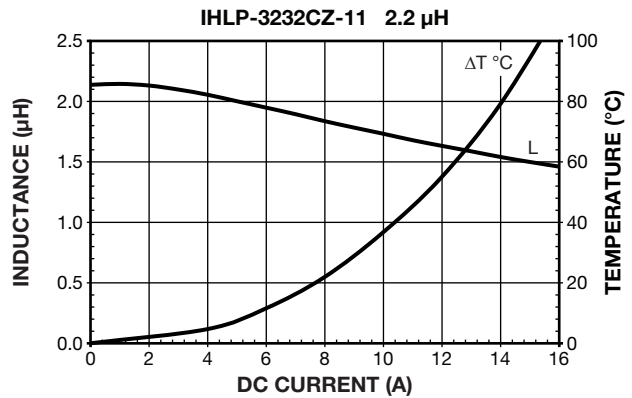
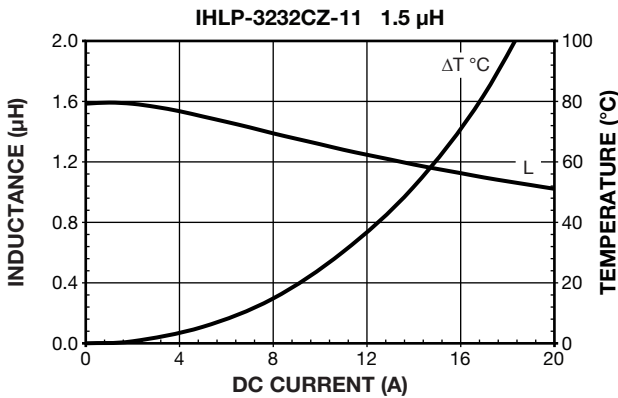
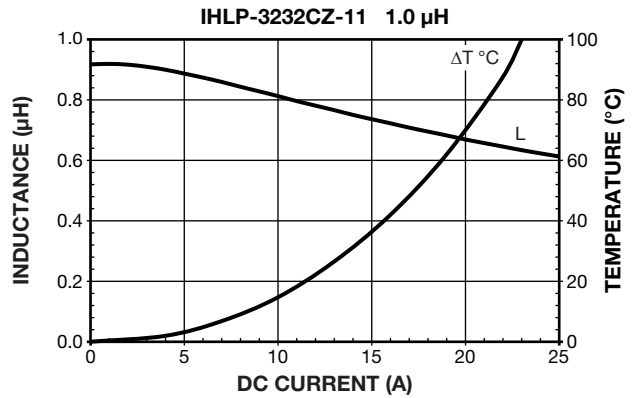
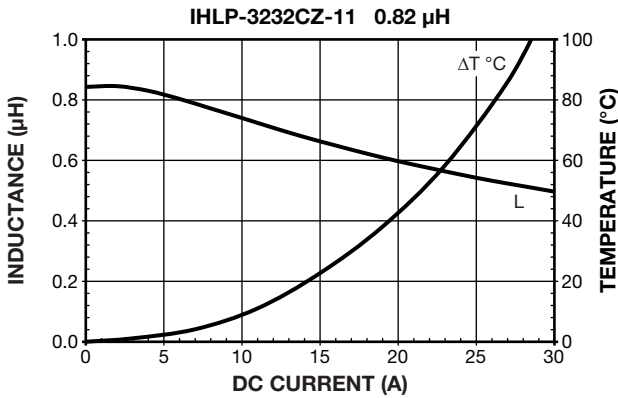
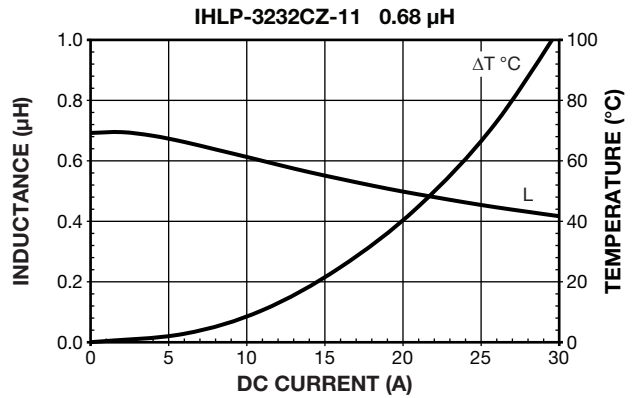
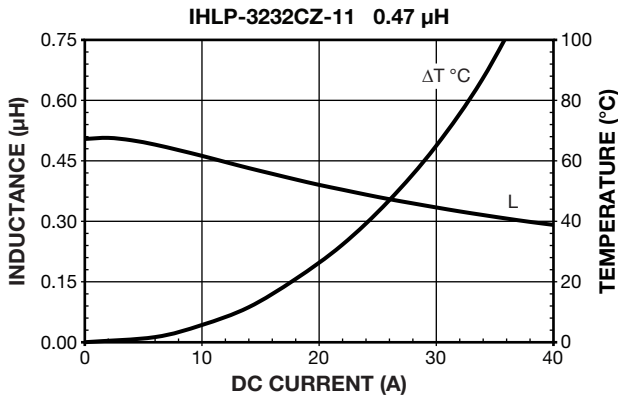
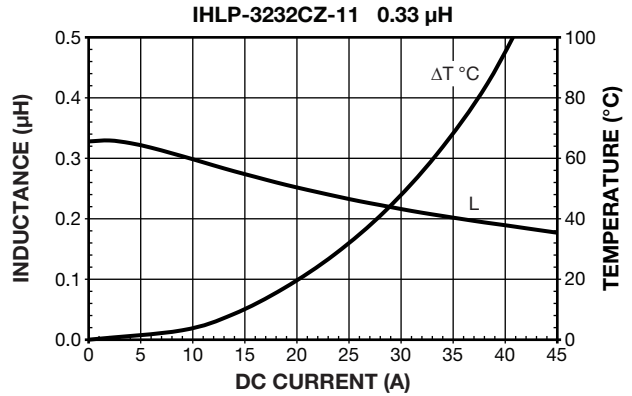
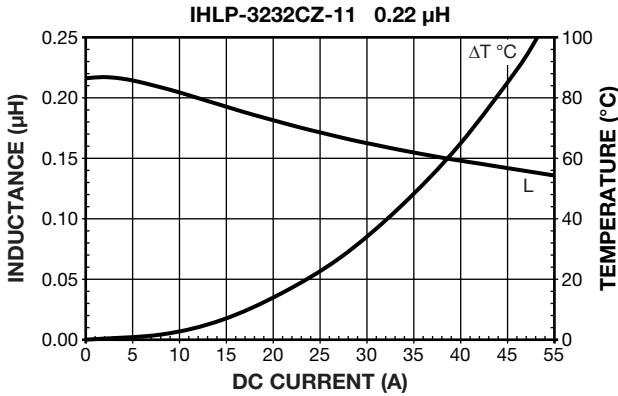



PERFORMANCE GRAPHS

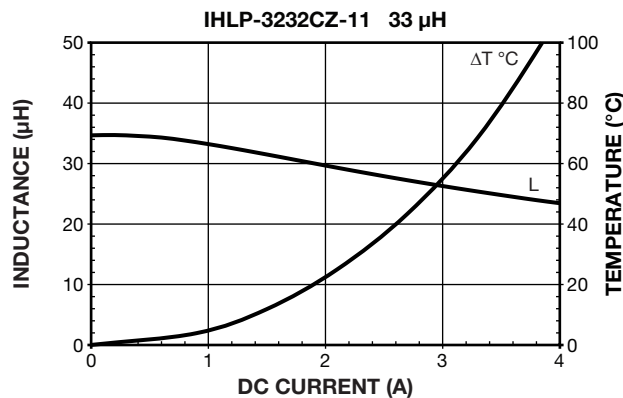
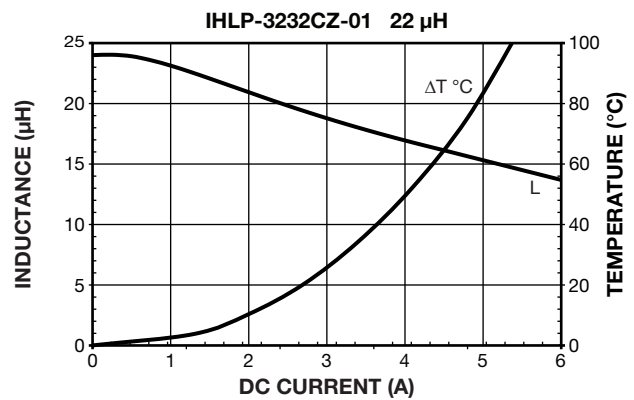
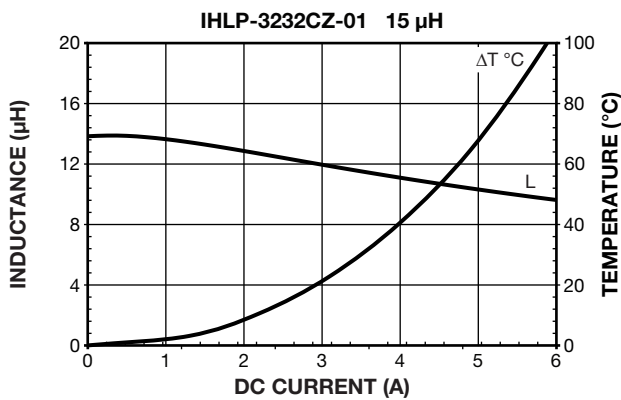
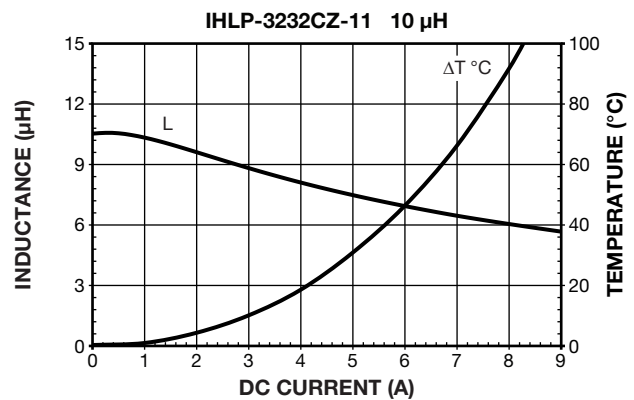
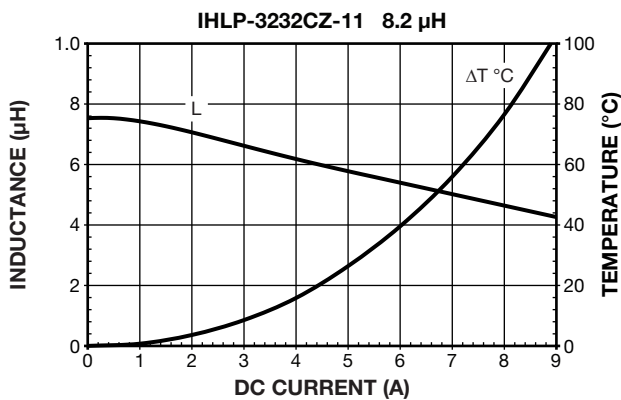
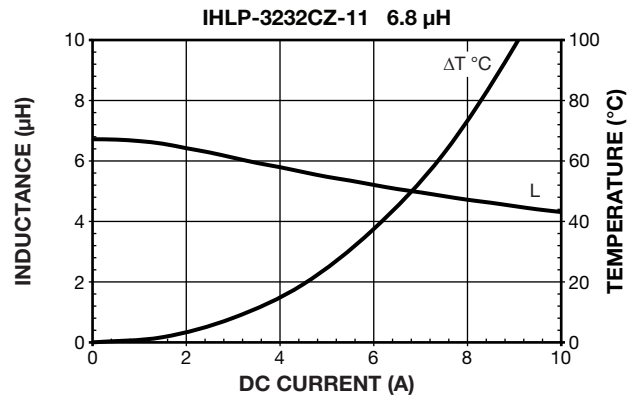
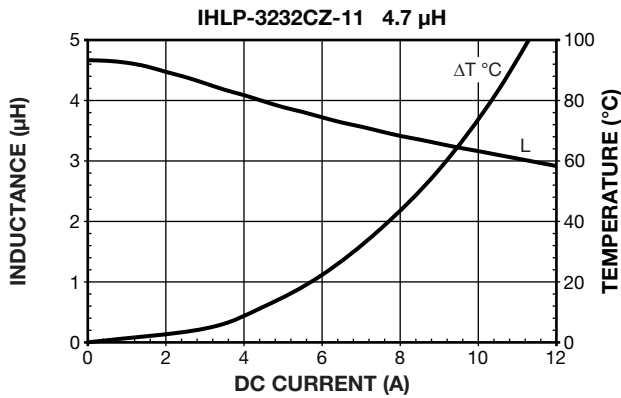



PERFORMANCE GRAPHS: INDUCTANCE AND Q VS. FREQUENCY

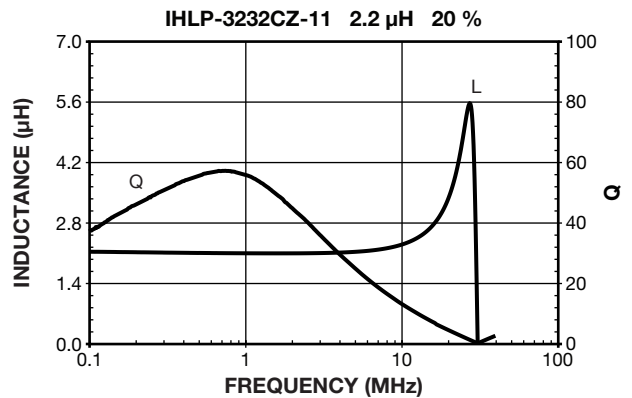
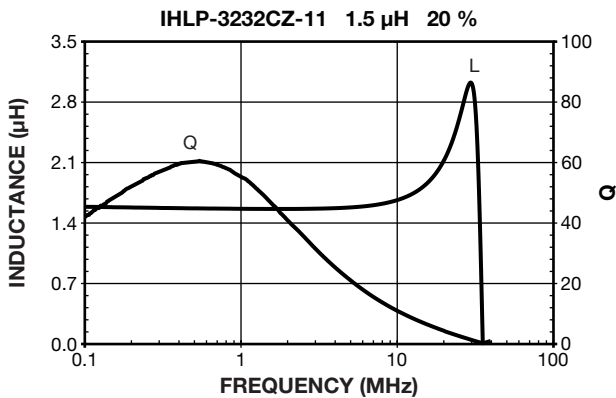
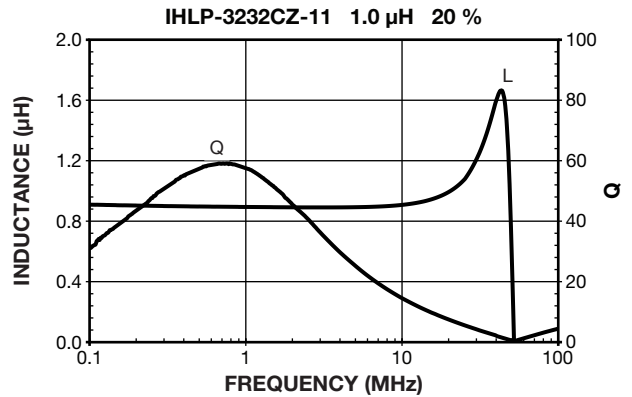
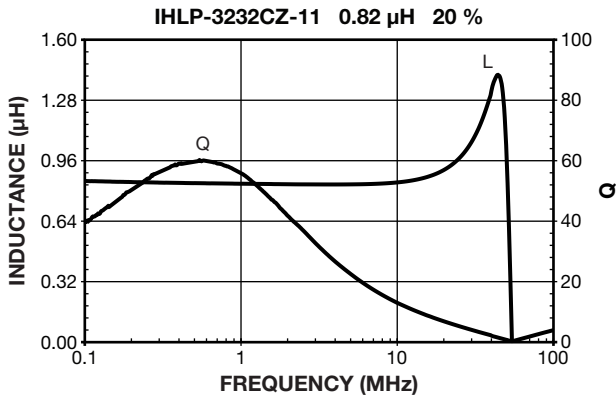
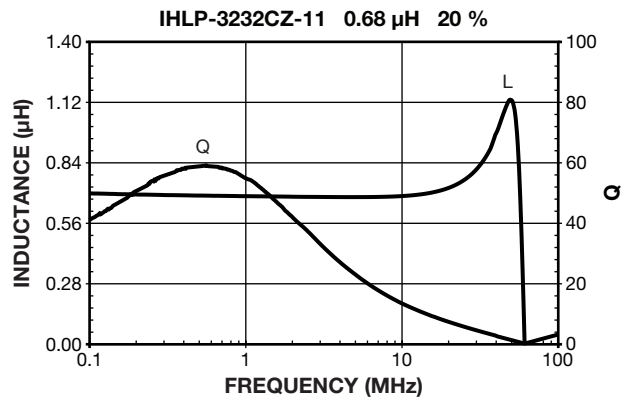
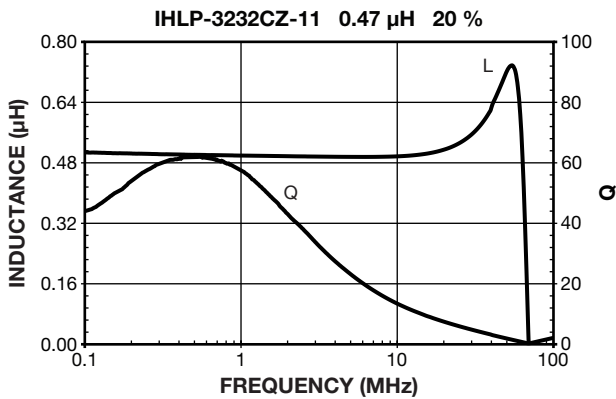
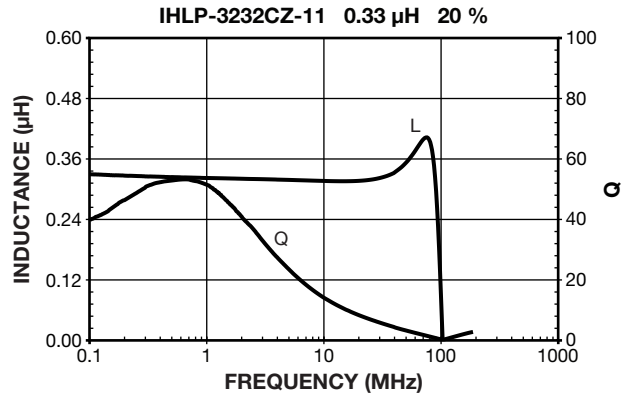
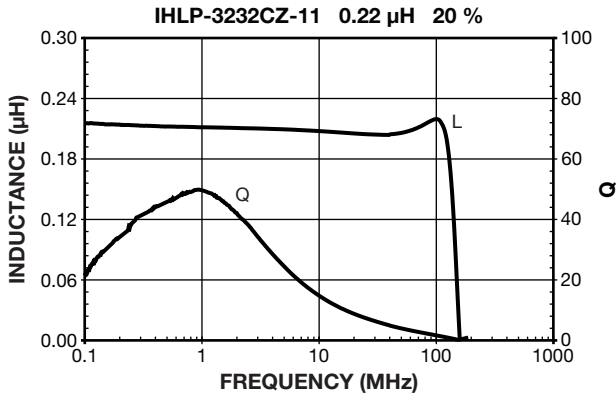



PERFORMANCE GRAPHS: INDUCTANCE AND Q VS. FREQUENCY

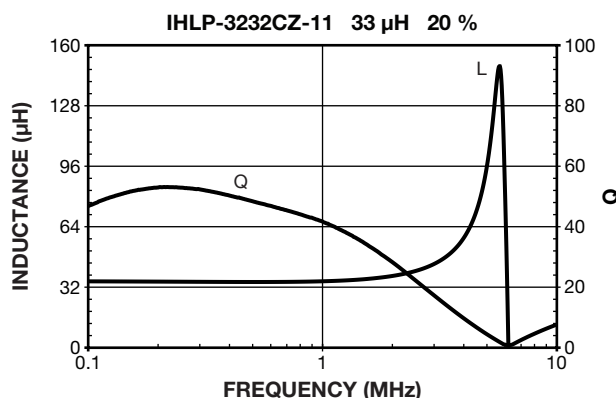
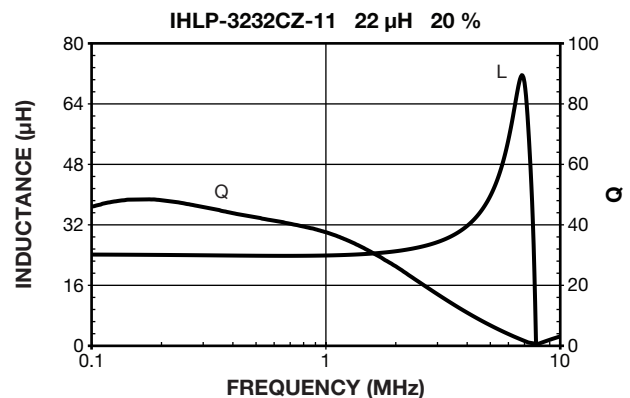
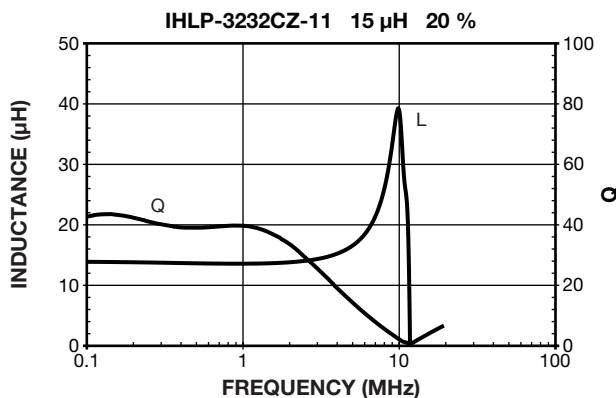
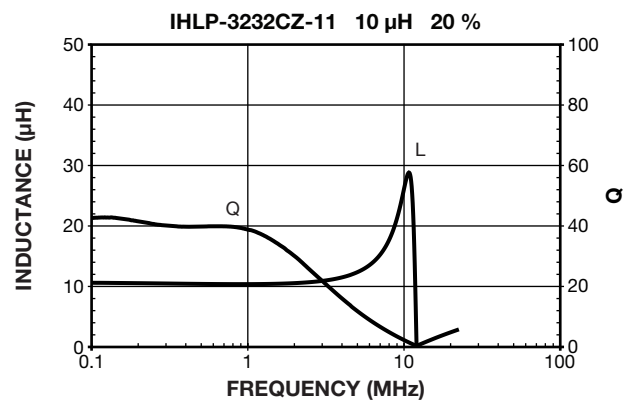
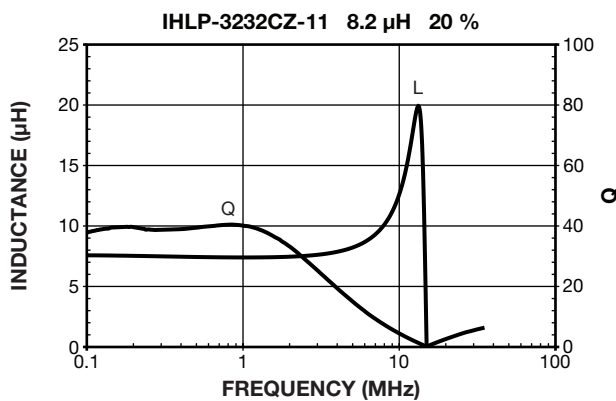
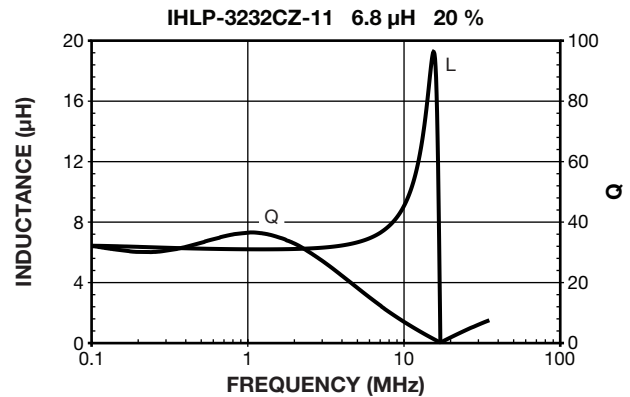
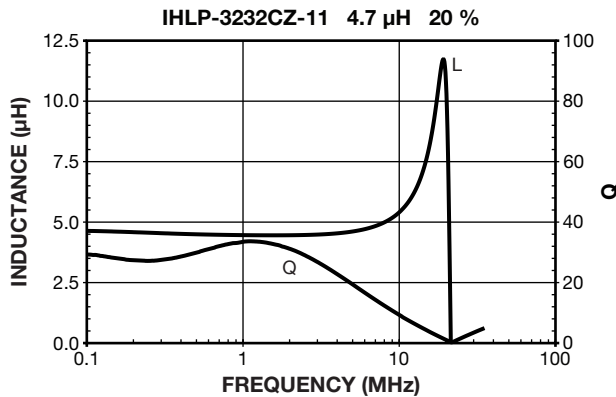

Low Profile, High Current IHLP® Inductors



Manufactured under one or more of the following:
US Patents; 6,198,375/6,204,744/6,449,829/6,460,244.
 Several foreign patents, and other patents pending.

STANDARD ELECTRICAL SPECIFICATIONS				
L ₀ INDUCTANCE ± 20 % AT 100 kHz, 0.25 V, 0 A (μH)	DCR TYP. 25 °C (mΩ)	DCR MAX. 25 °C (mΩ)	HEAT RATING CURRENT DC TYP. (A) ⁽³⁾	SATURATION CURRENT DC TYP. (A) ⁽⁴⁾
0.22	1.57	1.68	30.7	34.0
0.33	2.00	2.14	29.5	36.0
0.47	2.45	2.62	25.0	31.5
0.68	3.43	3.67	21.0	24.5
0.82	4.13	4.42	19.0	24.2
1.0	5.40	5.78	18.0	24.0
2.2	12.80	13.70	10.5	23.0
3.3	16.50	17.70	9.2	20.0
4.7	29.90	32.00	7.5	18.7
5.6	33.20	35.50	6.8	16.7
6.8	44.60	47.70	5.7	15.2
8.2	47.50	50.80	5.5	10.0
10.0	56.00	59.90	5.2	9.0

Notes

- (1) All test data is referenced to 25 °C ambient
- (2) Operating temperature range - 55 °C to + 125 °C
- (3) DC current (A) that will cause an approximate ΔT of 40 °C
- (4) DC current (A) that will cause L₀ to drop approximately 20 %
- (5) The part temperature (ambient + temp. rise) should not exceed 125 °C under worst case operating conditions. Circuit design, component placement, PWB trace size and thickness, airflow and other cooling provisions all affect the part temperature. Part temperature should be verified in the end application.

FEATURES

- Shielded construction
- Frequency range up to 5 MHz
- Operating temperature up to 125 °C
- Lowest DCR/μH, in this package size
- Handles high transient current spikes without saturation
- Ultra low buzz noise, due to composite construction
- Compliant to RoHS Directive 2002/95/EC



RoHS
 COMPLIANT
GREEN
 [5-2008]**

Note

** Please see document "Vishay Material Category Policy":
www.vishay.com/doc?99902

APPLICATIONS

- PDA/notebook/desktop/server applications
- High current POL converters
- Low profile, high current power supplies
- Battery powered device
- DC/DC converters in distributed power systems
- DC/DC converter for Field Programmable Gate Array (FPGA)

DIMENSIONS in inches [millimeters]

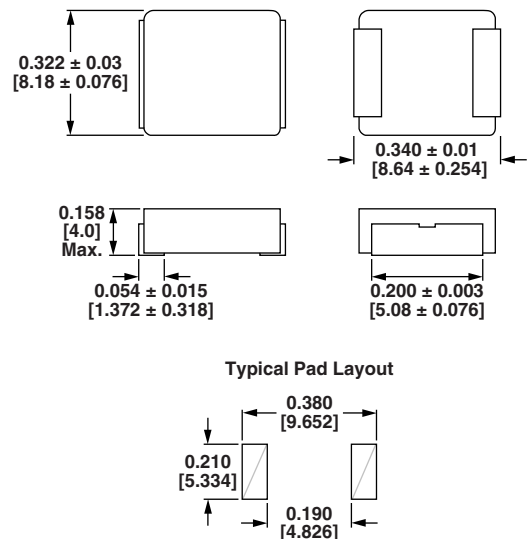

DESCRIPTION				
IHLP-3232DZ-01	4.7 μH	± 20 %	ER	e3
MODEL	INDUCTANCE VALUE	INDUCTANCE TOLERANCE	PACKAGE CODE	JEDEC LEAD (Pb)-FREE STANDARD

GLOBAL PART NUMBER											
I	H	L	P	3	2	3	2	D	Z	E R 4 R 7 M 0 1	
PRODUCT FAMILY				SIZE				PACKAGE CODE	INDUCTANCE VALUE	TOL.	SERIES



PERFORMANCE GRAPHS

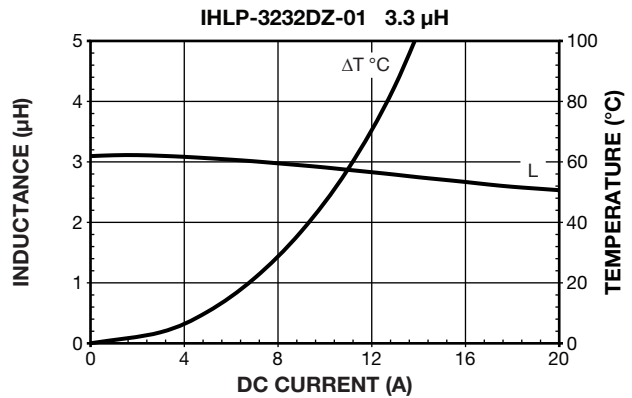
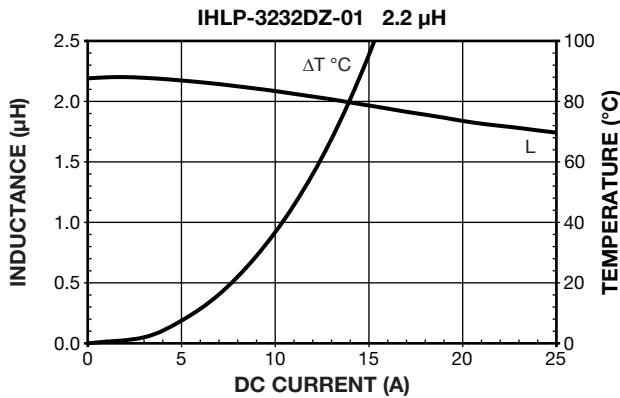
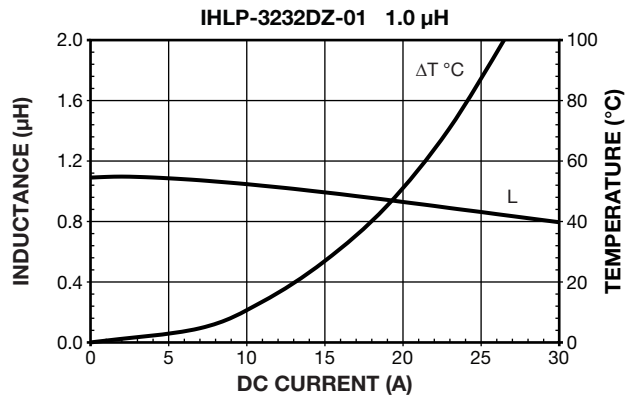
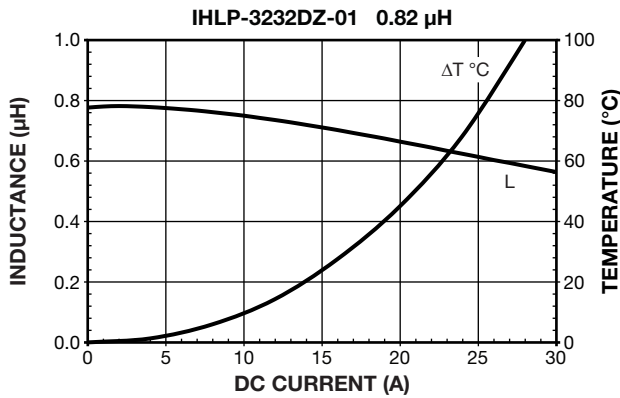
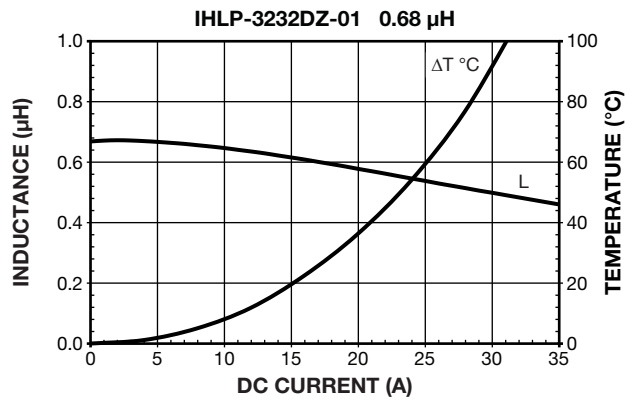
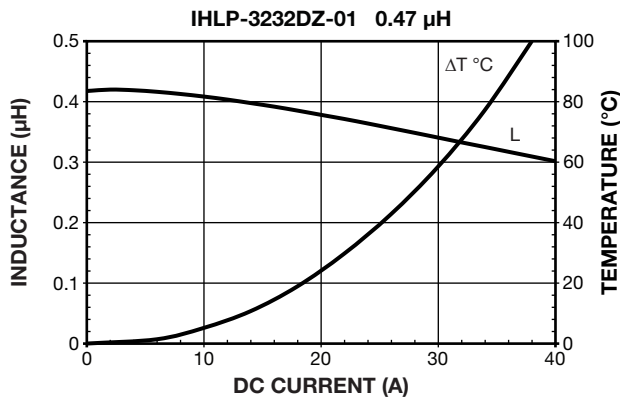
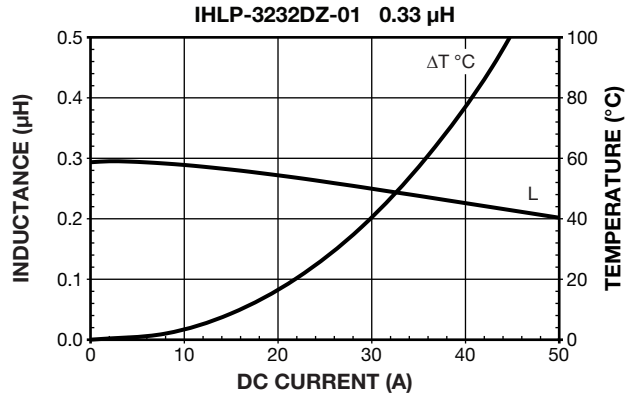
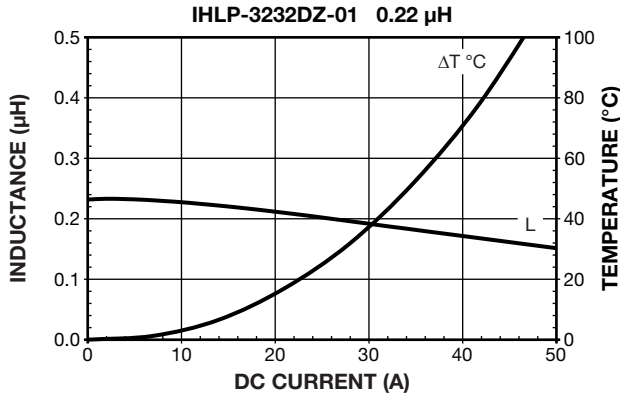



PERFORMANCE GRAPHS

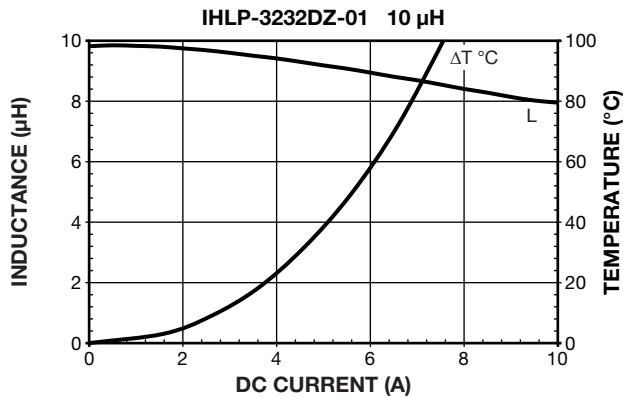
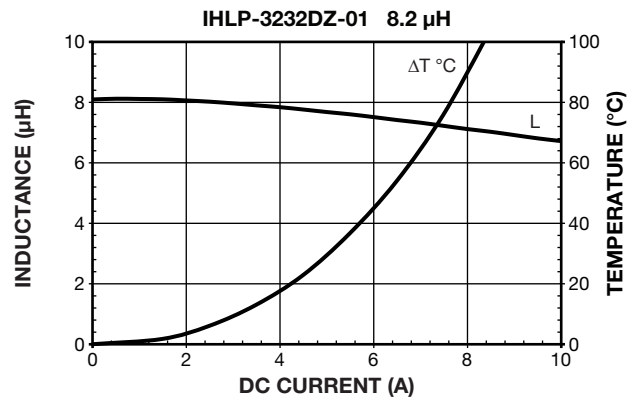
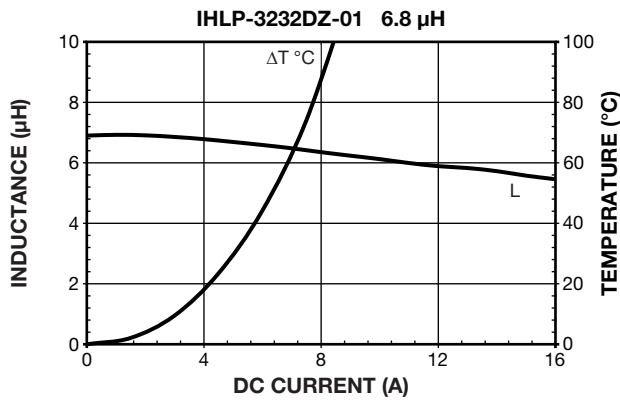
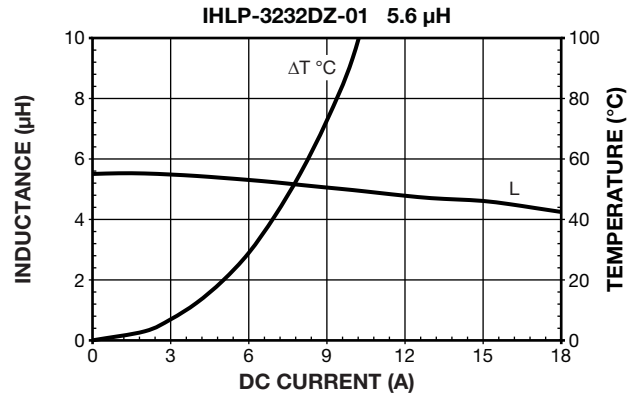
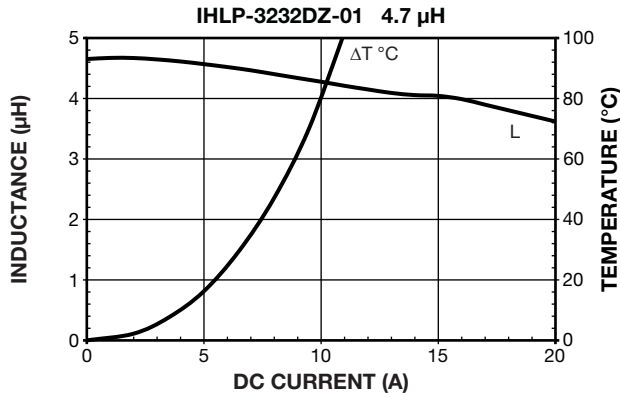



PERFORMANCE GRAPHS: INDUCTANCE AND Q VS. FREQUENCY

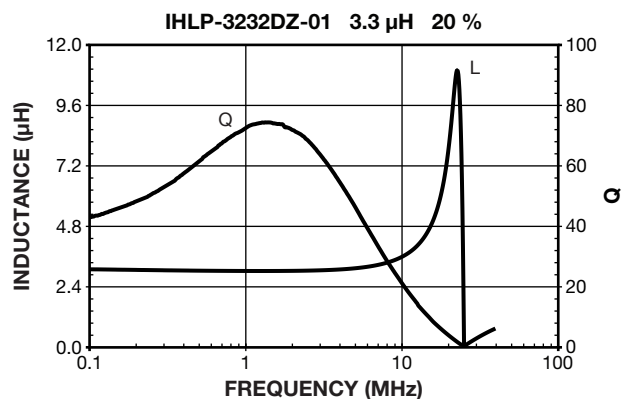
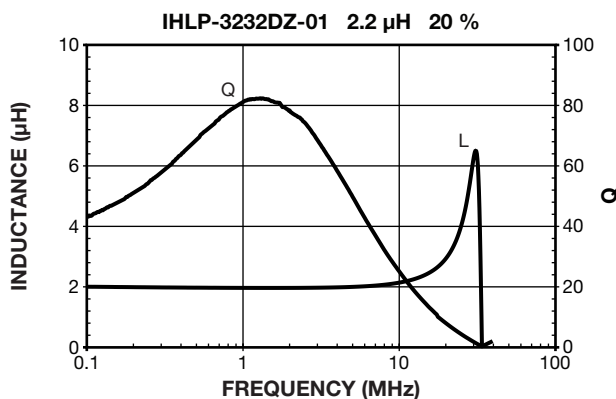
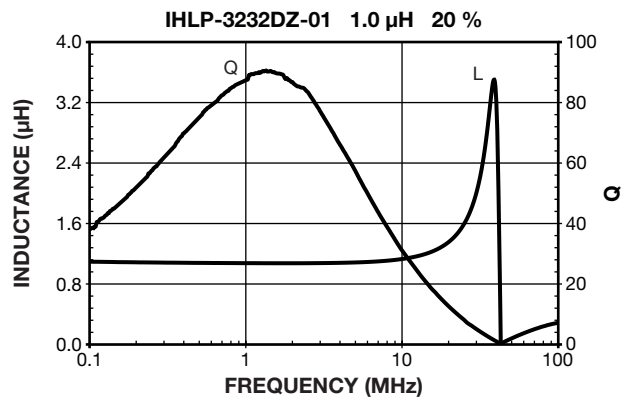
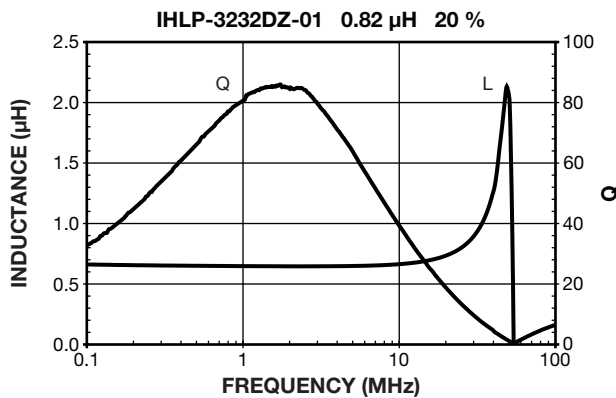
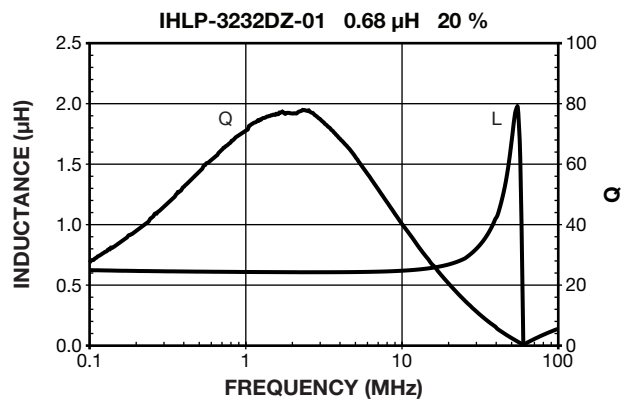
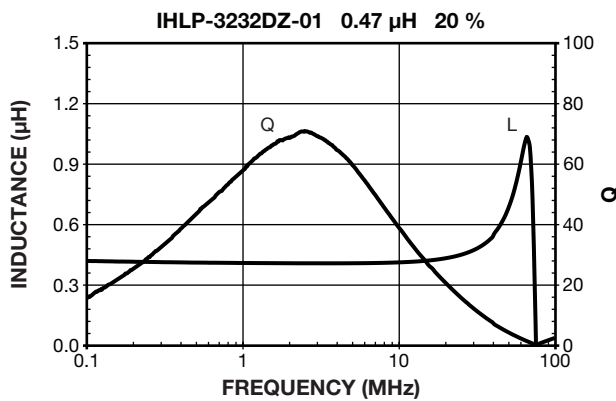
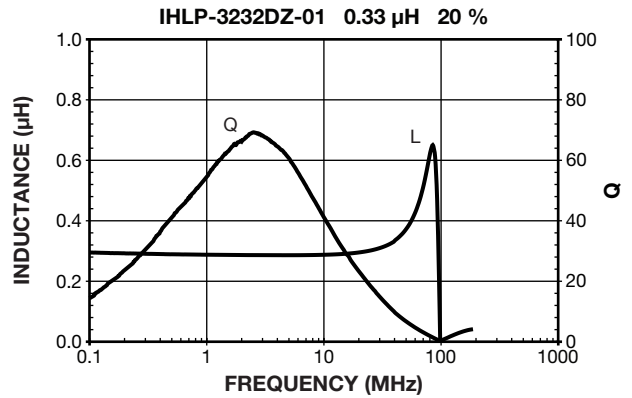
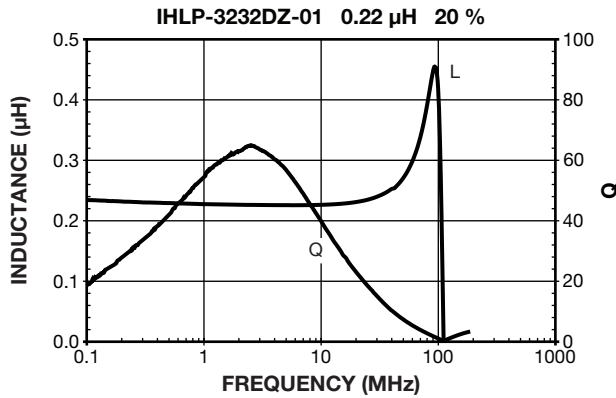

PERFORMANCE GRAPHS: INDUCTANCE AND Q VS. FREQUENCY

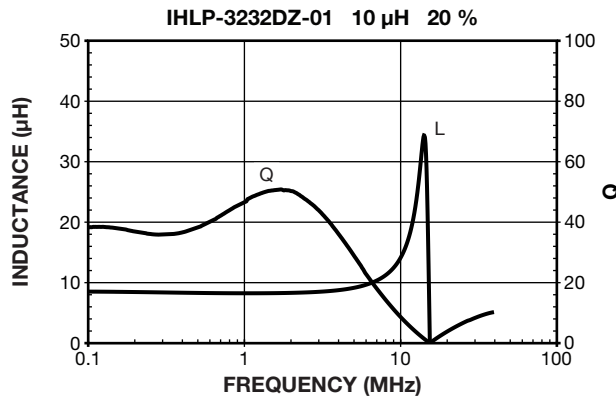
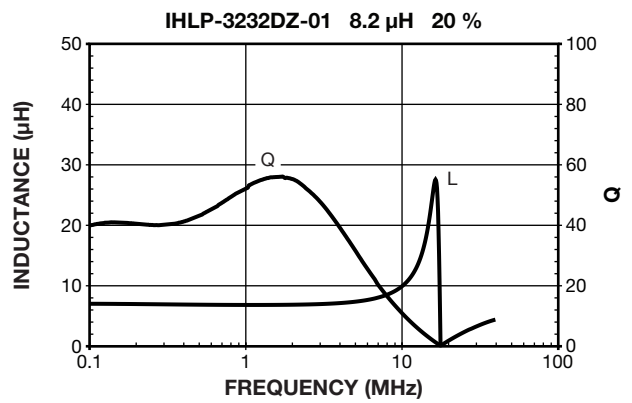
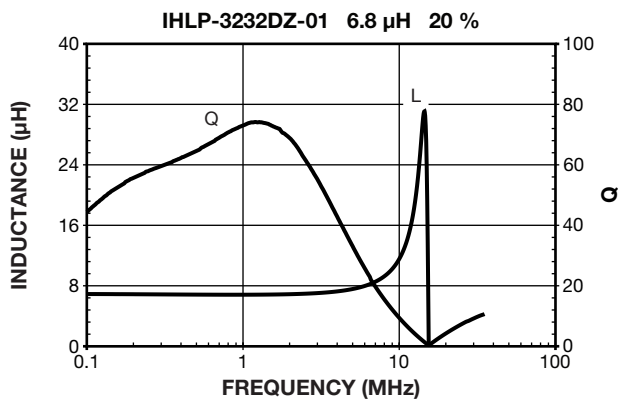
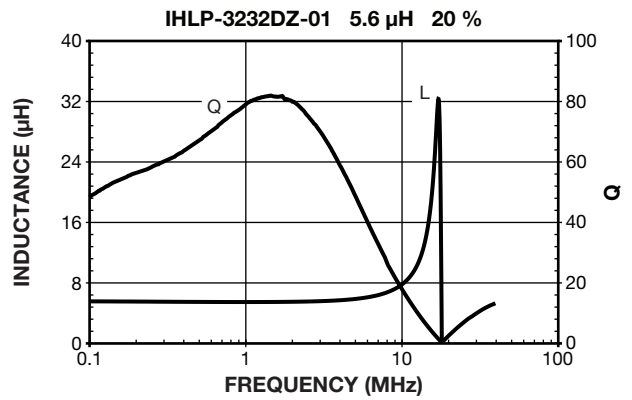
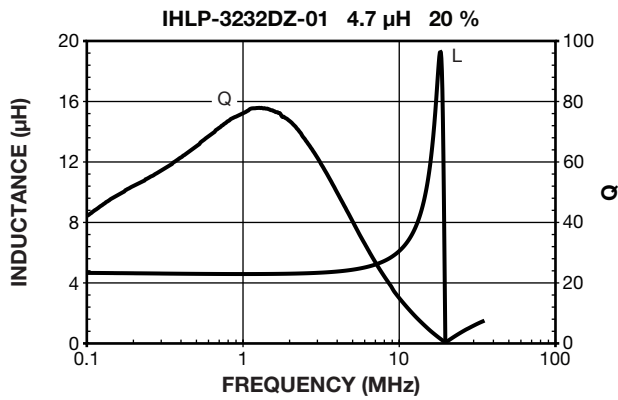

Low Profile, High Current IHLP® Inductors



Manufactured under one or more of the following:
US Patents; 6,198,375/6,204,744/6,449,829/6,460,244.
 Several foreign patents, and other patents pending.

STANDARD ELECTRICAL SPECIFICATIONS				
L_0 INDUCTANCE $\pm 20\%$ AT 100 kHz, 0.25 V, 0 A (μH)	DCR TYP. 25 °C (m Ω)	DCR MAX. 25 °C (m Ω)	HEAT RATING CURRENT DC TYP. (A) ⁽³⁾	SATURATION CURRENT DC TYP. (A) ⁽⁴⁾
0.22	1.26	1.35	34.0	22.0
0.33	2.01	2.15	27.5	16.0
0.47	2.22	2.38	25.0	14.0
0.68	3.01	3.22	22.2	14.5
0.82	3.63	3.88	19.5	15.0
1.0	4.33	4.63	18.2	12.0
2.2	8.8	9.41	14.5	10.2
3.3	14.0	14.9	10.5	9.7
4.7	21.1	22.6	8.0	8.7
5.6	26.7	28.6	7.4	7.6
6.8	31.2	33.4	7.0	6.7
8.2	42.1	45.0	5.7	6.6
10.0	48.4	51.8	5.4	6.4
15.0	61.0	65.3	4.9	3.7
22.0	88.0	94.2	4.3	3.3
33.0	135	144	3.2	3.2

Notes

- (1) All test data is referenced to 25 °C ambient
- (2) Operating temperature range - 55 °C to + 125 °C
- (3) DC current (A) that will cause an approximate ΔT of 40 °C
- (4) DC current (A) that will cause L_0 to drop approximately 20 %
- (5) The part temperature (ambient + temp. rise) should not exceed 125 °C under worst case operating conditions. Circuit design, component placement, PWB trace size and thickness, airflow and other cooling provisions all affect the part temperature. Part temperature should be verified in the end application.

FEATURES

- Shielded construction
- Frequency range up to 1.0 MHz
- Operating temperature up to 125 °C
- Lowest DCR/ μH , in this package size
- Handles high transient current spikes without saturation
- Ultra low buzz noise, due to composite construction
- Compliant to RoHS Directive 2002/95/EC

RoHS
 COMPLIANT

APPLICATIONS

- PDA/notebook/desktop/server applications
- High current POL converters
- Low profile, high current power supplies
- Battery powered devices
- DC/DC converters in distributed power systems
- DC/DC converter for Field Programmable Gate Array (FPGA)

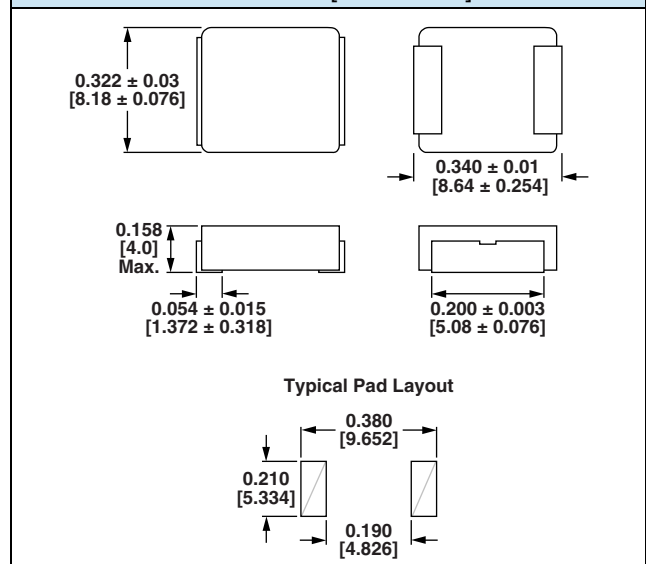
DIMENSIONS in inches [millimeters]

DESCRIPTION				
MODEL	INDUCTANCE VALUE	INDUCTANCE TOLERANCE	PACKAGE CODE	JEDEC LEAD (Pb)-FREE STANDARD
IHLP-3232DZ-11	33 μH	$\pm 20\%$	ER	e3

GLOBAL PART NUMBER																	
I	H	L	P	3	2	3	2	D	Z	E	R	3	3	0	M	1	1
PRODUCT FAMILY				SIZE				PACKAGE CODE		INDUCTANCE VALUE			TOL.	SERIES			



PERFORMANCE GRAPHS

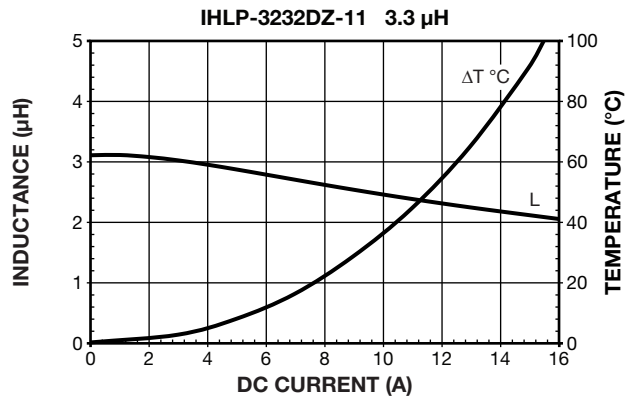
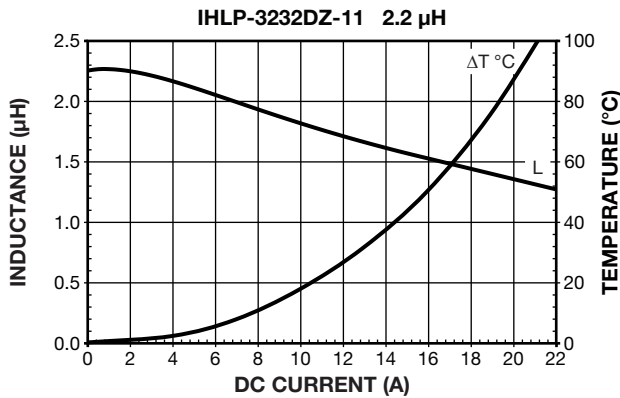
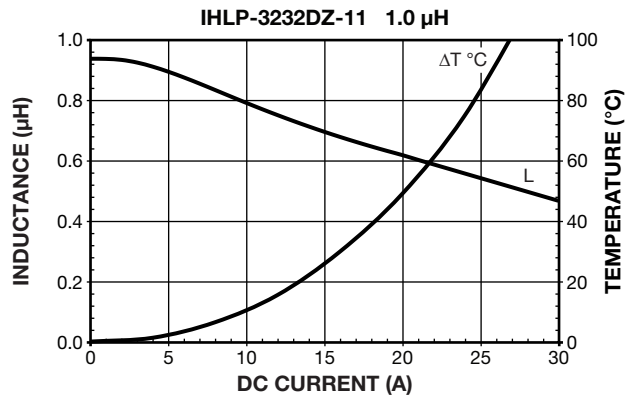
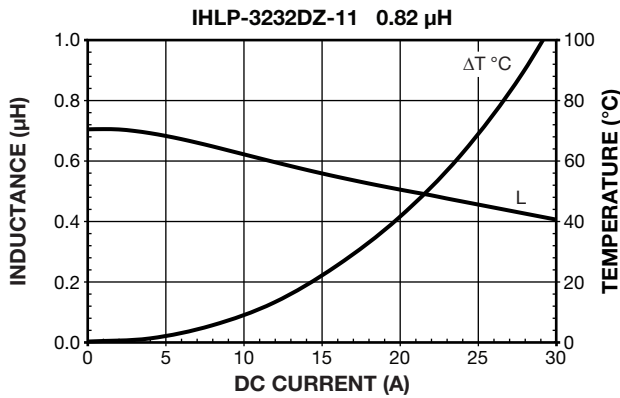
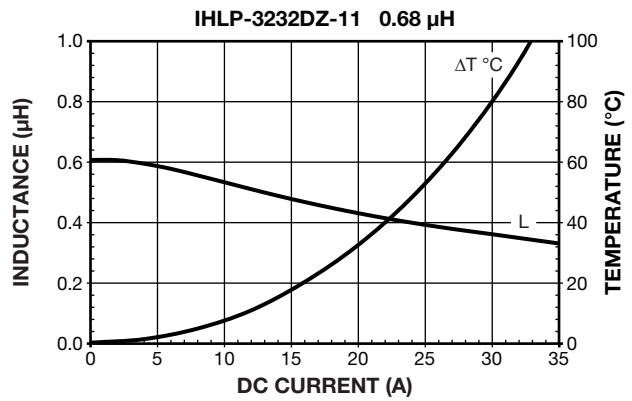
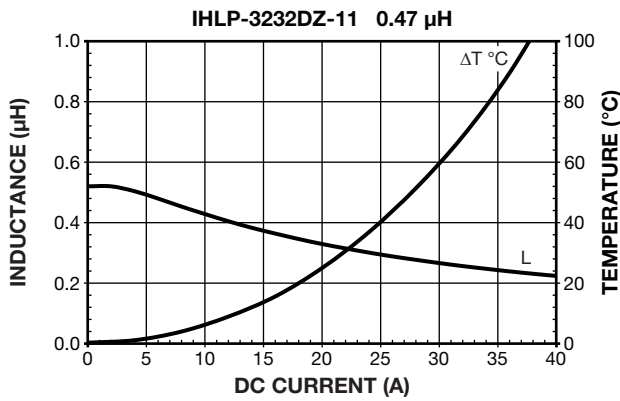
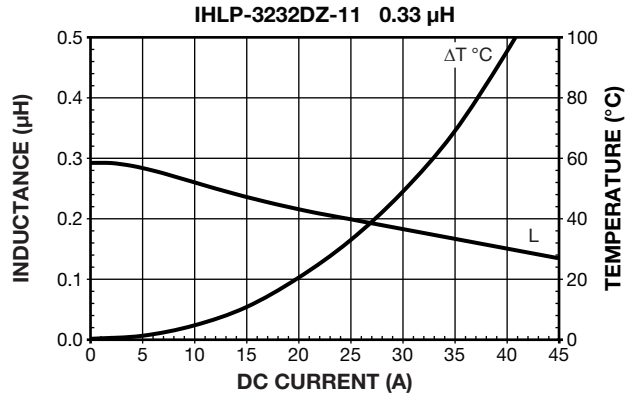
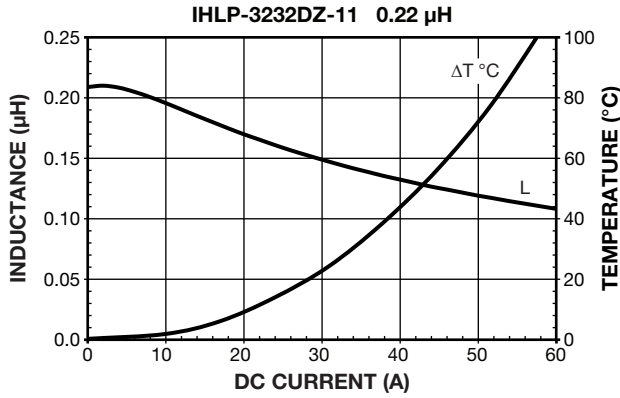



PERFORMANCE GRAPHS

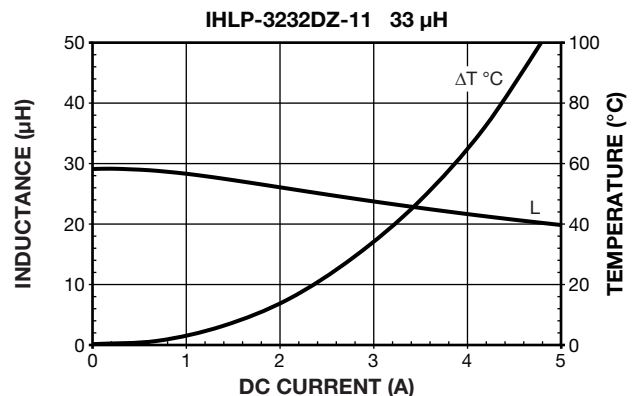
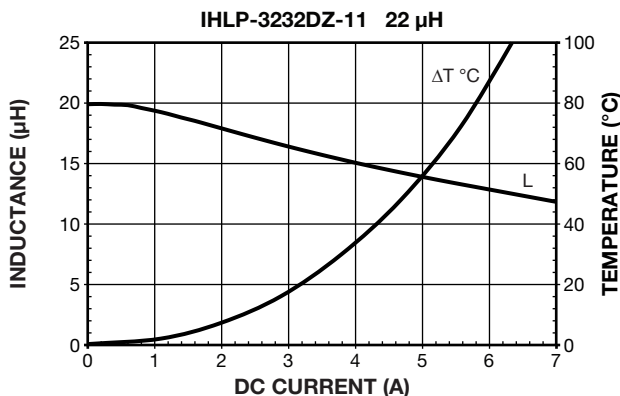
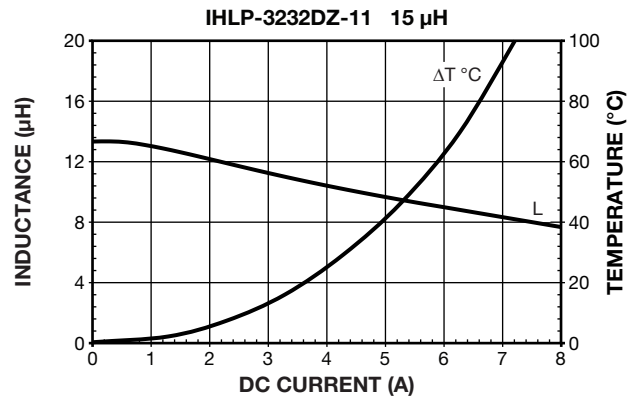
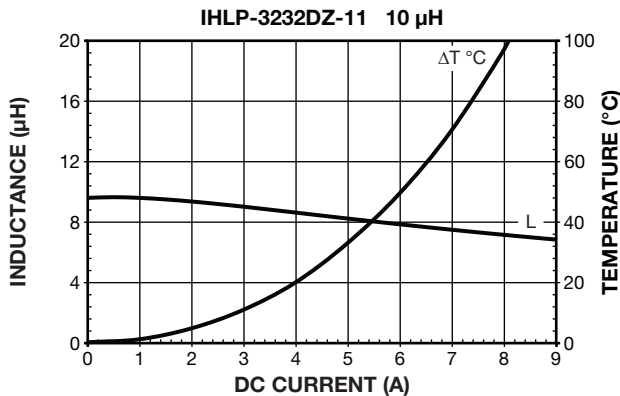
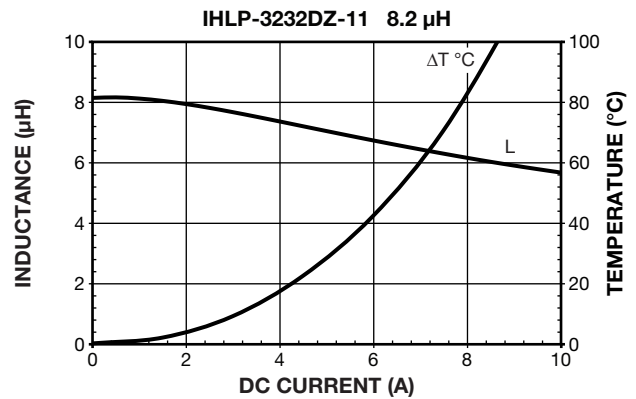
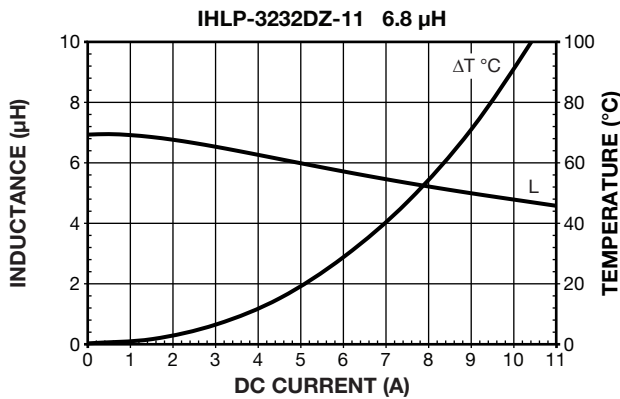
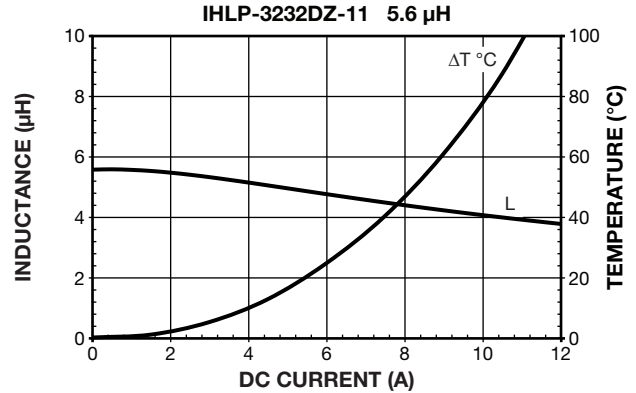
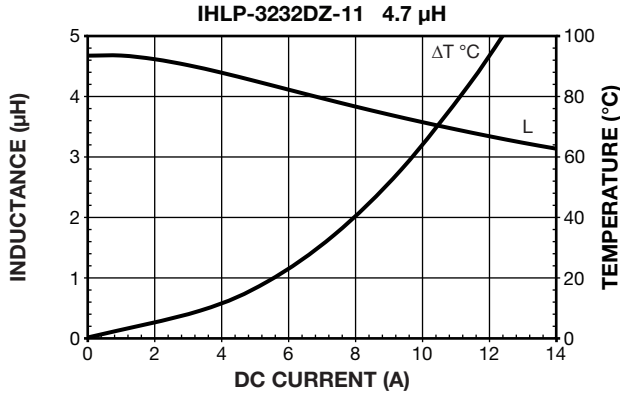



PERFORMANCE GRAPHS: INDUCTANCE AND Q VS. FREQUENCY

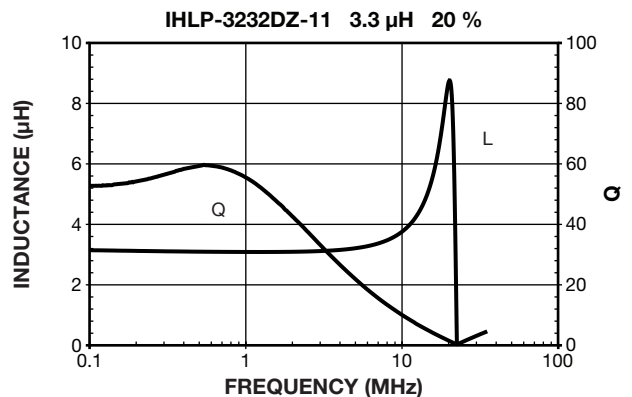
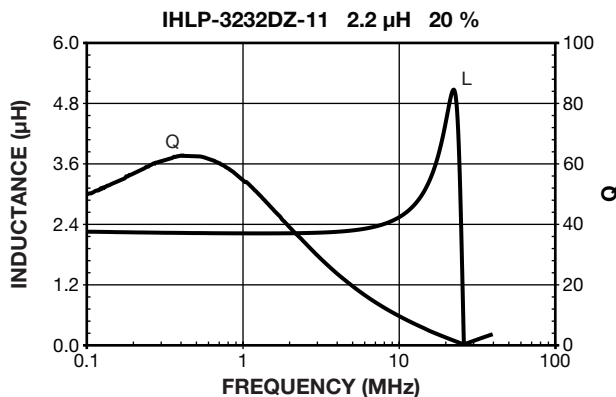
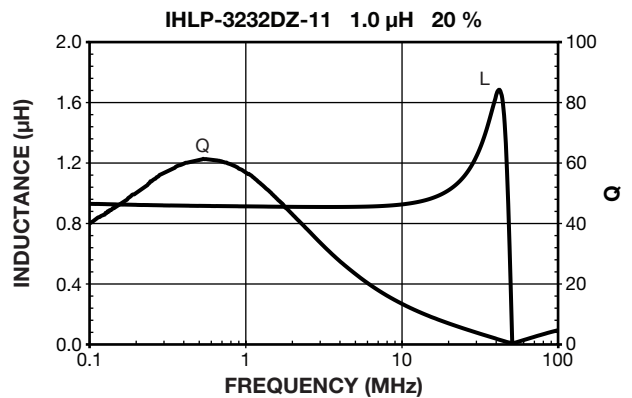
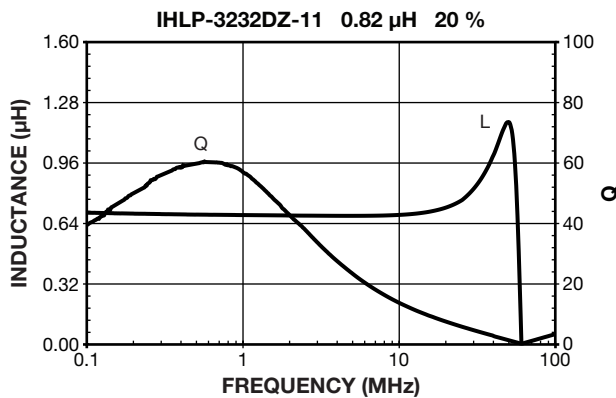
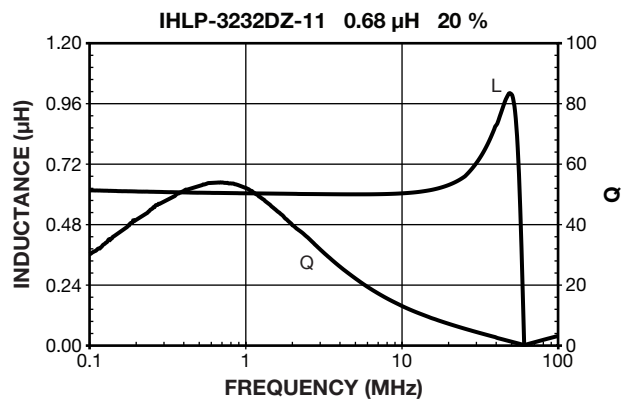
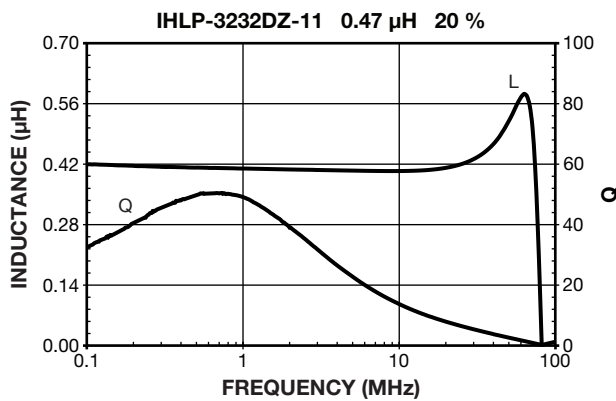
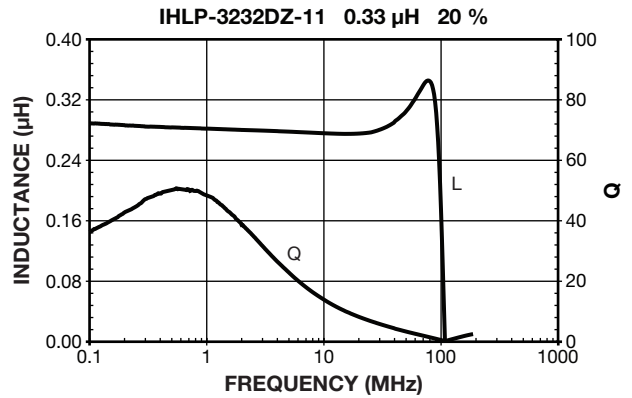
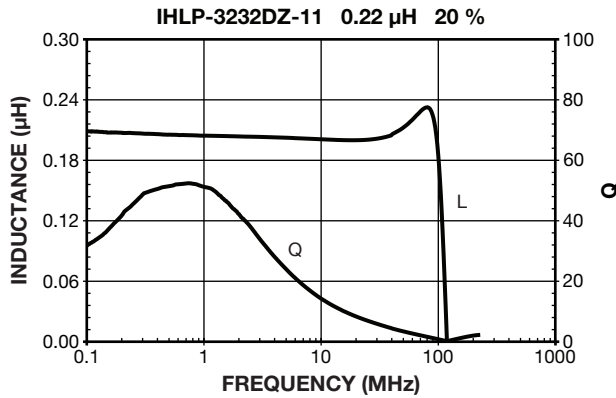



PERFORMANCE GRAPHS: INDUCTANCE AND Q VS. FREQUENCY

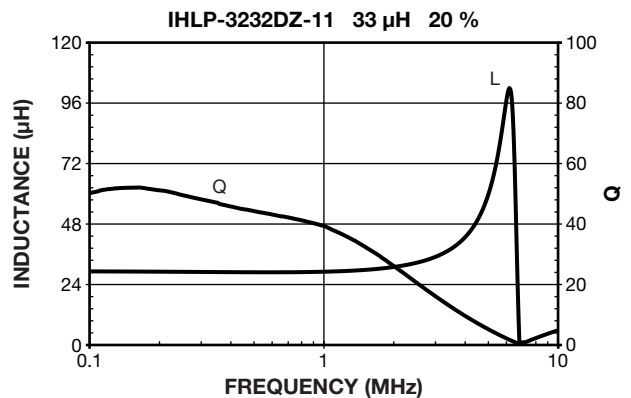
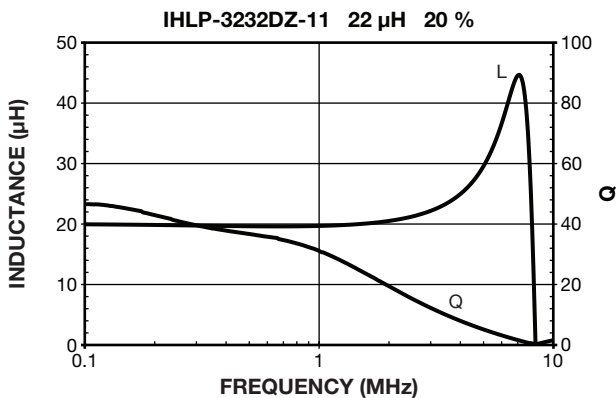
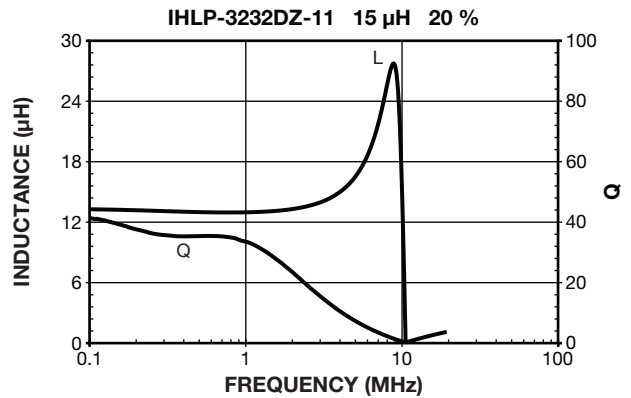
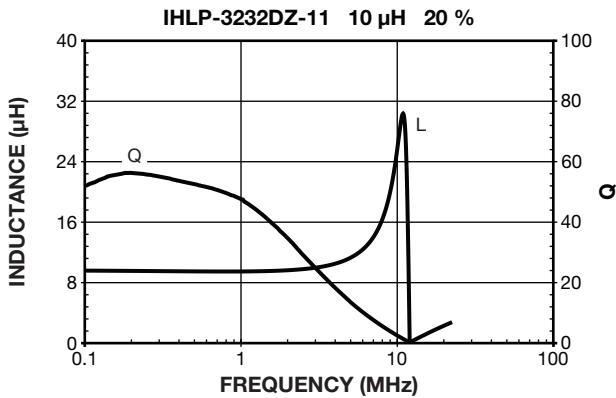
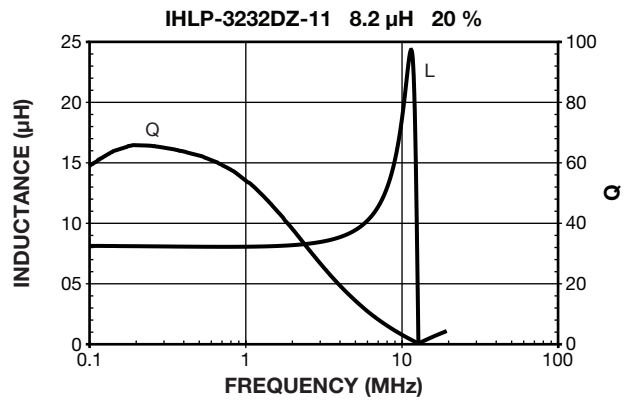
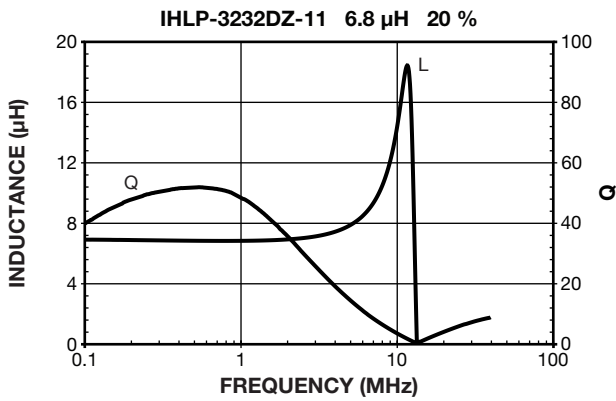
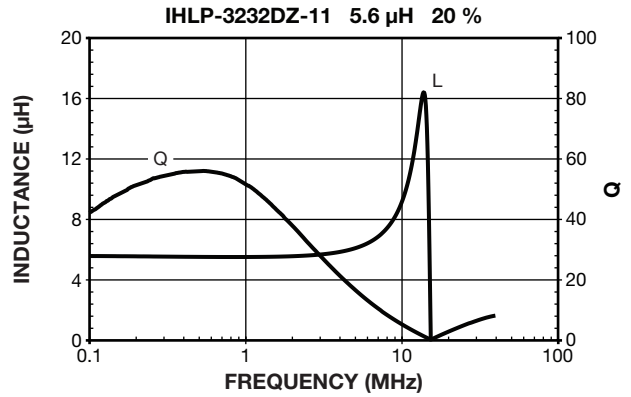
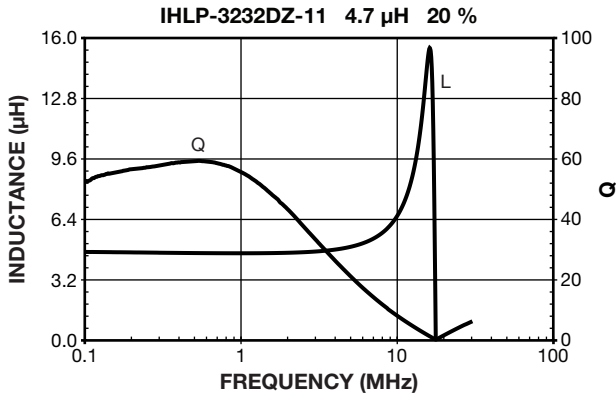

Low Profile, High Current IHLP® Inductors



Manufactured under one or more of the following:
US Patents; 6,198,375/6,204,744/6,449,829/6,460,244.
 Several foreign patents, and other patents pending.

STANDARD ELECTRICAL SPECIFICATIONS				
L_0 INDUCTANCE $\pm 20\%$ AT 100 kHz, 0.25 V, 0 A (μH)	DCR TYP. 25 °C (m Ω)	DCR MAX. 25 °C (m Ω)	HEAT RATING CURRENT DC TYP. (A) ⁽³⁾	SATURATION CURRENT DC TYP. (A) ⁽⁴⁾
0.19	0.875	0.95	40.0	90.0
0.36	1.30	1.40	31.5	60.0
0.56	1.70	1.80	27.5	49.0
1.0	3.70	4.10	17.5	36.0
1.5	5.30	5.80	15.0	27.5
2.2	8.20	9.00	12.0	25.6
3.3	13.70	14.40	10.0	18.6
4.7	15.00	16.50	9.5	17.0
5.6	17.60	19.30	8.5	16.0
6.8	21.20	23.30	8.0	13.5
10	33.20	36.50	6.8	12.0

Notes

- (1) All test data is referenced to 25 °C ambient
- (2) Operating temperature range - 55 °C to + 125 °C
- (3) DC current (A) that will cause an approximate ΔT of 40 °C
- (4) DC current (A) that will cause L_0 to drop approximately 20 %
- (5) The part temperature (ambient + temp. rise) should not exceed 125 °C under worst case operating conditions. Circuit design, component placement, PWB trace size and thickness, airflow and other cooling provisions all affect the part temperature. Part temperature should be verified in the end application.

FEATURES

- Shielded construction
- Frequency range up to 5.0 MHz
- Lowest DCR/ μH , in this package size
- Handles high transient current spikes without saturation
- Ultra low buzz noise, due to composite construction
- Compliant to RoHS Directive 2002/95/EC



RoHS
COMPLIANT

GREEN
(5-2008)**

APPLICATIONS

- PDA/notebook/desktop/server applications
- High current POL converters
- Low profile, high current power supplies
- Battery powered devices
- DC/DC converters in distributed power systems
- DC/DC converter for Field Programmable Gate Array (FPGA)

DIMENSIONS in inches [millimeters]

Typical Pad Layout

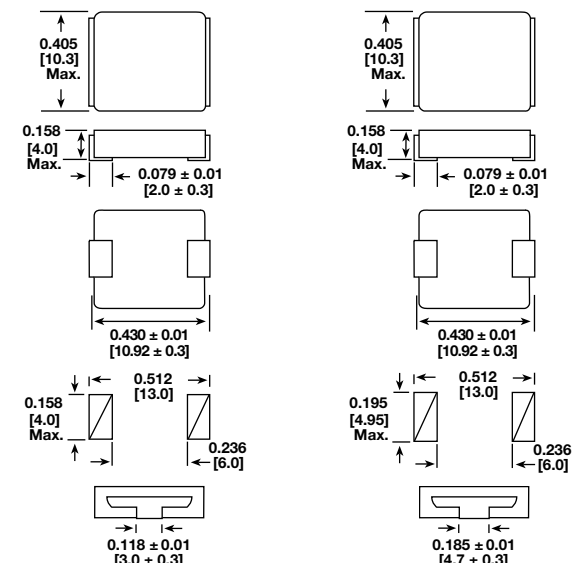

The diagram above applies to values
1.0 μH and above.

The diagram above applies to values
0.56 μH and below.

DESCRIPTION

IHLP-4040DZ-01	6.8 μH	$\pm 20\%$	ER	e3
MODEL	INDUCTANCE VALUE	INDUCTANCE TOLERANCE	PACKAGE CODE	JEDEC LEAD (Pb)-FREE STANDARD

GLOBAL PART NUMBER

I	H	L	P	4	0	4	0	D	Z	E	R	6	R	8	M	0	1
PRODUCT FAMILY				SIZE				PACKAGE CODE		INDUCTANCE VALUE			TOL.		SERIES		

** Please see document "Vishay Material Category Policy": www.vishay.com/doc?99902

PERFORMANCE GRAPHS

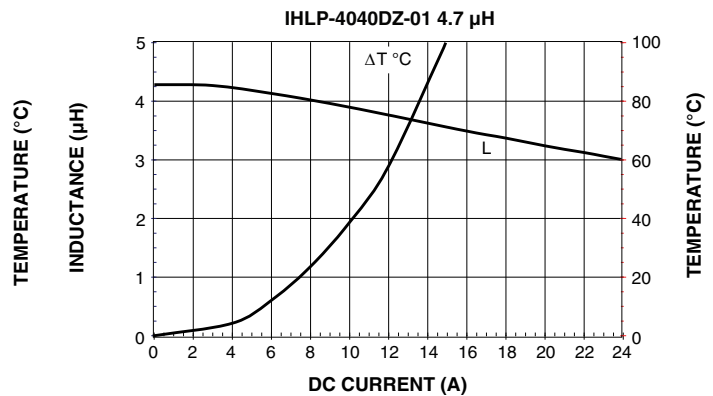
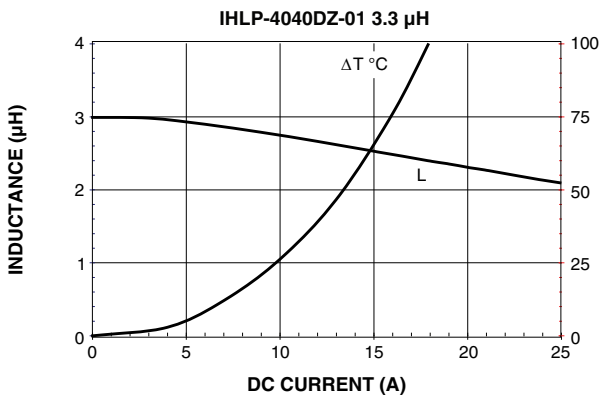
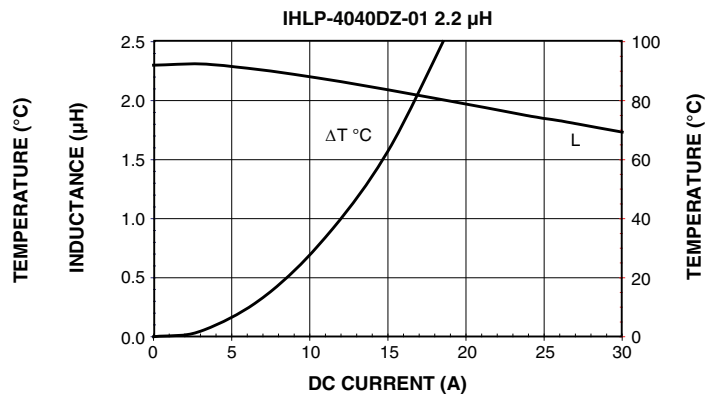
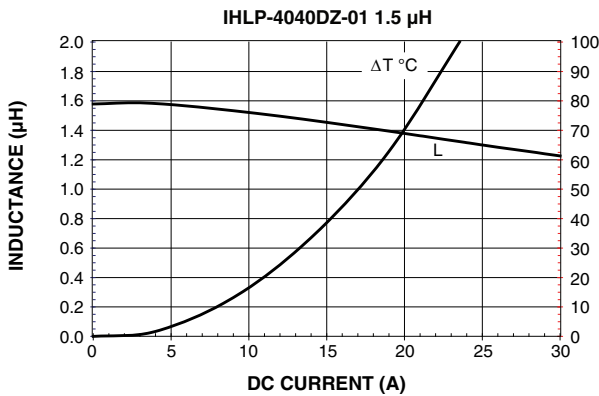
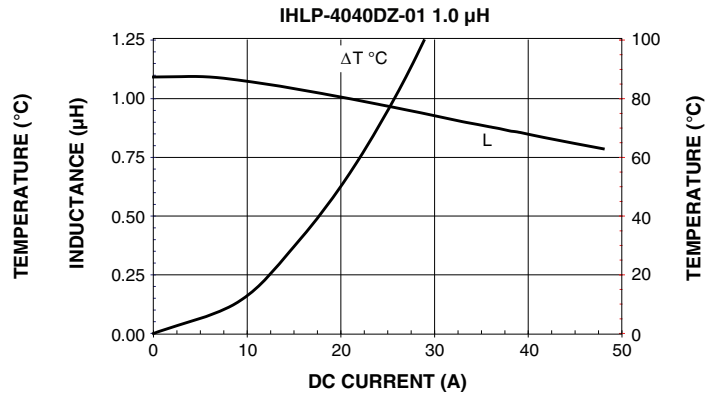
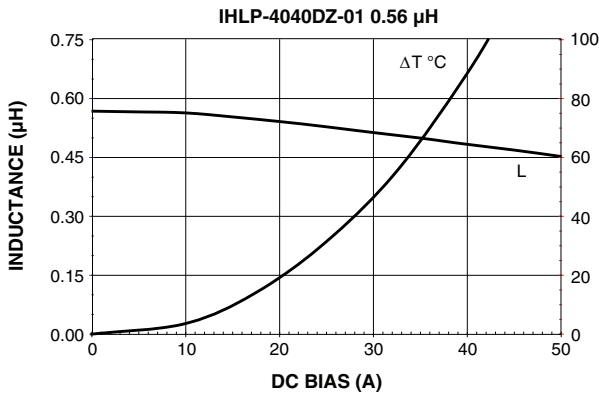
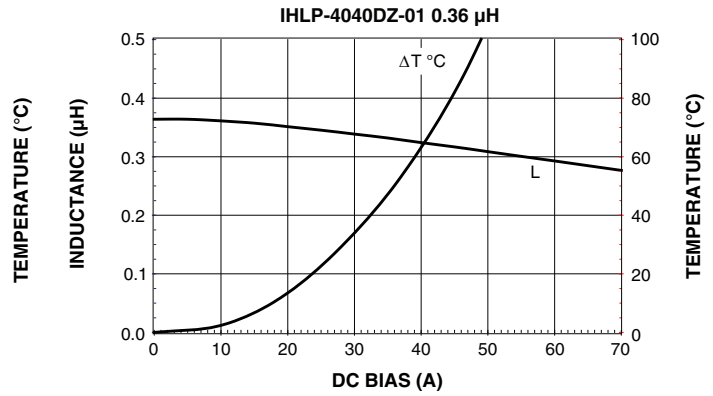
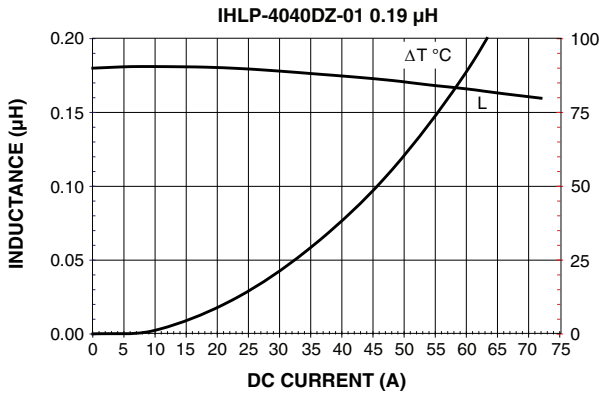



PERFORMANCE GRAPHS

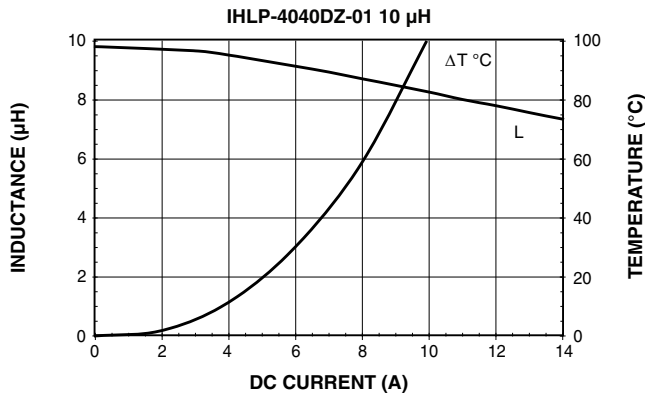
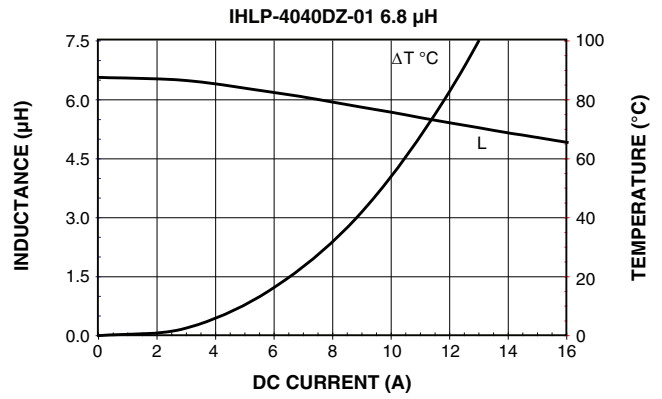
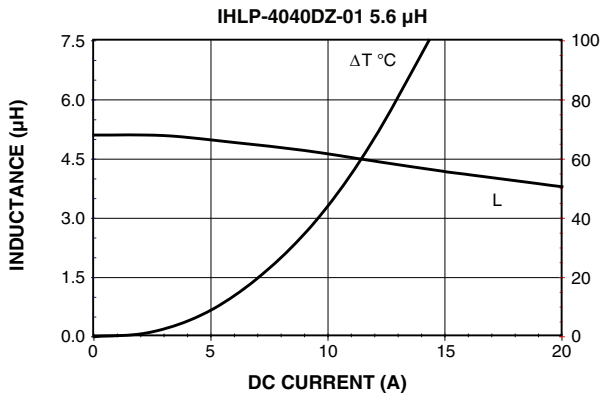

Low Profile, High Current IHLP® Inductors

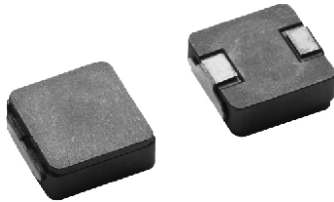

Manufactured under one or more of the following:
US Patents; 6,198,375/6,204,744/6,449,829/6,460,244.
 Several foreign patents, and other patents pending.



RoHS
 COMPLIANT
 HALOGEN
FREE

FEATURES

- Shielded construction
- Frequency range up to 1.0 MHz
- Lowest DCR/ μ H, in this package size
- Handles high transient current spikes without saturation
- Ultra low buzz noise, due to composite construction
- Excellent temperature stability for inductance and saturation
- Compliant to RoHS Directive 2002/95/EC
- Halogen-free according to IEC 61249-2-21 definition

APPLICATIONS

- PDA/notebook/desktop/server applications
- High current POL converters
- Low profile, high current power supplies
- Battery powered devices
- DC/DC converters in distributed power systems
- DC/DC converter for Field Programmable Gate Array (FPGA)

STANDARD ELECTRICAL SPECIFICATIONS				
L_0 INDUCTANCE $\pm 20\%$ AT 100 kHz, 0.25 V, 0 A (μ H)	DCR TYP. 25 °C (m Ω)	DCR MAX. 25 °C (m Ω)	HEAT RATING CURRENT DC TYP. (A) ⁽³⁾	SATURATION CURRENT DC TYP. (A) ⁽⁴⁾
0.19	0.70	0.80	40	46
0.22	0.85	0.95	33	44
0.24	0.85	0.95	33	44
0.36	1.05	1.15	32	30
0.47	1.53	1.68	30	30
0.56	1.61	1.80	32	22
0.78	1.80	1.90	27	22
1.0	2.30	2.50	25	20
1.8	4.50	5.00	17	16
2.0	5.20	5.80	16	14
4.7	12.9	14.2	9.5	7.6
6.8	17.5	19.3	9.0	7.5
10.0	27.8	30.5	7.5	7.1
15.0	40.9	45.0	6.25	6.0
22.0	60.4	66.0	5.0	4.5
33.0	87.5	94.5	4.4	4.0
47.0	132.0	145.0	3.3	3.0
100.0	249.0	270.0	2.5	2.25

Notes

- (1) All test data is referenced to 25 °C ambient
- (2) Operating temperature range - 55 °C to + 125 °C
- (3) DC current (A) that will cause an approximate ΔT of 40 °C
- (4) DC current (A) that will cause L_0 to drop approximately 20 %
- (5) The part temperature (ambient + temp. rise) should not exceed 125 °C under worst case operating conditions. Circuit design, component placement, PWB trace size and thickness, airflow and other cooling provisions all affect the part temperature. Part temperature should be verified in the end application.

DIMENSIONS in inches [millimeters]

Typical Pad Layout

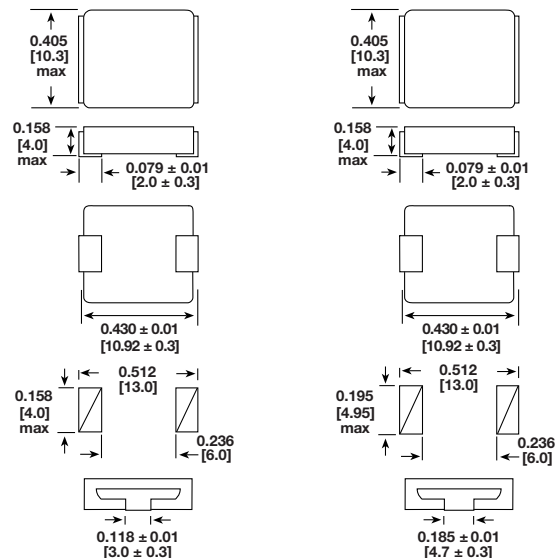

DESCRIPTION					
IHLP-4040DZ-11	2.0 μ H	$\pm 20\%$	ER	e3	
MODEL	INDUCTANCE VALUE	INDUCTANCE TOLERANCE	PACKAGE CODE	JEDEC LEAD (Pb)-FREE STANDARD	

GLOBAL PART NUMBER																	
I	H	L	P	4	0	4	0	D	Z	E	R	2	R	0	M	1	1
PRODUCT FAMILY				SIZE				PACKAGE CODE		INDUCTANCE VALUE			TOL.	SERIES			



PERFORMANCE GRAPHS

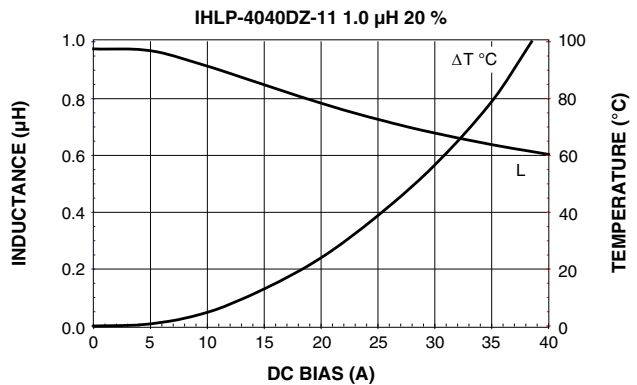
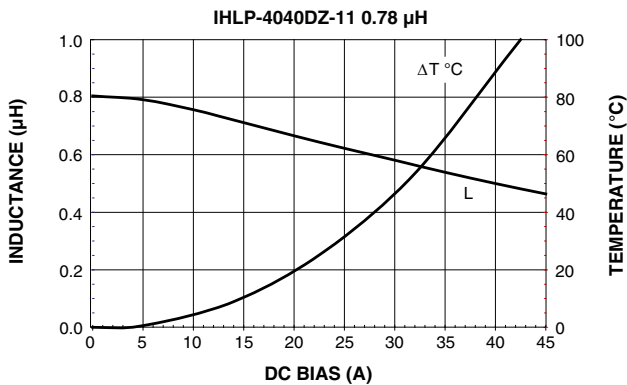
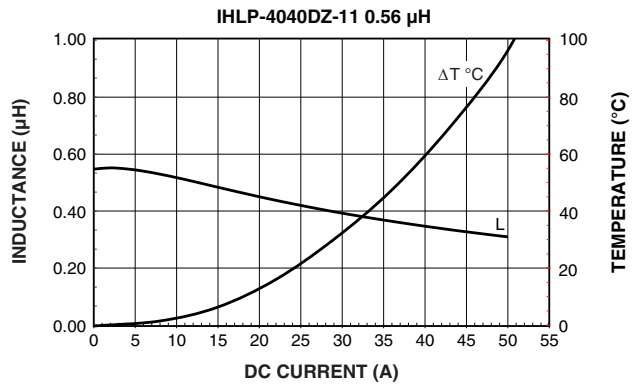
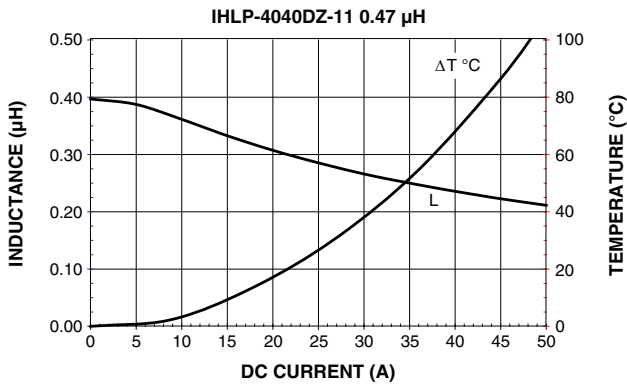
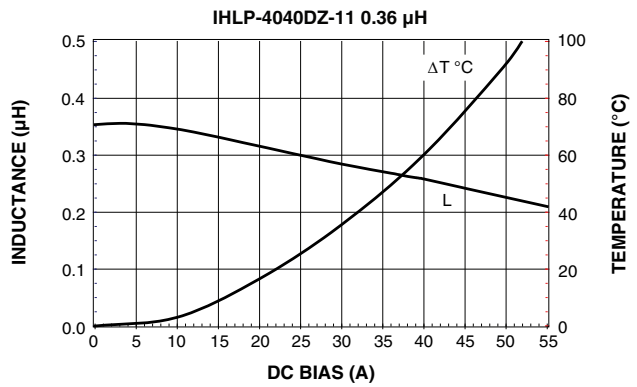
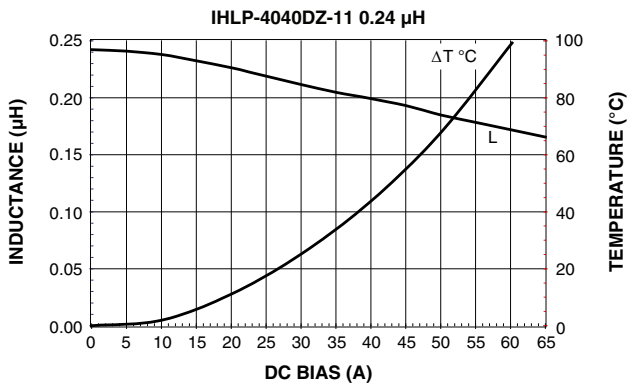
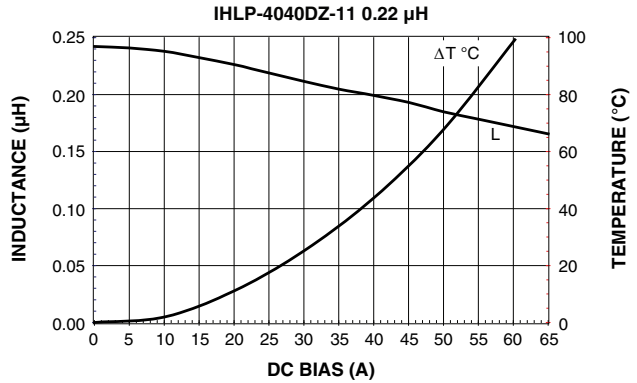
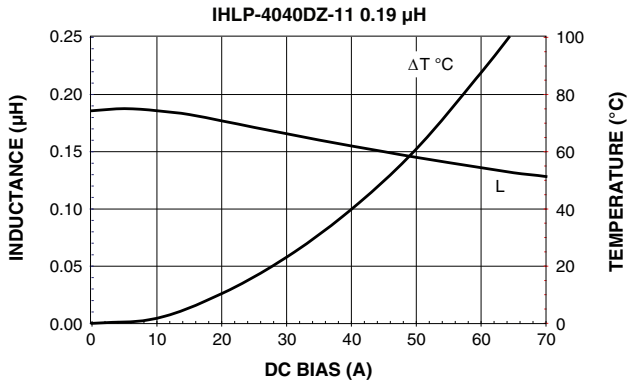



PERFORMANCE GRAPHS

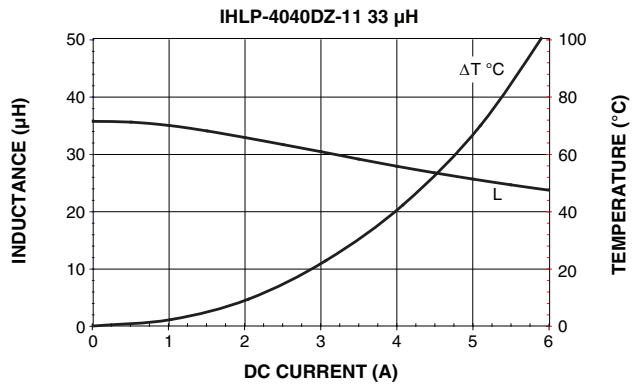
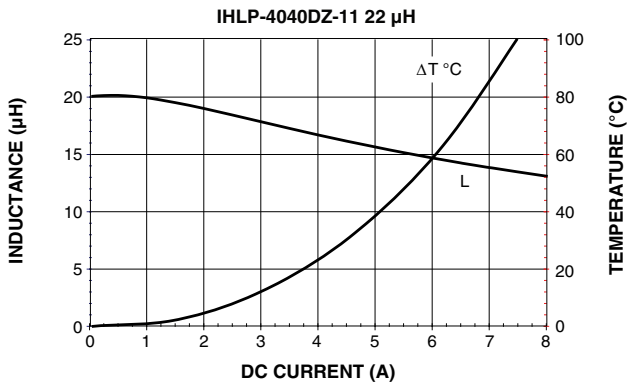
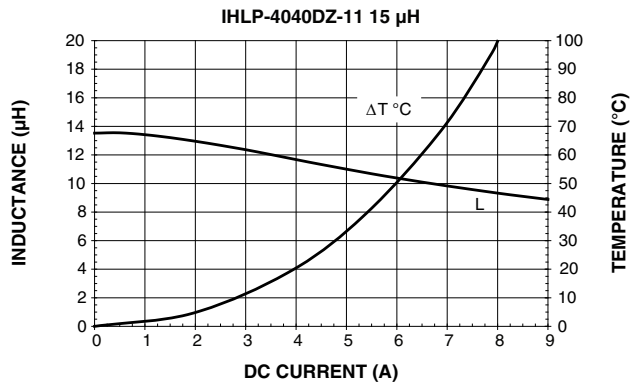
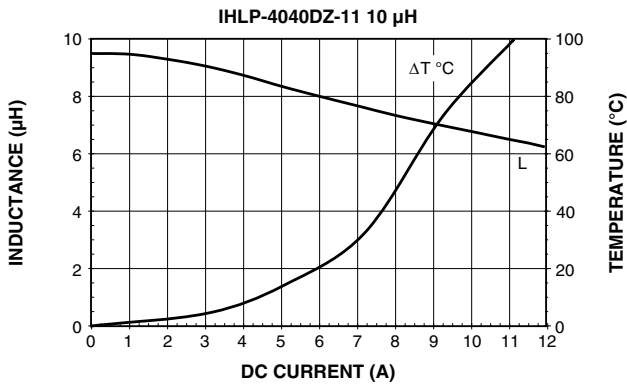
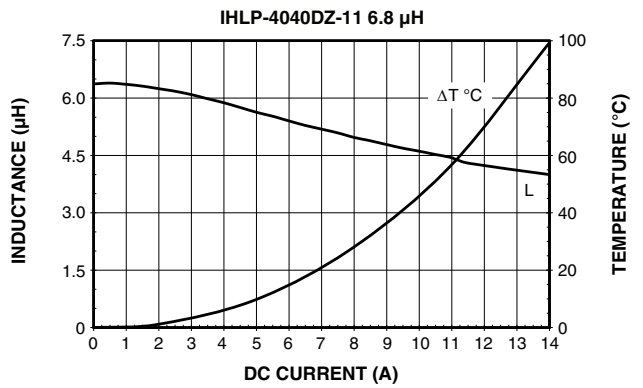
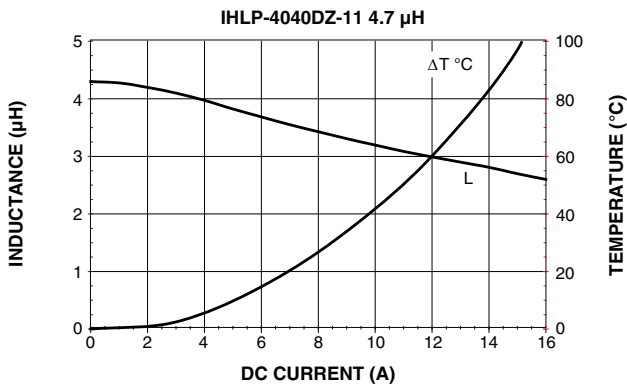
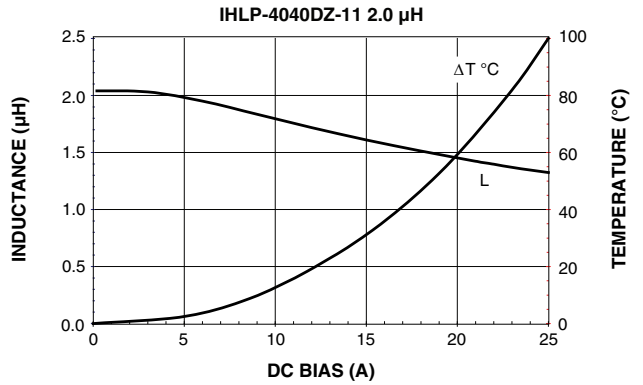
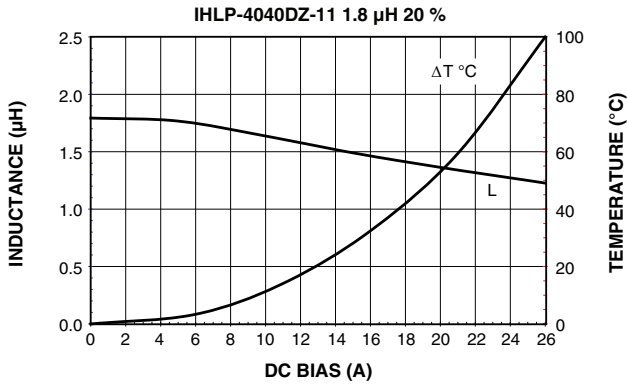



PERFORMANCE GRAPHS

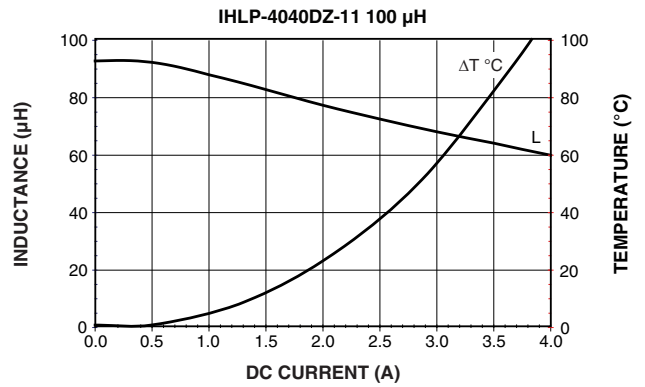
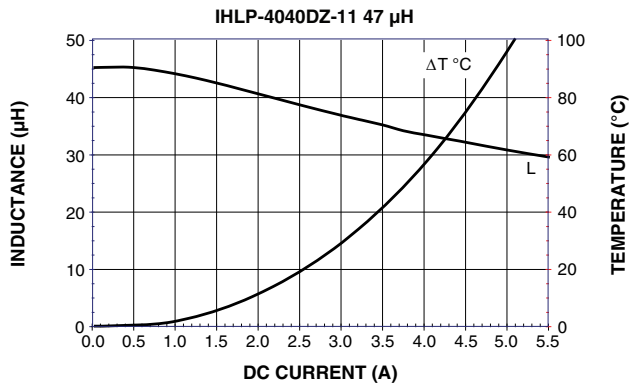

Low Profile, High Current IHLP® Inductors



Manufactured under one or more of the following:
US Patents; 6,198,375/6,204,744/6,449,829/6,460,244.
 Several foreign patents, and other patents pending.

STANDARD ELECTRICAL SPECIFICATIONS				
L_0 INDUCTANCE ± 20 % AT 100 kHz, 0.25 V, 0 A (μH)	DCR TYP. 25 °C (m Ω)	DCR MAX. 25 °C (m Ω)	HEAT RATING CURRENT DC TYP. (A) ⁽³⁾	SATURATION CURRENT DC TYP. (A) ⁽⁴⁾
0.10	0.8	0.96	43	84
0.15	1	1.2	41	75
0.22	1.1	1.3	38.5	65
0.33	1.3	1.5	36.5	62
0.47	1.6	2	32	55
0.60	1.8	2.2	29	51
0.68	2.3	2.5	28	49
0.82	2.6	3	25	44
1.0	3.3	3.5	24	40
1.5	5.1	5.5	19	35
1.8	6.5	7	16.5	30
2.2	7.2	8	16	29
3.3	11	12	12	27
4.7	14.3	15	10	24
5.6	18.3	19	9.5	19
6.8	19.8	22	9	18
8.2	24.8	28	8.5	16
10	30.4	34	7	14

Notes

- (1) All test data is referenced to 25 °C ambient
- (2) Operating temperature range - 55 °C to + 125 °C
- (3) DC current (A) that will cause an approximate ΔT of 40 °C
- (4) DC current (A) that will cause L_0 to drop approximately 20 %
- (5) The part temperature (ambient + temp. rise) should not exceed 125 °C under worst case operating conditions. Circuit design, component placement, PWB trace size and thickness, airflow and other cooling provisions all affect the part temperature. Part temperature should be verified in the end application.

FEATURES

- Lowest height (3.5 mm) in this package footprint
- Shielded construction
- Frequency range up to 5.0 MHz
- Lowest DCR/ μH , in this package size
- Handles high transient current spikes without saturation
- Ultra low buzz noise, due to composite construction
- Compliant to RoHS Directive 2002/95/EC



RoHS
 COMPLIANT
GREEN
 (5-2008)**

APPLICATIONS

- PDA/notebook/desktop/server applications
- High current POL converters
- Low profile, high current power supplies
- Battery powered devices
- DC/DC converters in distributed power systems
- DC/DC converter for Field Programmable Gate Array (FPGA)

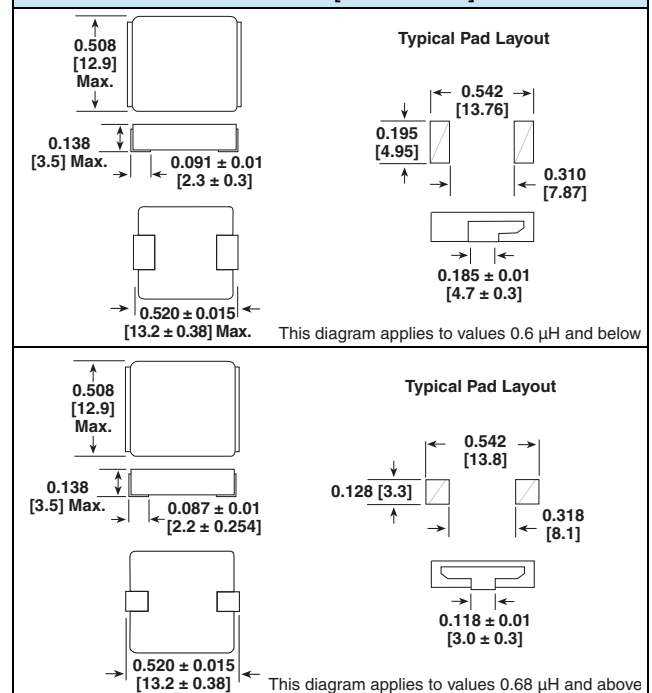
DIMENSIONS in inches [millimeters]

DESCRIPTION

IHLP-5050CE-01	1.0 μH	± 20 %	ER	e3
MODEL	INDUCTANCE VALUE	INDUCTANCE TOLERANCE	PACKAGE CODE	JEDEC LEAD (Pb)-FREE STANDARD

GLOBAL PART NUMBER

I	H	L	P	5	0	5	0	C	E	E	R	1	R	0	M	0	1
PRODUCT FAMILY				SIZE				PACKAGE CODE		INDUCTANCE VALUE		TOL.	SERIES				

** Please see document "Vishay Material Category Policy": www.vishay.com/doc?99902

PERFORMANCE GRAPHS

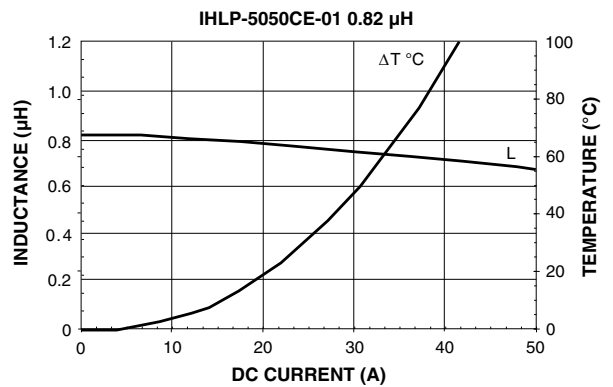
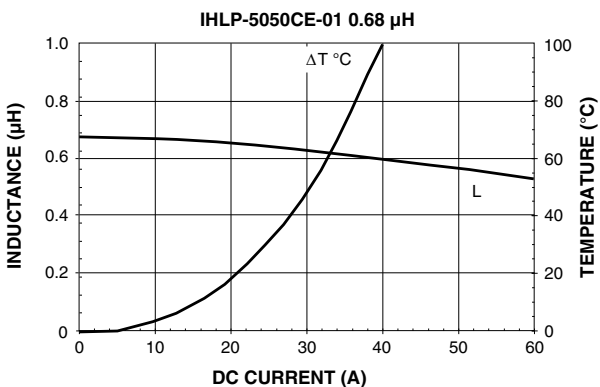
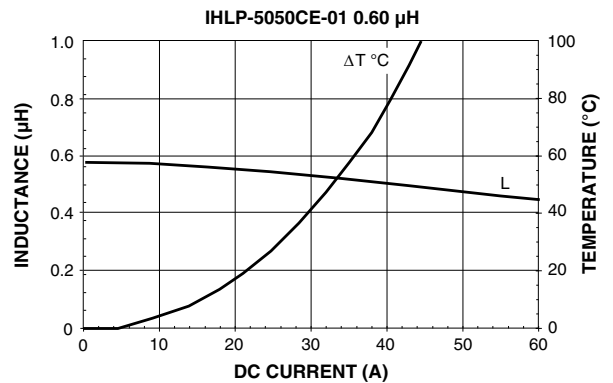
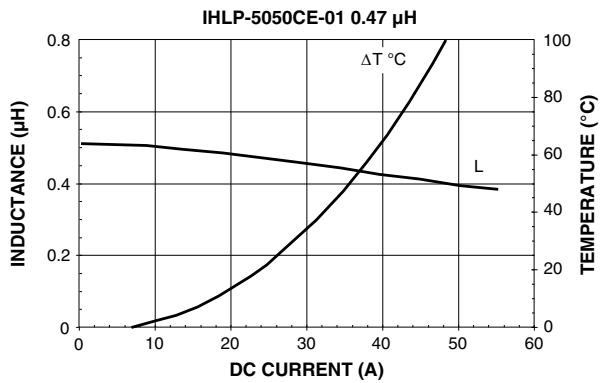
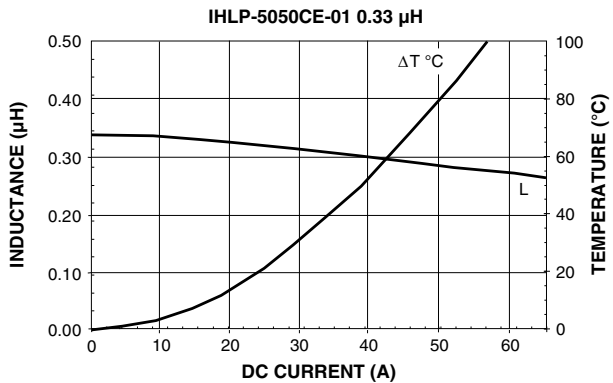
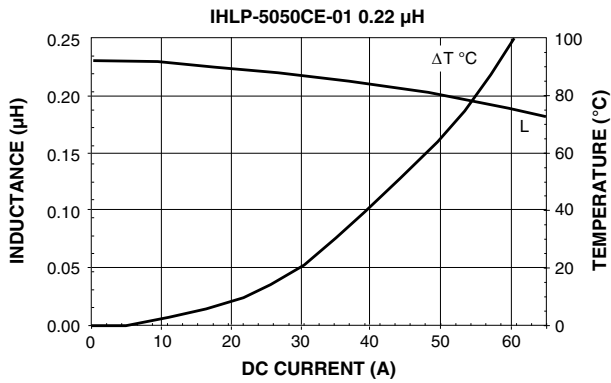
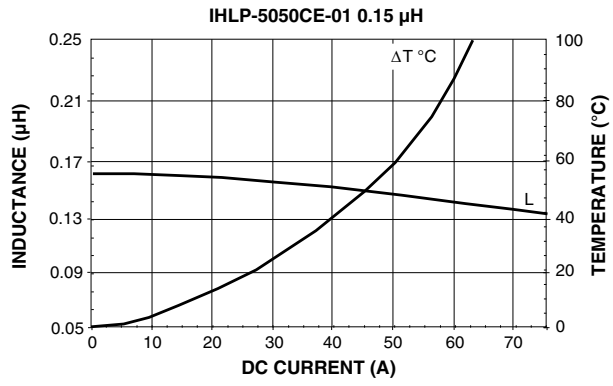
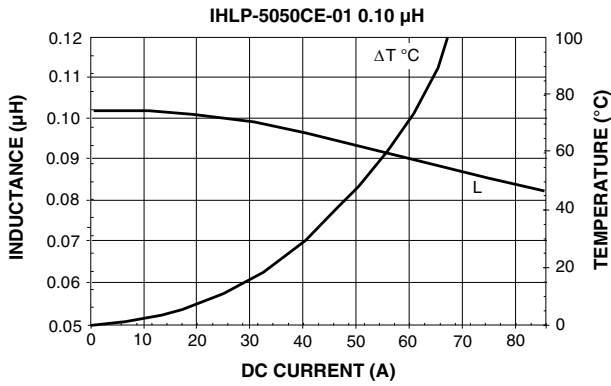

PERFORMANCE GRAPHS

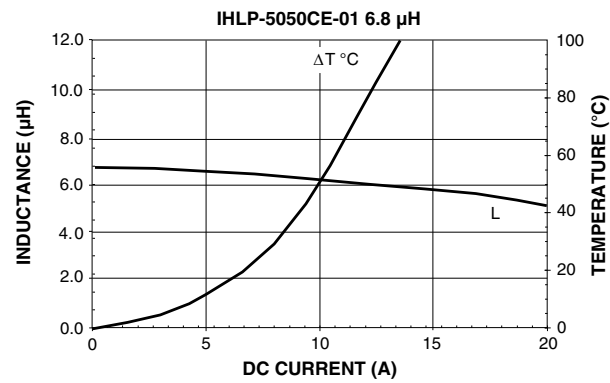
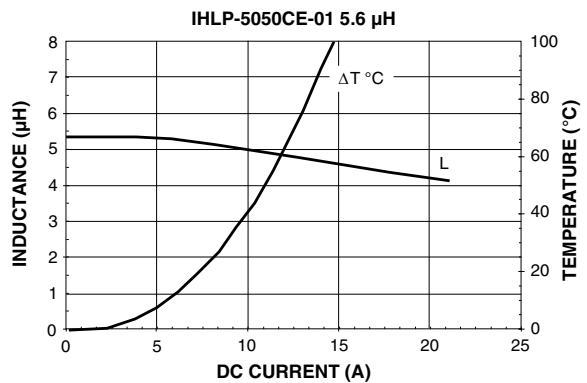
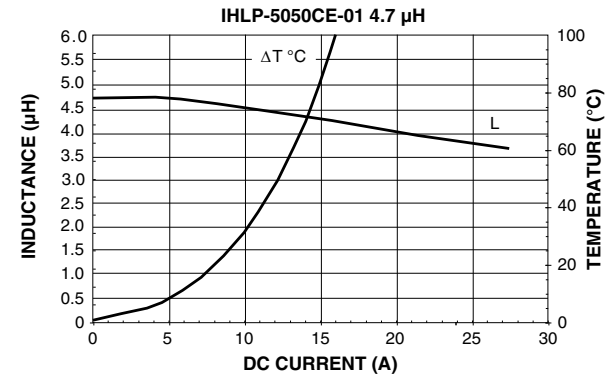
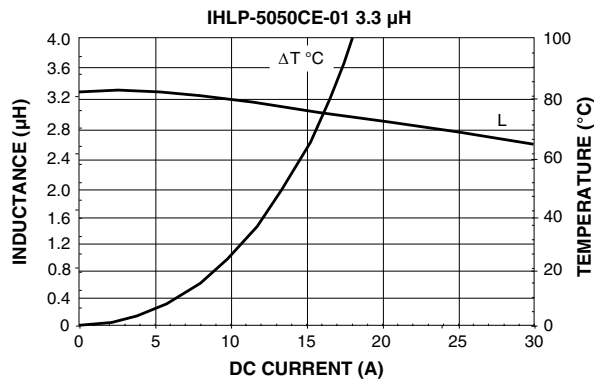
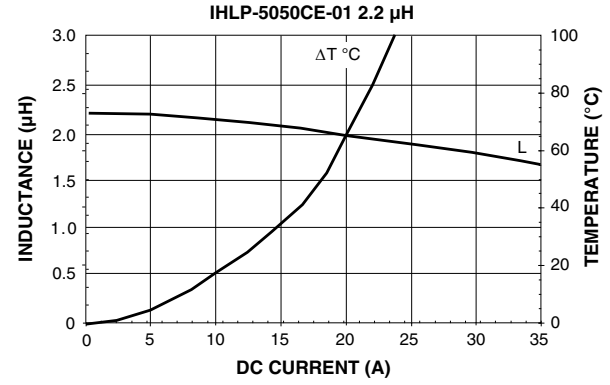
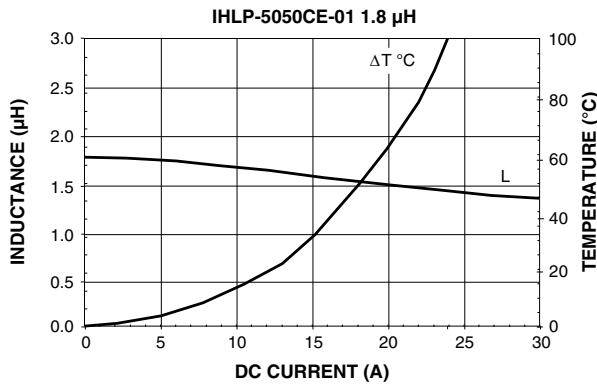
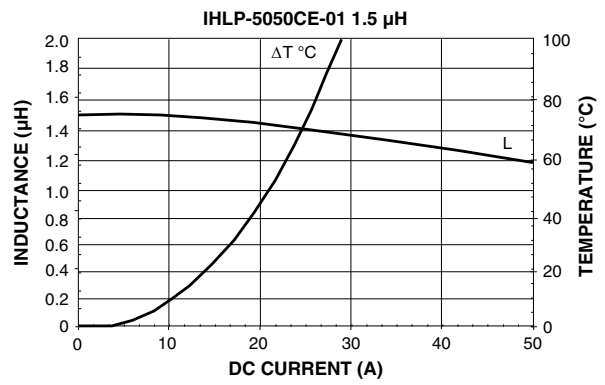
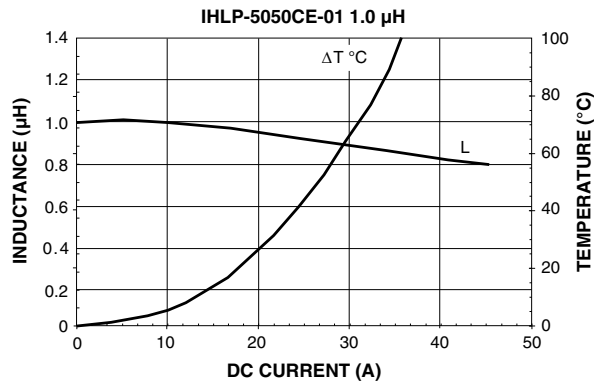

PERFORMANCE GRAPHS

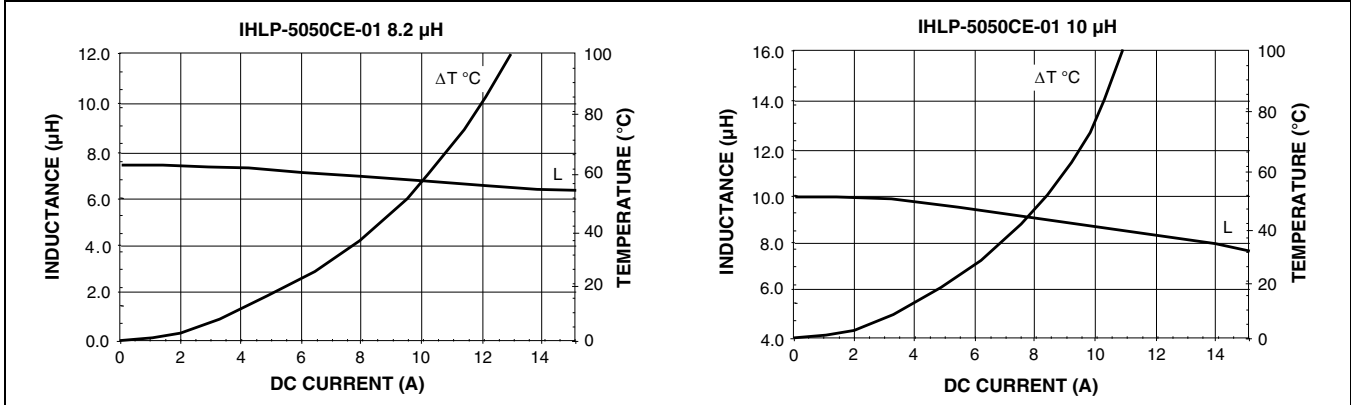

10 % DCR Tolerance, Low Profile, Power Inductors

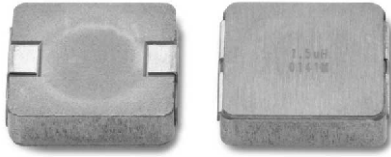

Manufactured under one or more of the following:
US Patents; 6,198,375/6,204,744/6,449,829/6,460,244.
 Several foreign patents, and other patents pending.

STANDARD ELECTRICAL SPECIFICATIONS			
L_0 INDUCTANCE $\pm 20\%$ AT 100 kHz, 0.25 V, 0 A (μH)	DCR $\pm 10\%$ AT 25 °C (m Ω)	HEAT RATING CURRENT DC TYP. (A) ⁽³⁾	SATURATION CURRENT DC TYP. (A) ⁽⁴⁾
0.60	1.85	29	51
0.68	2.34	28	49
1.0	3.21	24	40
1.5	4.97	19	35
2.2	7.20	16	29
3.3	10.69	12	27
4.7	14.27	10	24
5.6	18.19	9.5	19
10	30.86	7	14

Notes

- (1) All test data is referenced to 25 °C ambient
- (2) Operating temperature range - 55 °C to + 125 °C
- (3) DC current (A) that will cause an approximate ΔT of 40 °C
- (4) DC current (A) that will cause L_0 to drop approximately 20 %
- (5) The part temperature (ambient + temp. rise) should not exceed 125 °C under worst case operating conditions. Circuit design, component placement, PWB trace size and thickness, airflow and other cooling provisions all affect the part temperature. Part temperature should be verified in the end application.

FEATURES

- Lowest height (3.5 mm) in this package footprint
- Shielded construction
- Frequency range up to 5.0 MHz
- Lowest DCR/ μH , in this package size
- Handles high transient current spikes without saturation
- Ultra low buzz noise, due to composite construction
- Compliant to RoHS directive 2002/95/EC

RoHS
 COMPLIANT

APPLICATIONS

- Tolerance DCR for current sense applications
- Improved current balance in phased power supplies
- Improved thermal management
- PDA/notebook/desktop/server and battery powered devices
- High current, low profile POL converters
- DC/DC converters in distributed power systems
- DC/DC converter for Field Programmable Gate Array (FPGA)

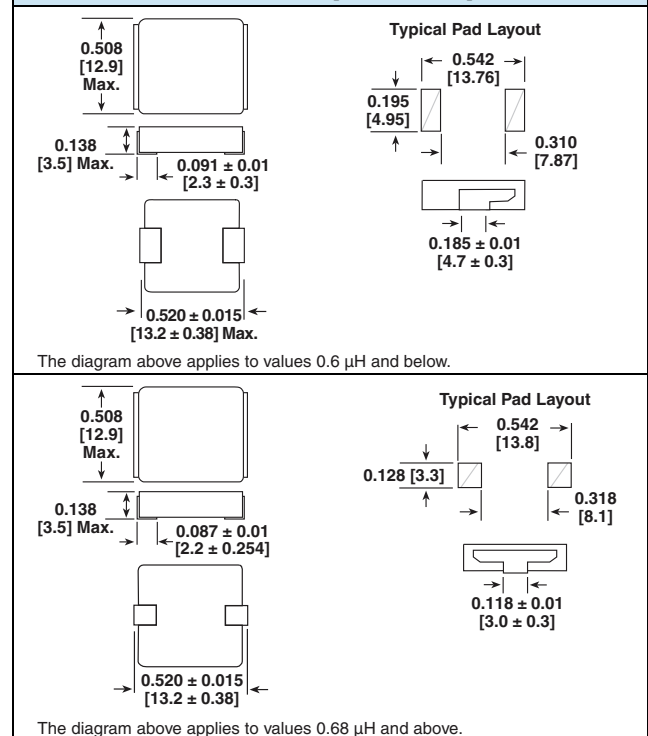
DIMENSIONS in inches [millimeters]

DESCRIPTION				
MODEL	INDUCTANCE VALUE	INDUCTANCE TOLERANCE	PACKAGE CODE	JEDEC LEAD (Pb)-FREE STANDARD
IHLP-5050CE-06	1.0 μH	$\pm 20\%$	ER	e3

GLOBAL PART NUMBER																	
I	H	L	P	5	0	5	0	C	E	E	R	1	R	0	M	0	6
PRODUCT FAMILY				SIZE				PACKAGE CODE		INDUCTANCE VALUE			TOL.		SERIES		



PERFORMANCE GRAPHS

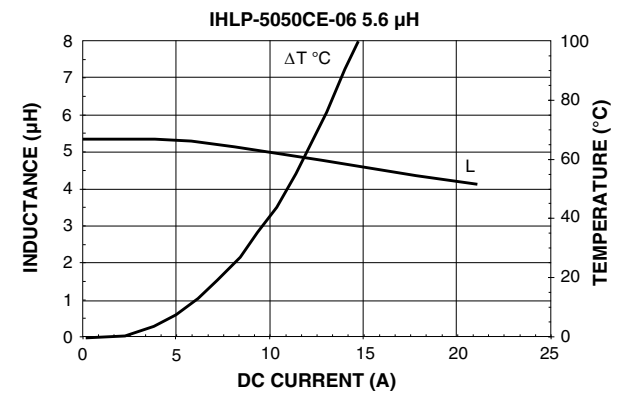
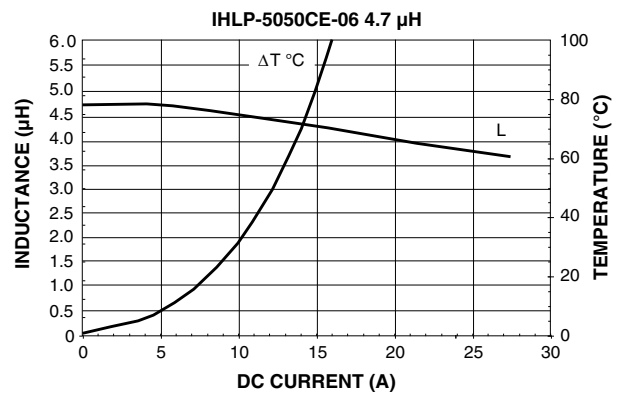
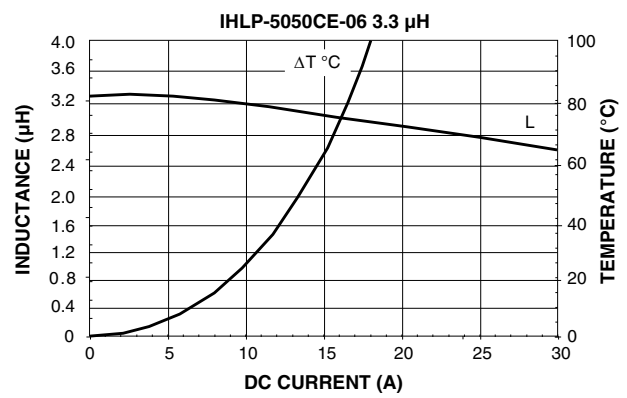
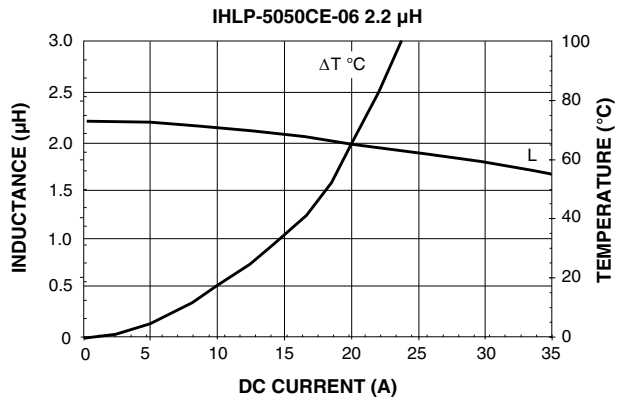
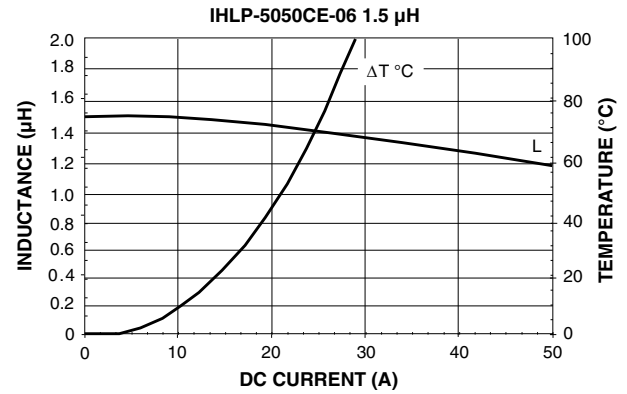
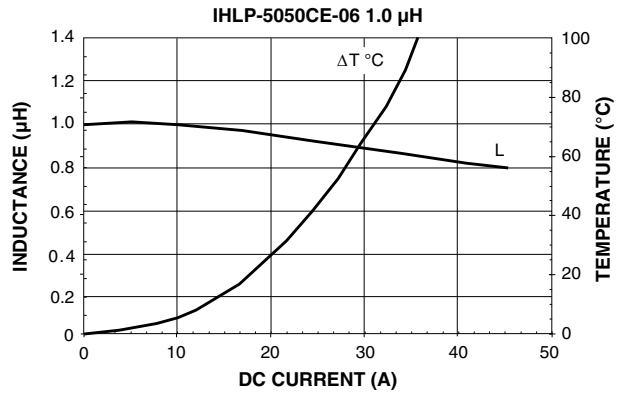
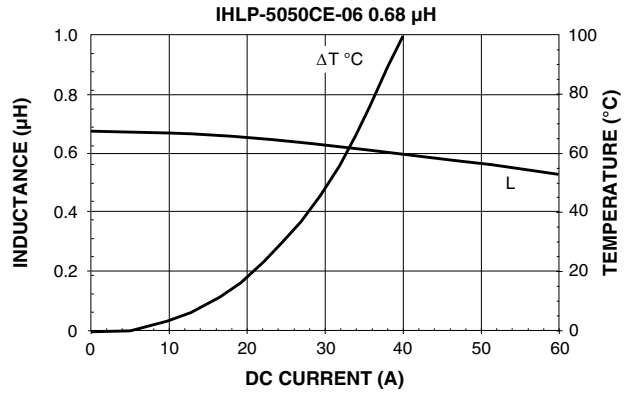
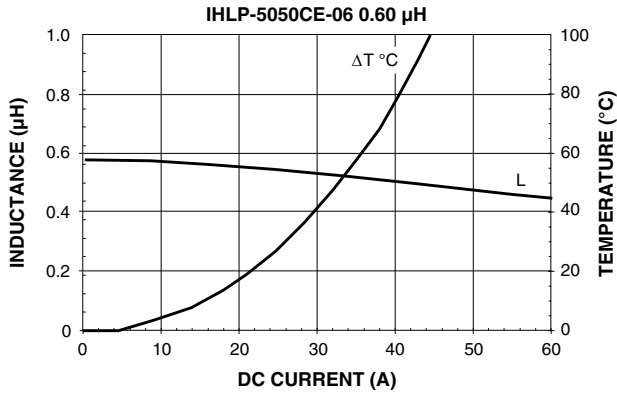



PERFORMANCE GRAPHS

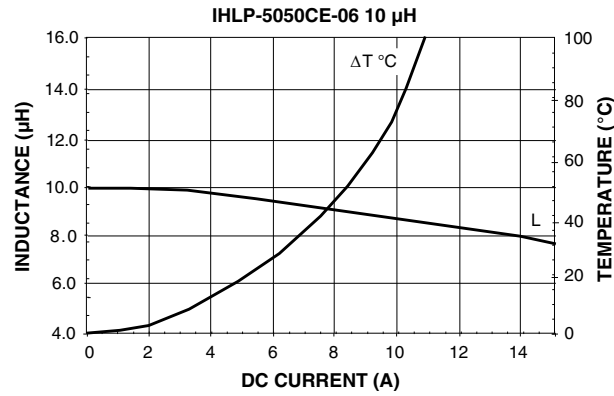

5 % DCR Tolerance, Low Profile, Power Inductors

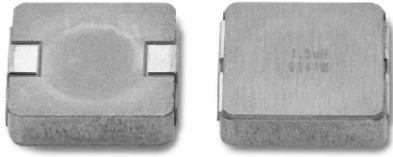

Manufactured under one or more of the following:
US Patents; 6,198,375/6,204,744/6,449,829/6,460,244.
 Several foreign patents, and other patents pending.



RoHS
COMPLIANT

FEATURES

- Lowest height (3.5 mm) in this package footprint
- Shielded construction
- Frequency range up to 5.0 MHz
- Lowest DCR/ μ H, in this package size
- Handles high transient current spikes without saturation
- Ultra low buzz noise, due to composite construction
- Compliant to RoHS directive 2002/95/EC

APPLICATIONS

- Tolerance DCR for current sense applications
- Improved current balance in phased power supplies
- Improved thermal management
- PDA/notebook/desktop/server and battery powered devices
- High current, low profile POL converters
- DC/DC converters in distributed power systems
- DC/DC converter for Field Programmable Gate Array (FPGA)

STANDARD ELECTRICAL SPECIFICATIONS			
L_0 INDUCTANCE $\pm 20\%$ AT 100 kHz, 0.25 V, 0 A (μ H)	DCR $\pm 5\%$ AT 25 °C (m Ω)	HEAT RATING CURRENT DC TYP. (A) ⁽³⁾	SATURATION CURRENT DC TYP. (A) ⁽⁴⁾
0.60	1.85	29	51
0.68	2.34	28	49
1.0	3.21	24	40
1.5	4.97	19	35
2.2	7.20	16	29
3.3	10.69	12	27
4.7	14.27	10	24
5.6	18.19	9.5	19
10	30.86	7	14

Notes

- (1) All test data is referenced to 25 °C ambient
- (2) Operating temperature range - 55 °C to + 125 °C
- (3) DC current (A) that will cause an approximate ΔT of 40 °C
- (4) DC current (A) that will cause L_0 to drop approximately 20 %
- (5) The part temperature (ambient + temp. rise) should not exceed 125 °C under worst case operating conditions. Circuit design, component placement, PWB trace size and thickness, airflow and other cooling provisions all affect the part temperature. Part temperature should be verified in the end application.

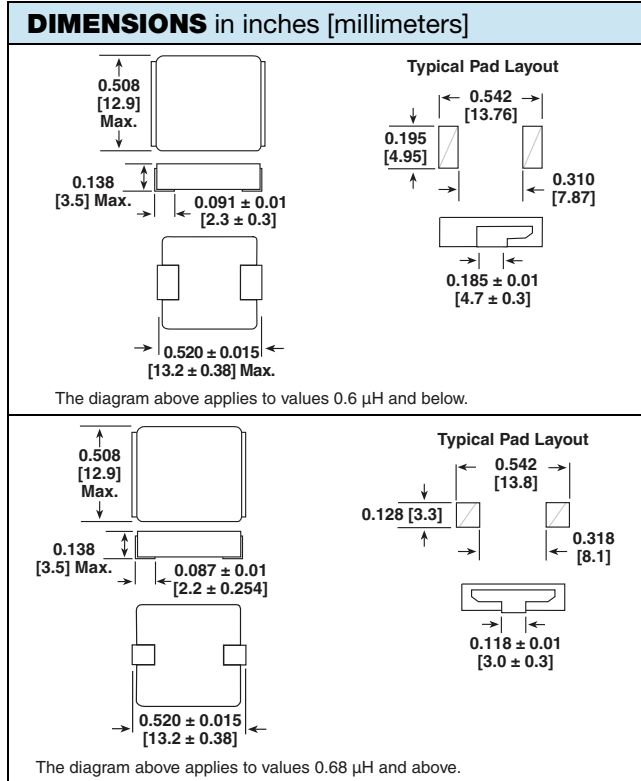

DESCRIPTION				
MODEL	INDUCTANCE VALUE	INDUCTANCE TOLERANCE	PACKAGE CODE	JEDEC LEAD (Pb)-FREE STANDARD
IHLP-5050CE-07	1.0 μ H	$\pm 20\%$	ER	e3

GLOBAL PART NUMBER																	
I	H	L	P	5	0	5	0	C	E	E	R	1	R	0	M	0	7
PRODUCT FAMILY				SIZE				PACKAGE CODE		INDUCTANCE VALUE			TOL.		SERIES		



PERFORMANCE GRAPHS

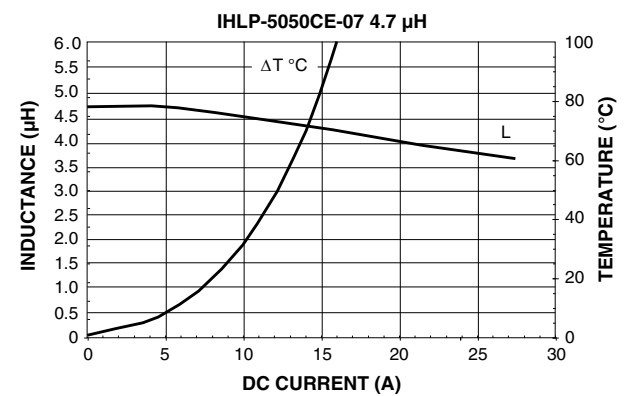
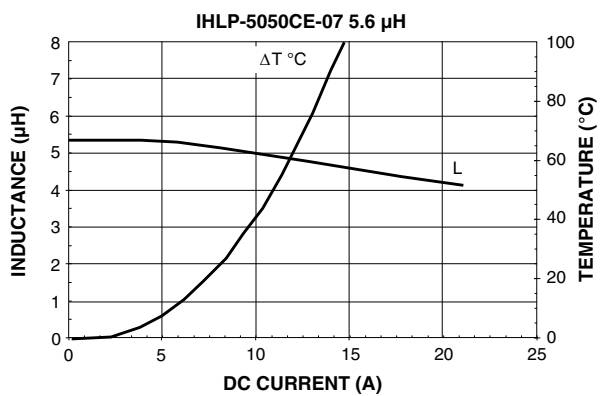
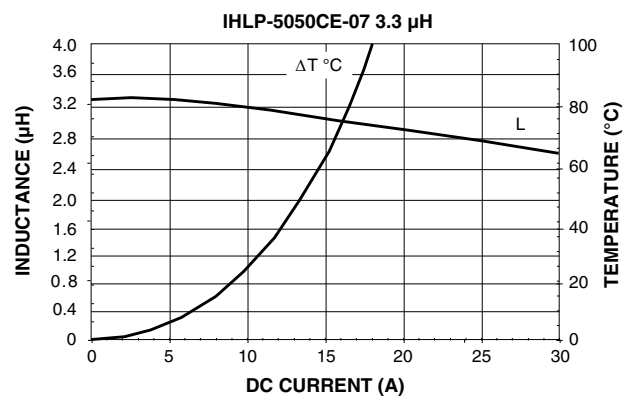
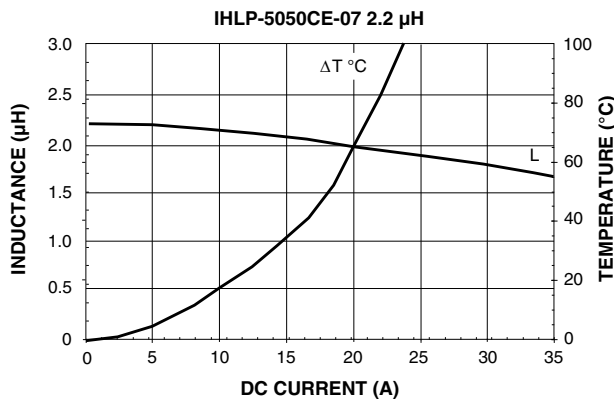
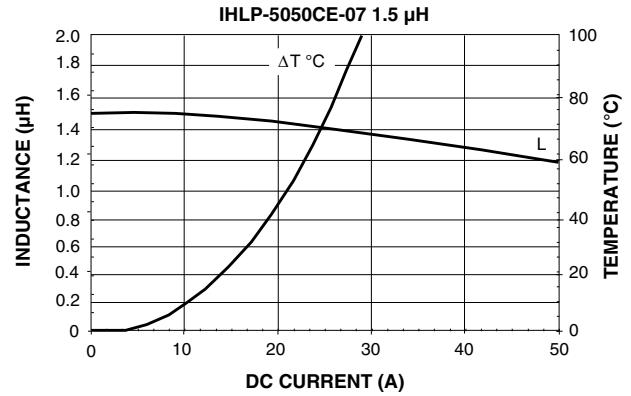
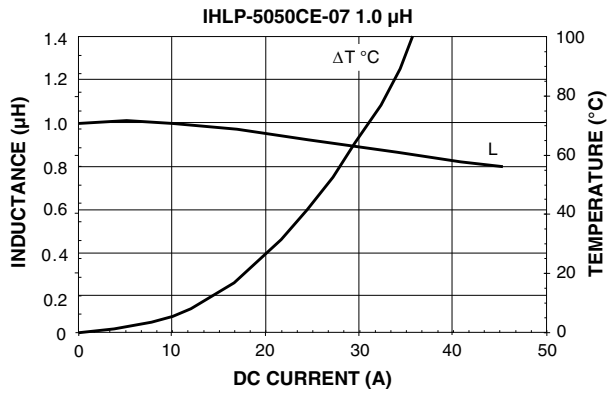
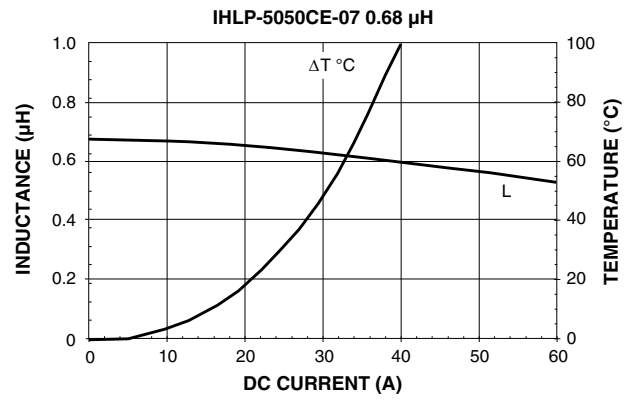
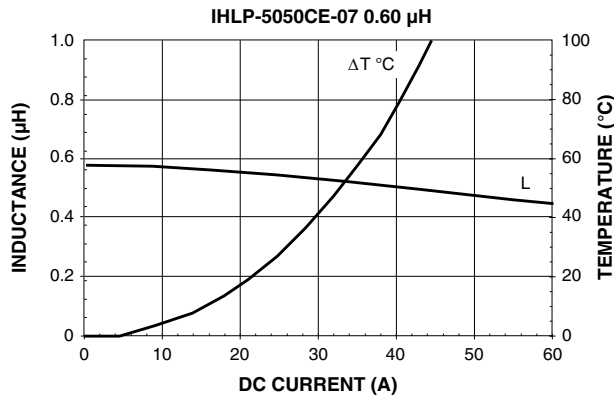

PERFORMANCE GRAPHS

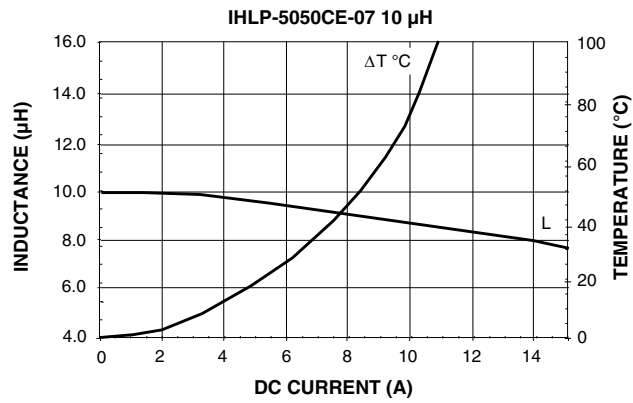

Low Profile, High Current IHLP® Inductors



Manufactured under one or more of the following:
US Patents; 6,198,375/6,204,744/6,449,829/6,460,244.
 Several foreign patents, and other patents pending.

STANDARD ELECTRICAL SPECIFICATIONS				
L_0 INDUCTANCE $\pm 20\%$ AT 100 kHz, 0.25 V, 0 A (μH)	DCR TYP. 25 °C (m Ω)	DCR MAX. 25 °C (m Ω)	HEAT RATING CURRENT DC TYP. (A) ⁽³⁾	SATURATION CURRENT DC TYP. (A) ⁽⁴⁾
0.10	0.53	0.60	55	118
0.22	0.64	0.80	51	110
0.33	0.85	1.1	42	80
0.47	1.1	1.3	38	65
0.56	1.3	1.5	36	55
0.68	1.5	1.7	34	54
0.82	2.0	2.3	31	53
1.0	2.1	2.5	29	50
1.5	3.4	4.1	23	48
1.8	4.2	4.9	19	40
2.2	4.6	5.5	20	32
3.3	7.7	9.2	15	32
4.7	12.8	15.0	12	27
5.6	14.0	16.5	11.5	22
6.8	15.4	18.5	11	21
7.8	17.2	20.5	10	18
8.2	18.9	22.5	9.5	18
10	21.4	25.5	9.0	16

Notes

- (1) All test data is referenced to 25 °C ambient
- (2) Operating temperature range - 55 °C to + 125 °C
- (3) DC current (A) that will cause an approximate ΔT of 40 °C
- (4) DC current (A) that will cause L_0 to drop approximately 20 %
- (5) The part temperature (ambient + temp. rise) should not exceed 125 °C under worst case operating conditions. Circuit design, component placement, PWB trace size and thickness, airflow and other cooling provisions all affect the part temperature. Part temperature should be verified in the end application.

FEATURES

- Shielded construction
- Frequency range up to 5.0 MHz
- Lowest DCR/ μH , in this package size
- Handles high transient current spikes without saturation
- Ultra low buzz noise, due to composite construction
- Compliant to RoHS Directive 2002/95/EC



RoHS
COMPLIANT
GREEN
(5-2008)**

APPLICATIONS

- Notebook/desktop/server applications
- High current POL converters
- Low profile, high current power supplies
- Battery powered devices
- DC/DC converters in distributed power systems
- DC/DC converter for Field Programmable Gate Array (FPGA)

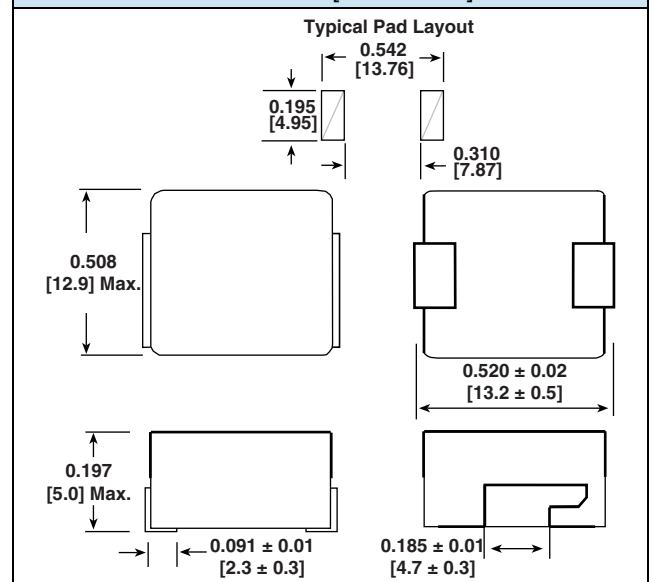
DIMENSIONS in inches [millimeters]

DESCRIPTION

IHLP-5050EZ-01	1.0 μH	$\pm 20\%$	ER	e3
MODEL	INDUCTANCE VALUE	INDUCTANCE TOLERANCE	PACKAGE CODE	JEDEC LEAD (Pb)-FREE STANDARD

GLOBAL PART NUMBER

I	H	L	P	5	0	5	0	E	Z	E	R	1	R	0	M	0	1
PRODUCT FAMILY				SIZE				PACKAGE CODE		INDUCTANCE VALUE		TOL.	SERIES				

** Please see document "Vishay Material Category Policy": www.vishay.com/doc?99902

PERFORMANCE GRAPHS

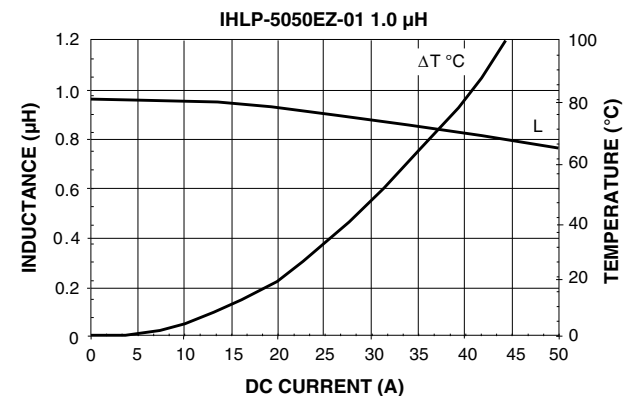
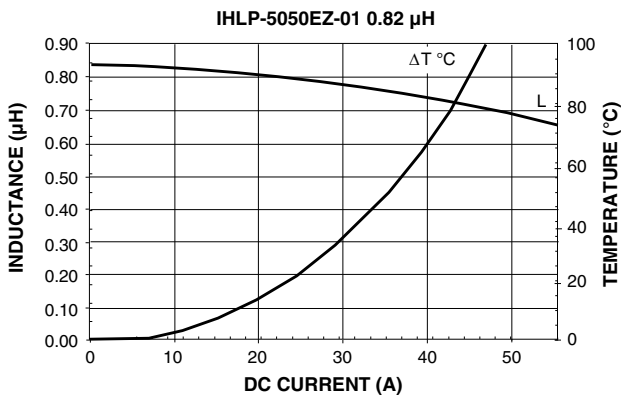
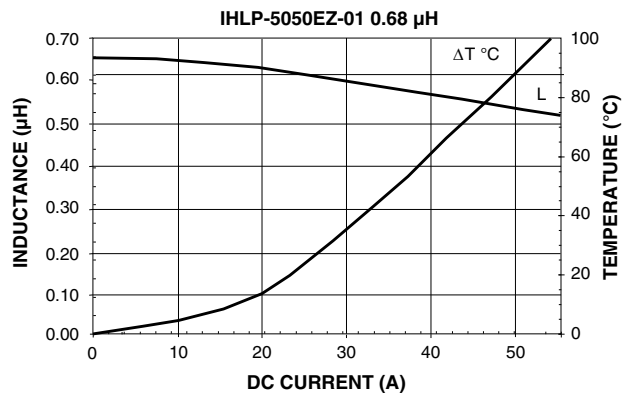
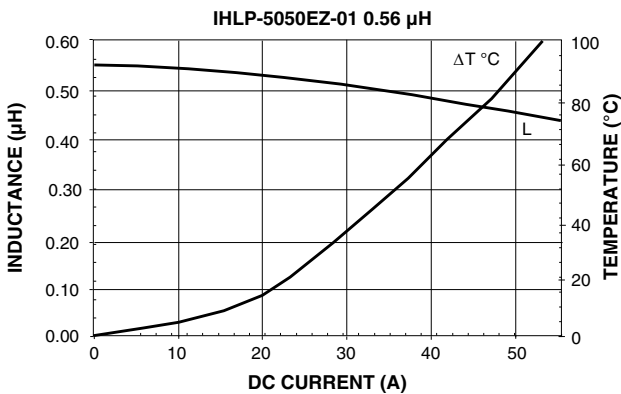
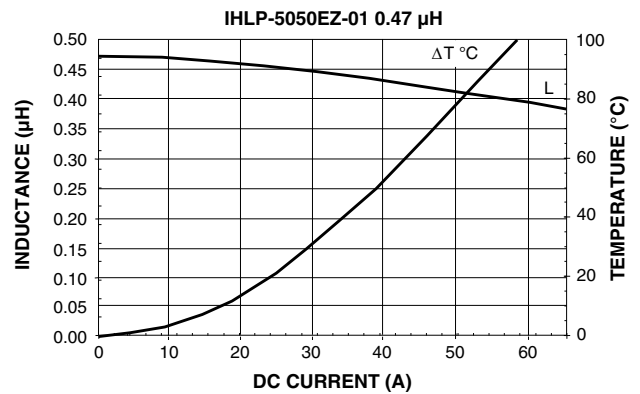
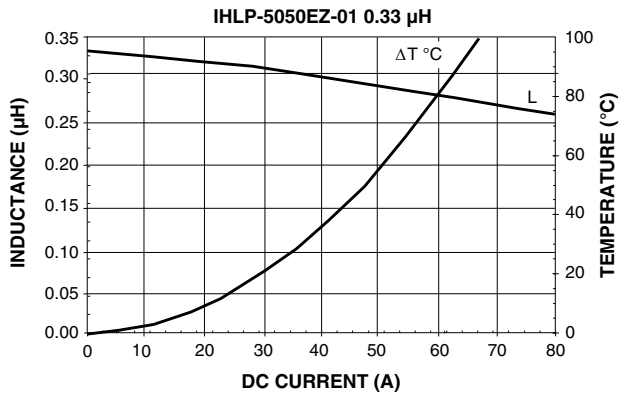
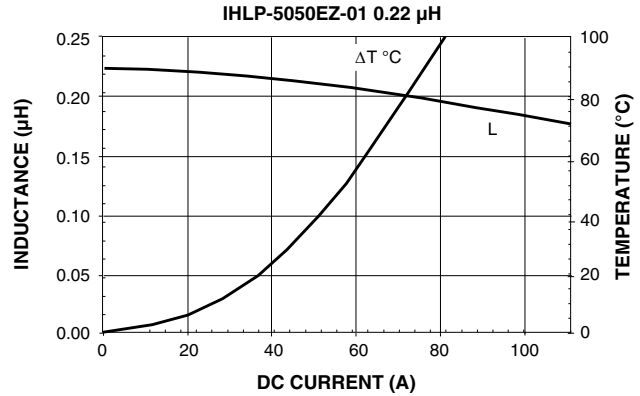
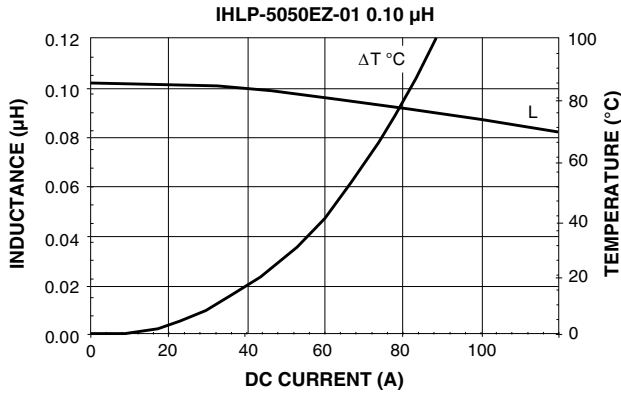



PERFORMANCE GRAPHS

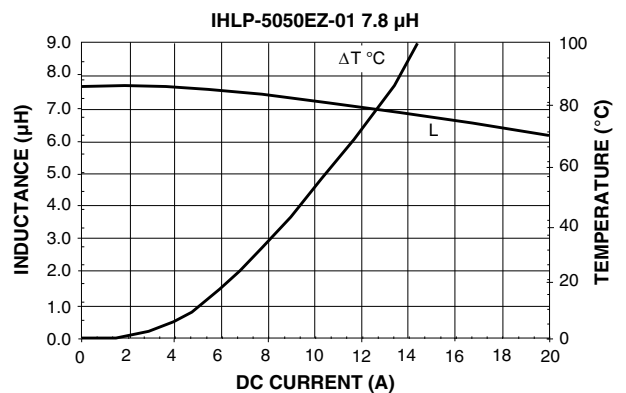
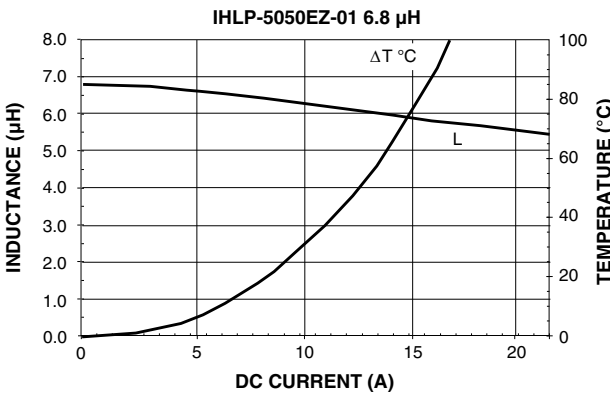
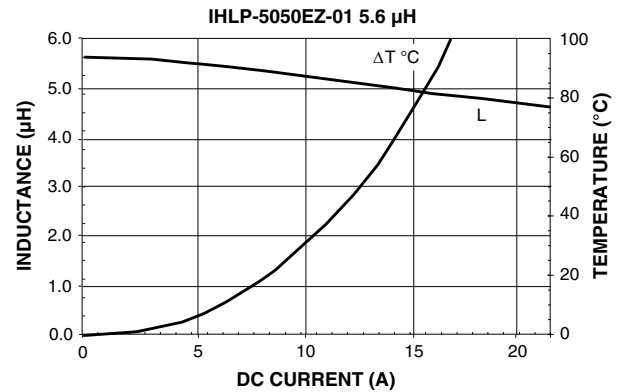
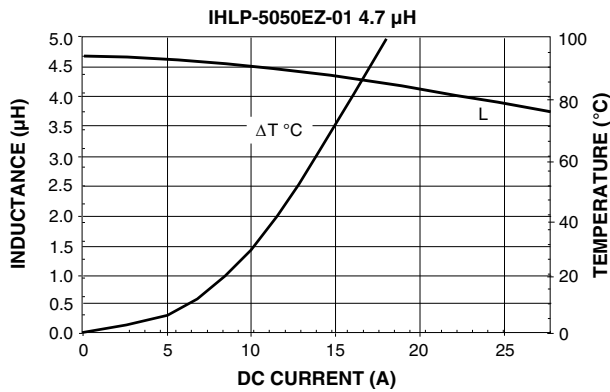
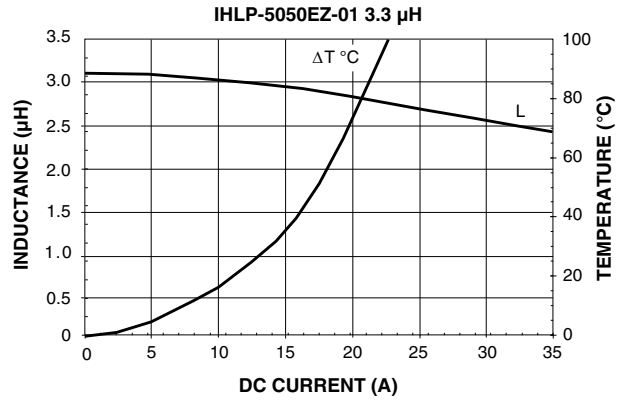
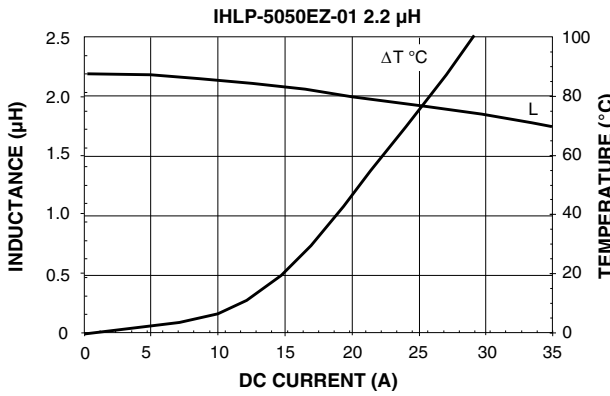
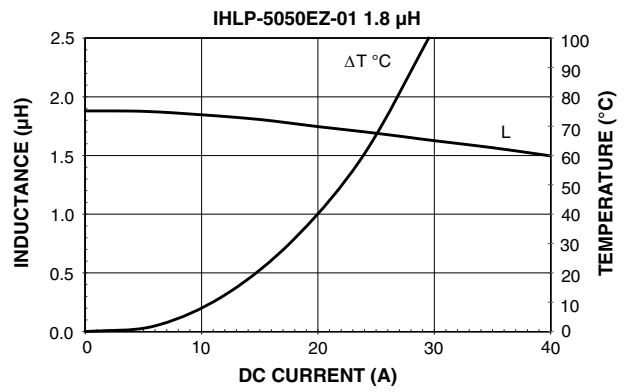
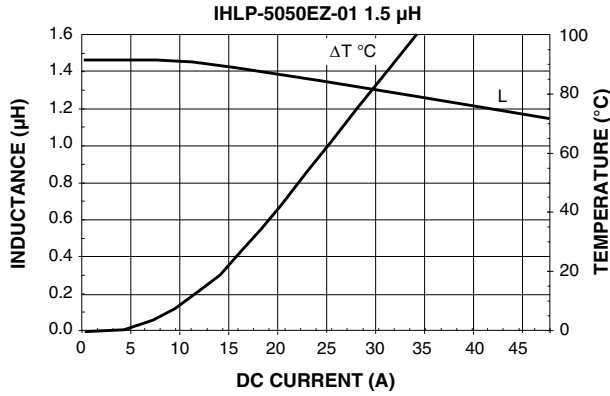

PERFORMANCE GRAPHS

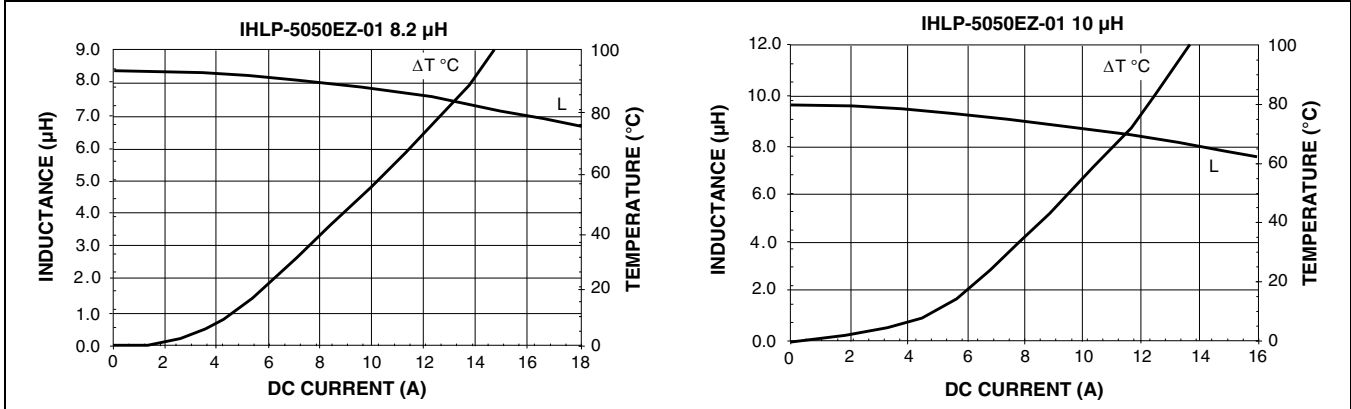

Low Profile, High Current IHLP® Inductors



Manufactured under one or more of the following:
US Patents; 6,198,375/6,204,744/6,449,829/6,460,244.
 Several foreign patents, and other patents pending.

STANDARD ELECTRICAL SPECIFICATIONS				
L ₀ INDUCTANCE ± 20 % AT 100 kHz, 0.25 V, 0 A (μH)	DCR TYP. 25 °C (mΩ)	DCR MAX. 25 °C (mΩ)	HEAT RATING CURRENT DC TYP. (A) ⁽³⁾	SATURATION CURRENT DC TYP. (A) ⁽⁴⁾
0.10	0.47	0.50	60	120
0.15	0.53	0.60	55	118
0.22	0.63	0.70	53	112
0.30	0.70	0.80	48	72
0.33	0.83	0.90	46	65
0.40	0.90	1.0	44	64
0.47	1.0	1.2	41	63
0.56	1.2	1.4	37	62
0.68	1.4	1.6	35	60
0.82	1.6	1.9	33	50
1.0	1.7	2.0	32	49
1.2	2.1	2.5	30	48
1.5	2.5	3.0	27	45
1.8	2.8	3.2	24	41
2.2	3.5	4.2	22	40
3.3	5.7	6.8	18	35
4.7	8.0	8.7	13.5	32
5.6	9.3	10	13.5	32
6.8	13.1	14	11.5	16.5
8.2	14.5	15.5	10.5	16
10	16.4	17.2	10	15.5

Notes

- (1) All test data is referenced to 25 °C ambient
- (2) Operating temperature range - 55 °C to + 125 °C
- (3) DC current (A) that will cause an approximate ΔT of 40 °C
- (4) DC current (A) that will cause L₀ to drop approximately 20 %
- (5) The part temperature (ambient + temp. rise) should not exceed 125 °C under worst case operating conditions. Circuit design, component placement, PWB trace size and thickness, airflow and other cooling provisions all affect the part temperature. Part temperature should be verified in the end application.

FEATURES

- Shielded construction
- Frequency range up to 5.0 MHz
- Lowest DCR/μH, in this package size
- Handles high transient current spikes without saturation
- Ultra low buzz noise, due to composite construction
- Compliant to RoHS Directive 2002/95/EC

RoHS
 COMPLIANT

GREEN
 (5-2008)**

APPLICATIONS

- Notebook/desktop/server applications
- High current POL converters
- Low profile, high current power supplies
- Battery powered devices
- DC/DC converters in distributed power systems
- DC/DC converter for Field Programmable Gate Array (FPGA)

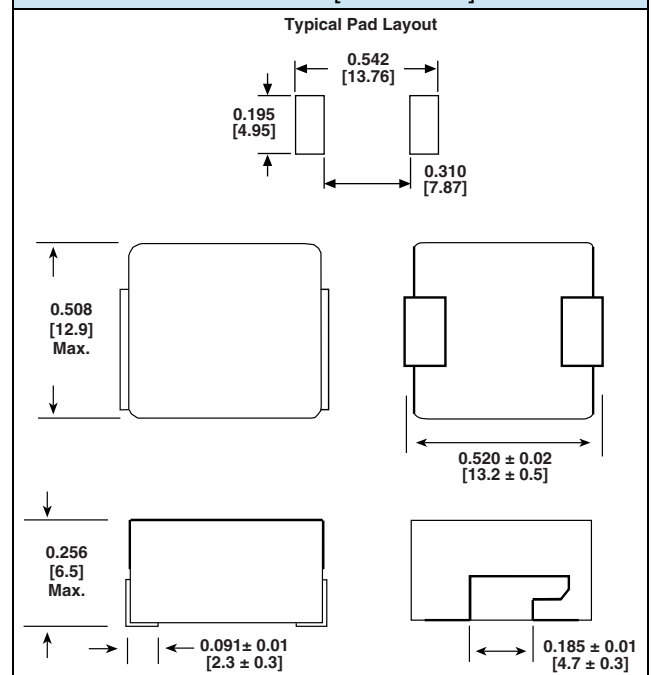
DIMENSIONS in inches [millimeters]

DESCRIPTION

IHLP-5050FD-01	1.0 μH	± 20 %	ER	e3
MODEL	INDUCTANCE VALUE	INDUCTANCE TOLERANCE	PACKAGE CODE	JEDEC LEAD (Pb)-FREE STANDARD

GLOBAL PART NUMBER

I	H	L	P	5	0	5	0	F	D	E	R	1	R	0	M	0	1
PRODUCT FAMILY				SIZE				PACKAGE CODE		INDUCTANCE VALUE		TOL.		SERIES			

** Please see document "Vishay Material Category Policy": www.vishay.com/doc?99902

PERFORMANCE GRAPHS

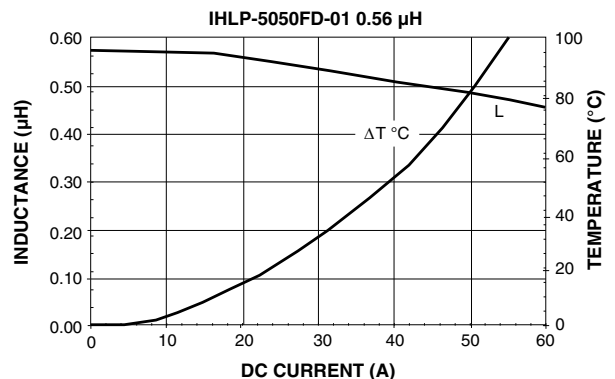
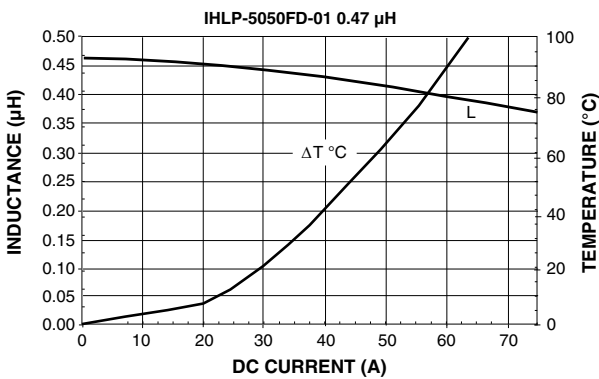
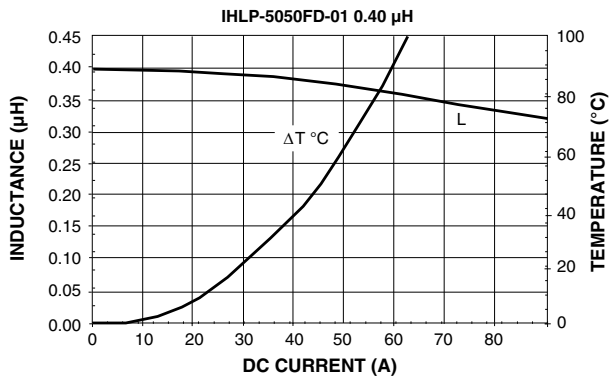
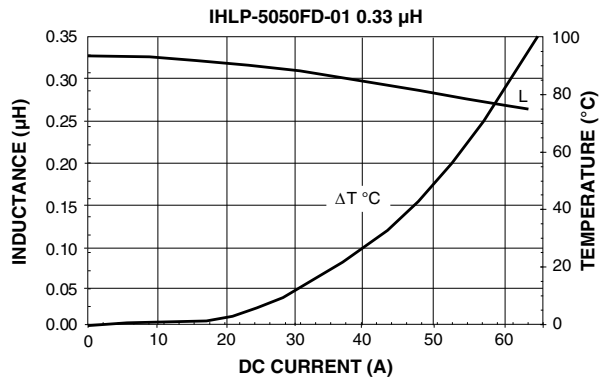
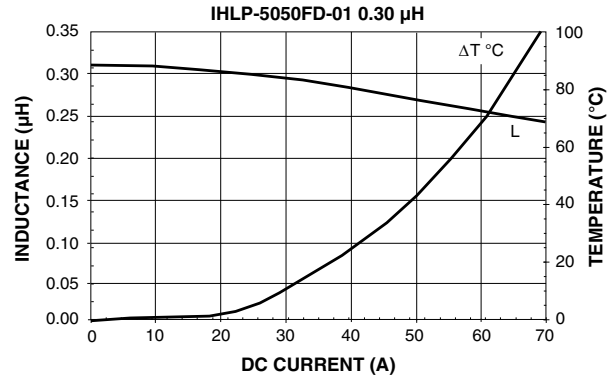
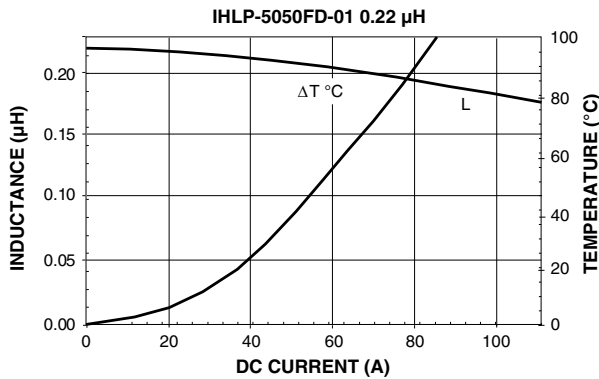
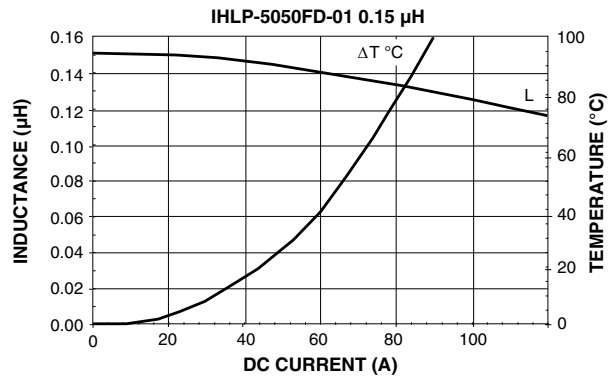
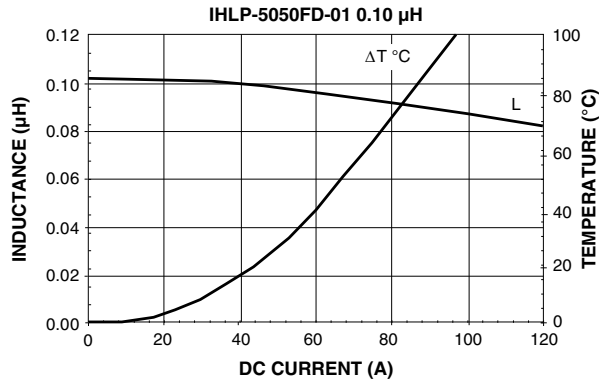



PERFORMANCE GRAPHS

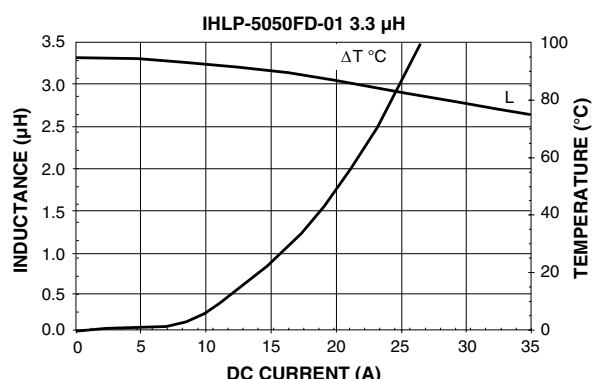
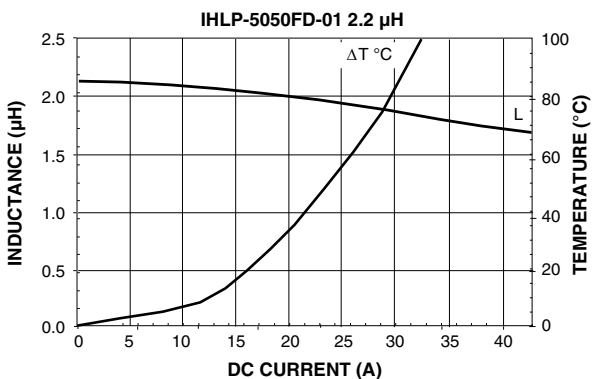
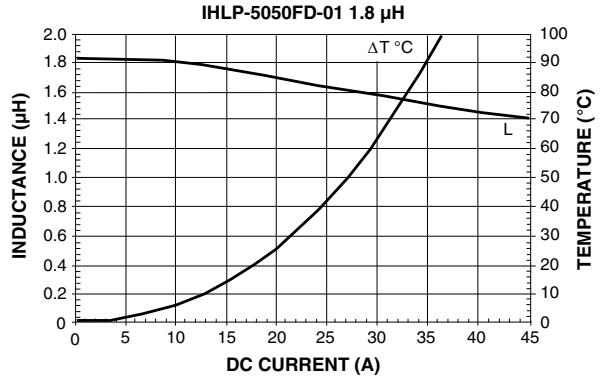
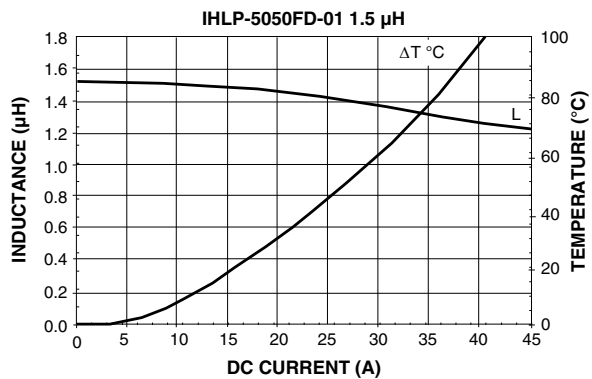
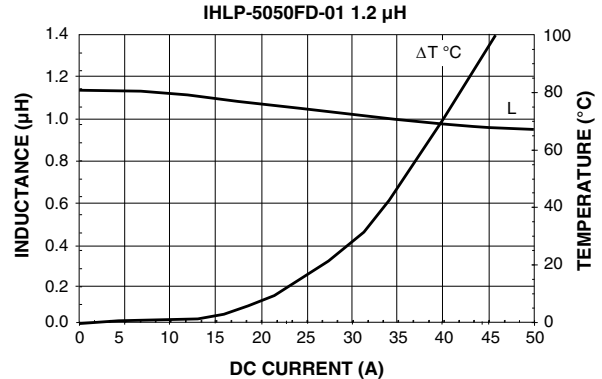
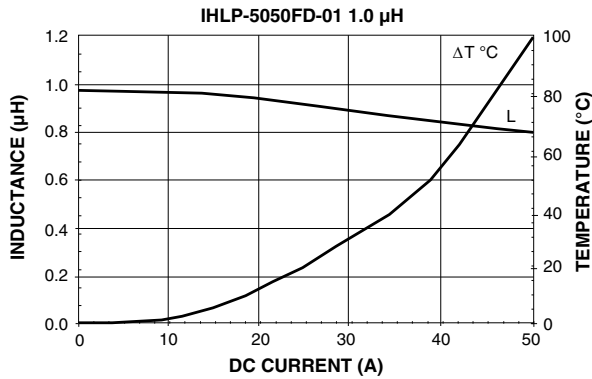
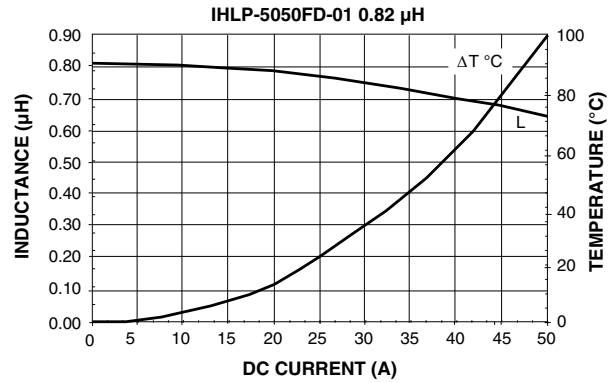
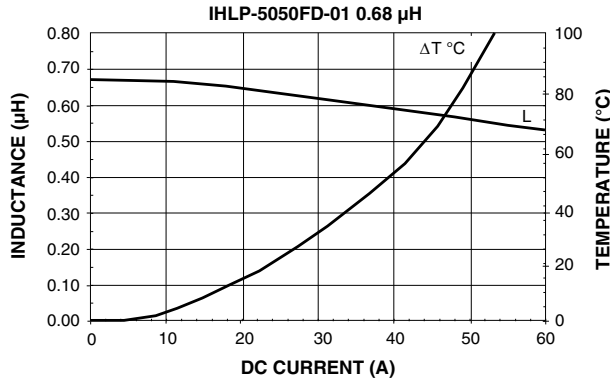

PERFORMANCE GRAPHS

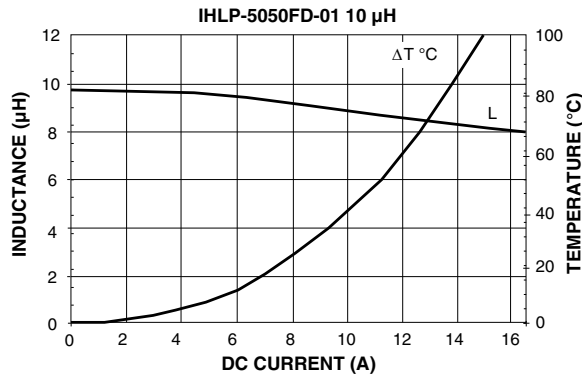
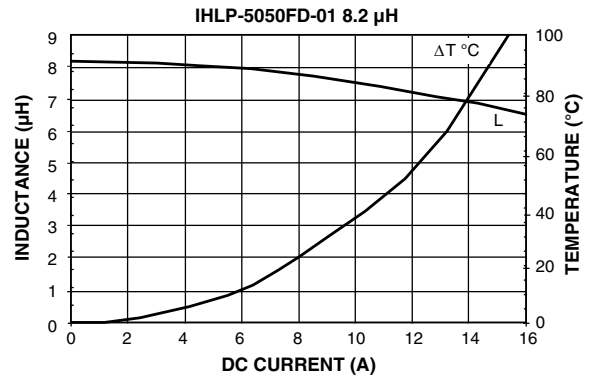
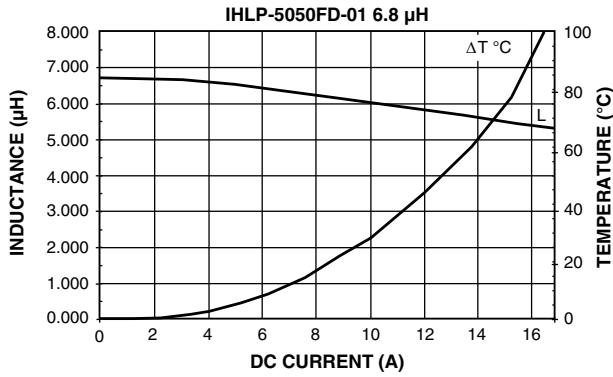
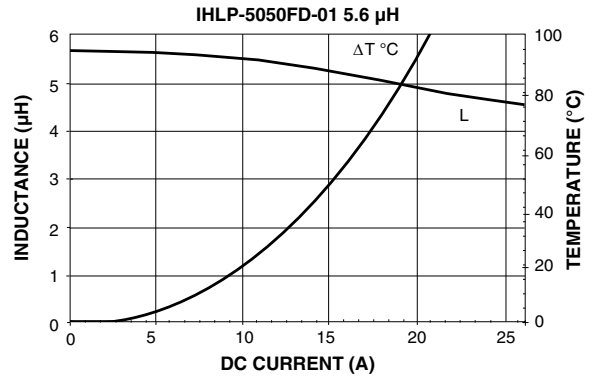
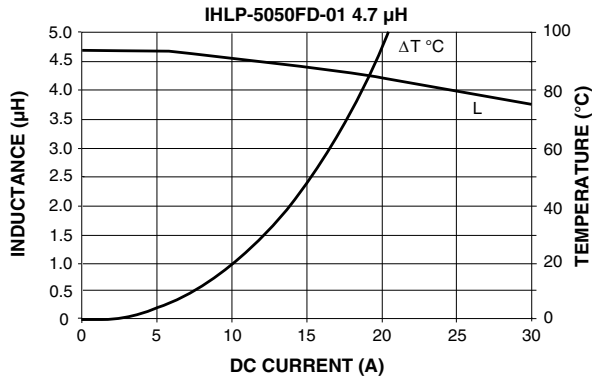

Low Profile, High Current IHLP® Inductors

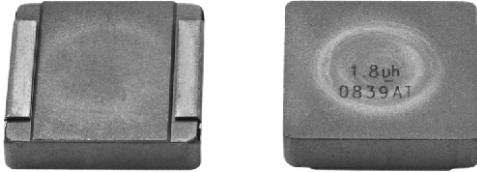

Manufactured under one or more of the following:
US Patents; 6,198,375/6,204,744/6,449,829/6,460,244.
 Several foreign patents, and other patents pending.

STANDARD ELECTRICAL SPECIFICATIONS				
L ₀ INDUCTANCE ± 20 % AT 100 kHz, 0.25 V, 0 A (µH)	DCR TYP. 25 °C (mΩ)	DCR MAX. 25 °C (mΩ)	HEAT RATING CURRENT DC TYP. (A) ⁽³⁾	SATURATION CURRENT DC TYP. (A) ⁽⁴⁾
0.22	0.80	0.88	75.0	92.0
0.33	1.16	1.28	56.0	82.0
0.47	1.31	1.38	49.0	77.0
0.56	1.45	1.52	47.0	62.0
0.68	1.90	2.00	41.0	60.0
0.82	2.17	2.28	38.5	51.0
1.0	2.53	2.66	31.5	58.0
1.5	4.50	4.73	23.5	40.0
2.2	6.10	6.40	19.0	30.0
3.3	9.06	9.51	18.5	28.0
4.7	10.70	11.20	16.0	27.0
5.6	13.40	14.10	14.0	26.0
6.8	15.20	16.00	13.2	21.0
8.2	16.80	17.60	11.5	20.0
10.0	24.40	25.60	10.5	19.5

Notes

- (1) All test data is referenced to 25 °C ambient
- (2) Operating temperature range - 55 °C to + 125 °C
- (3) DC current (A) that will cause an approximate ΔT of 40 °C
- (4) DC current (A) that will cause L₀ to drop approximately 20 %
- (5) The part temperature (ambient + temp. rise) should not exceed 125 °C under worst case operating conditions. Circuit design, component placement, PWB trace size and thickness, airflow and other cooling provisions all affect the part temperature. Part temperature should be verified in the end application.

FEATURES

- Shielded construction
- Frequency range up to 2.0 MHz
- Lowest DCR/µH, in this package size
- Handles high transient current spikes without saturation
- Ultra low buzz noise, due to composite construction
- Compliant to RoHS Directive 2002/95/EC



RoHS
 COMPLIANT
GREEN
 (5-2008)**

APPLICATIONS

- PDA/notebook/desktop/server applications
- High current POL converters
- Low profile, high current power supplies
- Battery powered devices
- DC/DC converters in distributed power systems
- DC/DC converter for Field Programmable Gate Array (FPGA)

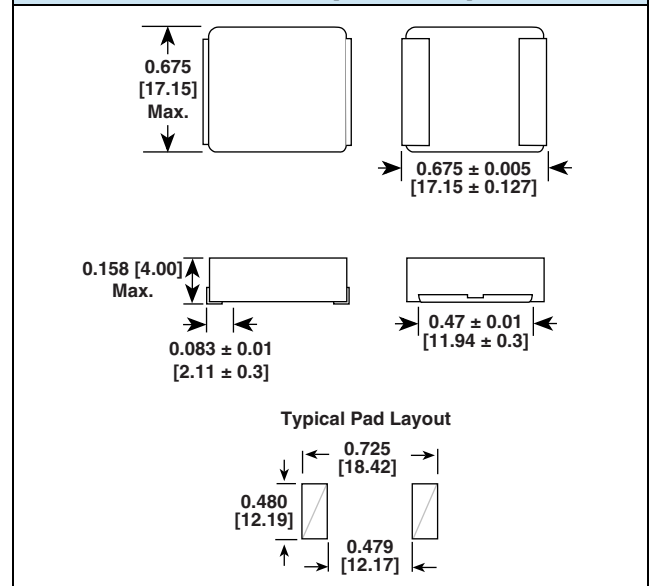
DIMENSIONS in inches [millimeters]

DESCRIPTION

IHLP-6767DZ-01	4.7 µH	± 20 %	ER	e3
MODEL	INDUCTANCE VALUE	INDUCTANCE TOLERANCE	PACKAGE CODE	JEDEC LEAD (Pb)-FREE STANDARD

GLOBAL PART NUMBER

I	H	L	P	6	7	6	7	D	Z	E	R	4	R	7	M	0	1
PRODUCT FAMILY				SIZE				PACKAGE CODE		INDUCTANCE VALUE			TOL.	SERIES			

** Please see document "Vishay Material Category Policy": www.vishay.com/doc?99902

PERFORMANCE GRAPHS

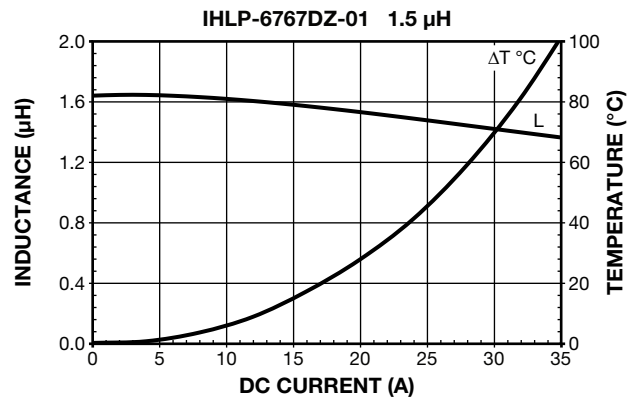
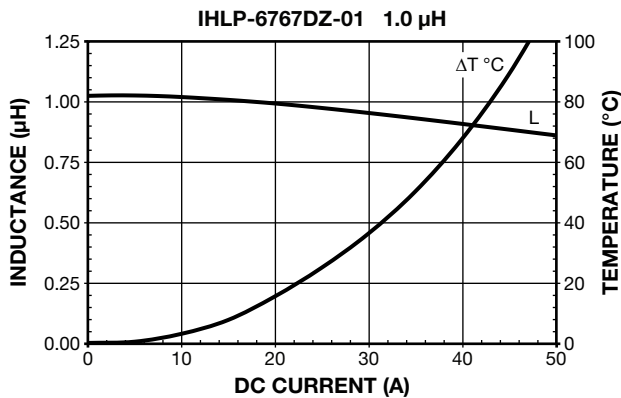
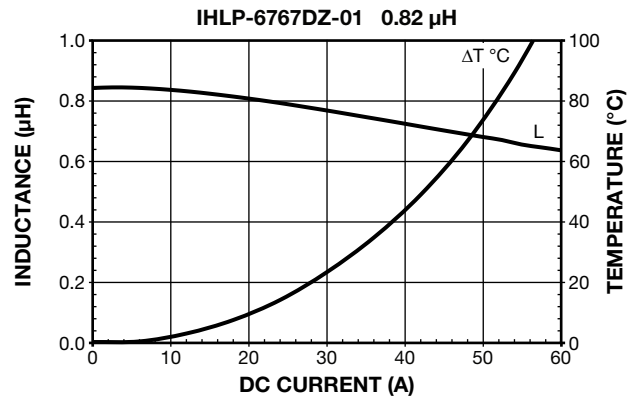
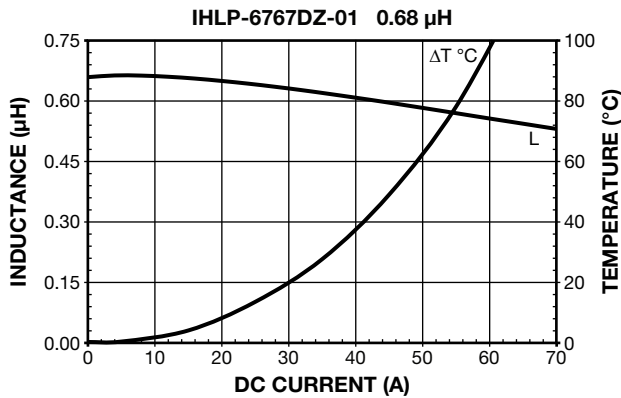
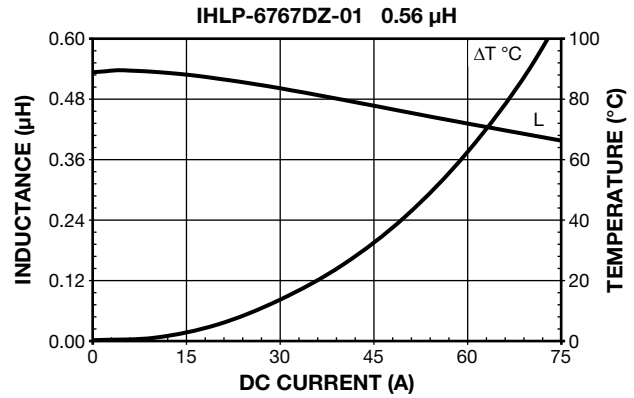
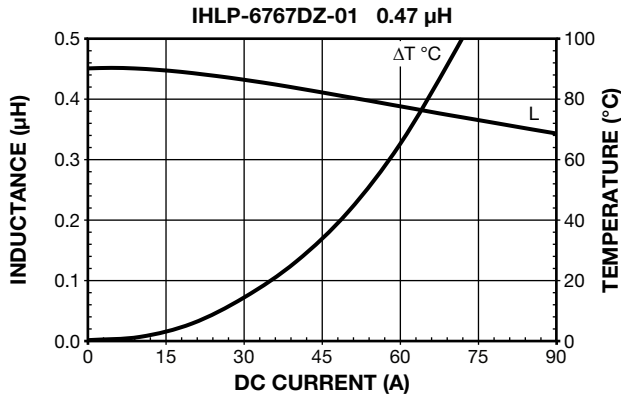
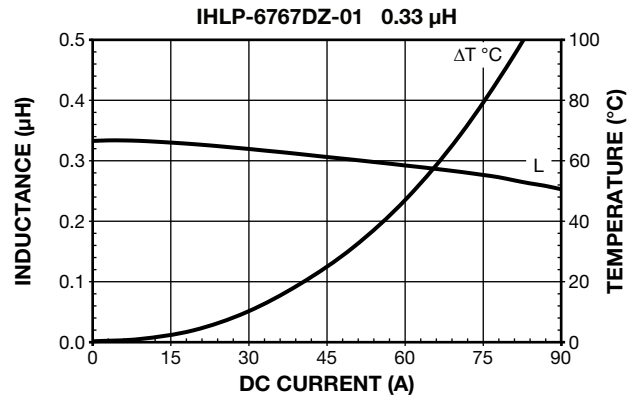
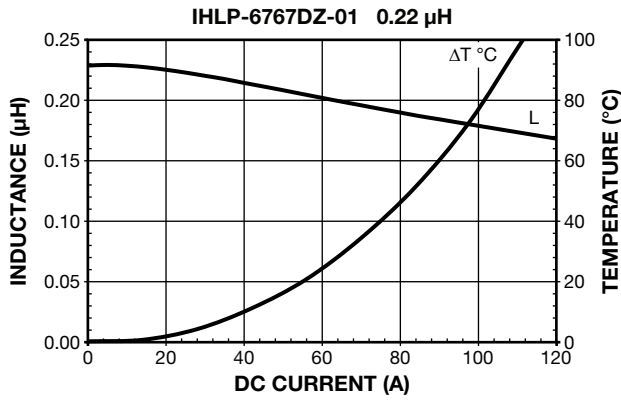



PERFORMANCE GRAPHS

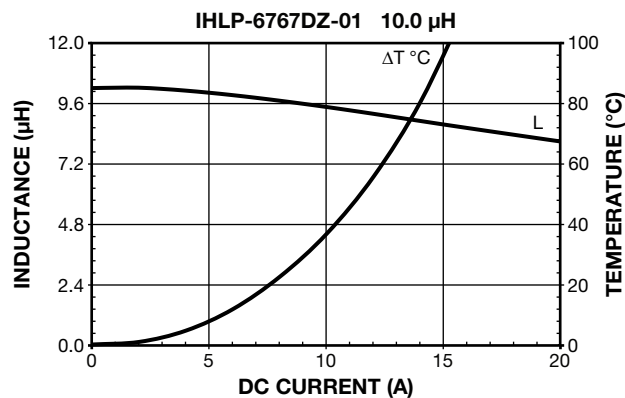
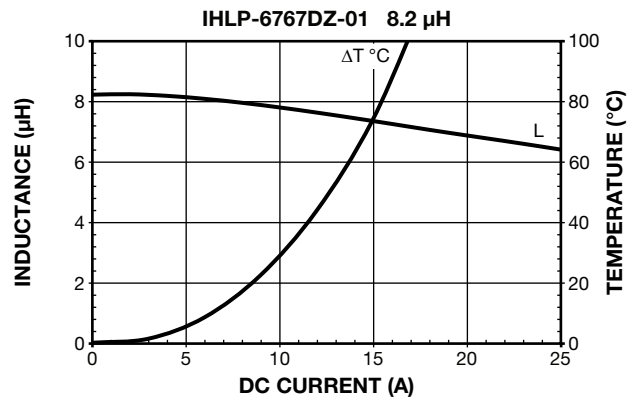
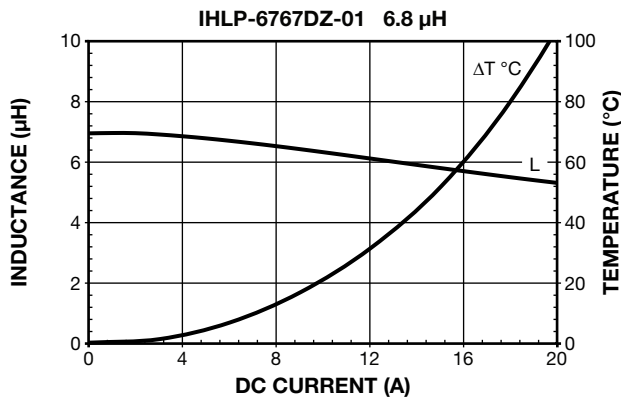
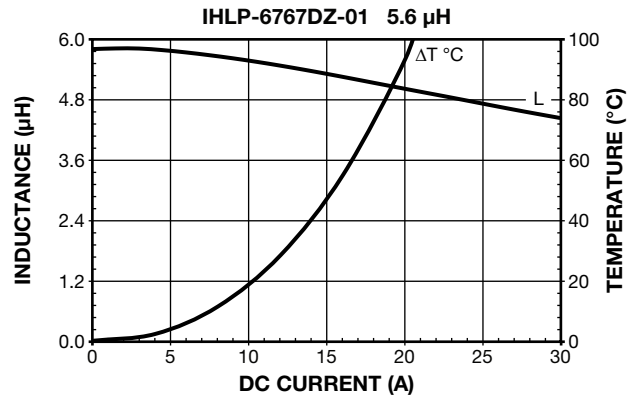
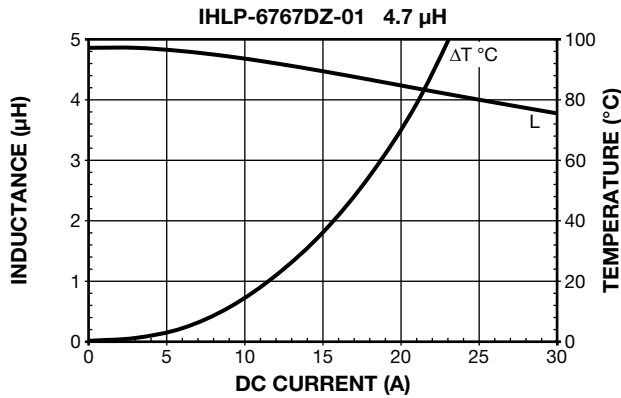
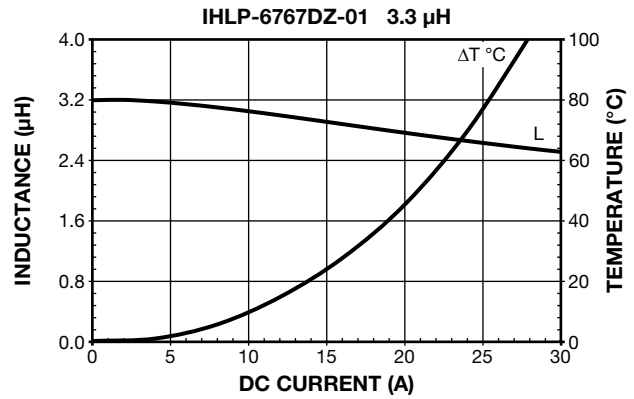
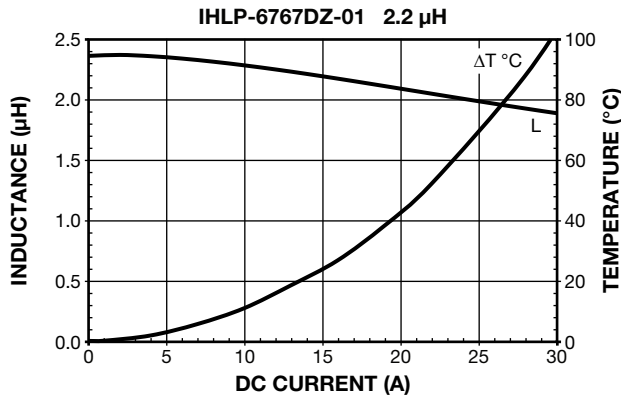

Low Profile, High Current IHLP® Inductors

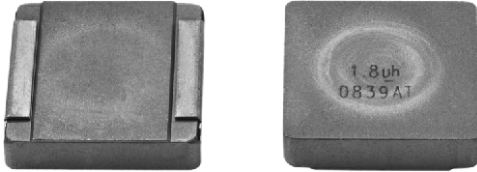

Manufactured under one or more of the following:
US Patents; 6,198,375/6,204,744/6,449,829/6,460,244.
 Several foreign patents, and other patents pending.

STANDARD ELECTRICAL SPECIFICATIONS				
L ₀ INDUCTANCE ± 20 % AT 100 kHz, 0.25 V, 0 A (µH)	DCR TYP. 25 °C (mΩ)	DCR MAX. 25 °C (mΩ)	HEAT RATING CURRENT DC TYP. (A) ⁽³⁾	SATURATION CURRENT DC TYP. (A) ⁽⁴⁾
1.0	1.86	2.05	41	27.5
1.5	3.12	3.43	31	21
2.2	4.57	5.03	26	19
3.3	6.64	7.30	20.5	14
4.7	8.47	9.32	18	12
5.6	11.09	12.20	15	11.5
6.8	12.54	13.79	14.5	10.5
10.0	17.2	18.92	12	8
15.0	27.8	30.58	9	7.5
22.0	42.7	46.97	7.2	6.2
33.0	64.4	70.84	6.5	6
47.0	98.60	108.46	5	4.3

Notes

- (1) All test data is referenced to 25 °C ambient
- (2) Operating temperature range - 55 °C to + 125 °C
- (3) DC current (A) that will cause an approximate ΔT of 40 °C
- (4) DC current (A) that will cause L₀ to drop approximately 20 %
- (5) The part temperature (ambient + temp. rise) should not exceed 125 °C under worst case operating conditions. Circuit design, component placement, PWB trace size and thickness, airflow and other cooling provisions all affect the part temperature. Part temperature should be verified in the end application.

FEATURES

- Shielded construction
- Frequency range up to 750 kHz
- Lowest DCR/µH, in this package size
- Handles high transient current spikes without saturation
- Ultra low buzz noise, due to composite construction
- Compliant to RoHS Directive 2002/95/EC
- Halogen-free according to IEC 61249-2-21 definition



RoHS
COMPLIANT
HALOGEN
FREE

APPLICATIONS

- PDA/notebook/desktop/server applications
- High current POL converters
- Low profile, high current power supplies
- Battery powered devices
- DC/DC converters in distributed power systems
- DC/DC converter for Field Programmable Gate Array (FPGA)

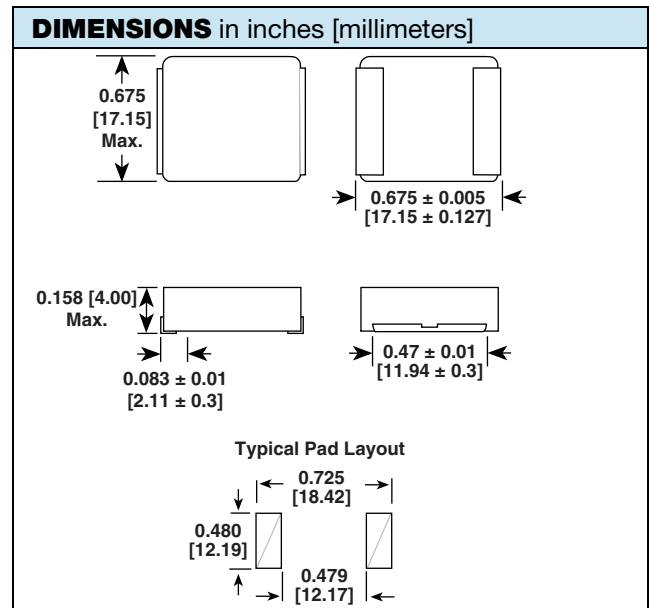

DESCRIPTION				
IHLP-6767DZ-11	4.7 µH	± 20 %	ER	e3
MODEL	INDUCTANCE VALUE	INDUCTANCE TOLERANCE	PACKAGE CODE	JEDEC LEAD (Pb)-FREE STANDARD

GLOBAL PART NUMBER																	
I	H	L	P	6	7	6	7	D	Z	E	R	4	R	7	M	1	1
PRODUCT FAMILY				SIZE				PACKAGE CODE		INDUCTANCE VALUE			TOL.	SERIES			

PERFORMANCE GRAPHS

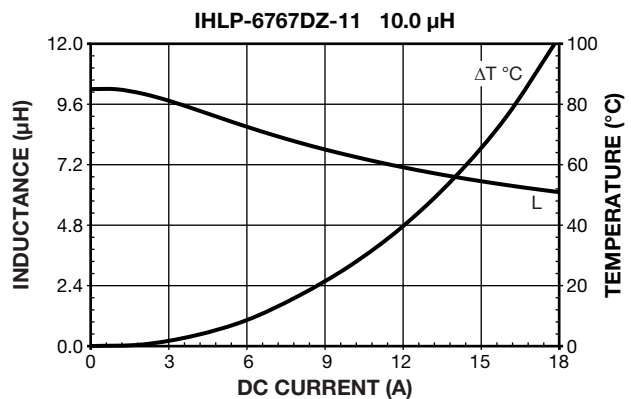
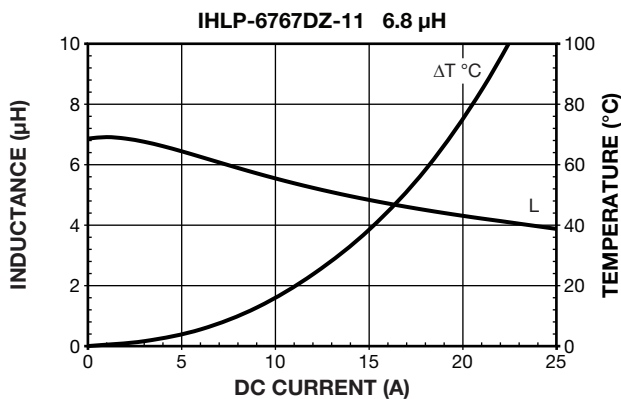
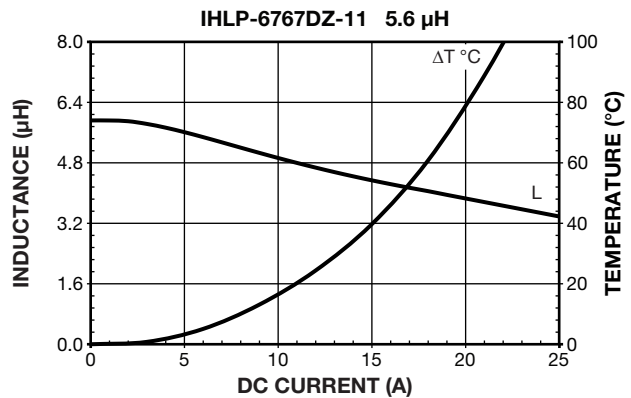
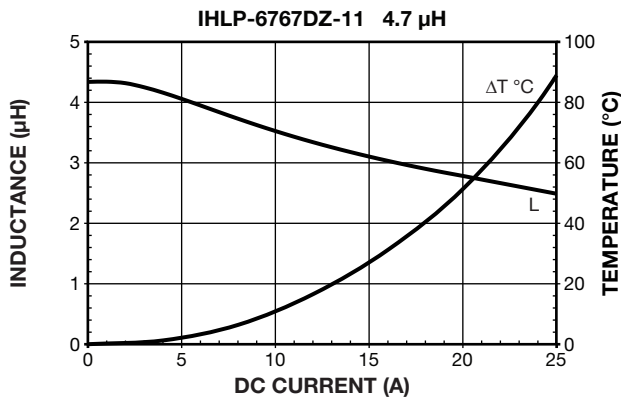
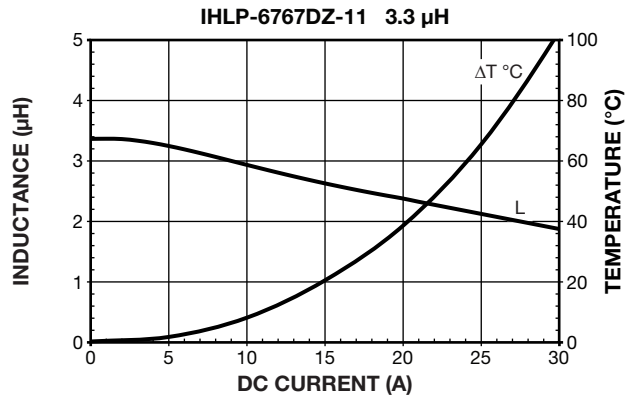
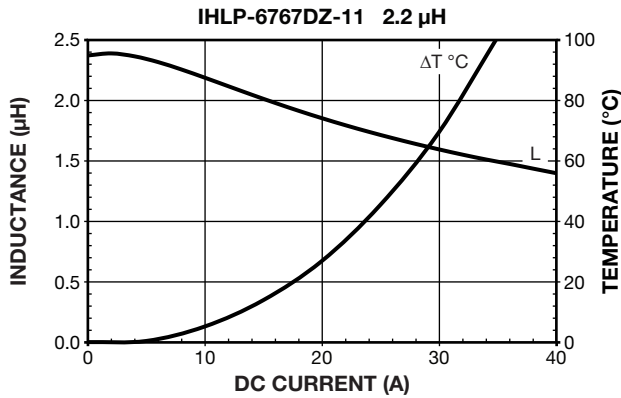
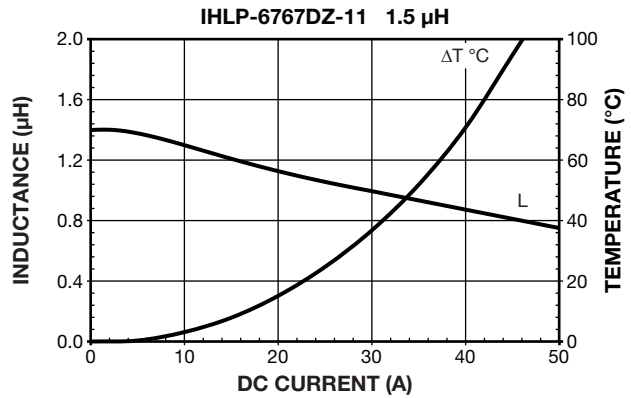
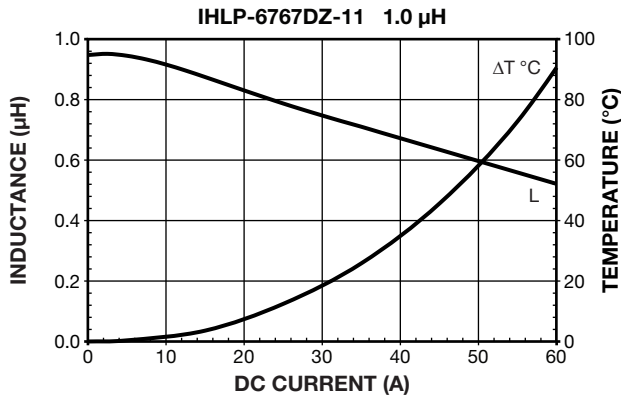



PERFORMANCE GRAPHS

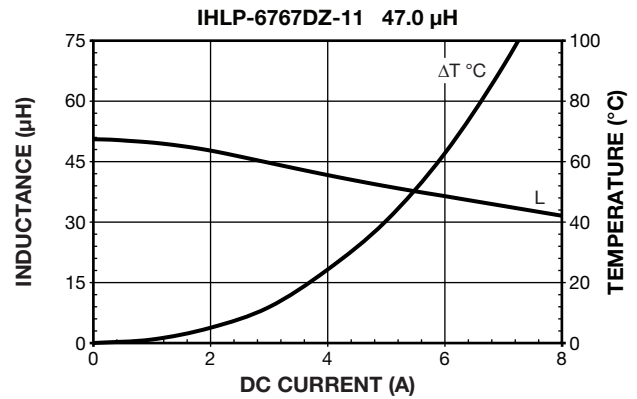
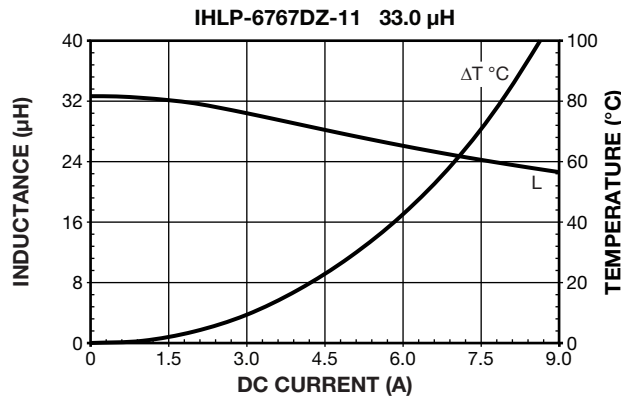
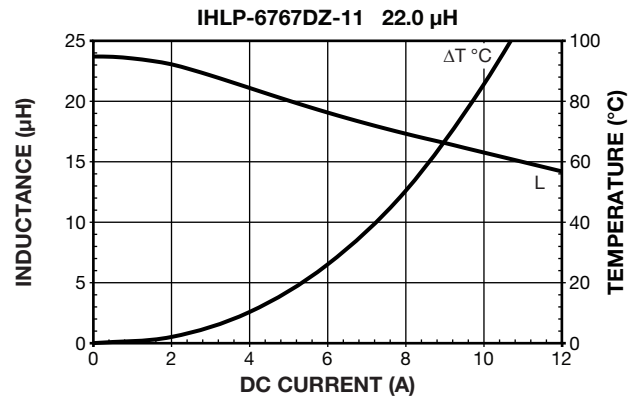
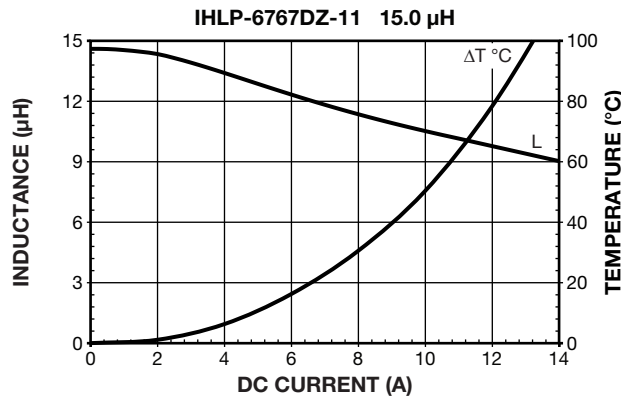

PERFORMANCE GRAPHS: INDUCTANCE AND Q VS. FREQUENCY

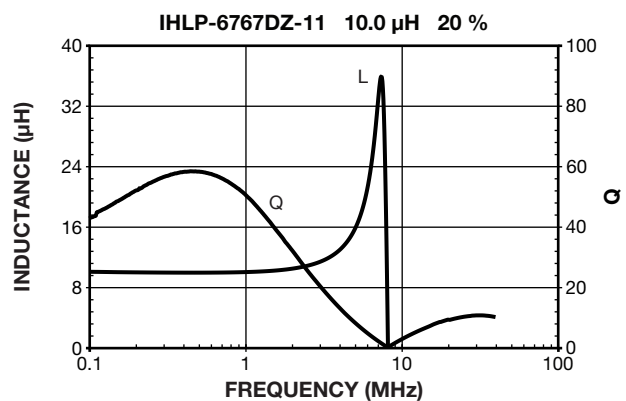
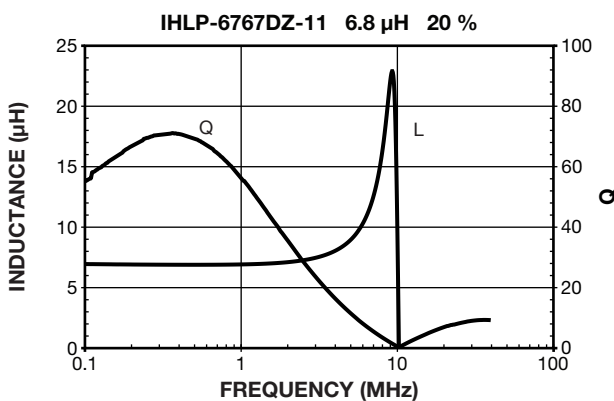
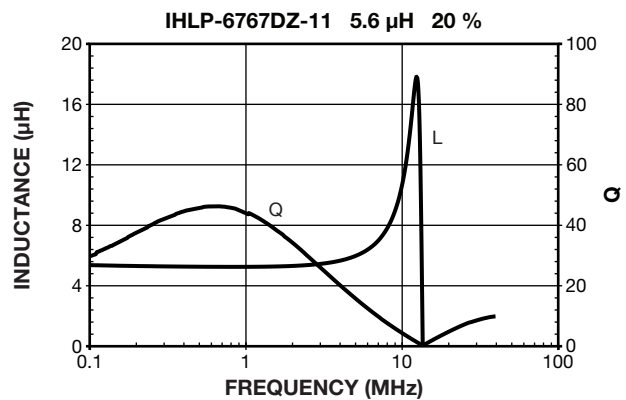
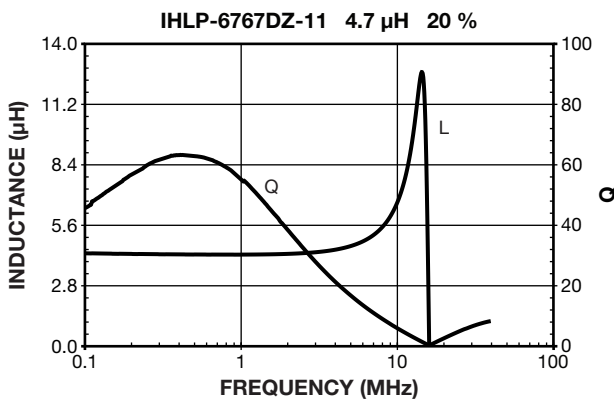
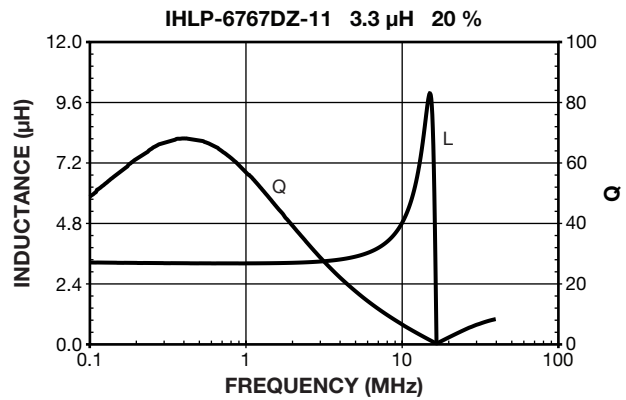
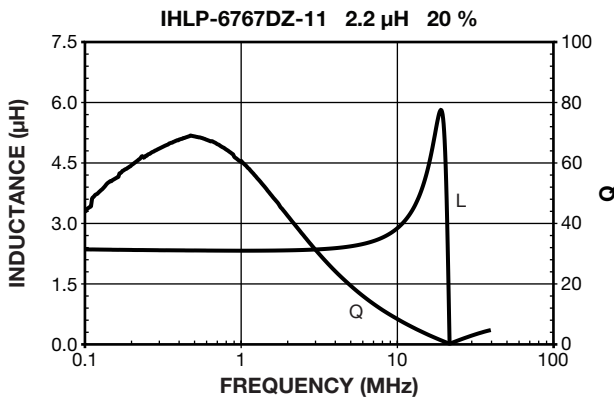
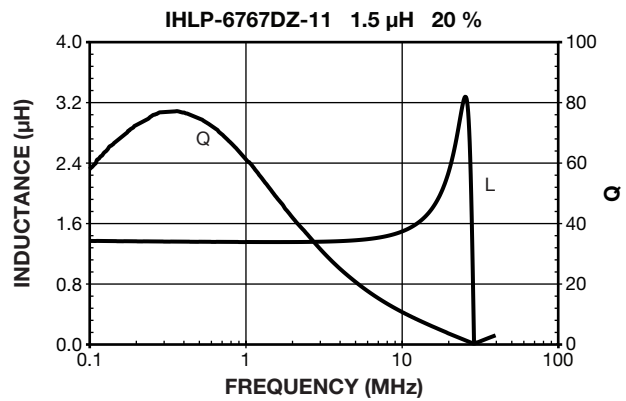
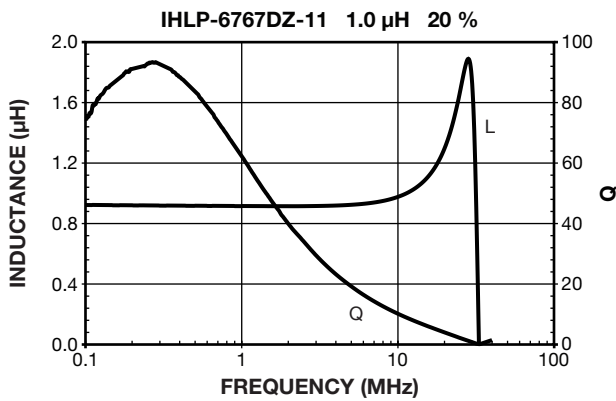



PERFORMANCE GRAPHS: INDUCTANCE AND Q VS. FREQUENCY

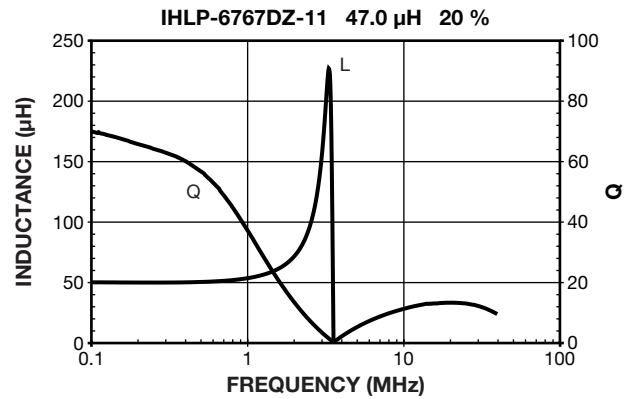
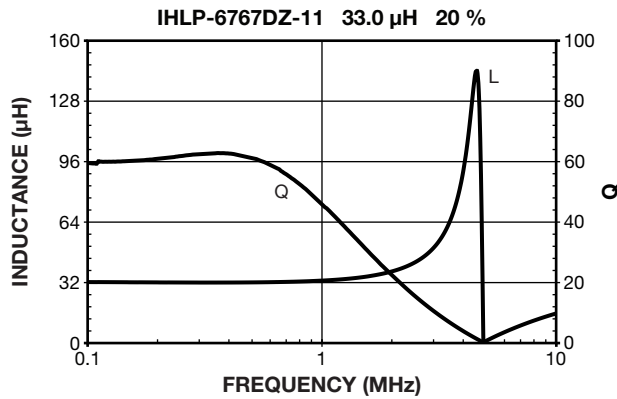
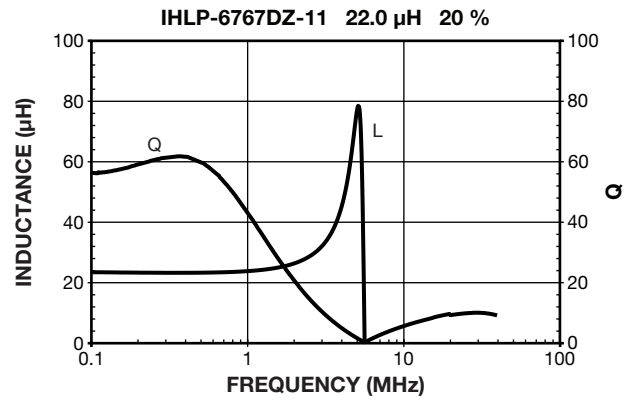
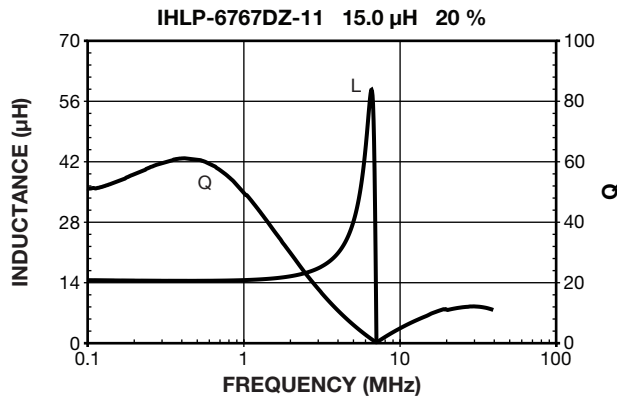

Low Profile, High Current IHLP® Inductors



Manufactured under one or more of the following:
US Patents; 6,198,375/6,204,744/6,449,829/6,460,244.
 Several foreign patents, and other patents pending.

STANDARD ELECTRICAL SPECIFICATIONS

L_0 INDUCTANCE ± 20 % AT 100 kHz, 0.25 V, 0 A (μ H)	DCR TYP. 25 °C (m Ω)	DCR MAX. 25 °C (m Ω)	HEAT RATING CURRENT DC TYP. (A) ⁽³⁾	SATURATION CURRENT DC TYP. (A) ⁽⁴⁾
0.22	0.63	0.70	80	129
0.33	0.71	0.79	65	126
0.47	0.90	0.98	62	123
0.56	0.91	1.00	56	88
0.82	1.17	1.29	50	73
1.0	1.28	1.35	48	73
1.5	1.78	1.88	42	65
1.8	1.96	2.07	38	65
2.2	2.40	2.53	35	62
3.3	3.68	3.88	28	54
4.7	4.84	5.11	25	41
5.6	6.68	7.05	21	40
6.8	8.37	8.83	19	32
8.2	10.10	10.66	18	25
10.0	11.6	12.0	16.5	25
15.0	18.8	19.9	12.5	25
22.0	25.1	26.5	11	23

Notes

- (1) All test data is referenced to 25 °C ambient
- (2) Operating temperature range - 55 °C to + 125 °C
- (3) DC current (A) that will cause an approximate ΔT of 40 °C
- (4) DC current (A) that will cause L_0 to drop approximately 20 %
- (5) The part temperature (ambient + temp. rise) should not exceed 125 °C under worst case operating conditions. Circuit design, component placement, PWB trace size and thickness, airflow and other cooling provisions all affect the part temperature. Part temperature should be verified in the end application.

FEATURES

- Shielded construction
- Frequency range up to 2.0 MHz
- Lowest DCR/ μ H, in this package size
- Handles high transient current spikes without saturation
- Saturation and inductance extremely stable over temperature
- Ultra low buzz noise, due to composite construction
- Compliant to RoHS Directive 2002/95/EC



RoHS
COMPLIANT
GREEN
[5-2008]**

APPLICATIONS

- Desktop/server applications
- High current buck and boost converters
- Low profile, high current power supplies
- DC/DC converters in distributed power systems
- High current noise filter

DIMENSIONS in inches [millimeters]

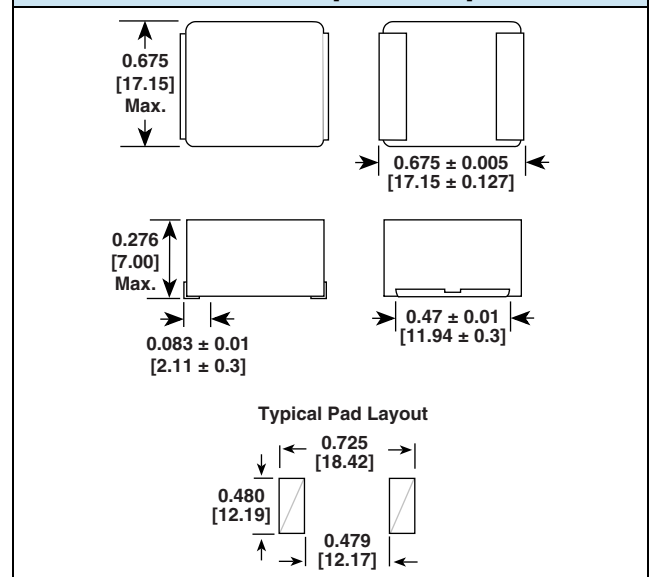

DESCRIPTION

IHLP-6767GZ-01	4.7 μH	± 20 %	ER	e3
MODEL	INDUCTANCE VALUE	INDUCTANCE TOLERANCE	PACKAGE CODE	JEDEC LEAD (Pb)-FREE STANDARD

GLOBAL PART NUMBER

I	H	L	P	6	7	6	7	G	Z	E	R	4	R	7	M	0	1
PRODUCT FAMILY				SIZE				PACKAGE CODE		INDUCTANCE VALUE			TOL.	SERIES			

** Please see document "Vishay Material Category Policy": www.vishay.com/doc?99902

PERFORMANCE GRAPHS

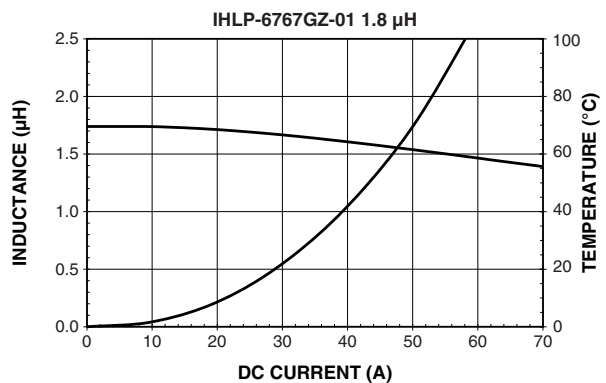
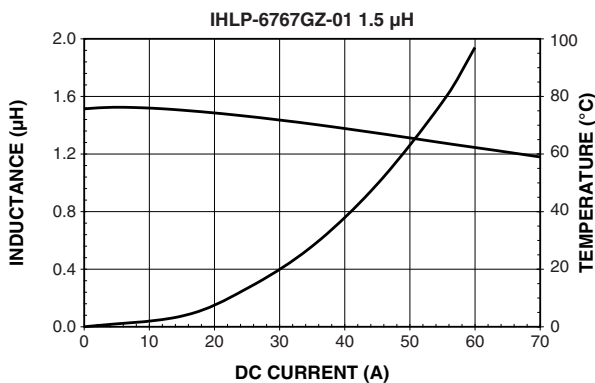
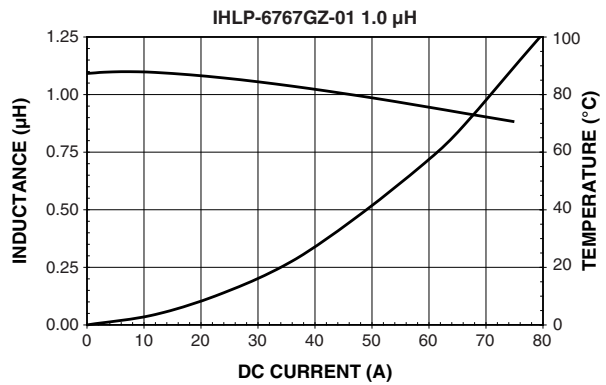
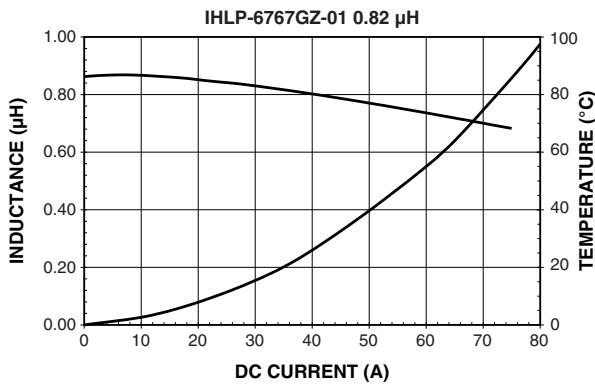
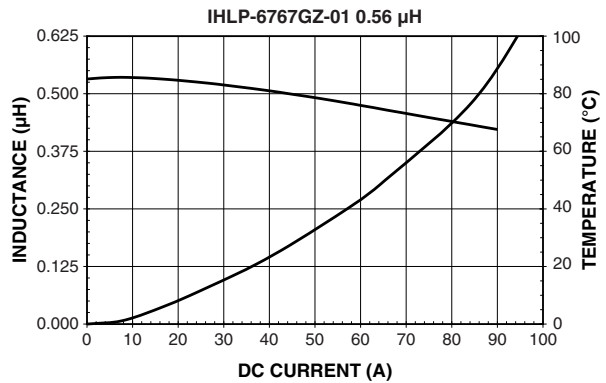
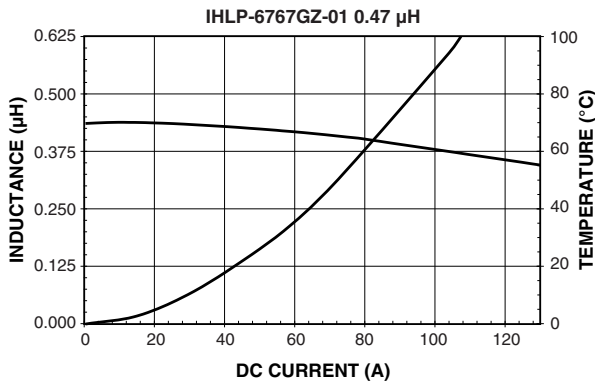
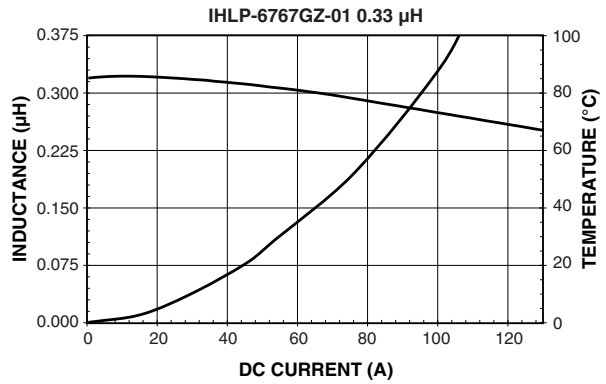
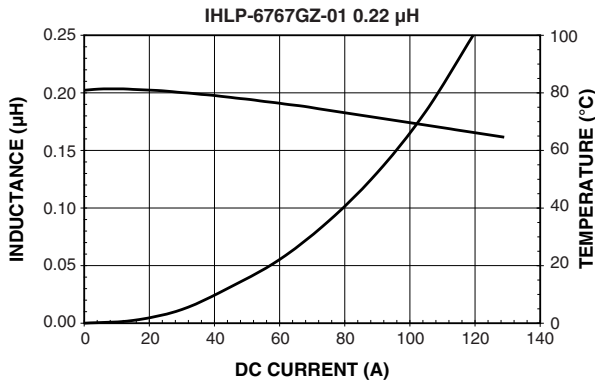



PERFORMANCE GRAPHS

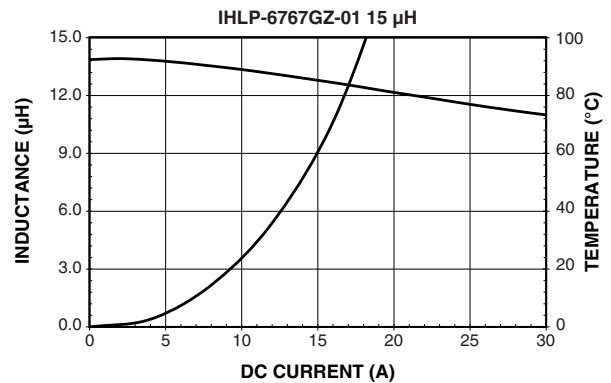
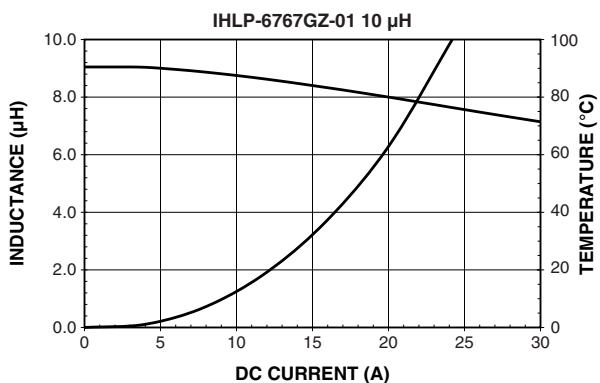
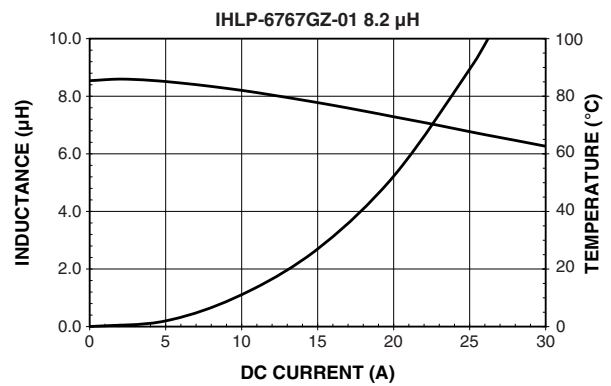
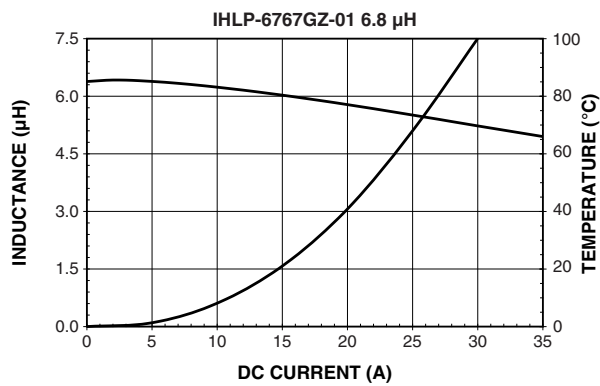
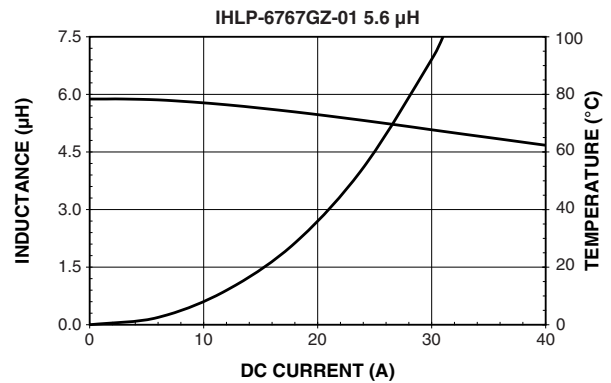
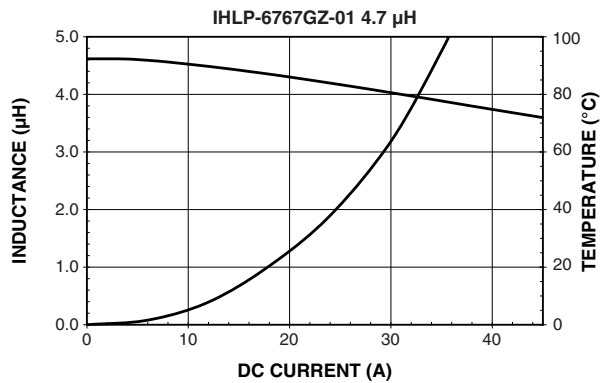
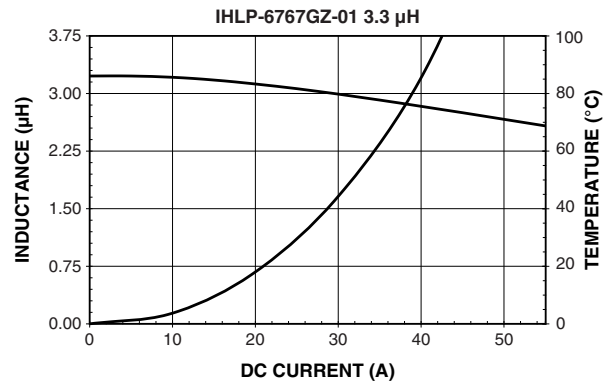
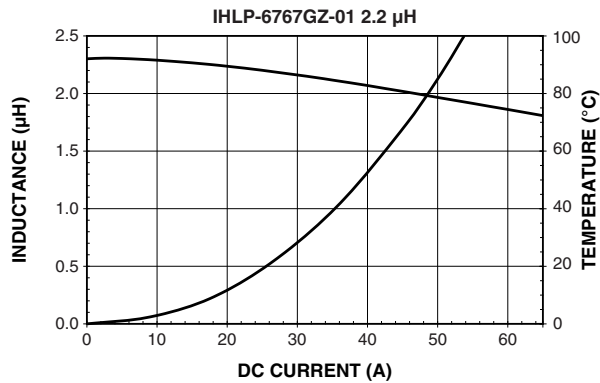

PERFORMANCE GRAPHS

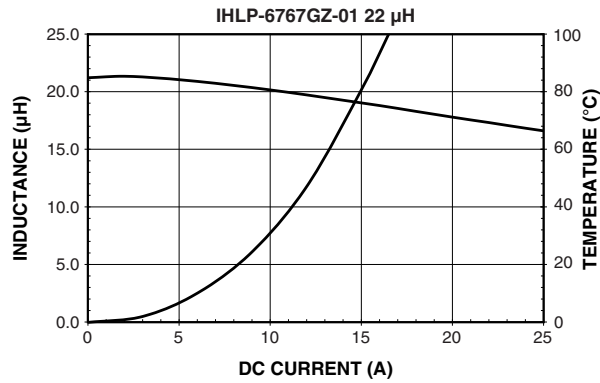

Low Profile, High Current IHLP® Inductors



Manufactured under one or more of the following:
US Patents; 6,198,375/6,204,744/6,449,829/6,460,244.
 Several foreign patents, and other patents pending.

STANDARD ELECTRICAL SPECIFICATIONS				
L ₀ INDUCTANCE ± 20 % AT 100 kHz, 0.25 V, 0 A (μH)	DCR TYP. 25 °C (mΩ)	DCR MAX. 25 °C (mΩ)	HEAT RATING CURRENT DC TYP. (A) ⁽³⁾	SATURATION CURRENT DC TYP. (A) ⁽⁴⁾
0.33	0.61	0.67	75.5	55
0.47	0.78	0.87	64.5	62
0.56	0.83	0.91	61	66
0.82	0.98	1.08	56.5	45
1.0	1.21	1.27	55.5	32
1.5	1.54	1.62	48	31
2.2	1.85	1.98	43.5	28
3.3	2.79	2.93	35	27
4.7	3.98	4.18	30	21
5.6	4.23	4.44	28	21
6.8	5.86	6.15	22.5	18.5
8.2	7.71	8.10	21	18
10.0	8.89	9.33	19	17
15.0	13.7	14.4	14	12
22.0	20.0	21.0	12	9.5
33.0	35.1	37.0	10.7	9
47.0	40.7	42.7	8.7	8.6
56.0	55	57.8	7.2	4.2
68.0	72.1	75.7	6.1	4.5
82.0	87.3	91.7	5.5	4.5
100.0	105	110	5.0	4.0

Notes

- (1) All test data is referenced to 25 °C ambient
- (2) Operating temperature range - 55 °C to + 125 °C
- (3) DC current (A) that will cause an approximate ΔT of 40 °C
- (4) DC current (A) that will cause L₀ to drop approximately 20 %
- (5) The part temperature (ambient + temp. rise) should not exceed 125 °C under worst case operating conditions. Circuit design, component placement, PWB trace size and thickness, airflow and other cooling provisions all affect the part temperature. Part temperature should be verified in the end application.

FEATURES

- Shielded construction
- Frequency range up to 750 kHz
- Lowest DCR/μH, in this package size
- Handles high transient current spikes without saturation
- Ultra low buzz noise, due to composite construction
- Compliant to RoHS Directive 2002/95/EC
- Halogen-free according to IEC 61249-2-21 definition



RoHS
 COMPLIANT
 HALOGEN
FREE

APPLICATIONS

- PDA/notebook/desktop/server applications
- High current POL converters
- Low profile, high current power supplies
- Battery powered devices
- DC/DC converters in distributed power systems
- DC/DC converter for Field Programmable Gate Array (FPGA)

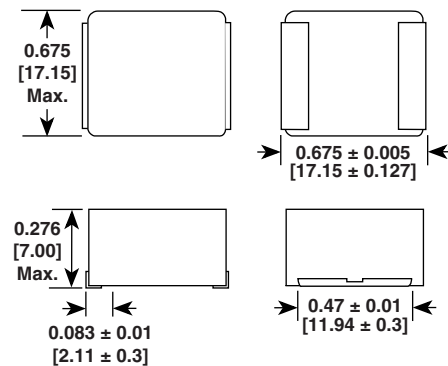
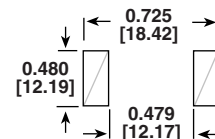
DIMENSIONS in inches [millimeters]

Typical Pad Layout

DESCRIPTION

IHLP-6767GZ-11	4.7 μH	± 20 %	ER	e3
MODEL	INDUCTANCE VALUE	INDUCTANCE TOLERANCE	PACKAGE CODE	JEDEC LEAD (Pb)-FREE STANDARD

GLOBAL PART NUMBER

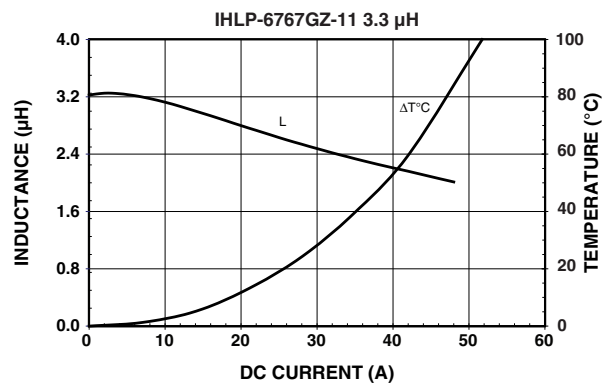
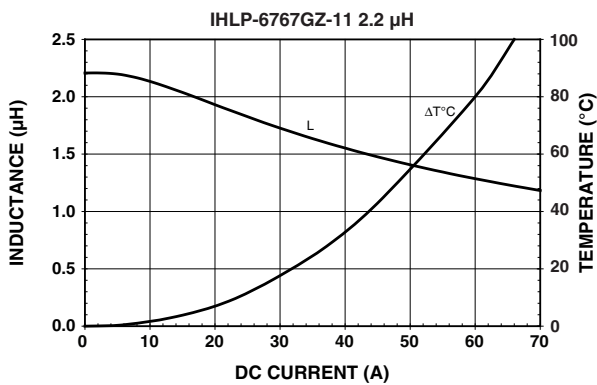
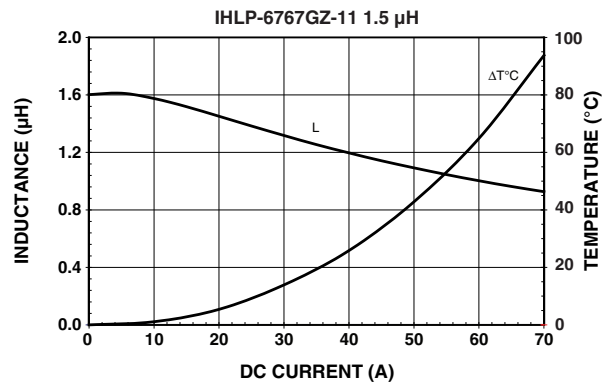
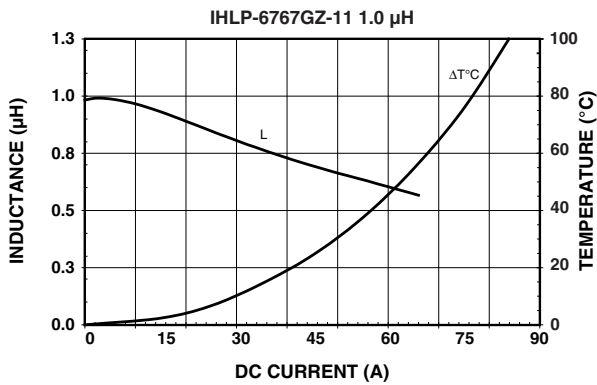
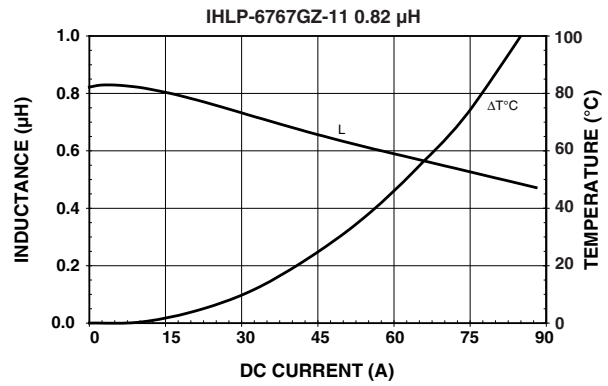
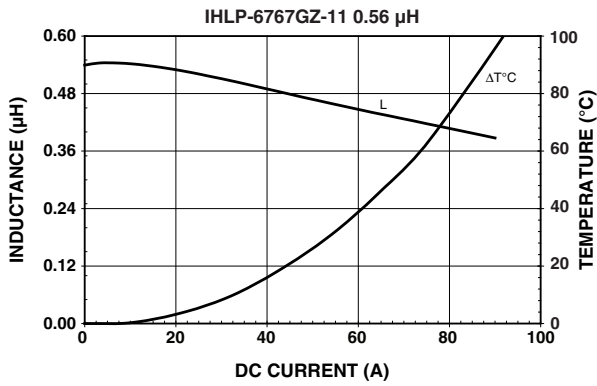
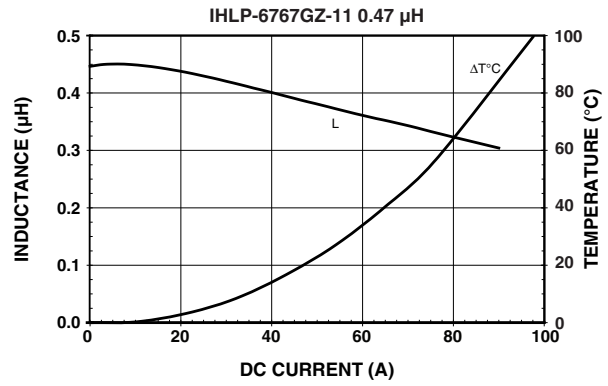
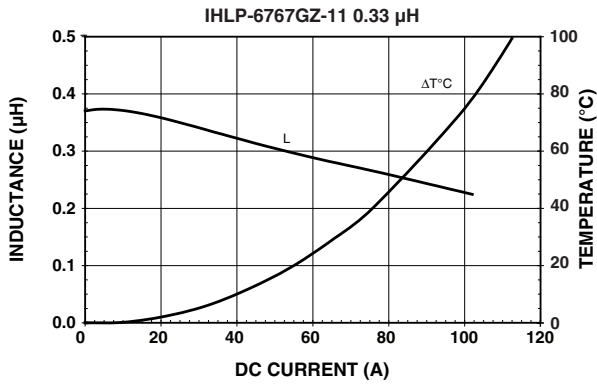
I	H	L	P	6	7	6	7	G	Z	E	R	4	R	7	M	1	1
PRODUCT FAMILY				SIZE				PACKAGE CODE		INDUCTANCE VALUE			TOL.		SERIES		

PERFORMANCE GRAPHS





PERFORMANCE GRAPHS

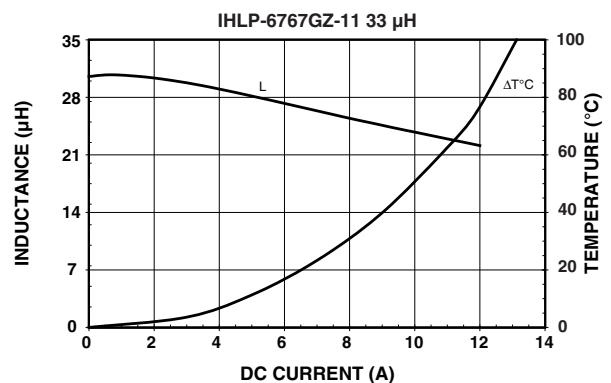
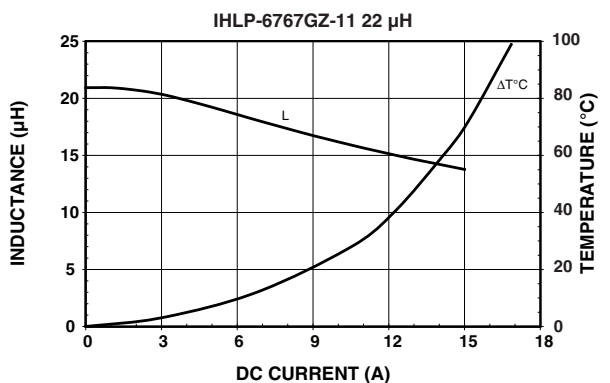
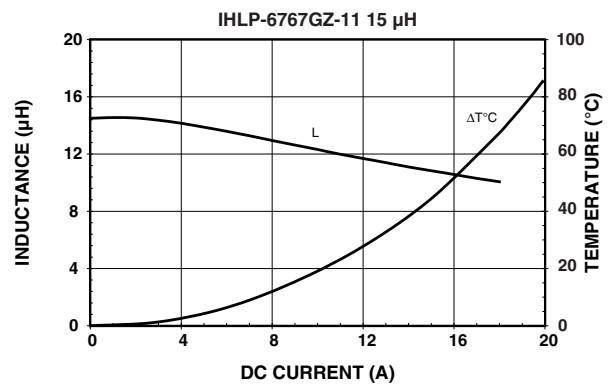
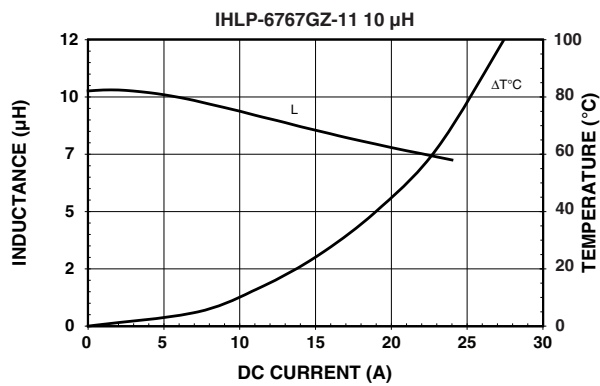
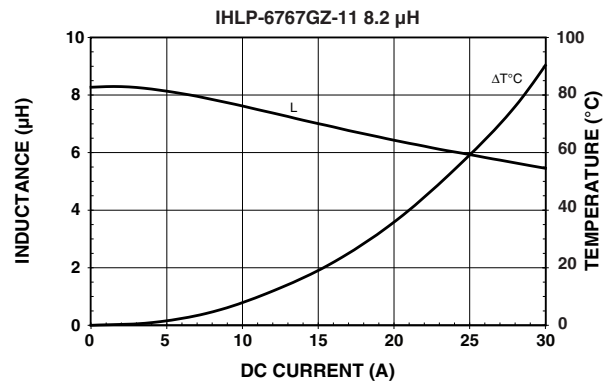
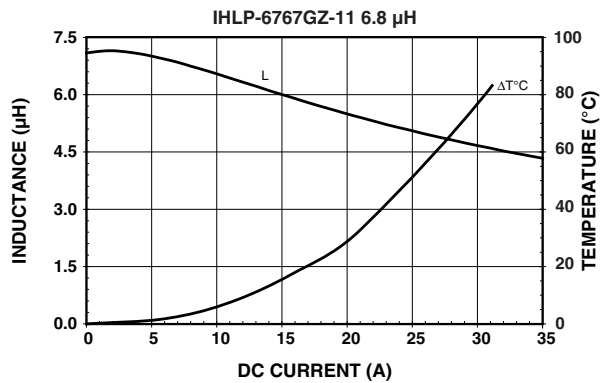
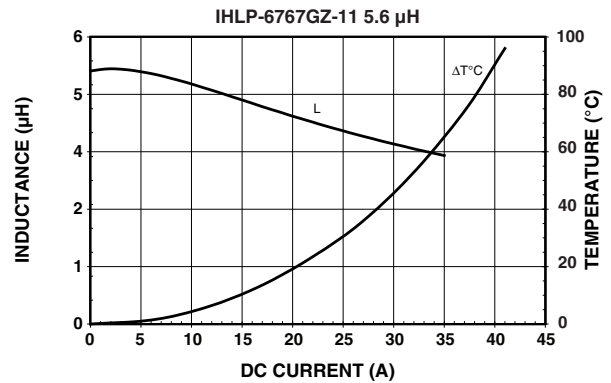
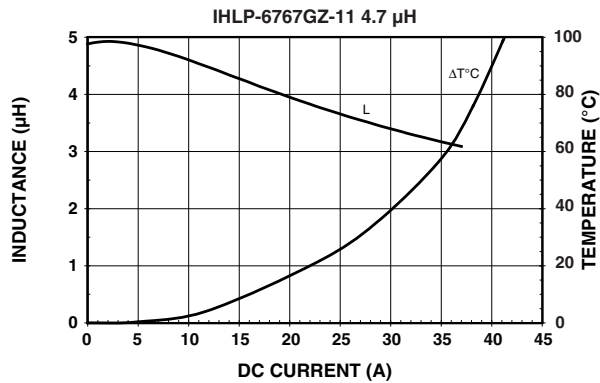

PERFORMANCE GRAPHS

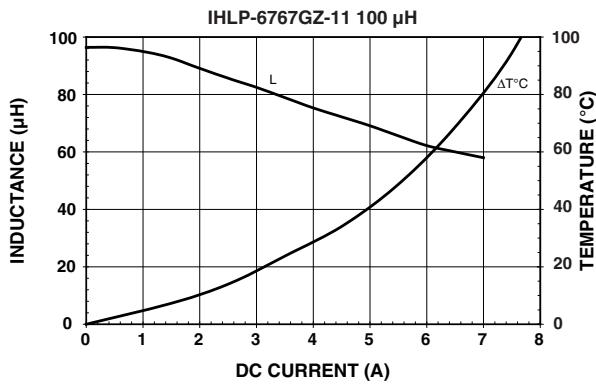
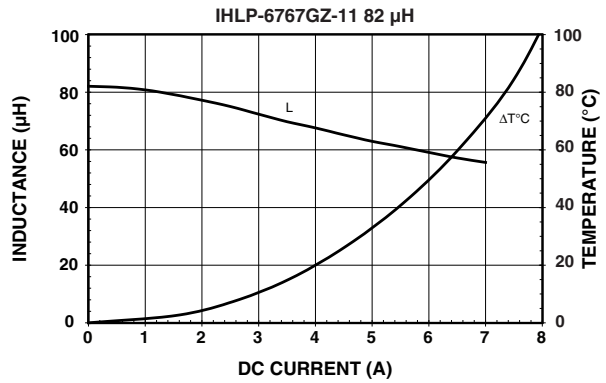
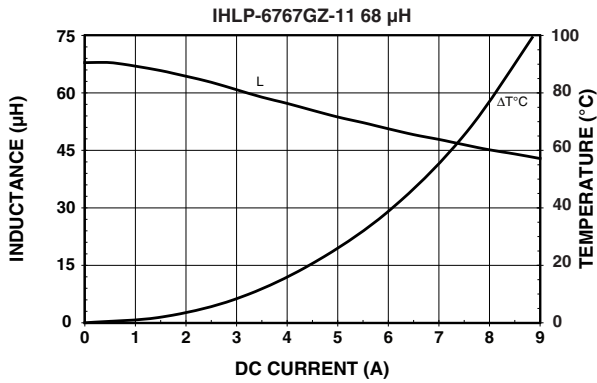
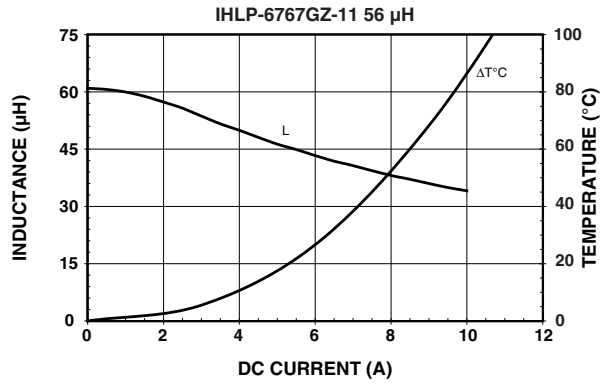
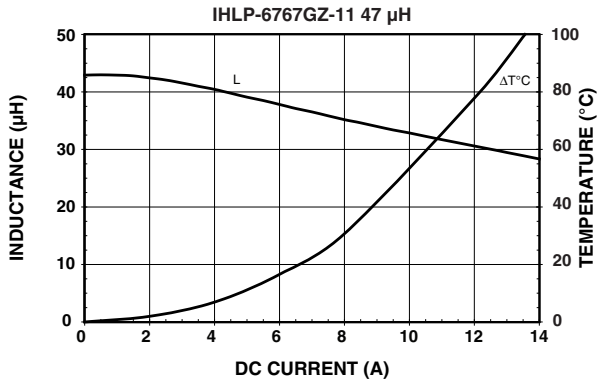

Low Profile, High Current IHLP® Inductors



Manufactured under one or more of the following:
US Patents; 6,198,375/6,204,744/6,449,829/6,460,244.
 Several foreign patents, and other patents pending.

FEATURES

- High temperature rating, up to 155 °C
- Shielded construction
- Frequency range up to 750 kHz
- Lowest DCR/ μ H, in this package size
- Handles high transient current spikes without saturation
- Ultra low buzz noise, due to composite construction
- Compliant to RoHS Directive 2002/95/EC



RoHS
COMPLIANT

APPLICATIONS

- PDA/notebook/desktop/server applications
- High current POL converters
- Low profile, high current power supplies
- Battery powered devices
- DC/DC converters in distributed power systems
- DC/DC converter for Field Programmable Gate Array (FPGA)

STANDARD ELECTRICAL SPECIFICATIONS				
L_0 INDUCTANCE $\pm 20\%$ AT 100 kHz, 0.25 V, 0 A (μ H)	DCR TYP. 25 °C (m Ω)	DCR MAX. 25 °C (m Ω)	HEAT RATING CURRENT DC TYP. (A) ⁽³⁾	SATURATION CURRENT DC TYP. (A) ⁽⁴⁾
0.47	0.89	0.95	63.0	87.0
1.0	1.36	1.46	53.0	42.0
2.2	2.25	2.41	38.5	38.0
3.3	3.06	3.27	32.2	32.0
4.7	4.89	5.23	24.0	26.0
10.0	10.20	10.91	16.0	20.0
15.0	15.85	16.96	12.5	13.0
22.0	21.28	22.27	11.7	11.0

Notes

- (1) All test data is referenced to 25 °C ambient
- (2) Operating temperature range - 55 °C to + 155 °C
- (3) DC current (A) that will cause an approximate ΔT of 40 °C
- (4) DC current (A) that will cause L_0 to drop approximately 20 %
- (5) The part temperature (ambient + temp. rise) should not exceed 155 °C under worst case operating conditions. Circuit design, component placement, PWB trace size and thickness, airflow and other cooling provisions all affect the part temperature. Part temperature should be verified in the end application.

DIMENSIONS in inches [millimeters]

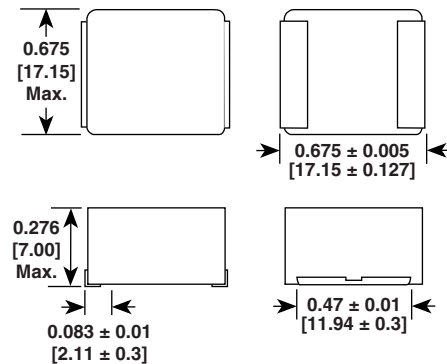

Typical Pad Layout

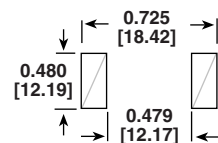

DESCRIPTION

IHLP-6767GZ-51	2.2 μH	$\pm 20\%$	ER	e3
MODEL	INDUCTANCE VALUE	INDUCTANCE TOLERANCE	PACKAGE CODE	JEDEC LEAD (Pb)-FREE STANDARD

GLOBAL PART NUMBER

I	H	L	P	6	7	6	7	G	Z	E	R	2	R	2	M	5	1
PRODUCT FAMILY				SIZE				PACKAGE CODE		INDUCTANCE VALUE		TOL.	SERIES				

PERFORMANCE GRAPHS

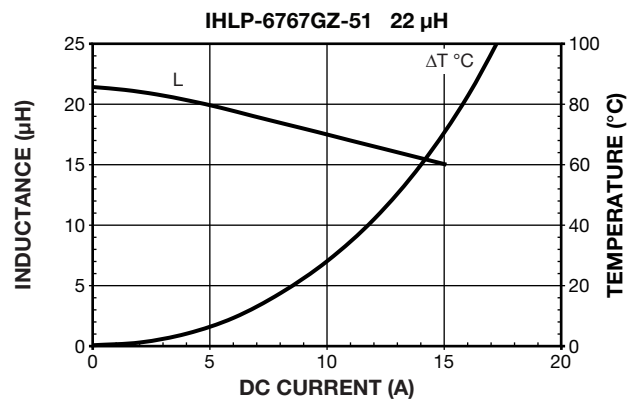
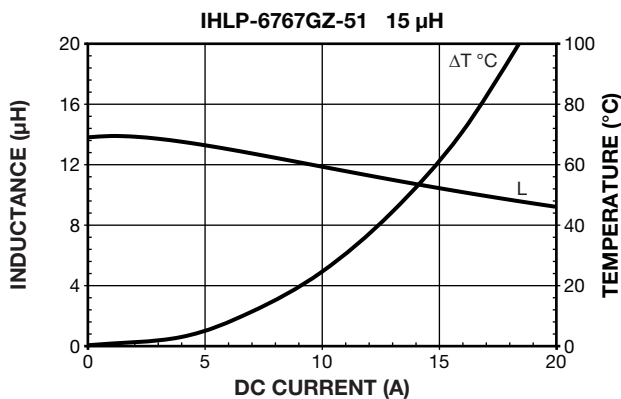
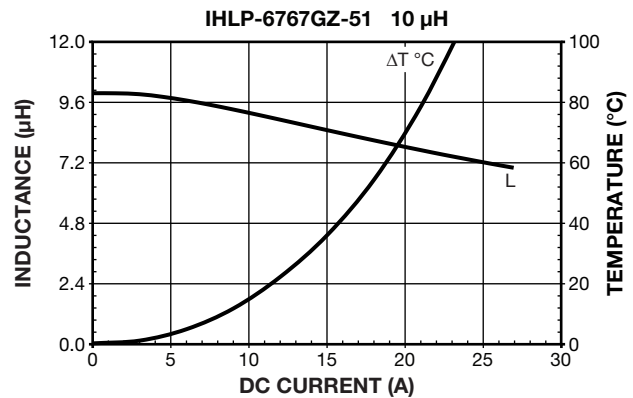
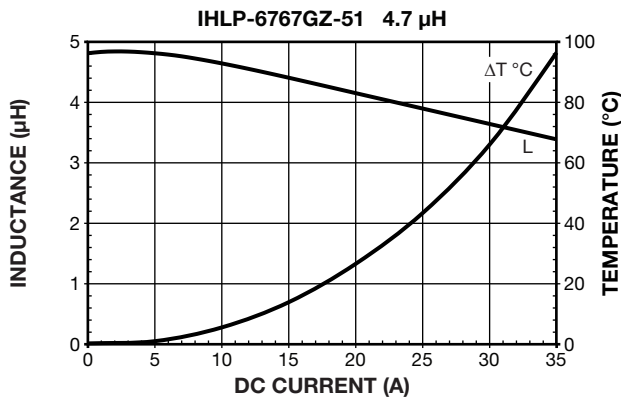
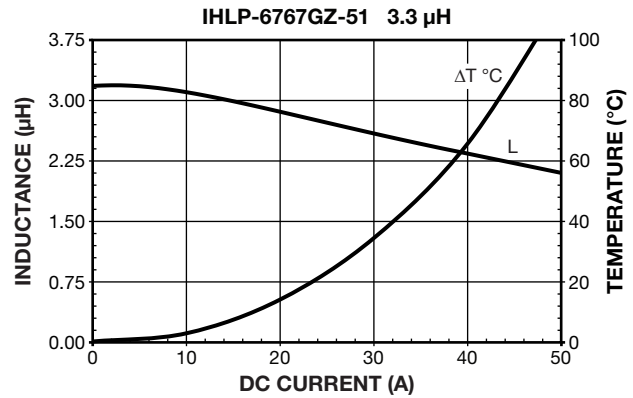
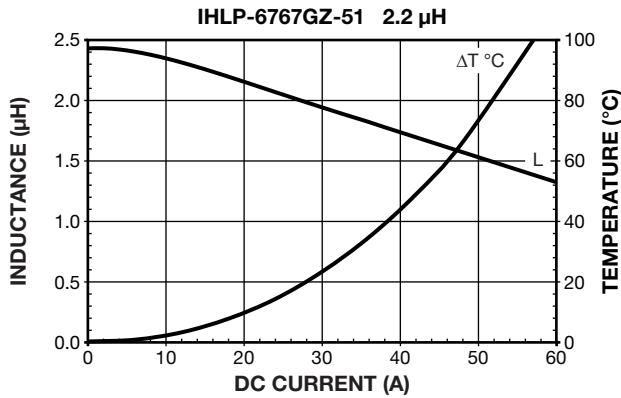
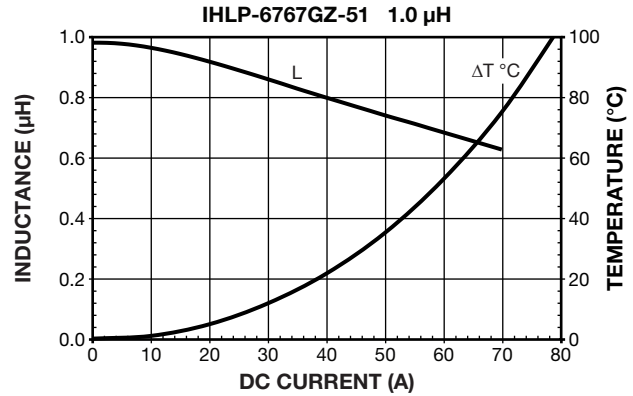
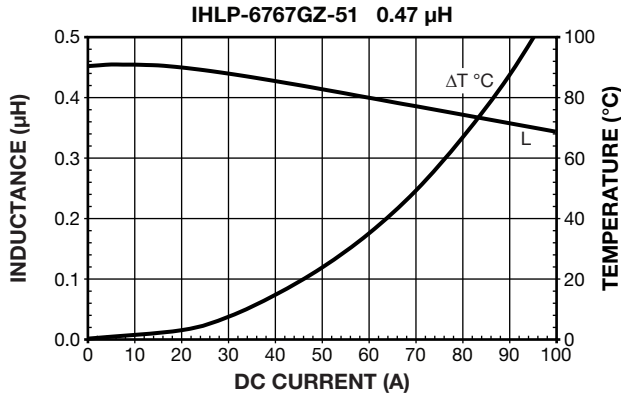

PERFORMANCE GRAPHS: INDUCTANCE AND Q VS. FREQUENCY

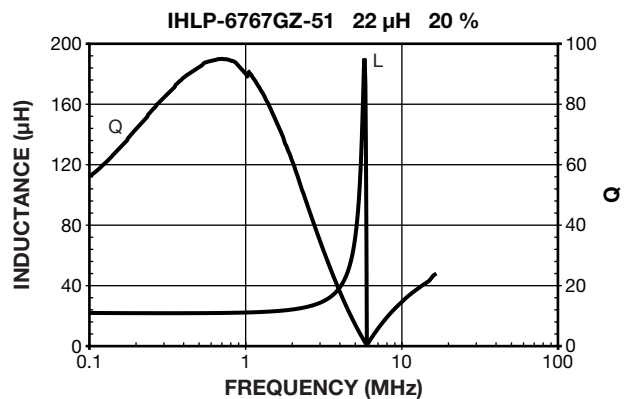
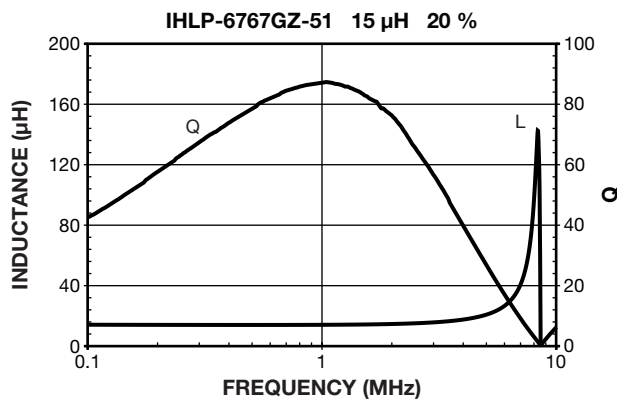
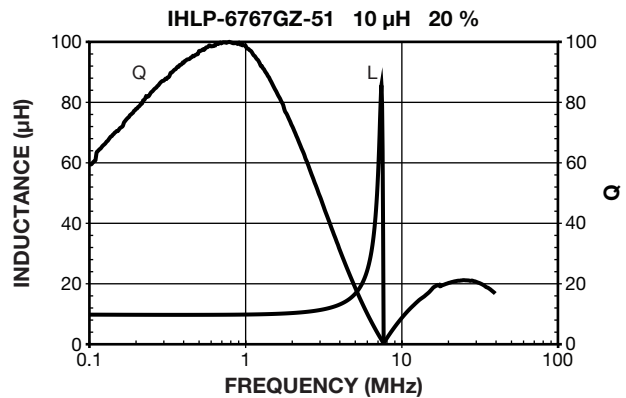
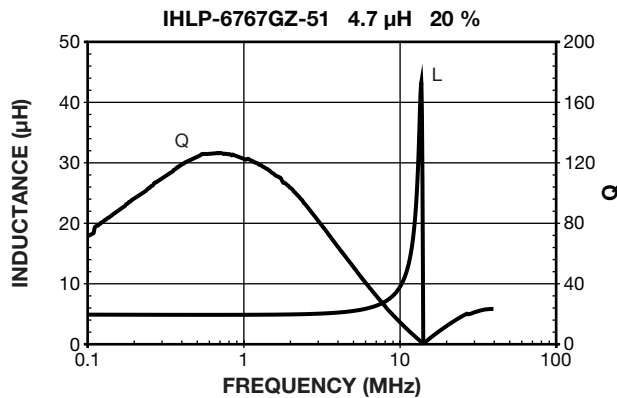
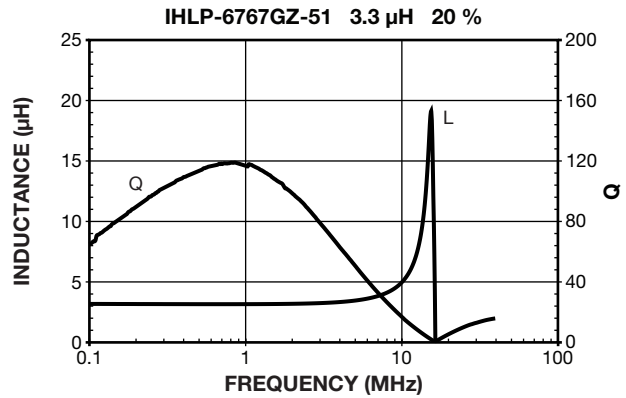
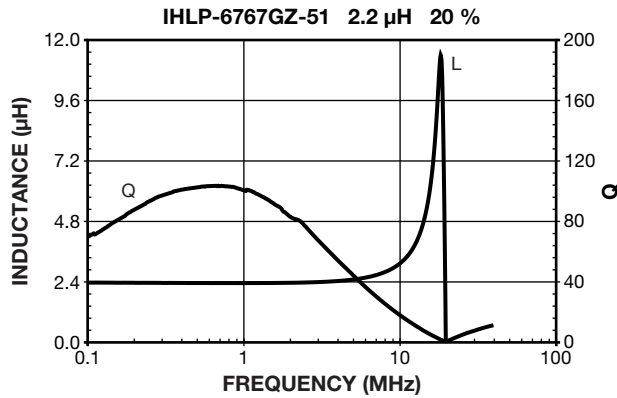
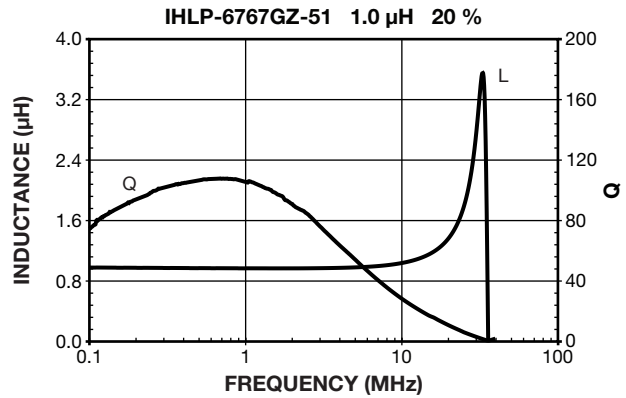
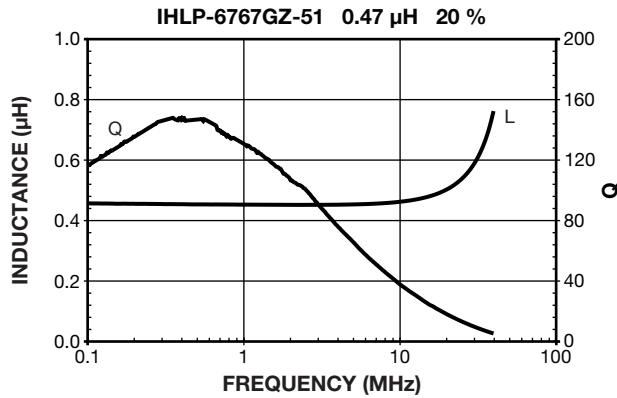

Low Profile, High Current Inductor

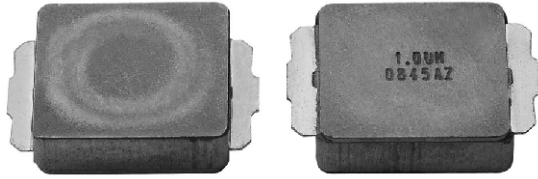

Manufactured under one or more of the following:
US Patents; 6,198,375/6,204,744/6,449,829/6,460,244.
 Several foreign patents, and other patents pending.

STANDARD ELECTRICAL SPECIFICATIONS				
L_0 INDUCTANCE $\pm 20\%$ AT 100 kHz, 0.25 V, 0 A (μH)	DCR TYP. 25 °C (m Ω)	DCR MAX. 25 °C (m Ω)	HEAT RATING CURRENT DC TYP. (A) ⁽³⁾	SATURATION CURRENT DC TYP. (A) ⁽⁴⁾
0.10	0.70	0.80	46	48
0.15	0.79	0.85	45	46
0.22	0.83	0.90	35.5	36
0.33	1.09	1.18	33.5	33.5
0.47	1.60	1.69	31	22
0.56	1.71	1.81	30.5	23
0.68	2.05	2.16	29	20
0.82	2.46	2.60	24	19
1.0	2.67	2.82	24	18
1.5	4.20	4.43	20	14.5
2.2	6.83	7.21	16	14

Notes

- (1) All test data is referenced to 25 °C ambient
- (2) Operating temperature range - 55 °C to + 125 °C
- (3) DC current (A) that will cause an approximate ΔT of 40 °C
- (4) DC current (A) that will cause L_0 to drop approximately 20 %
- (5) The part temperature (ambient + temp. rise) should not exceed 125 °C under worst case operating conditions. Circuit design, component placement, PWB trace size and thickness, airflow and other cooling provisions all affect the part temperature. Part temperature should be verified in the end application.

FEATURES

- Shielded construction
- Frequency range up to 1.0 MHz
- Lowest DCR/ μH , in this package size
- Handles high transient current spikes without saturation
- Ultra low buzz noise, due to composite construction
- Compliant to RoHS Directive 2002/95/EC
- Halogen-free according to IEC 61249-2-21 definition



RoHS
 COMPLIANT
 HALOGEN
FREE

APPLICATIONS

- PDA/notebook/desktop/server applications
- High current POL converters
- Low profile, high current power supplies
- Battery powered devices
- DC/DC converters in distributed power systems
- DC/DC converter for Field Programmable Gate Array (FPGA)

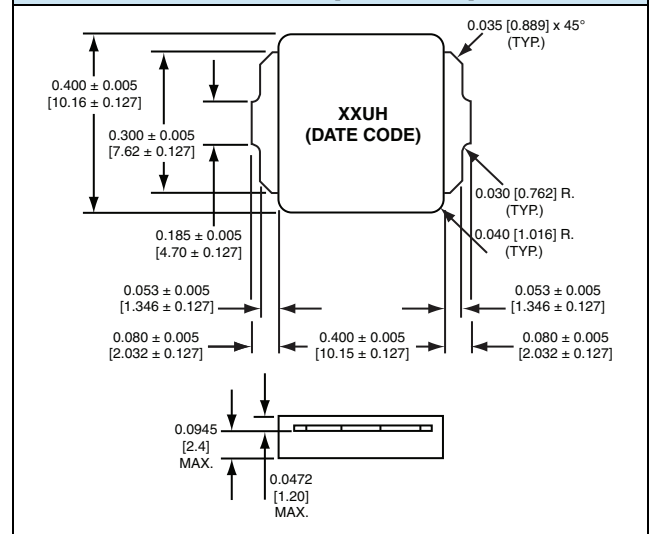
DIMENSIONS in inches [millimeters]

DESCRIPTION

IHLW-4040CF-11	1.0 μH	$\pm 20\%$	ER	e3
MODEL	INDUCTANCE VALUE	INDUCTANCE TOLERANCE	PACKAGE CODE	JEDEC LEAD (Pb)-FREE STANDARD

GLOBAL PART NUMBER

I	H	L	W	4	0	4	0	C	F	E	R	1	R	0	M	1	1
PRODUCT FAMILY				SIZE				PACKAGE CODE		INDUCTANCE VALUE		TOL.	SERIES				



PERFORMANCE GRAPHS

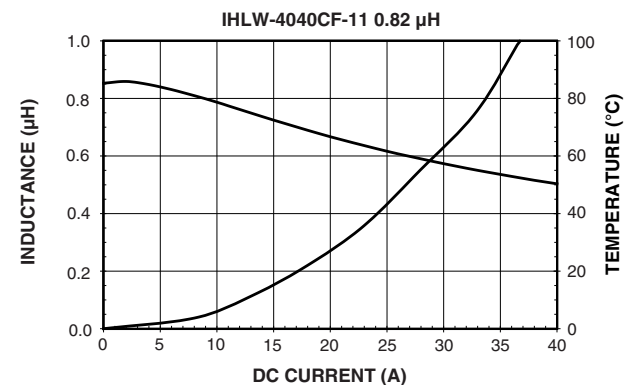
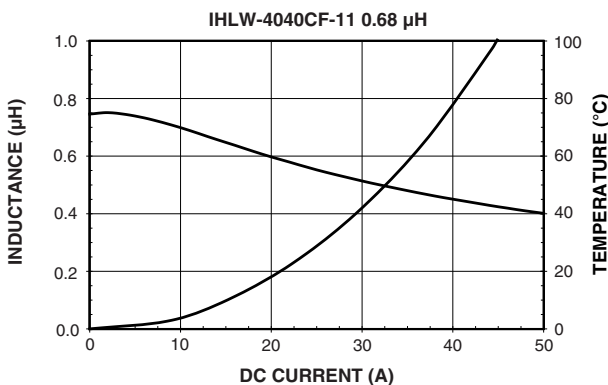
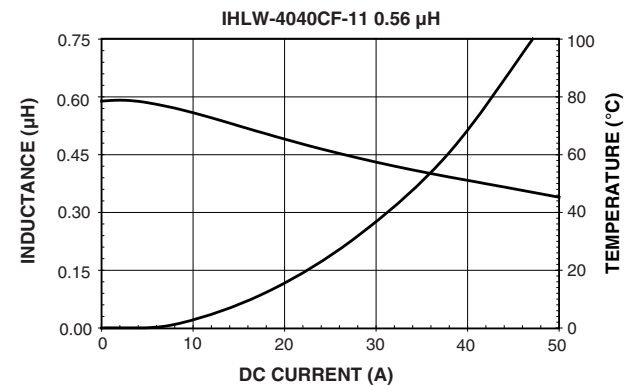
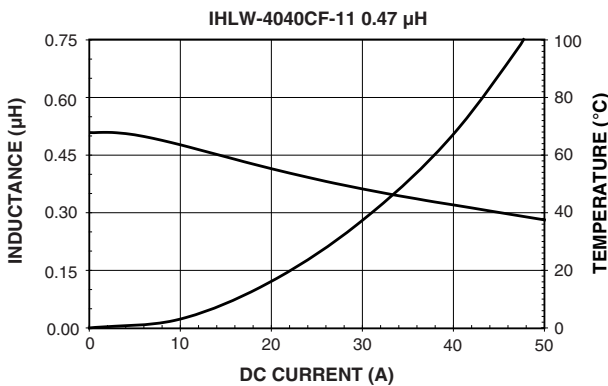
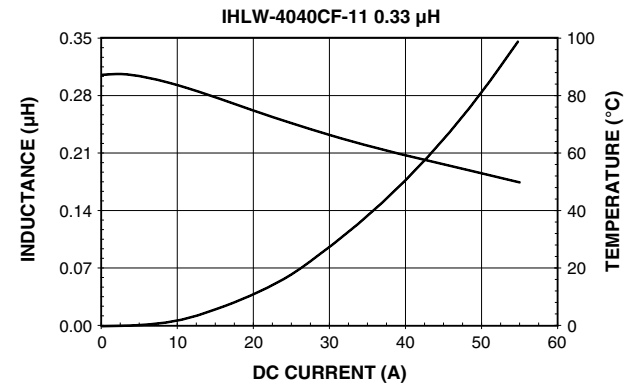
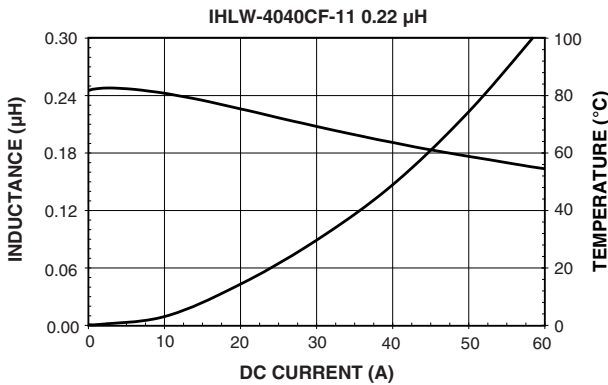
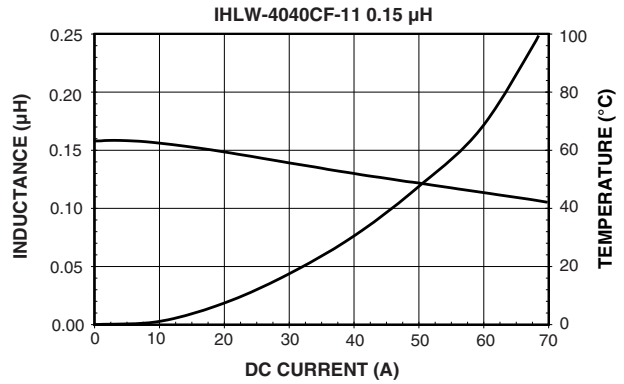
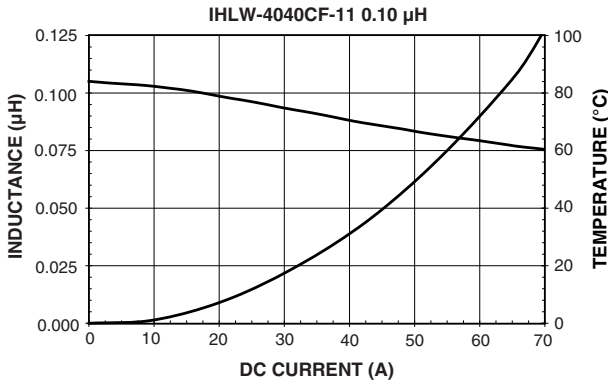



PERFORMANCE GRAPHS

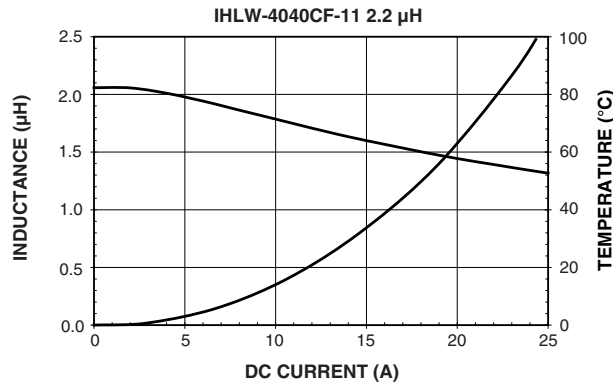
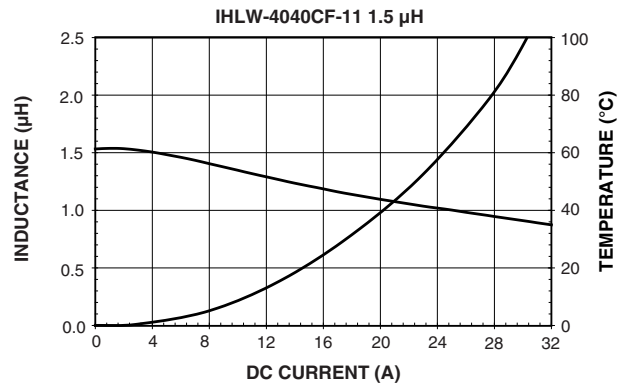
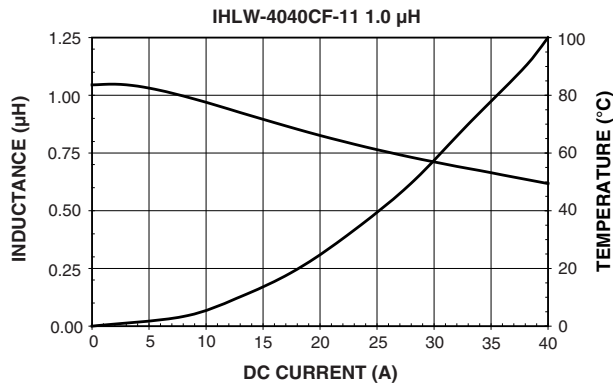

Low Profile, High Current Inductors

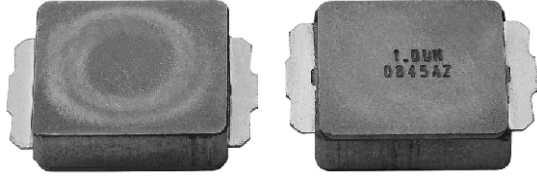

Manufactured under one or more of the following:
US Patents; 6,198,375/6,204,744/6,449,829/6,460,244.
 Several foreign patents, and other patents pending.

STANDARD ELECTRICAL SPECIFICATIONS				
L_0 INDUCTANCE ± 20 % AT 100 kHz, 0.25 V, 0 A (µH)	DCR TYP. 25 °C (mΩ)	DCR MAX. 25 °C (mΩ)	HEAT RATING CURRENT DC TYP. (A) ⁽³⁾	SATURATION CURRENT DC TYP. (A) ⁽⁴⁾
0.10	0.8	0.96	43	84
0.15	1	1.2	41	75
0.22	1.1	1.3	38.5	65
0.33	1.3	1.5	36.5	62
0.47	1.6	2	32	55
0.68	2.3	2.5	28	49
0.82	2.6	3	25	44
1.0	3.3	3.5	24	40
1.5	5.1	5.5	19	35
1.8	6.5	7	16.5	30
2.2	7.2	8	16	29
3.3	11	12	12	27
4.7	14.3	15	10	24
5.6	18.3	19	9.5	19
6.8	19.8	22	9	18
8.2	24.8	28	8.5	16
10	30.4	34	7	14

Notes

- (1) All test data is referenced to 25 °C ambient
- (2) Operating temperature range - 55 °C to + 125 °C
- (3) DC current (A) that will cause an approximate ΔT of 40 °C
- (4) DC current (A) that will cause L_0 to drop approximately 20 %
- (5) The part temperature (ambient + temp. rise) should not exceed 125 °C under worst case operating conditions. Circuit design, component placement, PWB trace size and thickness, airflow and other cooling provisions all affect the part temperature. Part temperature should be verified in the end application.

FEATURES

- Shielded construction
- Frequency range up to 5.0 MHz
- Lowest DCR/µH, in this package size
- Handles high transient current spikes without saturation
- Ultra low buzz noise, due to composite construction
- Compliant to RoHS Directive 2002/95/EC

RoHS
 COMPLIANT

GREEN
 (5-2008)**

APPLICATIONS

- PDA/notebook/desktop/server applications
- High current POL converters
- Low profile, high current power supplies
- Battery powered devices
- DC/DC converters in distributed power systems
- DC/DC converter for Field Programmable Gate Array (FPGA)

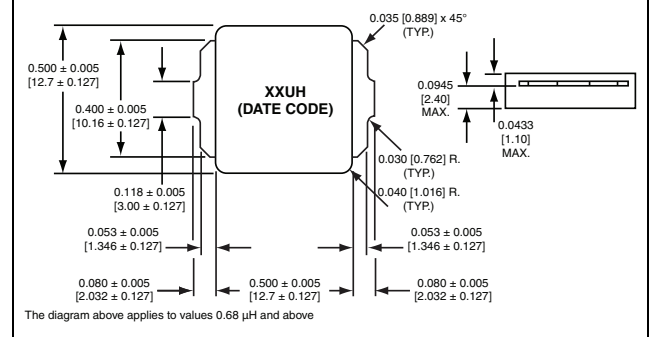
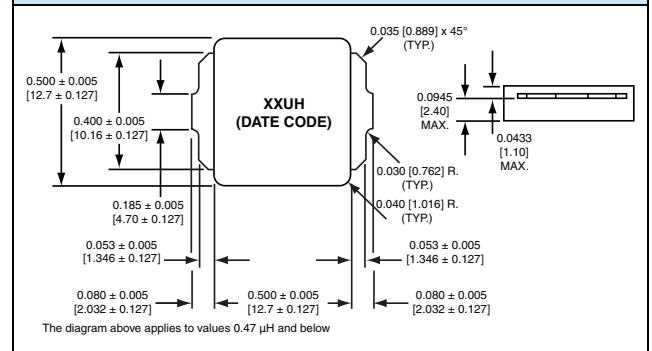
DIMENSIONS in inches [millimeters]

DESCRIPTION

IHLW-5050CE-01	1.0 µH	± 20 %	ER	e3
MODEL	INDUCTANCE VALUE	INDUCTANCE TOLERANCE	PACKAGE CODE	JEDEC LEAD (Pb)-FREE STANDARD

GLOBAL PART NUMBER

I	H	L	W	5	0	5	0	C	E	E	R	1	R	0	M	0	1
PRODUCT FAMILY				SIZE				PACKAGE CODE		INDUCTANCE VALUE		TOL.	SERIES				

** Please see document "Vishay Material Category Policy": www.vishay.com/doc?99902

PERFORMANCE GRAPHS

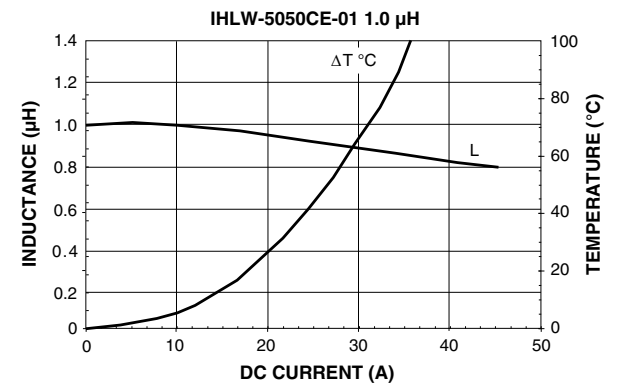
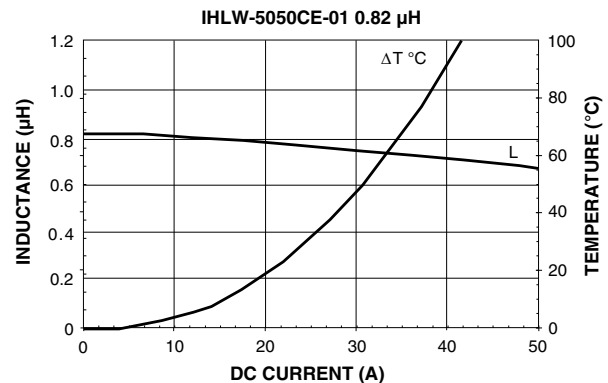
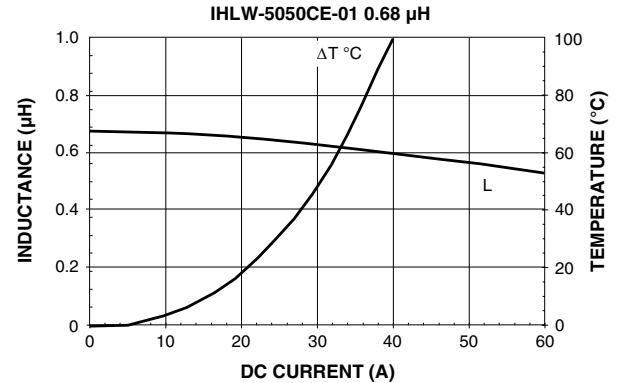
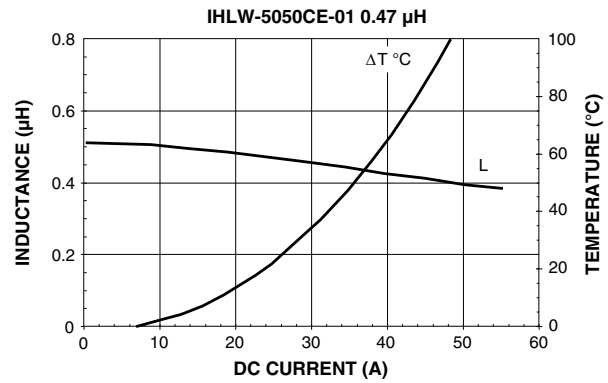
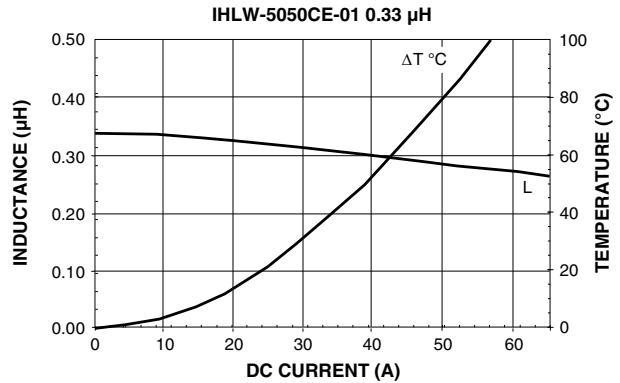
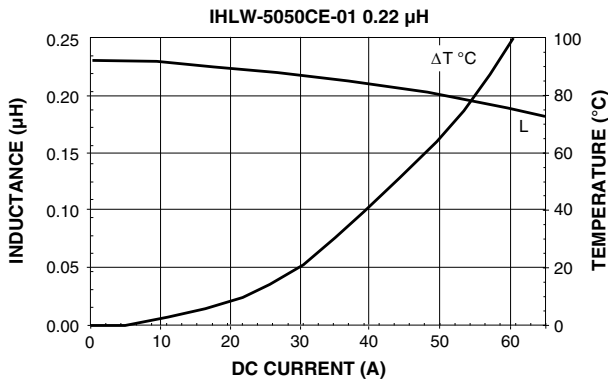
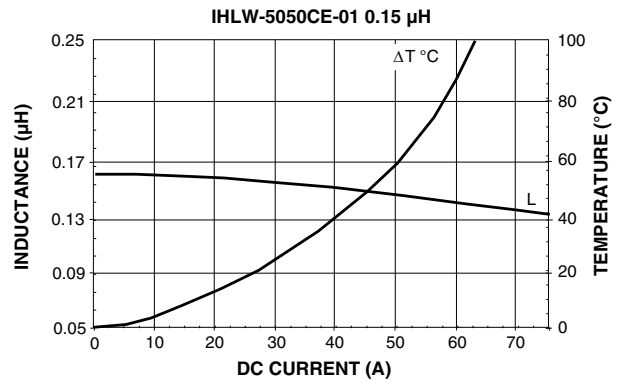
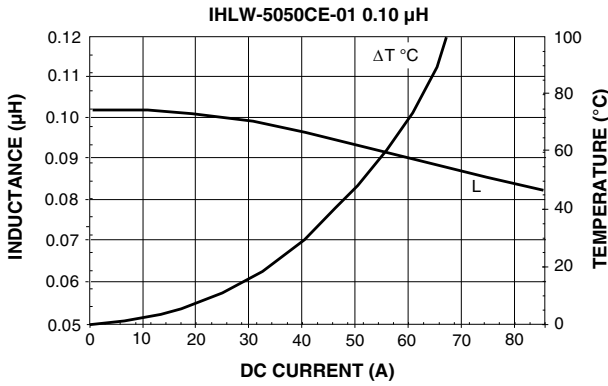

PERFORMANCE GRAPHS

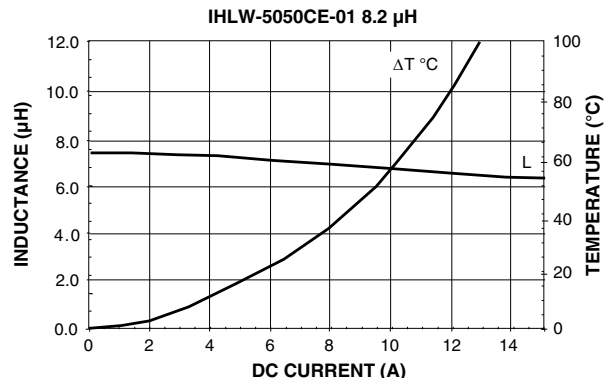
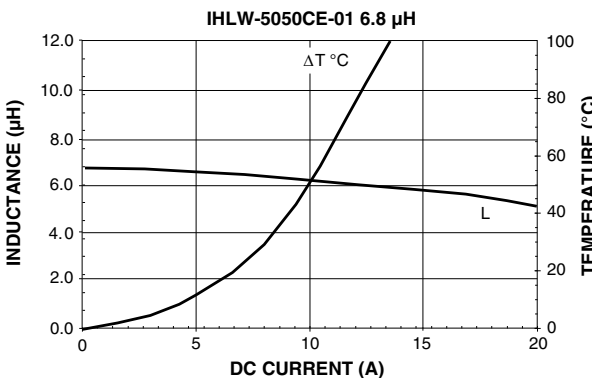
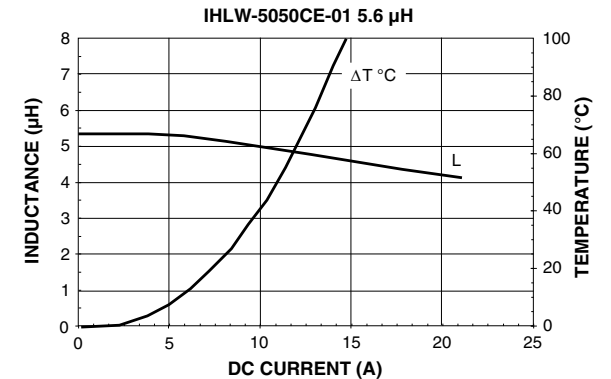
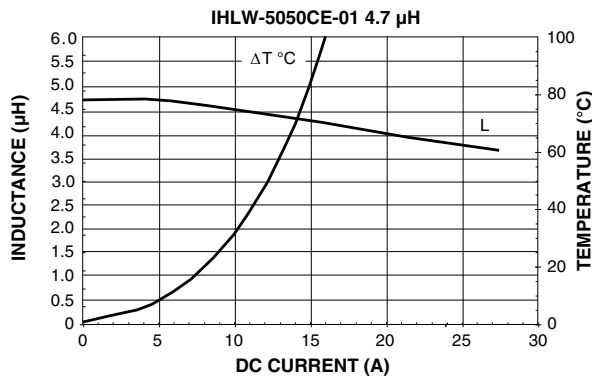
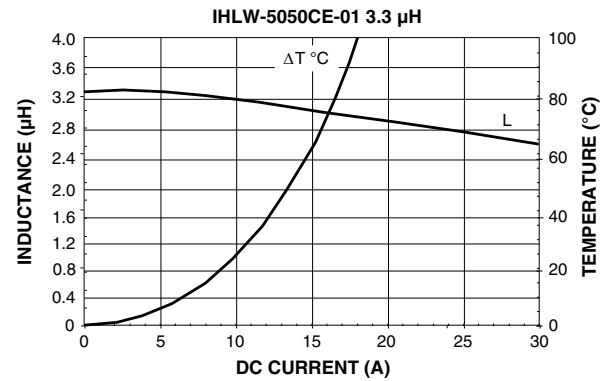
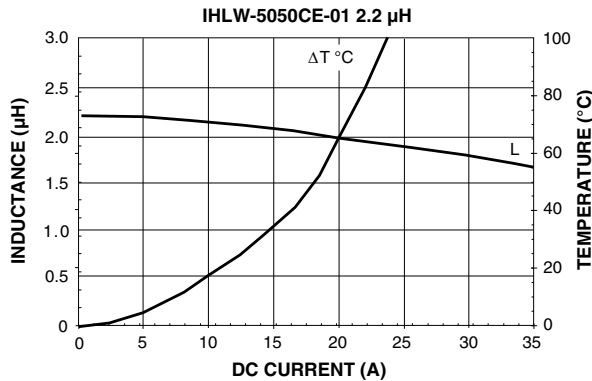
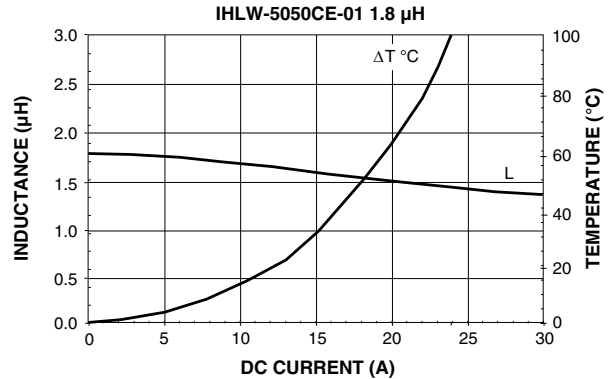
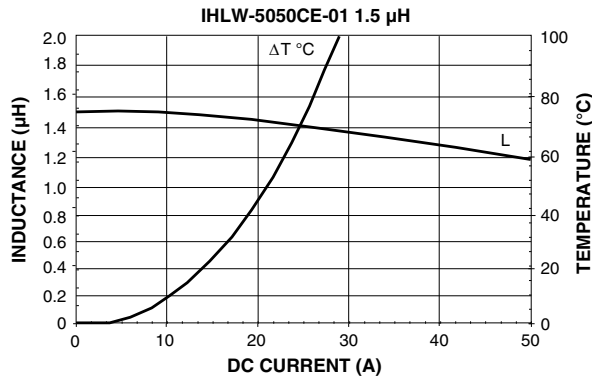



PERFORMANCE GRAPHS

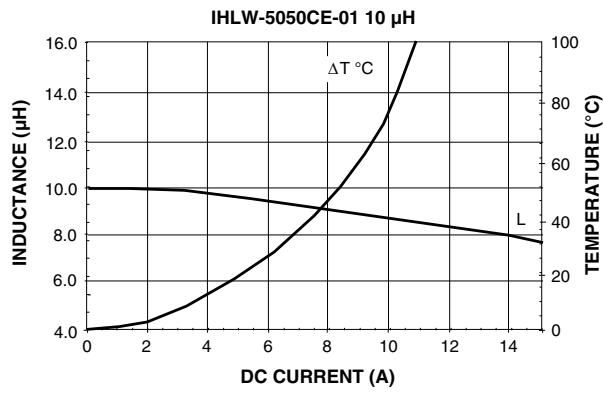

Molded, Low Profile, High Current Inductors

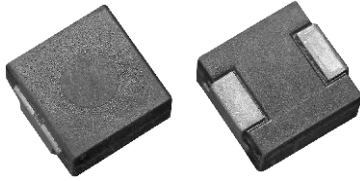

Manufactured under one or more of the following:
US Patents; 6,198,375/6,204,744/6,449,829/6,460,244.
 Several foreign patents, and other patents pending.

STANDARD ELECTRICAL SPECIFICATIONS				
L ₀ INDUCTANCE ± 20 % AT 100 kHz, 0.25 V, 0 A (μH)	DCR TYP. 25 °C (mΩ)	DCR MAX. 25 °C (mΩ)	HEAT RATING CURRENT DC TYP. (A) ⁽³⁾	SATURATION CURRENT DC TYP. (A) ⁽⁴⁾
0.10	1.5	1.7	32.5	60
0.15	1.9	2.5	26	52
0.20	2.4	3.0	24	41
0.22	2.5	2.8	23	40
0.33	3.5	3.9	20	30
0.47	4	4.2	17.5	26
0.68	5	5.5	15.5	25
0.82	6.7	8	13	24
1.0	9	10	11	22
1.5	14	15	9	18
2.2	18	20	8	14
3.3	28	30	6	13.5
4.7	37	40	5.5	10
6.8	54	60	4.5	8
8.2	64	68	4	7.5
10	102	105	3	7.0

Notes

- (1) All test data is referenced to 25 °C ambient
- (2) Operating temperature range - 55 °C to + 125 °C
- (3) DC current (A) that will cause an approximate ΔT of 40 °C
- (4) DC current (A) that will cause L₀ to drop approximately 20 %
- (5) The part temperature (ambient + temp. rise) should not exceed 125 °C under worst case operating conditions. Circuit design, component placement, PWB trace size and thickness, airflow and other cooling provisions all affect the part temperature. Part temperature should be verified in the end application.

DESCRIPTION				
IHLM-2525CZ-01	1.0 μH	± 20 %	ER	e3
MODEL	INDUCTANCE VALUE	INDUCTANCE TOLERANCE	PACKAGE CODE	JEDEC LEAD (Pb)-FREE STANDARD

GLOBAL PART NUMBER											
I	H	L	M	2	5	2	5	C	Z	E R 1 R 0 M 0 1	
PRODUCT FAMILY				SIZE				PACKAGE CODE	INDUCTANCE VALUE	TOL.	SERIES

FEATURES

- Lowest molded height (3.0 mm) in this package footprint
- Shielded construction
- Frequency range up to 5.0 MHz
- Lowest DCR/μH, in this package size
- Handles high transient current spikes without saturation
- Ultra low buzz noise, due to composite construction
- Encapsulated body offers improved environmental protection and moisture resistance
- Higher dielectric withstanding voltage vs. IHLP
- Flame retardant encapsulant (UL 94 V-0)
- Corrosion resistant package
- Compliant to RoHS directive 2002/95/EC

RoHS
 COMPLIANT

APPLICATIONS

- PDA/notebook/desktop/server applications
- High current POL converters
- Low profile, high current power supplies
- Battery powered devices
- DC/DC converters in distributed power systems
- DC/DC converter for Field Programmable Gate Array (FPGA)
- Harsh environments including moisture, chemicals and salt spray

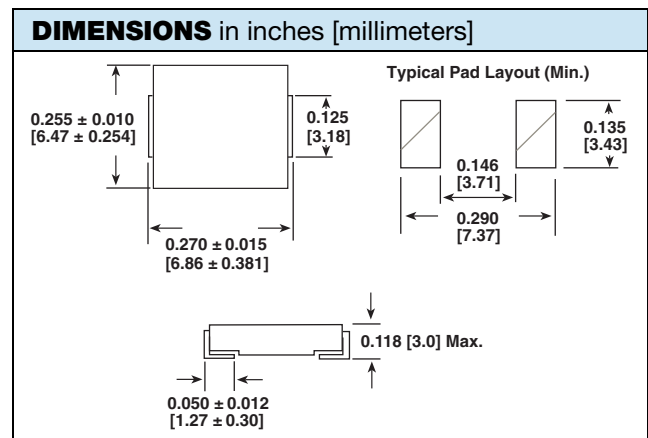



PERFORMANCE GRAPHS

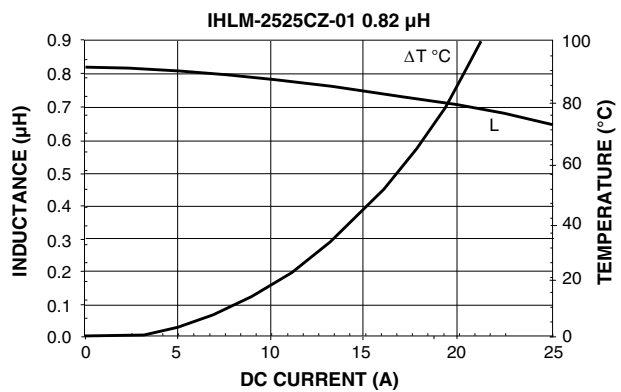
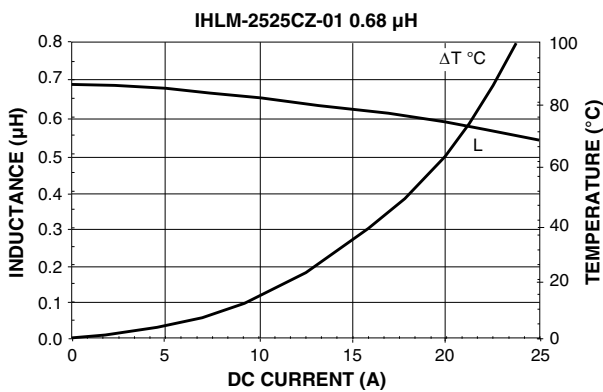
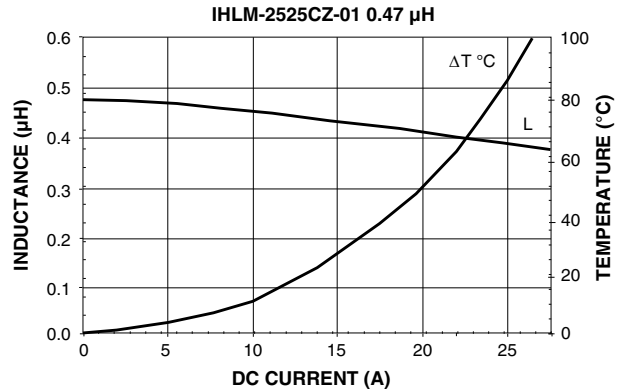
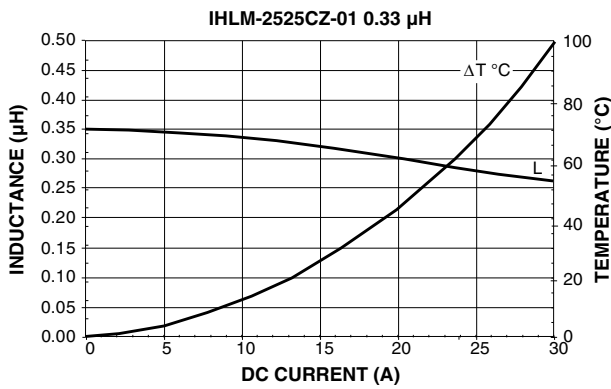
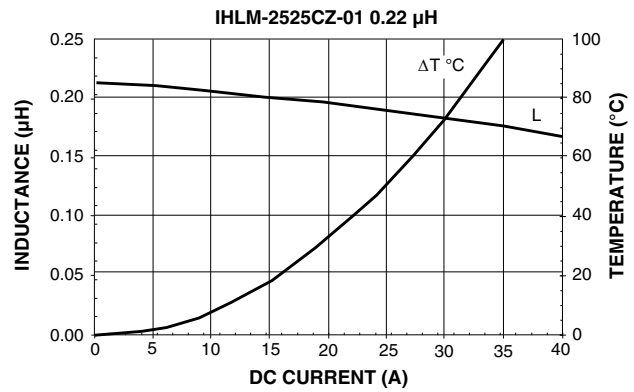
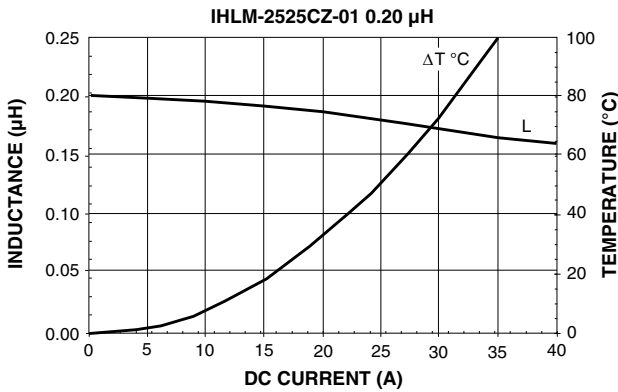
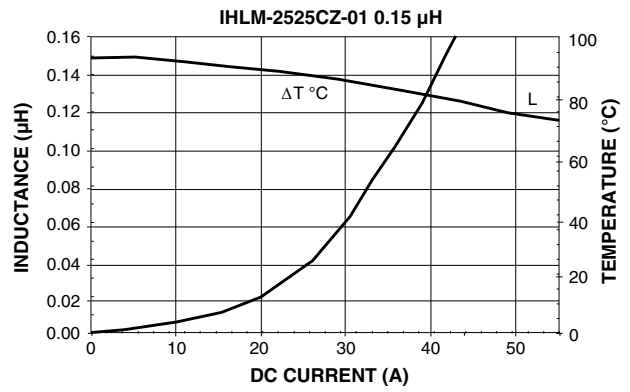
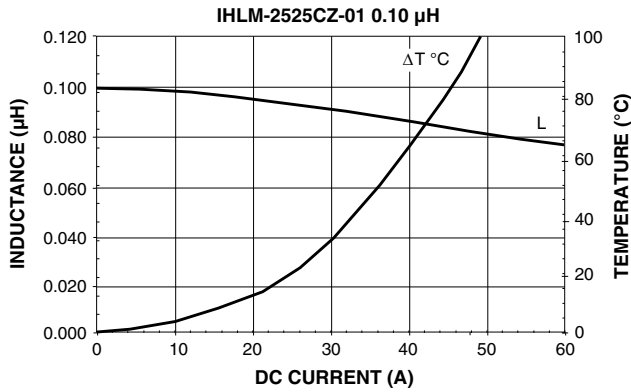



PERFORMANCE GRAPHS

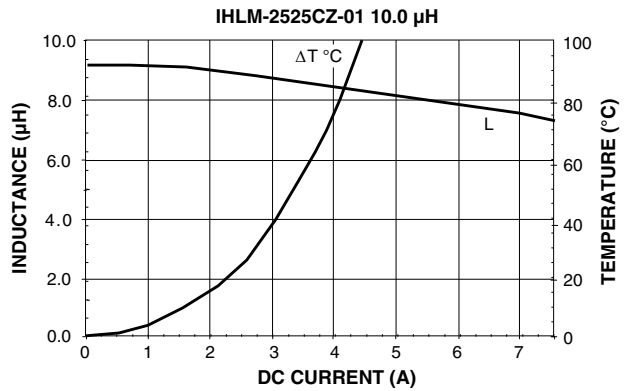
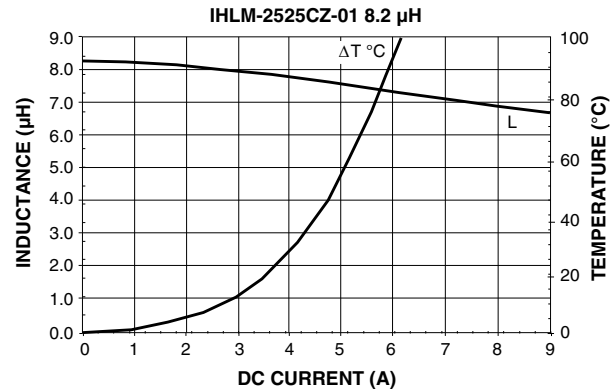
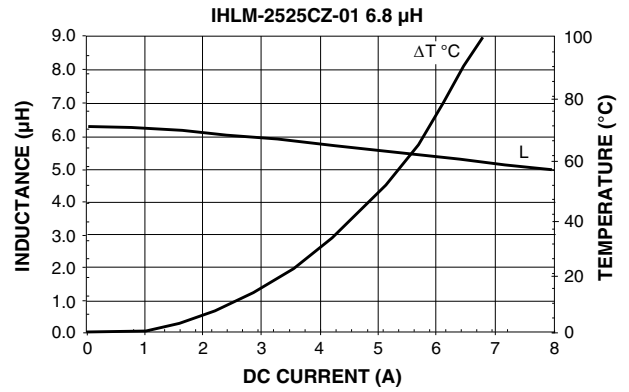
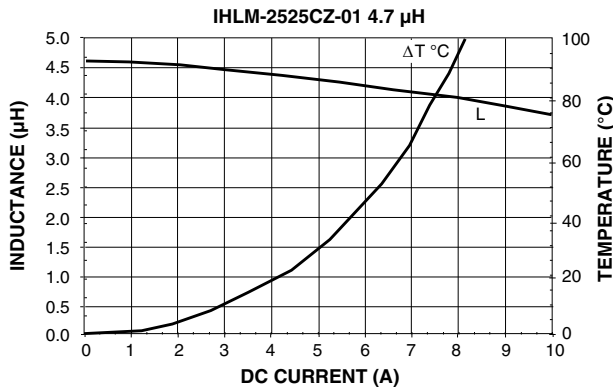
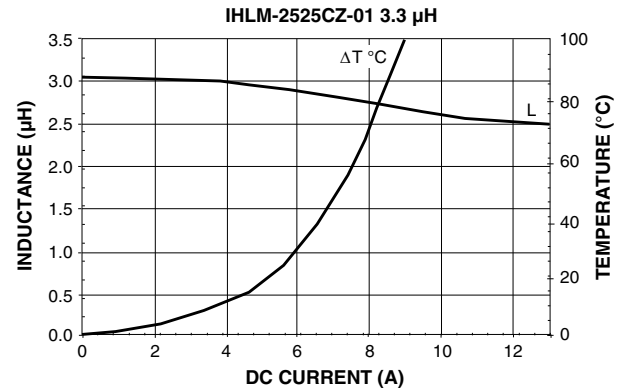
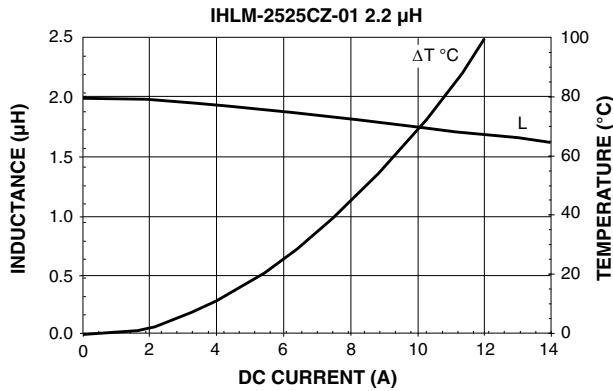
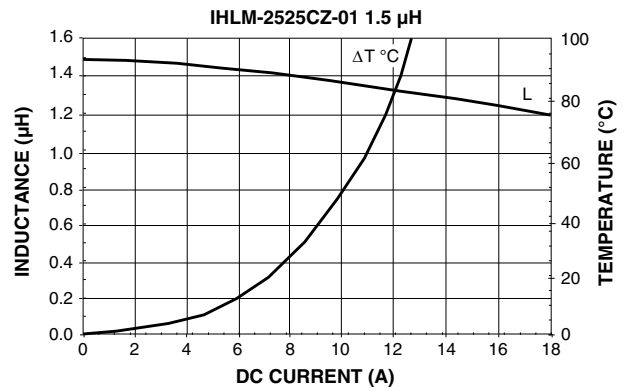
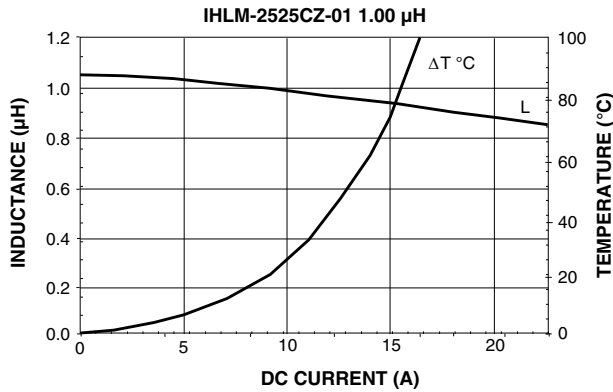

10 % DCR Tolerance, Low Profile, Power Inductors

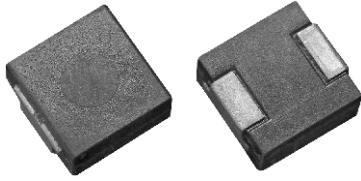

Manufactured under one or more of the following:
US Patents; 6,198,375/6,204,744/6,449,829/6,460,244.
 Several foreign patents, and other patents pending.

STANDARD ELECTRICAL SPECIFICATIONS			
L_0 INDUCTANCE $\pm 20\%$ AT 100 kHz, 0.25 V, 0 A (μH)	DCR $\pm 10\%$ AT 25 °C (m Ω)	HEAT RATING CURRENT DC TYP. (A) ⁽³⁾	SATURATION CURRENT DC TYP. (A) ⁽⁴⁾
0.10	1.37	32.5	60
0.20	2.34	24	41
0.33	3.20	20	30
0.47	3.86	17.5	26
0.68	5.20	15.5	25
0.82	7.41	13	24
1.0	8.44	11	22
1.5	14.50	9	18
2.2	17.73	8	14
3.3	28.21	6	13.5
4.7	37.11	5.5	10
8.2	61.47	4	7.5
10	97.71	3	7.0

Notes

- (1) All test data is referenced to 25 °C ambient
- (2) Operating temperature range - 55 °C to + 125 °C
- (3) DC current (A) that will cause an approximate ΔT of 40 °C
- (4) DC current (A) that will cause L_0 to drop approximately 20 %
- (5) The part temperature (ambient + temp. rise) should not exceed 125 °C under worst case operating conditions. Circuit design, component placement, PWB trace size and thickness, airflow and other cooling provisions all affect the part temperature. Part temperature should be verified in the end application.

FEATURES

- Lowest molded height (3.0 mm) in this package footprint
- Shielded construction
- Frequency range up to 5.0 MHz
- Lowest DCR/ μH , in this package size
- Handles high transient current spikes without saturation
- Ultra low buzz noise, due to composite construction
- Encapsulated body offers improved environmental protection and moisture resistance
- Higher dielectric withstanding voltage vs. IHLP
- Flame retardant encapsulant (UL 94 V-0)
- Corrosion resistant package
- Compliant to RoHS directive 2002/95/EC



APPLICATIONS

- Tolerance DCR for current sense applications
- Improved current balance in phased power supplies
- Improved thermal management
- PDA/notebook/desktop/server and battery powered devices
- High current, low profile POL converters
- DC/DC converters in distributed power systems
- DC/DC converter for Field Programmable Gate Array (FPGA)

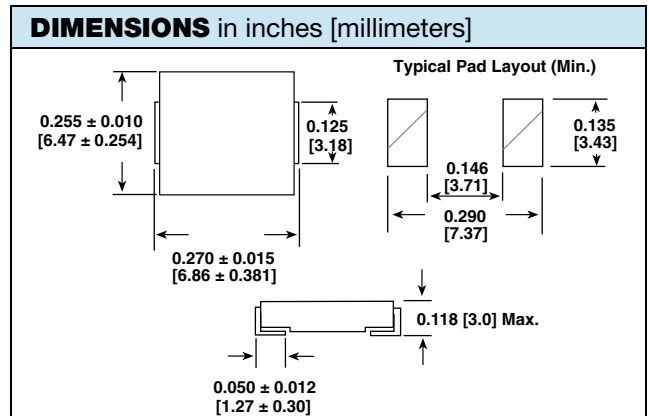

DESCRIPTION				
IHLM-2525CZ-06	1.0 μH	$\pm 20\%$	ER	e3
MODEL	INDUCTANCE VALUE	INDUCTANCE TOLERANCE	PACKAGE CODE	JEDEC LEAD (Pb)-FREE STANDARD

GLOBAL PART NUMBER																	
I	H	L	M	2	5	2	5	C	Z	E	R	1	R	0	M	0	6
PRODUCT FAMILY				SIZE					PACKAGE CODE		INDUCTANCE VALUE			TOL.	SERIES		



PERFORMANCE GRAPHS

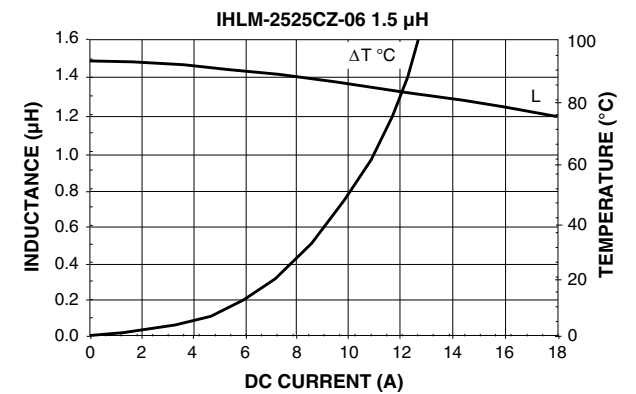
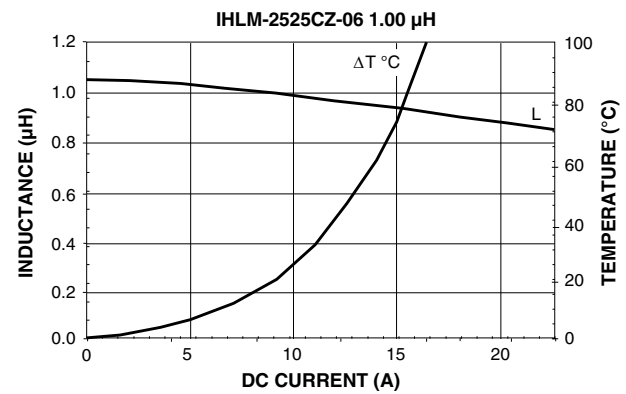
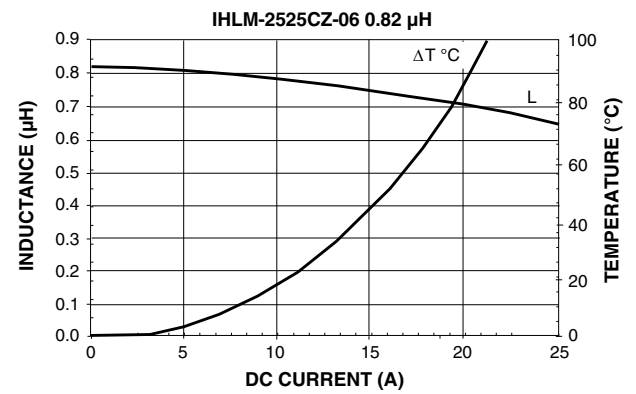
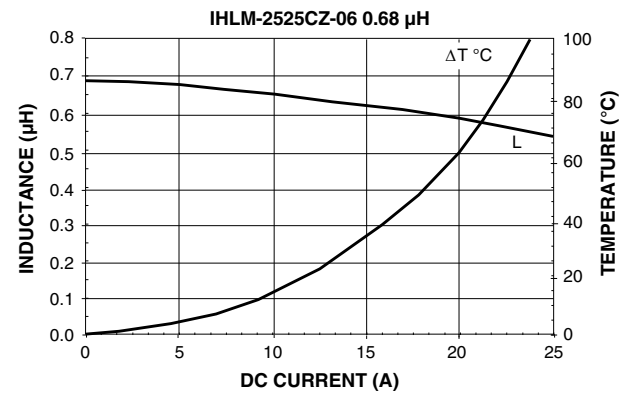
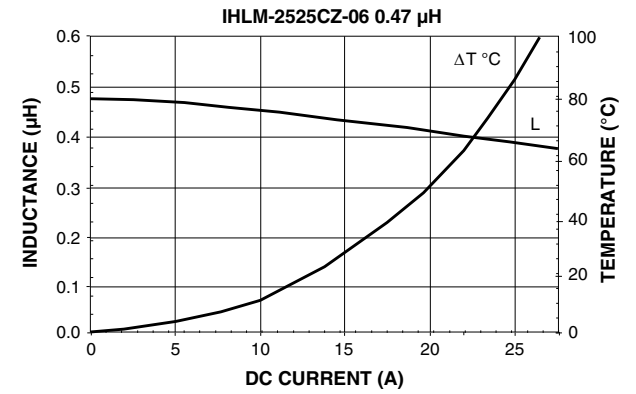
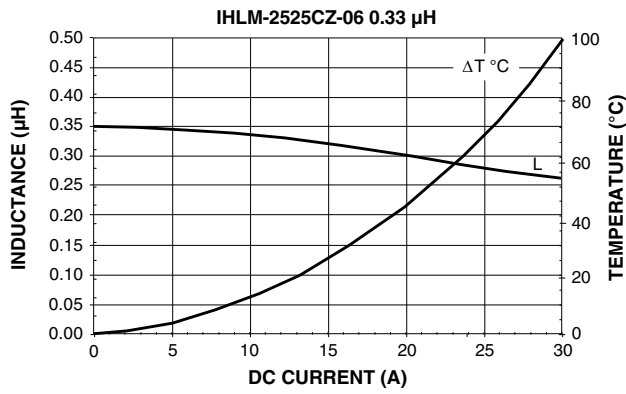
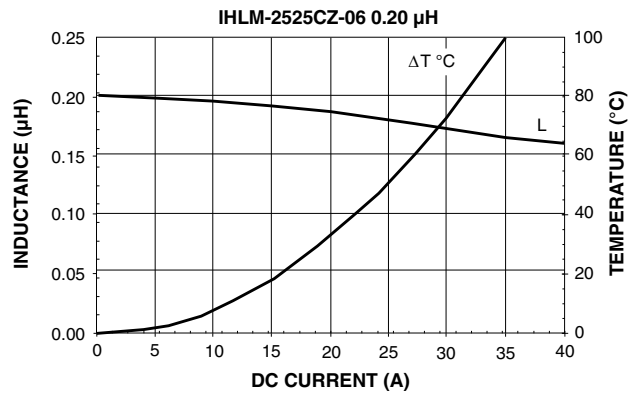
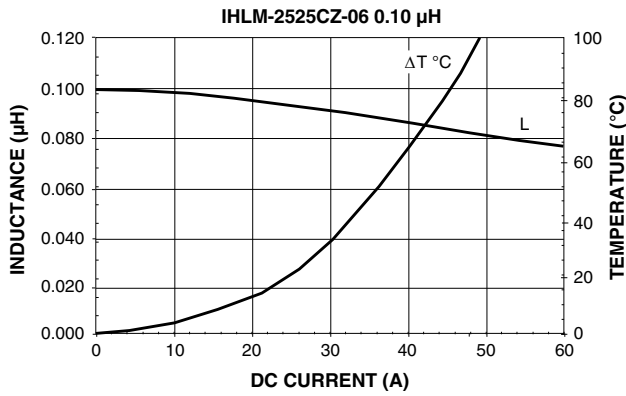

PERFORMANCE GRAPHS

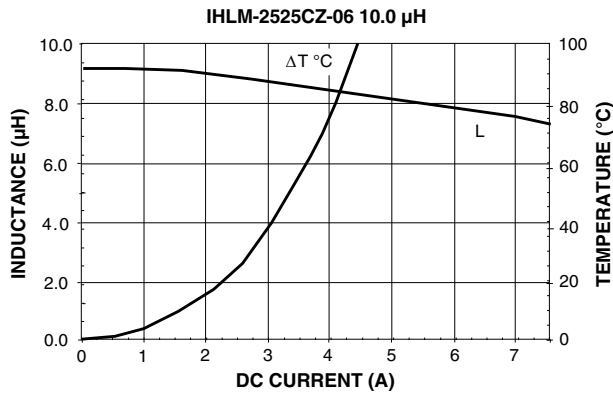
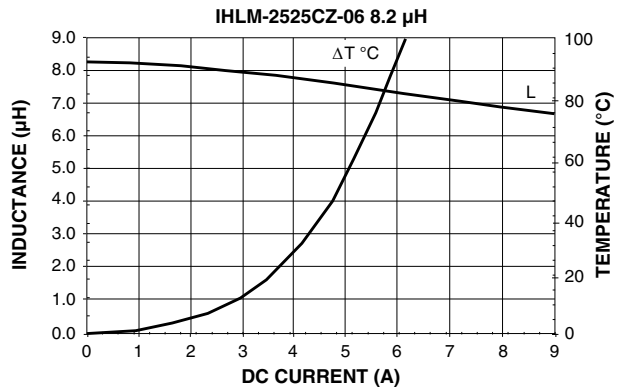
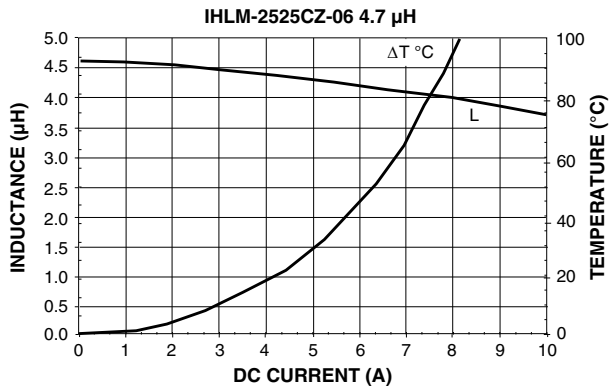
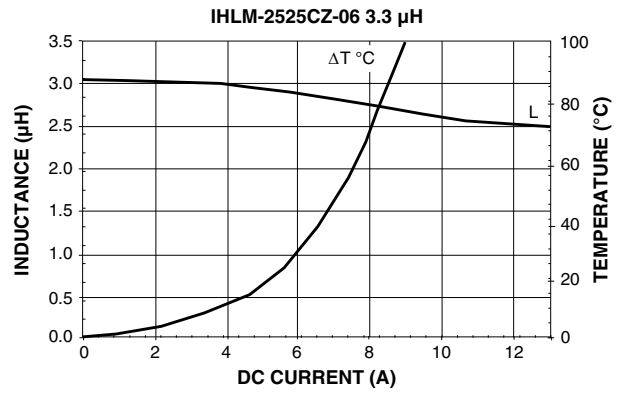
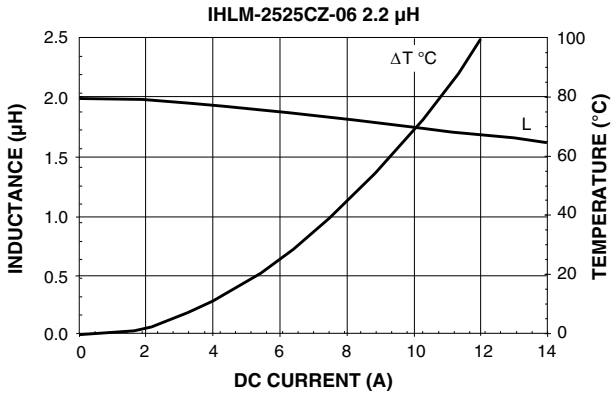

Low Profile, High Current IHLP® Inductors

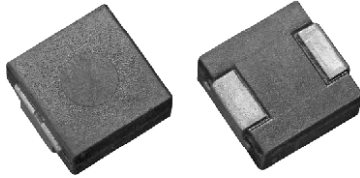

Manufactured under one or more of the following:
US Patents; 6,198,375/6,204,744/6,449,829/6,460,244.
 Several foreign patents, and other patents pending.

STANDARD ELECTRICAL SPECIFICATIONS			
L₀ INDUCTANCE ± 20 % AT 100 kHz, 0.25 V, 0 A (μH)	DCR ± 5 % AT 25 °C (mΩ)	HEAT RATING CURRENT DC TYP. (A) ⁽³⁾	SATURATION CURRENT DC TYP. (A) ⁽⁴⁾
0.10	1.37	32.5	60
0.15	1.85	26	52
0.20	2.34	24	41
0.33	3.20	20	30
0.47	3.86	17.5	26
0.68	5.20	15.5	25
0.82	7.41	13	24
1.0	8.44	11	22
1.5	14.50	9	18
2.2	17.73	8	14
3.3	28.21	6	13.5
4.7	37.11	5.5	10
8.2	61.47	4	7.5
10	97.71	3	7.0

Notes

- (1) All test data is referenced to 25 °C ambient
- (2) Operating temperature range - 55 °C to + 125 °C
- (3) DC current (A) that will cause an approximate ΔT of 40 °C
- (4) DC current (A) that will cause L₀ to drop approximately 20 %
- (5) The part temperature (ambient + temp. rise) should not exceed 125 °C under worst case operating conditions. Circuit design, component placement, PWB trace size and thickness, airflow and other cooling provisions all affect the part temperature. Part temperature should be verified in the end application.

DESCRIPTION				
IHLM-2525CZ-07	1.0 μH	± 20 %	ER	e3
MODEL	INDUCTANCE VALUE	INDUCTANCE TOLERANCE	PACKAGE CODE	JEDEC LEAD (Pb)-FREE STANDARD

GLOBAL PART NUMBER																	
I	H	L	M	2	5	2	5	C	Z	E	R	1	R	0	M	0	7
PRODUCT FAMILY				SIZE				PACKAGE CODE		INDUCTANCE VALUE			TOL.	SERIES			

FEATURES

- Lowest molded height (3.0 mm) in this package footprint
- Shielded construction
- Frequency range up to 5.0 MHz
- Lowest DCR/μH, in this package size
- Handles high transient current spikes without saturation
- Ultra low buzz noise, due to composite construction
- Encapsulated body offers improved environmental protection and moisture resistance
- Higher dielectric withstanding voltage vs. IHLP
- Flame retardant encapsulant (UL 94 V-0)
- Corrosion resistant package
- Compliant to RoHS directive 2002/95/EC



RoHS
COMPLIANT

APPLICATIONS

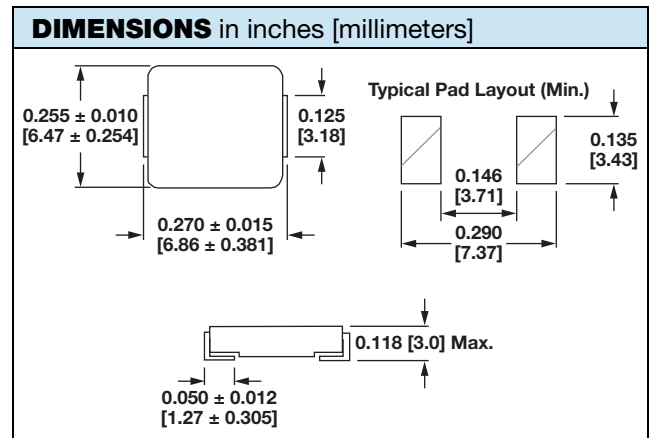
- Tolerance DCR for current sense applications
- Improved current balance in phased power supplies
- Improved thermal management
- PDA/notebook/desktop/server and battery powered devices
- High current, low profile POL converters
- DC/DC converters in distributed power systems
- DC/DC converter for Field Programmable Gate Array (FPGA)

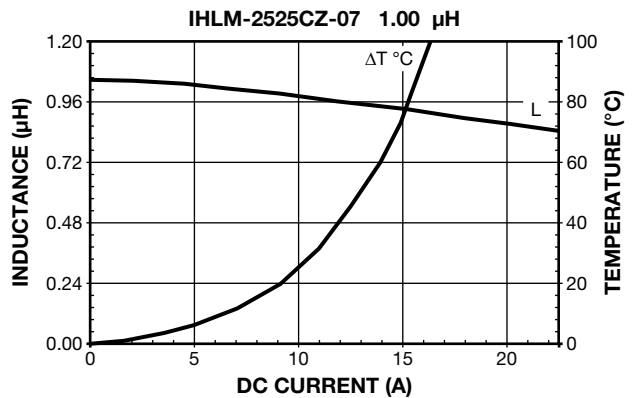
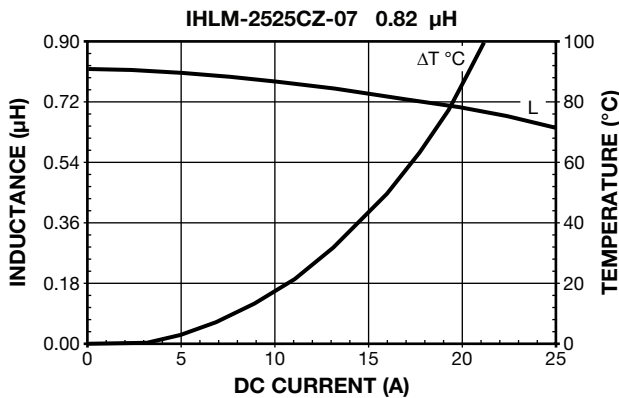
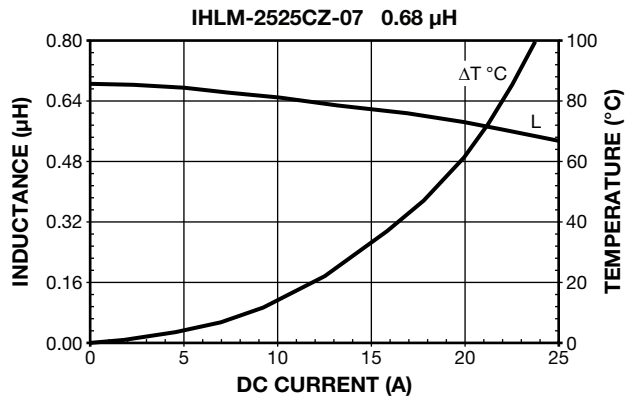
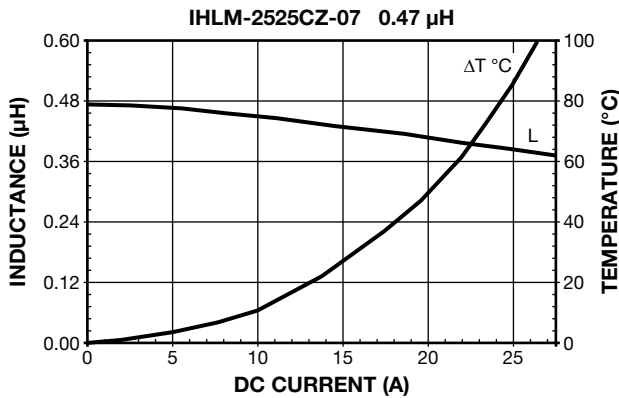
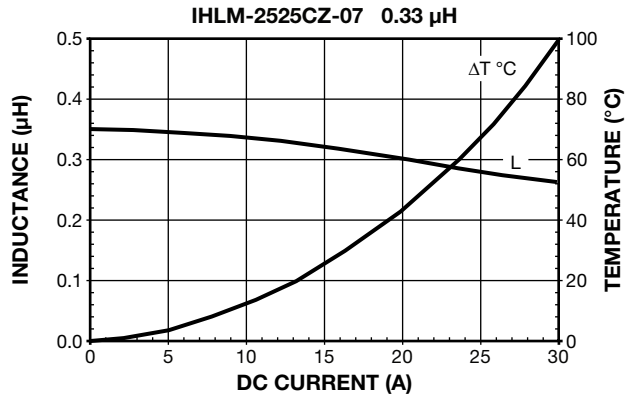
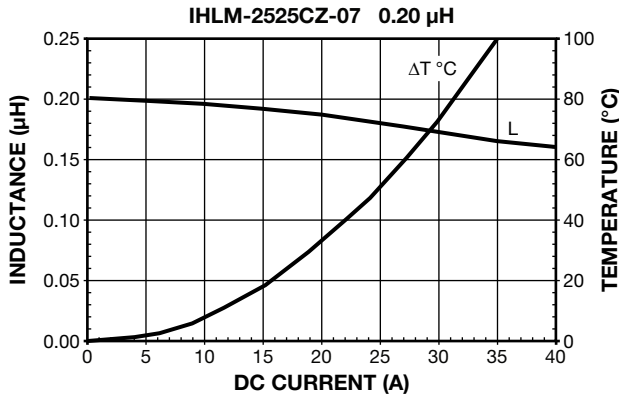
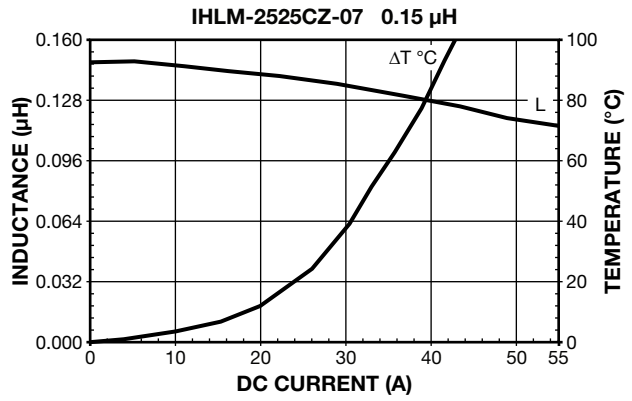
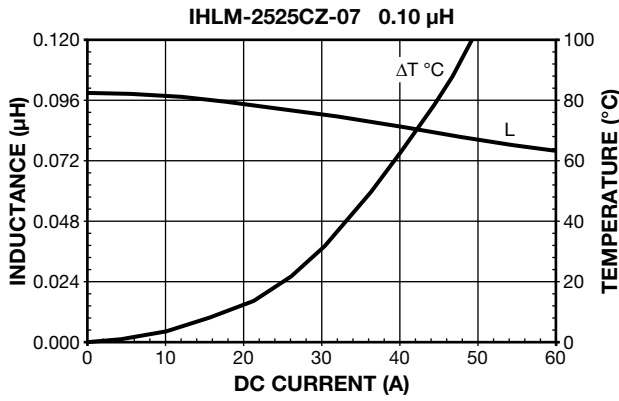

PERFORMANCE GRAPHS





PERFORMANCE GRAPHS

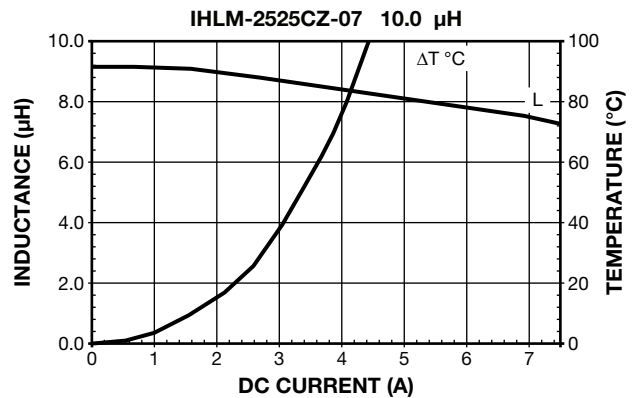
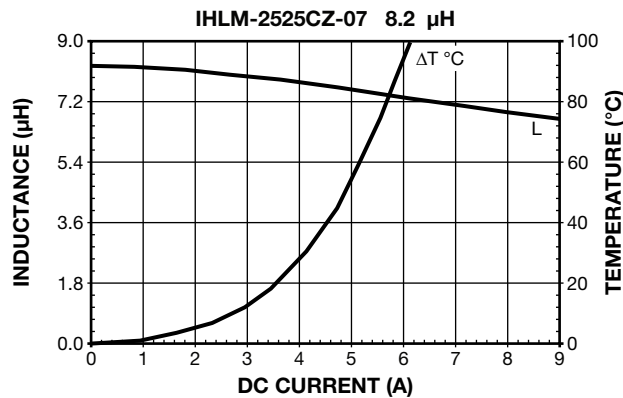
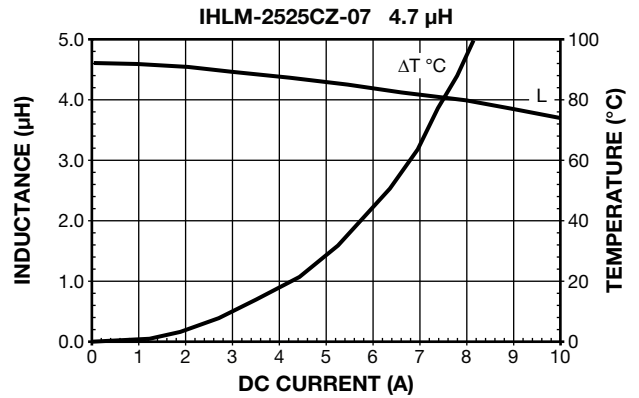
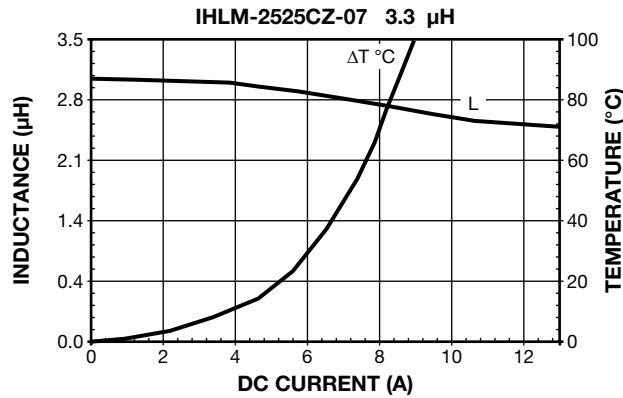
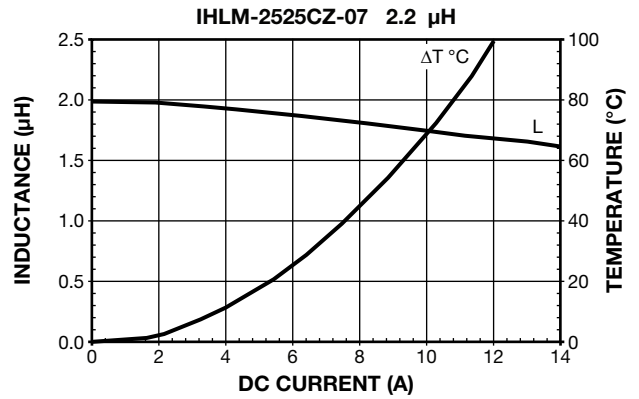
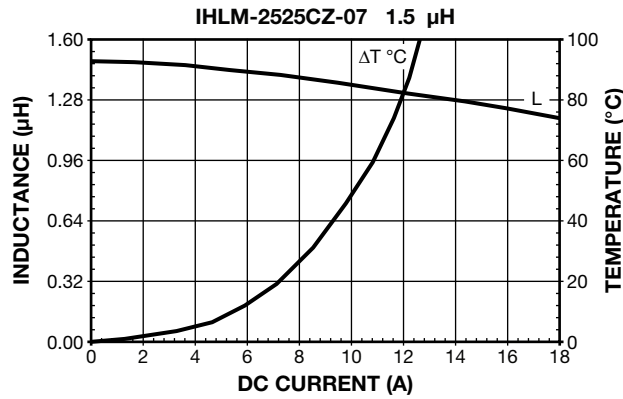

3 % DCR Tolerance, Low Profile, High Current Inductor



Patents Pending

STANDARD ELECTRICAL SPECIFICATIONS			
L₀ INDUCTANCE ± 20 % AT 100 kHz, 0.25 V, 0 A (μH)	DCR ± 3 % AT 25 °C (mΩ)	HEAT RATING CURRENT DC TYP. (A) ⁽³⁾	SATURATION CURRENT DC TYP. (A) ⁽⁴⁾
0.34	0.88	32	36
0.42			30
0.50			25
0.62			20

Notes

- (1) All test data is referenced to 25 °C ambient
- (2) Operating temperature range - 55 °C to + 125 °C
- (3) DC current (A) that will cause an approximate ΔT of 40 °C
- (4) DC current (A) that will cause L₀ to drop approximately 20 %
- (5) The part temperature (ambient + temp. rise) should not exceed 125 °C under worst case operating conditions. Circuit design, component placement, PWB trace size and thickness, airflow and other cooling provisions all affect the part temperature. Part temperature should be verified in the end application.

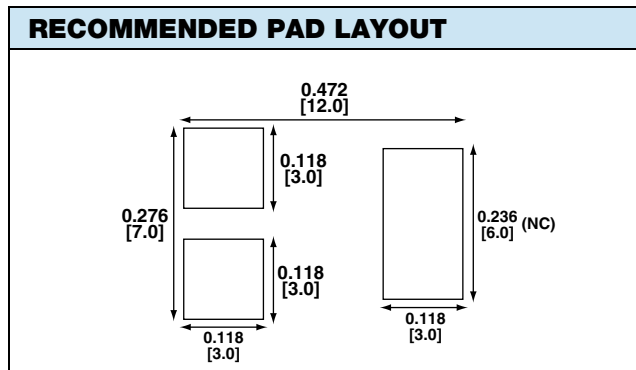

DESCRIPTION				
IFLP-4040DZ-01	0.42 μH	± 20 %	ER	e3
MODEL	INDUCTANCE VALUE	INDUCTANCE TOLERANCE	PACKAGE CODE	JEDEC LEAD (Pb)-FREE STANDARD

GLOBAL PART NUMBER

I	F	L	P	4	0	4	0	D	Z	E	R	R	4	2	M	0	1
PRODUCT FAMILY				SIZE					PACKAGE CODE		INDUCTANCE VALUE			TOL.	SERIES		

FEATURES

- Shielded construction
- Frequency range up to 5.0 MHz
- Lowest DCR/μH, in this package size
- Handles high transient current spikes without saturation
- Compliant to RoHS Directive 2002/95/EC



RoHS
COMPLIANT

APPLICATIONS

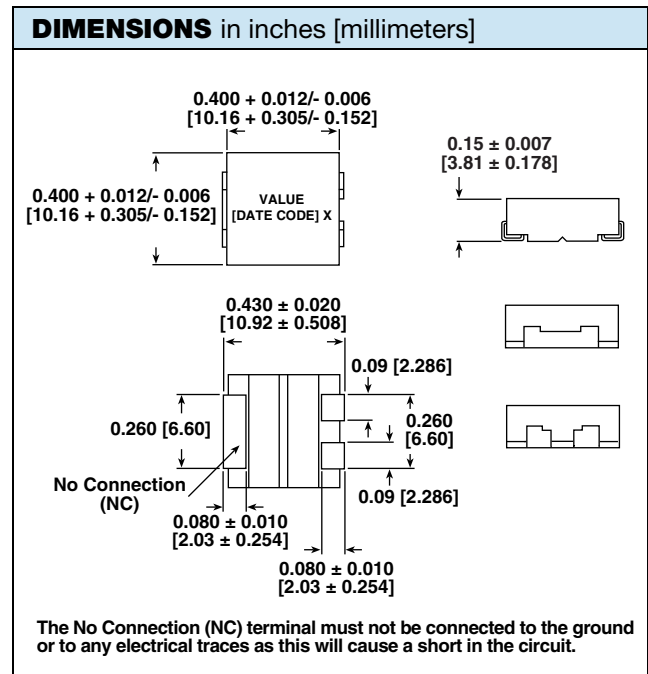
- Notebook/desktop/server applications
- High current POL converters
- Low profile, high current power supplies
- Battery powered devices
- DC/DC converters in distributed power systems

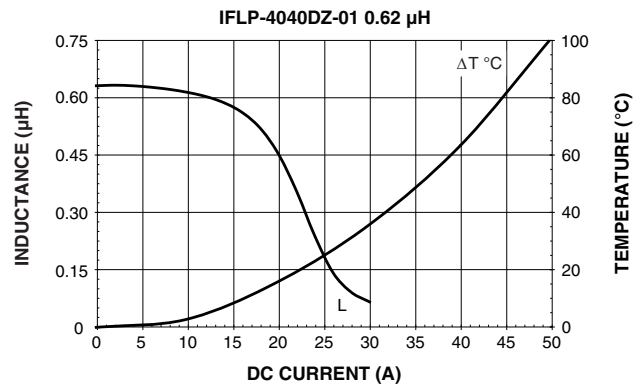
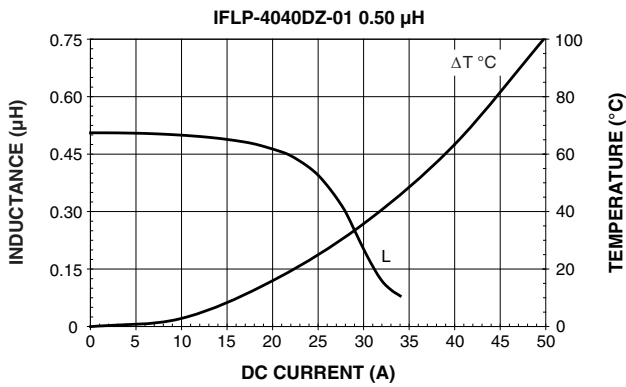
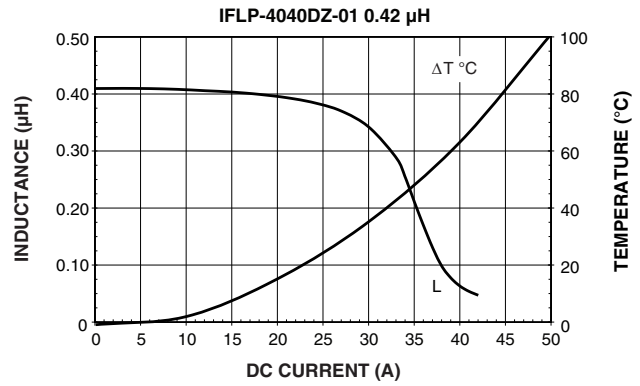
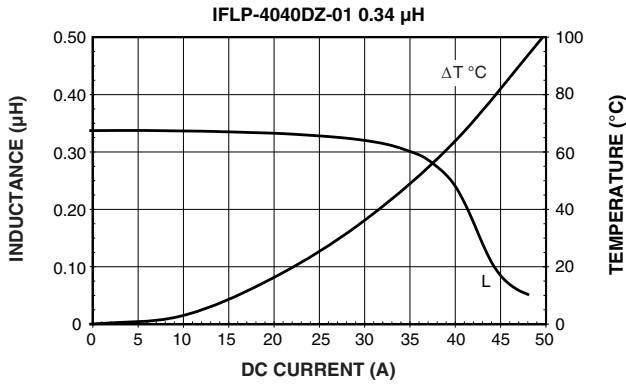

PERFORMANCE GRAPHS



Low Profile, High Current Inductors



FEATURES

- Shielded construction
- Frequency range up to 5.0 MHz
- Handles high transient current spikes without saturation
- Compliant to RoHS directive 2002/95/EC

RoHS
COMPLIANT

APPLICATIONS

- PDA/notebook/desktop/server applications
- High current POL converters
- Low profile, high current power supplies
- DC/DC converters in distributed power systems
- DC/DC converter for field programmable gate array (FPGA)

STANDARD ELECTRICAL SPECIFICATIONS				
L_0 INDUCTANCE $\pm 20\%$ AT 100 kHz, 0.25 V, 0 A (μH)	DCR TYP. 25 °C (m Ω)	DCR MAX. 25 °C (m Ω)	HEAT RATING CURRENT DC TYP. (A) ⁽³⁾	SATURATION CURRENT DC TYP. (A) ⁽⁴⁾
1.0	96	115	1.60	1.88
1.5	143	172	1.40	1.63
2.2	196	236	1.30	1.40
3.3	247	297	1.05	1.00
4.7	331	398	0.90	0.85
6.8	623	748	0.60	0.80
10.0	1108	1330	0.45	0.62
22.0	2367	2840	0.30	0.43

Notes

- (1) All test data is referenced to 25 °C ambient
- (2) Operating temperature range - 55 °C to + 125 °C
- (3) DC current (A) that will cause an approximate ΔT of 40 °C
- (4) DC current (A) that will cause L_0 to drop approximately 30 %
- (5) The part temperature (ambient + temp. rise) should not exceed 125 °C under worst case operating conditions. Circuit design, component placement, PWB trace size and thickness, airflow and other cooling provisions all affect the part temperature. Part temperature should be verified in the end application.

DIMENSIONS in inches [millimeters]

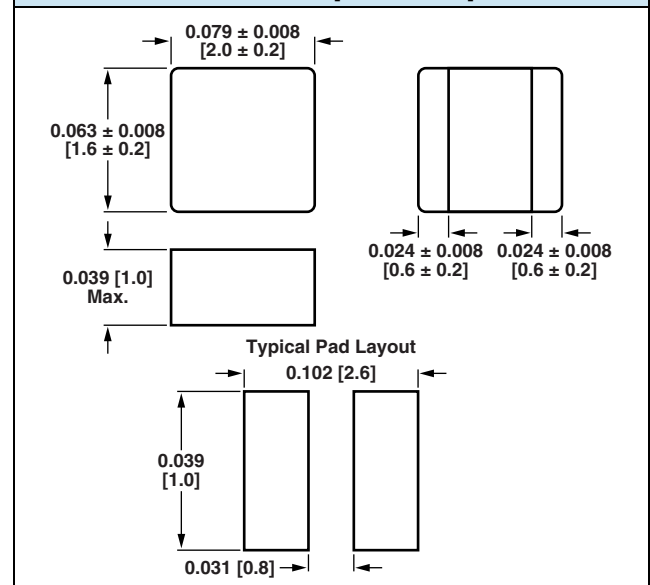

DESCRIPTION

IFSC-0806AZ-01	4.7 μH	$\pm 20\%$	ER	e3
MODEL	INDUCTANCE VALUE	INDUCTANCE TOLERANCE	PACKAGE CODE	JEDEC LEAD (Pb)-FREE STANDARD

GLOBAL PART NUMBER

I	F	S	C	0	8	0	6	A	Z	E	R	4	R	7	M	0	1
PRODUCT FAMILY				SIZE						PACKAGE CODE		INDUCTANCE VALUE		TOL.	SERIES		

Low Profile, High Current Inductors

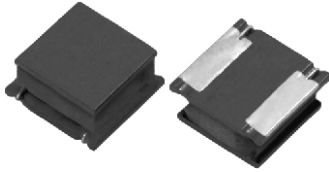

FEATURES

- Shielded construction
- Frequency range up to 5.0 MHz
- Handles high transient current spikes without saturation
- Compliant to RoHS directive 2002/95/EC

RoHS
COMPLIANT

STANDARD ELECTRICAL SPECIFICATIONS

L_0 INDUCTANCE $\pm 20\%$ AT 100 kHz, 0.25 V, 0 A (μH)	DCR TYP. 25 °C (m Ω)	DCR MAX. 25 °C (m Ω)	HEAT RATING CURRENT DC TYP. (A) ⁽³⁾	SATURATION CURRENT DC TYP. (A) ⁽⁴⁾
0.47	25	29	3.70	3.90
1.0	37	43	2.60	2.70
1.5	63	72	2.20	2.30
2.2	80	90	1.85	2.15
3.3	140	155	1.45	1.70
4.7	190	212	1.20	1.50
6.0	260	288	1.10	1.35
6.8	325	370	1.00	1.15
10.0	360	410	0.75	0.85
22.0	910	1050	0.50	0.56

Notes

- (1) All test data is referenced to 25 °C ambient
- (2) Operating temperature range - 55 °C to + 125 °C
- (3) DC current (A) that will cause an approximate ΔT of 40 °C
- (4) DC current (A) that will cause L_0 to drop approximately 30 %
- (5) The part temperature (ambient + temp. rise) should not exceed 125 °C under worst case operating conditions. Circuit design, component placement, PWB trace size and thickness, airflow and other cooling provisions all affect the part temperature. Part temperature should be verified in the end application.

APPLICATIONS

- PDA/notebook/desktop/server applications
- High current POL converters
- Low profile, high current power supplies
- Battery powered devices
- DC/DC converters in distributed power systems
- DC/DC converter for field programmable gate array (FPGA)

DIMENSIONS in inches [millimeters]

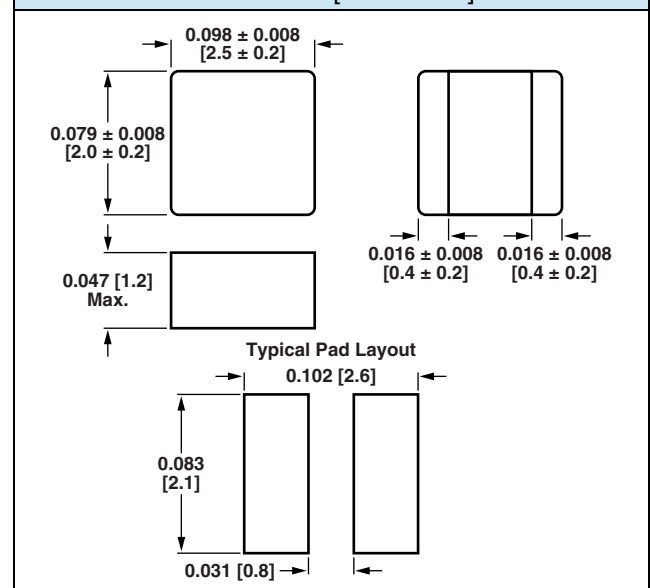

DESCRIPTION

IFSC-1008AB-01	4.7 μH	$\pm 20\%$	ER	e3
MODEL	INDUCTANCE VALUE	INDUCTANCE TOLERANCE	PACKAGE CODE	JEDEC LEAD (Pb)-FREE STANDARD

GLOBAL PART NUMBER

I	F	S	C	1	0	0	8	A	B	E	R	4	R	7	M	0	1
PRODUCT FAMILY				SIZE						PACKAGE CODE		INDUCTANCE VALUE		TOL.	SERIES		

Low Profile, High Current Inductors

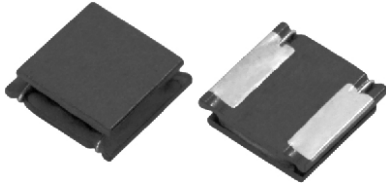

FEATURES

- Shielded construction
- Frequency range up to 5.0 MHz
- Handles high transient current spikes without saturation
- Compliant to RoHS directive 2002/95/EC

RoHS
COMPLIANT

APPLICATIONS

- PDA/notebook/desktop/server applications
- High current POL converters
- Low profile, high current power supplies
- Battery powered devices
- DC/DC converters in distributed power systems
- DC/DC converter for field programmable gate array (FPGA)

STANDARD ELECTRICAL SPECIFICATIONS				
L_0 INDUCTANCE $\pm 20\%$ AT 100 kHz, 0.25 V, 0 A (μH)	DCR TYP. 25 °C (m Ω)	DCR MAX. 25 °C (m Ω)	HEAT RATING CURRENT DC TYP. (A) ⁽³⁾	SATURATION CURRENT DC TYP. (A) ⁽⁴⁾
1.0	55	68	2.00	1.50
1.5	65	75	1.45	1.35
2.2	90	105	1.30	1.10
3.3	130	150	1.20	0.90
4.7	170	200	1.00	0.75
6.8	200	230	0.90	0.65
10.0	300	340	0.80	0.52
15.0	500	570	0.65	0.40
22.0	650	750	0.50	0.35
33.0	1000	1250	0.40	0.30
47.0	1800	2050	0.35	0.235

Notes

- (1) All test data is referenced to 25 °C ambient
- (2) Operating temperature range - 55 °C to + 125 °C
- (3) DC current (A) that will cause an approximate ΔT of 40 °C
- (4) DC current (A) that will cause L_0 to drop approximately 30 %
- (5) The part temperature (ambient + temp. rise) should not exceed 125 °C under worst case operating conditions. Circuit design, component placement, PWB trace size and thickness, airflow and other cooling provisions all affect the part temperature. Part temperature should be verified in the end application.

DIMENSIONS in inches [millimeters]

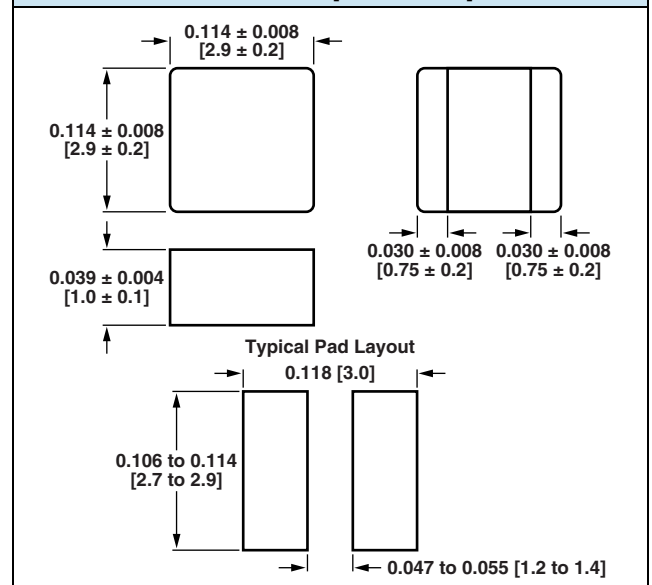

DESCRIPTION

IFSC-1111AZ-01	4.7 μH	$\pm 20\%$	ER	e3
MODEL	INDUCTANCE VALUE	INDUCTANCE TOLERANCE	PACKAGE CODE	JEDEC LEAD (Pb)-FREE STANDARD

GLOBAL PART NUMBER

I	F	S	C	1	1	1	1	A	Z	E	R	4	R	7	M	0	1
PRODUCT FAMILY				SIZE						PACKAGE CODE		INDUCTANCE VALUE			TOL.	SERIES	

Low Profile, High Current Inductors

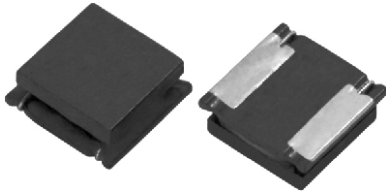

FEATURES

- Shielded construction
- Frequency range up to 5.0 MHz
- Handles high transient current spikes without saturation
- Compliant to RoHS directive 2002/95/EC

RoHS
COMPLIANT

APPLICATIONS

- PDA/notebook/desktop/server applications
- High current POL converters
- Low profile, high current power supplies
- Battery powered devices
- DC/DC converters in distributed power systems
- DC/DC converter for field programmable gate array (FPGA)

STANDARD ELECTRICAL SPECIFICATIONS				
L_0 INDUCTANCE $\pm 20\%$ AT 100 kHz, 0.25 V, 0 A (μH)	DCR TYP. 25 °C (m Ω)	DCR MAX. 25 °C (m Ω)	HEAT RATING CURRENT DC TYP. (A) ⁽³⁾	SATURATION CURRENT DC TYP. (A) ⁽⁴⁾
2.2	82	98	1.9	1.7
3.3	100	120	1.7	1.5
4.7	130	156	1.4	1.2
6.8	190	228	1.2	1.0
10.0	280	336	1.0	0.8
22.0	630	756	0.67	0.55

Notes

- (1) All test data is referenced to 25 °C ambient
- (2) Operating temperature range - 55 °C to + 125 °C
- (3) DC current (A) that will cause an approximate ΔT of 40 °C
- (4) DC current (A) that will cause L_0 to drop approximately 30 %
- (5) The part temperature (ambient + temp. rise) should not exceed 125 °C under worst case operating conditions. Circuit design, component placement, PWB trace size and thickness, airflow and other cooling provisions all affect the part temperature. Part temperature should be verified in the end application.

DIMENSIONS in inches [millimeters]

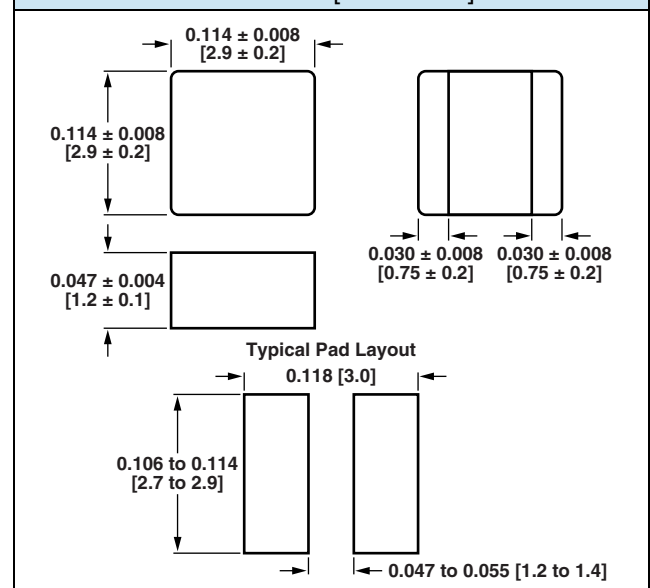

DESCRIPTION

IFSC-1111AB-01	4.7 μH	$\pm 20\%$	ER	e3
MODEL	INDUCTANCE VALUE	INDUCTANCE TOLERANCE	PACKAGE CODE	JEDEC LEAD (Pb)-FREE STANDARD

GLOBAL PART NUMBER

I	F	S	C	1	1	1	1	A	B	E	R	4	R	7	M	0	1
PRODUCT FAMILY				SIZE					PACKAGE CODE		INDUCTANCE VALUE			TOL.	SERIES		

Low Profile, High Current Inductors

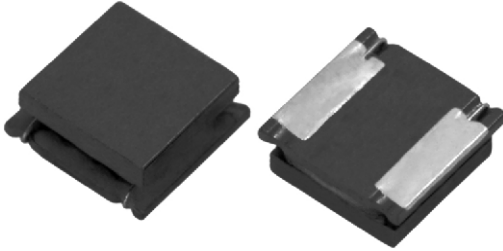

FEATURES

- Shielded construction
- Frequency range up to 5.0 MHz
- Handles high transient current spikes without saturation
- Compliant to RoHS Directive 2002/95/EC

RoHS
COMPLIANT

APPLICATIONS

- PDA/notebook/desktop/server applications
- High current POL converters
- Low profile, high current power supplies
- Battery powered devices
- DC/DC converters in distributed power systems
- DC/DC converter for field programmable gate array (FPGA)

STANDARD ELECTRICAL SPECIFICATIONS				
L_0 INDUCTANCE $\pm 20\%$ AT 100 kHz, 0.25 V, 0 A (μH)	DCR TYP. 25 °C (m Ω)	DCR MAX. 25 °C (m Ω)	HEAT RATING CURRENT DC TYP. (A) ⁽³⁾	SATURATION CURRENT DC TYP. (A) ⁽⁴⁾
0.56	17	22	5.40	5.50
1.0	20	25	3.80	3.80
1.2	25	30	3.60	3.60
2.2	35	45	3.00	3.00
3.3	45	56	2.70	2.40
4.7	70	90	2.20	2.00
6.8	90	115	1.90	1.50
8.2	105	132	1.40	1.40
10.0	135	170	1.30	1.30
15.0	185	222	1.25	1.00
22.0	250	315	1.20	0.83
33.0	405	486	0.90	0.68
47.0	495	594	0.80	0.56

Notes

- (1) All test data is referenced to 25 °C ambient
- (2) Operating temperature range - 55 °C to + 125 °C
- (3) DC current (A) that will cause an approximate ΔT of 40 °C
- (4) DC current (A) that will cause L_0 to drop approximately 30 %
- (5) The part temperature (ambient + temp. rise) should not exceed 125 °C under worst case operating conditions. Circuit design, component placement, PWB trace size and thickness, airflow and other cooling provisions all affect the part temperature. Part temperature should be verified in the end application.

DIMENSIONS in inches [millimeters]

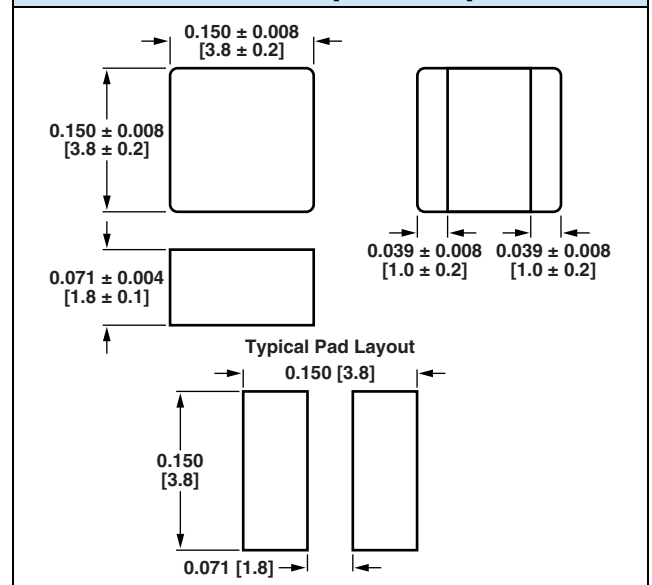

DESCRIPTION

IFSC-1515AH-01	3.3 μH	$\pm 20\%$	ER	e3
MODEL	INDUCTANCE VALUE	INDUCTANCE TOLERANCE	PACKAGE CODE	JEDEC LEAD (Pb)-FREE STANDARD

GLOBAL PART NUMBER

I	F	S	C	1	5	1	5	A	H	E	R	3	R	3	M	0	1
PRODUCT FAMILY				SIZE				PACKAGE CODE		INDUCTANCE VALUE		TOL.	SERIES				

High Current, Surface Mount Inductors



STANDARD ELECTRICAL SPECIFICATIONS			
IND. AT 1 kHz (μH)	DCR MAX. (Ω)	RATED CURRENT MAX. (A)	INCREMENTAL CURRENT APPROX. (A)
1.0	0.015	5.11	4.41
1.2	0.016	4.93	4.11
1.5	0.017	4.63	3.66
1.8	0.022	4.27	3.22
2.2	0.031	3.61	2.62
2.7	0.038	3.18	2.40
3.3	0.045	2.94	2.13
3.9	0.062	2.57	2.05
4.7	0.083	2.17	1.93
5.6	0.091	2.08	1.79
6.8	0.101	1.94	1.62
8.2	0.118	1.83	1.50
10.0	0.126	1.74	1.36
12.0	0.170	1.50	1.26
15.0	0.228	1.29	1.11
18.0	0.306	1.13	1.05
22.0	0.336	1.05	0.96
27.0	0.389	0.98	0.86
33.0	0.440	0.92	0.75
39.0	0.490	0.86	0.72
47.0	0.646	0.74	0.68
56.0	0.845	0.65	0.64
68.0	1.040	0.61	0.58
82.0	1.240	0.56	0.51
100.0	1.440	0.48	0.42
120.0	2.180	0.45	0.40
150.0	2.900	0.38	0.37
180.0	3.280	0.36	0.33
220.0	3.650	0.34	0.28
270.0	4.400	0.29	0.26
330.0	5.070	0.27	0.23
390.0	5.900	0.23	0.20
470.0	7.670	0.22	0.19
560.0	8.850	0.21	0.17
680.0	10.20	0.18	0.15
820.0	11.58	0.17	0.14
1000.0	12.97	0.16	0.13

FEATURES

- Flame retardant encapsulant (UL 94 V-0)
- Completely encapsulated winding provides superior environmental protection and moisture resistance
- High current unit in surface mount package printed with model, inductance value and date code
- Compatible with infrared or conventional reflow soldering methods
- Pick and place compatible
- Compliant to RoHS Directive 2002/95/EC



APPLICATIONS

Excellent power line noise filters, filters for switching regulated power supplies, DC/DC converters, SCR and triac controls and RFI suppression.

ELECTRICAL SPECIFICATIONS

Inductance: Measured at 1 V with no DC current

Inductance Tolerance: ± 15 %

Incremental Current: The typical current at which the inductance will be decreased by 5 % from its initial zero DC value

Operating Temperature: - 55 °C to + 125 °C (no load);
- 55 °C to + 85 °C (at full rated current)

MECHANICAL SPECIFICATIONS

Core: High resistivity ferrite core

Encapsulant: Epoxy

Terminals: 100 % Sn over Ni

DIMENSIONS in inches [millimeters]

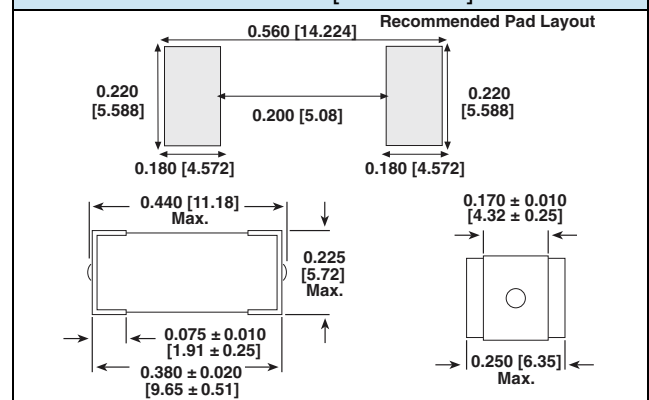

PART MARKING

- Model
- Inductance value
- Date code

DESCRIPTION

IHSM-3825	3.9 μH	± 15 %	ER	e3
MODEL	INDUCTANCE VALUE	INDUCTANCE TOLERANCE	PACKAGE CODE	JEDEC LEAD (Pb)-FREE STANDARD

GLOBAL PART NUMBER

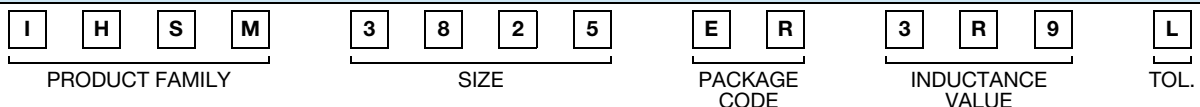

High Current, Surface Mount Inductors



STANDARD ELECTRICAL SPECIFICATIONS			
IND. AT 1 kHz (μH)	DCR MAX. (Ω)	RATED CURRENT MAX. (A)	INCREMENTAL CURRENT APPROX. (A)
1.0	0.013	8.6	4.1
1.2	0.018	7.6	3.8
1.5	0.02	6.9	3.5
1.8	0.021	6.5	3.2
2.2	0.029	5.7	2.9
2.7	0.034	5.1	2.6
3.3	0.038	4.6	2.4
3.9	0.042	4.3	2.2
4.7	0.047	4.0	2.0
5.6	0.051	3.8	1.9
6.8	0.058	3.5	1.7
8.2	0.063	3.3	1.5
10.0	0.071	3.1	1.4
12.0	0.079	2.7	1.3
15.0	0.089	2.3	1.2
18.0	0.119	1.9	1.1
22.0	0.152	1.7	1.02
27.0	0.179	1.6	0.95
33.0	0.222	1.3	0.88
39.0	0.315	1.19	0.8
47.0	0.362	1.07	0.74
56.0	0.397	0.95	0.68
68.0	0.446	0.87	0.62
82.0	0.604	0.8	0.56
100.0	0.672	0.73	0.5
120.0	0.735	0.66	0.45
150.0	0.998	0.58	0.4
180.0	1.37	0.5	0.35
220.0	1.58	0.46	0.32
270.0	1.77	0.41	0.3
330.0	2.51	0.37	0.28
390.0	2.73	0.34	0.26
470.0	3.36	0.32	0.24
560.0	3.75	0.3	0.23
680.0	4.31	0.28	0.2
820.0	6.04	0.26	0.17
1000.0	6.9	0.24	0.15

FEATURES

- Flame retardant encapsulant (UL 94 V-0)
- Completely encapsulated winding provides superior environmental protection and moisture resistance
- High current unit in surface mount package printed with model, inductance value and date code
- Compatible with infrared or conventional reflow soldering methods
- Pick and place compatible
- Tape and reel packaging for automatic handling
- Compliant to RoHS Directive 2002/95/EC

RoHS
COMPLIANT

APPLICATIONS

Excellent power line noise filters, filters for switching regulated power supplies, DC/DC converters, SCR and triac controls and RFI suppression.

ELECTRICAL SPECIFICATIONS

Inductance: Measured at 1 V with no DC current

Inductance Tolerance: ± 15 %

Incremental Current: The typical current at which the inductance will be decreased by 5 % from its initial zero DC value

Operating Temperature: - 55 °C to + 125 °C (no load);
- 55 °C to + 85 °C (at full rated current)

MECHANICAL SPECIFICATIONS

Core: High resistivity ferrite core

Encapsulant: Epoxy

Terminals: 100 % Sn over Ni

DIMENSIONS in inches [millimeters]

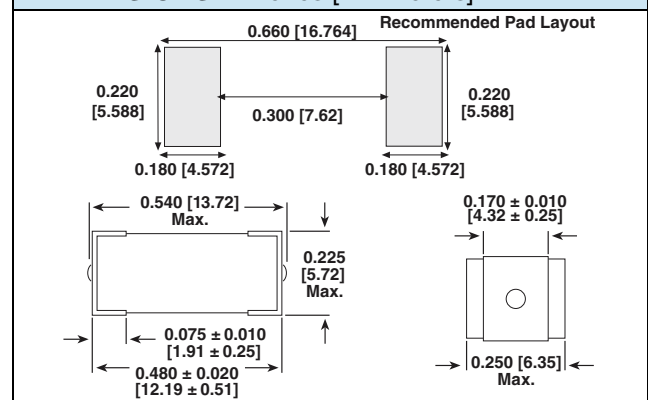

PART MARKING

- Model
- Inductance value
- Date code

DESCRIPTION

IHSM-4825	3.9 μH	± 15 %	ER	e3
MODEL	INDUCTANCE VALUE	INDUCTANCE TOLERANCE	PACKAGE CODE	JEDEC LEAD (Pb)-FREE STANDARD

GLOBAL PART NUMBER

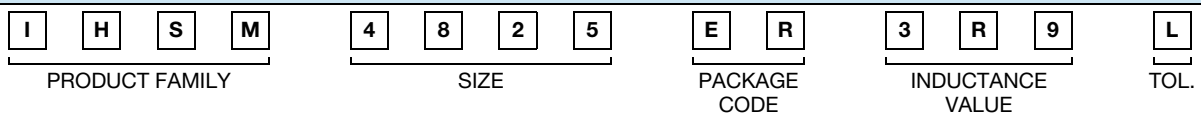

High Current, Surface Mount Inductors



STANDARD ELECTRICAL SPECIFICATIONS			
IND. AT 1 kHz (μH)	DCR MAX. (Ω)	RATED CURRENT MAX. (A)	INCREMENTAL CURRENT APPROX. (A)
1.0	0.010	9.0	6.2
1.2	0.011	8.8	5.6
1.5	0.012	8.7	5.0
1.8	0.013	8.6	4.4
2.2	0.015	8.5	4.0
2.7	0.017	8.4	3.7
3.3	0.020	8.3	3.4
3.9	0.021	7.9	3.1
4.7	0.023	7.4	2.8
5.6	0.024	7.0	2.6
6.8	0.038	6.1	2.3
8.2	0.047	5.1	2.0
10.0	0.053	4.3	1.8
12.0	0.068	3.9	1.7
15.0	0.078	3.5	1.6
18.0	0.083	3.2	1.5
22.0	0.12	2.8	1.3
27.0	0.14	2.3	1.2
33.0	0.17	1.9	1.1
39.0	0.19	1.8	1.03
47.0	0.215	1.77	0.93
56.0	0.236	1.71	0.90
68.0	0.305	1.43	0.82
82.0	0.357	1.14	0.75
100.0	0.452	0.95	0.68
120.0	0.530	0.88	0.63
150.0	0.609	0.82	0.58
180.0	0.809	0.75	0.54
220.0	1.10	0.69	0.48
270.0	1.27	0.64	0.43
330.0	1.42	0.59	0.38
390.0	1.89	0.54	0.34
470.0	2.21	0.49	0.31
560.0	2.42	0.46	0.28
680.0	2.73	0.43	0.25
820.0	3.78	0.40	0.23
1000.0	4.20	0.37	0.21
1200.0	5.51	0.32	0.19
1500.0	7.35	0.29	0.17
1800.0	8.66	0.25	0.16
2200.0	9.71	0.22	0.14
2700.0	11.29	0.20	0.13
3300.0	15.60	0.18	0.12
3900.0	20.74	0.16	0.11
4700.0	23.10	0.14	0.10

Note

- Contact factory for values above 47 000 μH

DESCRIPTION				
IHSM-5832	3.9 μH	± 15 %	ER	e3
MODEL	INDUCTANCE VALUE	INDUCTANCE TOLERANCE	PACKAGE CODE	JEDEC LEAD (Pb)-FREE STANDARD

GLOBAL PART NUMBER				
I	H	S	M	
PRODUCT FAMILY				
5	8	3	2	
SIZE				
E	R			
PACKAGE CODE				
3	R	9		
INDUCTANCE VALUE				
			L	
				TOL.

FEATURES

- Flame retardant encapsulant (UL 94 V-0)
- Completely encapsulated winding provides superior environmental protection and moisture resistance
- High current unit in surface mount package printed with model, inductance value and date code
- Compatible with infrared or conventional reflow soldering methods
- Pick and place compatible
- Tape and reel packaging for automatic handling
- Compliant to RoHS Directive 2002/95/EC

RoHS
COMPLIANT

APPLICATIONS

Excellent power line noise filters, filters for switching regulated power supplies, DC/DC converters, SCR and triac controls and RFI suppression.

ELECTRICAL SPECIFICATIONS

Inductance: Measured at 1 V with no DC current

Inductance Tolerance: ± 15 %

Incremental Current: The typical current at which the inductance will be decreased by 5 % from its initial zero DC value

Operating Temperature: - 55 °C to + 125 °C (no load); - 55 °C to + 85 °C (at full rated current)

MECHANICAL SPECIFICATIONS

Core: High resistivity ferrite core

Encapsulant: Epoxy

Terminals: 100 % Sn over Ni

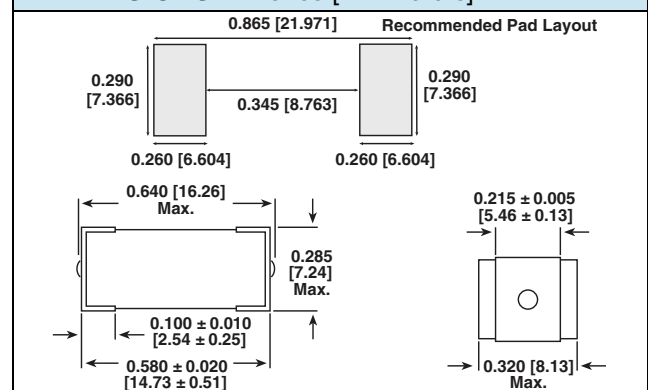
DIMENSIONS in inches [millimeters]

PART MARKING

- Model
- Inductance value
- Date code

High Current, Surface Mount Inductors



STANDARD ELECTRICAL SPECIFICATIONS			
IND. AT 1 kHz (μH)	DCR MAX. (Ω)	RATED CURRENT MAX. (A)	INCREMENTAL CURRENT APPROX. (A)
1.0	0.011	9.0	5.3
1.2	0.012	8.8	4.8
1.5	0.012	8.6	4.4
1.8	0.013	8.5	4.0
2.2	0.014	8.4	3.6
2.7	0.016	8.2	3.2
3.3	0.017	8.1	2.8
3.9	0.02	7.3	2.6
4.7	0.023	6.7	2.4
5.6	0.025	6.0	2.3
6.8	0.028	5.6	2.1
8.2	0.032	5.3	1.9
10.0	0.036	5.0	1.7
12.0	0.04	4.8	1.5
15.0	0.043	4.5	1.4
18.0	0.047	4.2	1.3
22.0	0.054	3.8	1.2
27.0	0.074	3.4	1.1
33.0	0.084	3.0	0.99
39.0	0.095	2.8	0.93
47.0	0.12	2.6	0.87
56.0	0.14	2.4	0.82
68.0	0.16	2.1	0.76
82.0	0.184	1.9	0.72
100.0	0.226	1.7	0.68
120.0	0.305	1.5	0.61
150.0	0.362	1.4	0.54
180.0	0.399	1.3	0.48
220.0	0.536	1.1	0.44
270.0	0.599	0.95	0.4
330.0	0.714	0.86	0.36
390.0	0.819	0.8	0.33
470.0	1.1	0.74	0.31
560.0	1.2	0.68	0.29
680.0	1.58	0.63	0.26
820.0	2.08	0.573	0.23
1000.0	2.42	0.51	0.21
1200.0	2.68	0.46	0.19
1500.0	3.15	0.4	0.17
1800.0	4.2	0.34	0.15
2200.0	4.62	0.31	0.135
2700.0	6.3	0.29	0.12
3300.0	7.09	0.27	0.11
3900.0	9.14	0.25	0.1
4700.0	10.6	0.23	0.09
5600.0	11.8	0.21	0.08
6800.0	15.8	0.19	0.0775
8200.0	21.8	0.17	0.0725
10 000.0	24.6	0.16	0.07
12 000.0	28.4	0.14	0.0625
15 000.0	37.8	0.12	0.055
18 000.0	44.1	0.11	0.05

FEATURES

- Flame retardant encapsulant (UL 94 V-0)
- Completely encapsulated winding provides superior environmental protection and moisture resistance
- High current unit in surface mount package printed with model, inductance value and date code
- Compatible with infrared or conventional reflow soldering methods
- Pick and place compatible
- Compliant to RoHS directive 2002/95/EC

RoHS
COMPLIANT

APPLICATIONS

Excellent power line noise filters, filters for switching regulated power supplies, DC/DC converters, SCR and triac controls and RFI suppression.

ELECTRICAL SPECIFICATIONS

Inductance: Measured at 1 V with no DC current

Inductance Tolerance: ± 15 %

Incremental Current: The typical current at which the inductance will be decreased by 5 % from its initial zero DC value

Operating Temperature: - 55 °C to + 125 °C (no load);
- 55 °C to + 85 °C (at full rated current)

MECHANICAL SPECIFICATIONS

Core: High resistivity ferrite core

Encapsulant: Epoxy

Terminals: 100 % Sn over Ni

DIMENSIONS in inches [millimeters]

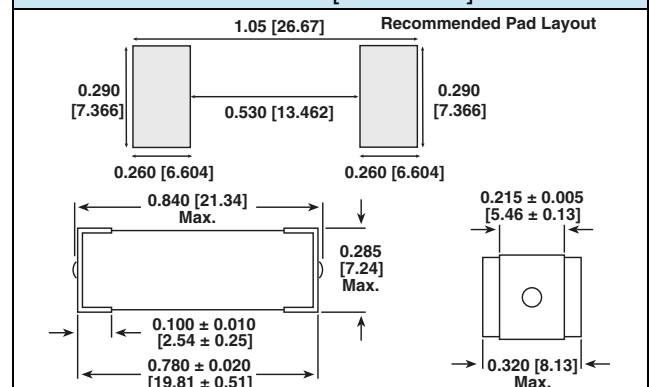

PART MARKING

- Model
- Inductance value
- Date code

DESCRIPTION

IHSM-7832	3.9 μH	± 15 %	ER	e3
MODEL	INDUCTANCE VALUE	INDUCTANCE TOLERANCE	PACKAGE CODE	JEDEC LEAD (Pb)-FREE STANDARD

GLOBAL PART NUMBER

I	H	S	M	7	8	3	2	E	R	3	R	9	L
PRODUCT FAMILY				SIZE				PACKAGE CODE		INDUCTANCE VALUE			TOL.

High Current, Surface Mount Inductors

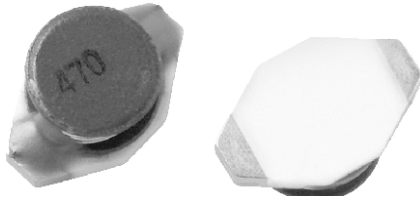

FEATURES

- High energy storage
- Low resistance
- Tape and reel packaging for automatic handling
- Compliant to RoHS Directive 2002/95/EC
- Halogen-free according to IEC 61249-2-21 definition



RoHS
COMPLIANT
HALOGEN
FREE

ELECTRICAL SPECIFICATIONS

Inductance Range: 1.0 μH to 1000 μH , tested at 1.0 V_{RMS}
Inductance Tolerance: 20 %, tighter tolerance available upon request
Operating Temperature: - 40 °C to + 125 °C
Resistance to Solder Heat: 260 °C for 10 s

MECHANICAL SPECIFICATIONS

Core: Ferrite
Wire: Enamelled copper wire
Base: Ceramic
Terminals: Gold over nickel
Adhesive: Epoxy resin

STANDARD ELECTRICAL SPECIFICATIONS					
INDUCTANCE (μH)	TOLERANCE	TEST FREQUENCY L (kHz)	DCR MAX. (Ω)	I_{SAT} (A)	I_{RMS} (A)
1.0	$\pm 20\%$	100	0.05	2.9	2.9
1.5	$\pm 20\%$	100	0.05	2.6	2.8
2.2	$\pm 20\%$	100	0.07	2.3	2.4
3.3	$\pm 20\%$	100	0.08	2.0	2.0
4.7	$\pm 20\%$	100	0.09	1.5	1.5
6.8	$\pm 20\%$	100	0.13	1.2	1.4
10	$\pm 20\%$	100	0.16	1.1	1.1
15	$\pm 20\%$	100	0.23	0.90	1.2
22	$\pm 20\%$	100	0.37	0.70	0.80
33	$\pm 20\%$	100	0.51	0.58	0.60
47	$\pm 20\%$	100	0.64	0.50	0.50
68	$\pm 20\%$	100	0.86	0.40	0.40
100	$\pm 20\%$	100	1.27	0.31	0.30
150	$\pm 20\%$	100	2.00	0.27	0.25
220	$\pm 20\%$	100	3.11	0.22	0.20
330	$\pm 20\%$	100	3.80	0.18	0.16
470	$\pm 20\%$	100	5.06	0.16	0.15
680	$\pm 20\%$	100	9.20	0.14	0.12
1000	$\pm 20\%$	100	13.8	0.10	0.07

Notes

- Inductance drop = 10 % typ. at I_{SAT}
- $\Delta T = 15\text{ }^\circ\text{C}$ typ. at I_{RMS}

DIMENSIONS in inches [millimeters]								
A (Max.)	B (Max.)	D (Max.)	E	F	G	H	I	J
0.260 [6.60]	0.175 [4.45]	0.115 [2.92]	0.050 [1.27]	0.040 [1.02]	0.170 [4.32]	0.055 [1.40]	0.160 [4.06]	0.140 [3.56]

DESCRIPTION				
IDC-2512	10 μH	$\pm 20\%$	ER	e4
MODEL	INDUCTANCE VALUE	INDUCTANCE TOLERANCE	PACKAGE CODE	JEDEC LEAD (Pb)-FREE STANDARD

GLOBAL PART NUMBER				
I	D	C	2	5
PRODUCT FAMILY			SIZE	
E	R	1	0	0
PACKAGE CODE		INDUCTANCE VALUE		
				M
				TOL.

High Current, Surface Mount Inductors

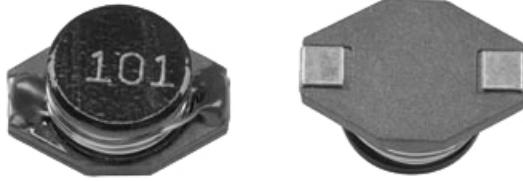

ELECTRICAL SPECIFICATIONS

Inductance Range: 1.0 μH to 1000 μH , tested at 1.0 V_{RMS}
Inductance Tolerance: 20 %, tighter tolerance available upon request
Operating Temperature: - 40 °C to + 125 °C
Resistance to Solder Heat: 260 °C for 10 s

FEATURES

- High energy storage
- Low resistance
- Tape and reel packaging for automatic handling
- Compliant to RoHS Directive 2002/95/EC
- Halogen-free according to IEC 61249-2-21 definition



RoHS
 COMPLIANT
 HALOGEN
FREE

MECHANICAL SPECIFICATIONS

Core: Ferrite
Wire: Enamelled copper wire
Base: LCP
Terminals: Nickel bronze
Adhesive: Epoxy resin

STANDARD ELECTRICAL SPECIFICATIONS

INDUCTANCE (μH)	TOLERANCE	TEST FREQUENCY L (kHz)	DCR MAX. (Ω)	I_{SAT} (A)	I_{RMS} (A)
1.0	$\pm 20 \%$	100	0.009	9.0	6.8
1.5	$\pm 20 \%$	100	0.010	8.0	6.4
2.2	$\pm 20 \%$	100	0.012	7.0	6.1
3.3	$\pm 20 \%$	100	0.015	6.4	5.4
4.7	$\pm 20 \%$	100	0.018	5.4	4.8
6.8	$\pm 20 \%$	100	0.027	4.6	4.4
10	$\pm 20 \%$	100	0.038	3.8	3.9
15	$\pm 20 \%$	100	0.046	3.0	3.1
22	$\pm 20 \%$	100	0.085	2.6	2.7
33	$\pm 20 \%$	100	0.10	2.0	2.1
47	$\pm 20 \%$	100	0.14	1.6	1.8
68	$\pm 20 \%$	100	0.20	1.4	1.5
100	$\pm 20 \%$	100	0.28	1.2	1.3
150	$\pm 20 \%$	100	0.40	1.0	1.0
220	$\pm 20 \%$	100	0.61	0.8	0.8
330	$\pm 20 \%$	100	1.02	0.6	0.6
470	$\pm 20 \%$	100	1.27	0.5	0.5
680	$\pm 20 \%$	100	2.02	0.4	0.4
1000	$\pm 20 \%$	100	3.00	0.3	0.3

Notes

- Inductance drop = 10 % typ. at I_{SAT}
- $\Delta T = 15 \text{ }^\circ\text{C}$ typ. at I_{RMS}

DIMENSIONS in inches [millimeters]



A (Max.)	B (Max.)	D (Max.)	E	F	G	H	I	J
0.510 [12.95]	0.370 [9.40]	0.205 [5.21]	0.100 [2.54]	0.100 [2.54]	0.300 [7.62]	0.115 [2.92]	0.290 [7.37]	0.110 [2.79]

DESCRIPTION

IDC-5020	10 μH	$\pm 20 \%$	ER	e3
MODEL	INDUCTANCE VALUE	INDUCTANCE TOLERANCE	PACKAGE CODE	JEDEC LEAD (Pb)-FREE STANDARD

GLOBAL PART NUMBER

I	D	C	5	0	2	0	E	R	1	0	0	M
PRODUCT FAMILY			SIZE				PACKAGE CODE		INDUCTANCE VALUE			TOL

High Current, Surface Mount Inductors

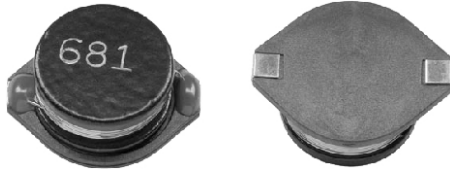

FEATURES

- High energy storage
- Low resistance
- Tape and reel packaging for automatic handling
- Compliant to RoHS Directive 2002/95/EC
- Halogen-free according to IEC 61249-2-21 definition



RoHS
COMPLIANT
HALOGEN
FREE

ELECTRICAL SPECIFICATIONS

Inductance Range: 1.0 μ H to 1000 μ H, tested at 1.0 V_{RMS}
Inductance Tolerance: 20 %, tighter tolerance available upon request
Operating Temperature: - 40 °C to + 125 °C
Resistance to Solder Heat: 260 °C for 10 s

MECHANICAL SPECIFICATIONS

Core: Ferrite
Wire: Enamelled copper wire
Base: LCP
Terminals: Nickel bronze
Adhesive: Epoxy resin

STANDARD ELECTRICAL SPECIFICATIONS					
INDUCTANCE (μ H)	TOLERANCE	TEST FREQUENCY L (kHz)	DCR MAX. (Ω)	I_{SAT} (A)	I_{RMS} (A)
1.0	± 20 %	100	0.009	20.0	8.6
2.2	± 20 %	100	0.014	16.0	7.1
3.3	± 20 %	100	0.018	14.0	6.2
5.6	± 20 %	100	0.020	12.0	5.3
10	± 20 %	100	0.031	10.0	4.3
15	± 20 %	100	0.036	8.0	4.0
22	± 20 %	100	0.047	7.0	3.5
33	± 20 %	100	0.066	5.5	3.0
47	± 20 %	100	0.086	4.5	2.6
68	± 20 %	100	0.13	3.5	2.3
100	± 20 %	100	0.19	3.0	1.8
150	± 20 %	100	0.25	2.6	1.5
220	± 20 %	100	0.38	2.4	1.2
330	± 20 %	100	0.56	1.9	1.0
470	± 20 %	100	0.85	1.4	0.82
680	± 20 %	100	1.1	1.2	0.72
1000	± 20 %	100	1.8	1.0	0.56

Notes

- Inductance drop = 10 % typ. at I_{SAT}
- $\Delta T = 40$ °C typ. at I_{RMS}

DIMENSIONS in inches [millimeters]								
A (Max.)	B (Max.)	D (Max.)	E	F	G	H	I	J
0.730 [18.54]	0.600 [15.24]	0.280 [7.11]	0.100 [2.54]	0.100 [2.54]	0.500 [12.70]	0.115 [2.92]	0.490 [12.45]	0.110 [2.79]

DESCRIPTION				
IDC-7328	10 μH	± 20 %	ER	e3
MODEL	INDUCTANCE VALUE	INDUCTANCE TOLERANCE	PACKAGE CODE	JEDEC LEAD (Pb)-FREE STANDARD

GLOBAL PART NUMBER												
I	D	C	7	3	2	8	E	R	1	0	0	M
PRODUCT FAMILY			SIZE			PACKAGE CODE		INDUCTANCE VALUE			TOL.	

High Current, Shielded, Surface Mount Inductors

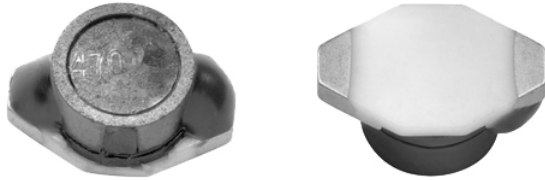
FEATURES

- High energy storage
- Low resistance
- Magnetically shielded
- Tape and reel packaging for automatic handling
- Compliant to RoHS Directive 2002/95/EC
- Halogen-free according to IEC 61249-2-21 definition

RoHS
 COMPLIANT
 HALOGEN
FREE
ELECTRICAL SPECIFICATIONS
Inductance Range: 1.0 μ H to 10 000 μ H, tested at 1.0 V_{RMS}
Inductance Tolerance: 20 %, tighter tolerance available upon request

Operating Temperature: - 40 °C to + 125 °C

Resistance to Solder Heat: 260 °C for 10 s

MECHANICAL SPECIFICATIONS
Core: Ferrite

Wire: Enamelled copper wire

Base: Ceramic

Terminals: Gold over nickel

Adhesive: Epoxy resin

STANDARD ELECTRICAL SPECIFICATIONS

INDUCTANCE (μ H)	TOLERANCE	TEST FREQUENCY L (kHz)	DCR MAX. (Ω)	RATED DC CURRENT (A) ⁽¹⁾
1.0	± 20 %	100	0.040	3.0
1.5	± 20 %	100	0.045	2.8
2.2	± 20 %	100	0.050	1.8
3.3	± 20 %	100	0.055	1.6
4.7	± 20 %	100	0.060	1.4
6.8	± 20 %	100	0.065	1.2
10	± 20 %	100	0.075	1.0
15	± 20 %	100	0.090	0.80
22	± 20 %	100	0.11	0.70
33	± 20 %	100	0.19	0.60
47	± 20 %	100	0.23	0.50
68	± 20 %	100	0.29	0.40
100	± 20 %	100	0.48	0.30
150	± 20 %	100	0.59	0.26
220	± 20 %	100	0.77	0.22
330	± 20 %	100	1.4	0.20
470	± 20 %	100	1.8	0.19
680	± 20 %	100	2.2	0.18
1000	± 20 %	100	3.4	0.15
1500	± 20 %	100	4.2	0.12
2200	± 20 %	100	8.5	0.10
3300	± 20 %	100	11.0	0.08
4700	± 20 %	100	13.9	0.06
6800	± 20 %	100	25.0	0.04
10 000	± 20 %	100	32.8	0.02

Notes
⁽¹⁾ 30 °C temperature rise

DIMENSIONS in inches [millimeters]

A (Max.)	B (Max.)	D (Max.)	E	F	G	H	I	J
0.260 [6.60]	0.175 [4.45]	0.115 [2.92]	0.050 [1.27]	0.040 [1.02]	0.170 [4.32]	0.055 [1.40]	0.160 [4.06]	0.140 [3.56]

DESCRIPTION

IDCS-2512	10 μH	± 20 %	ER	e4
MODEL	INDUCTANCE VALUE	INDUCTANCE TOLERANCE	PACKAGE CODE	JEDEC LEAD (Pb)-FREE STANDARD

GLOBAL PART NUMBER

I	D	C	S	2	5	1	2	E	R	1	0	0	M
PRODUCT FAMILY				SIZE				PACKAGE CODE		INDUCTANCE VALUE			INDUCTANCE TOLERANCE

High Current, Shielded, Surface Mount Inductors



FEATURES

- High energy storage
- Low resistance
- Magnetically shielded
- Tape and reel packaging for automatic handling
- Compliant to RoHS Directive 2002/95/EC
- Halogen-free according to IEC 61249-2-21 definition



RoHS
COMPLIANT
HALOGEN
FREE

ELECTRICAL SPECIFICATIONS

Inductance Range: 1.0 μH to 390.0 μH , tested at 1.0 V_{RMS}

Inductance Tolerance: 20 %, tighter tolerance available upon request

Operating Temperature: - 40 °C to + 125 °C

Resistance to Solder Heat: 260 °C for 10 s

MECHANICAL SPECIFICATIONS

Core: Ferrite

Wire: Enamelled copper wire

Base: LCP

Terminals: Nickel bronze

Adhesive: Epoxy resin

STANDARD ELECTRICAL SPECIFICATIONS

INDUCTANCE (μH)	TOLERANCE	TEST FREQUENCY L (kHz)	DCR MAX. (Ω)	I_{SAT} (A)	I_{RMS} (A)
1.0	$\pm 20\%$	100	0.021	5.6	5.0
1.5	$\pm 20\%$	100	0.022	5.2	4.5
2.2	$\pm 20\%$	100	0.032	5.0	3.8
3.3	$\pm 20\%$	100	0.039	3.9	3.3
4.7	$\pm 20\%$	100	0.054	3.2	2.7
6.8	$\pm 20\%$	100	0.075	2.8	2.2
10	$\pm 20\%$	100	0.101	2.4	2.0
15	$\pm 20\%$	100	0.150	2.0	1.5
22	$\pm 20\%$	100	0.207	1.6	1.3
33	$\pm 20\%$	100	0.334	1.4	1.1
47	$\pm 20\%$	100	0.472	1.0	0.80
56	$\pm 20\%$	100	0.210	0.95	0.90
68	$\pm 20\%$	100	0.340	0.90	0.82
82	$\pm 20\%$	100	0.380	0.85	0.75
100	$\pm 20\%$	100	0.420	0.80	0.68
120	$\pm 20\%$	100	0.460	0.70	0.60
150	$\pm 20\%$	100	0.520	0.60	0.55
180	$\pm 20\%$	100	0.700	0.65	0.50
220	$\pm 20\%$	100	0.800	0.50	0.45
270	$\pm 20\%$	100	1.100	0.45	0.40
330	$\pm 20\%$	100	1.200	0.40	0.35
390	$\pm 20\%$	100	1.400	0.35	0.33

Notes

- Inductance drop = 10 % typ. at I_{SAT}
- $\Delta T = 15\text{ }^\circ\text{C}$ typ. at I_{RMS}

DIMENSIONS in inches [millimeters]

A (Max.)	B (Max.)	D (Max.)	E	F	G	H	I	J
0.510 [12.95]	0.370 [9.40]	0.200 [5.08]	0.100 [2.54]	0.100 [2.54]	0.300 [7.62]	0.115 [2.92]	0.290 [7.37]	0.110 [2.79]

DESCRIPTION

IDCS-5020	10 μH	$\pm 20\%$	ER	e3
MODEL	INDUCTANCE VALUE	INDUCTANCE TOLERANCE	PACKAGE CODE	JEDEC LEAD (Pb)-FREE STANDARD

GLOBAL PART NUMBER

I	D	C	S	5	0	2	0	E	R	1	0	0	M
PRODUCT FAMILY				SIZE				PACKAGE CODE		INDUCTANCE VALUE			INDUCTANCE TOLERANCE

High Current, Shielded, Surface Mount Inductors



FEATURES

- High energy storage
- Low resistance
- Magnetically shielded
- Tape and reel packaging for automatic handling
- Compliant to RoHS Directive 2002/95/EC
- Halogen-free according to IEC 61249-2-21 definition



RoHS
COMPLIANT
HALOGEN
FREE

ELECTRICAL SPECIFICATIONS

Inductance Range: 10 μH to 1000 μH , tested at 1.0 V_{RMS}
Inductance Tolerance: 20 %, tighter tolerance available upon request
Operating Temperature: - 40 °C to + 125 °C
Resistance to Solder Heat: 260 °C for 10 s

MECHANICAL SPECIFICATIONS

Core: Ferrite
Wire: Enamelled copper wire
Base: LCP
Terminals: Nickel bronze
Adhesive: Epoxy resin

STANDARD ELECTRICAL SPECIFICATIONS					
INDUCTANCE (μH)	TOLERANCE	TEST FREQUENCY L (kHz)	DCR MAX. (Ω)	I_{SAT} (A)	I_{RMS} (A)
10	$\pm 20\%$	100	0.040	8.0	3.9
15	$\pm 20\%$	100	0.048	7.0	3.4
22	$\pm 20\%$	100	0.059	6.0	3.1
33	$\pm 20\%$	100	0.075	5.0	2.8
47	$\pm 20\%$	100	0.097	4.0	2.4
68	$\pm 20\%$	100	0.138	3.0	2.0
100	$\pm 20\%$	100	0.207	2.4	1.7
150	$\pm 20\%$	100	0.293	2.1	1.3
220	$\pm 20\%$	100	0.47	1.9	1.1
330	$\pm 20\%$	100	0.78	1.1	0.86
470	$\pm 20\%$	100	1.08	1.1	0.73
680	$\pm 20\%$	100	1.40	0.96	0.64
1000	$\pm 20\%$	100	2.01	0.80	0.53

Notes

- Inductance drop = 10 % typ. at I_{SAT}
- $\Delta T = 40$ °C typ. at I_{RMS}

DIMENSIONS in inches [millimeters]								
A (Max.)	B (Max.)	D (Max.)	E	F	G	H	I	J
0.730 [18.54]	0.600 [15.24]	0.300 [7.62]	0.100 [2.54]	0.100 [2.54]	0.500 [12.70]	0.115 [2.92]	0.490 [12.45]	0.110 [2.79]

DESCRIPTION				
IDCS-7328	10 μH	$\pm 20\%$	ER	e3
MODEL	INDUCTANCE VALUE	INDUCTANCE TOLERANCE	PACKAGE CODE	JEDEC LEAD (Pb)-FREE STANDARD

GLOBAL PART NUMBER				
I	D	C	S	
PRODUCT FAMILY				
7	3	2	8	
SIZE				
E	R			
PACKAGE CODE				
1	0	0		
INDUCTANCE VALUE				
			M	
				INDUCTANCE TOLERANCE

High Current, Surface Mount Inductors

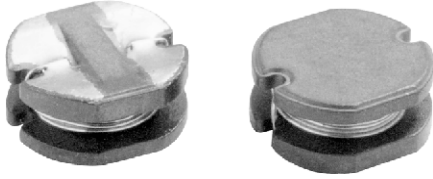

FEATURES

- High energy storage
- Low resistance
- Tape and reel packaging for automatic handling
- Compliant to RoHS Directive 2002/95/EC
- Halogen-free according to IEC 61249-2-21 definition



RoHS
COMPLIANT
HALOGEN
FREE

ELECTRICAL SPECIFICATIONS

Inductance Range: 1.0 μ H to 68 μ H

Inductance Tolerance: 20 %

Operating Temperature: - 25 °C to + 105 °C

Storage Temperature: - 40 °C to + 125 °C

Resistance to Solder Heat: 260 °C for 10 s

MATERIALS

Core: Ferrite

Wire: Enamelled copper wire

Terminals: Ag and Sn/Ag/Cu

STANDARD ELECTRICAL SPECIFICATIONS			
INDUCTANCE (μ H)	TEST FREQUENCY L	DCR MAX. (Ω)	RATED DC CURRENT (A) ⁽¹⁾
1.0	7.96 MHz	0.033	3.80
1.4	7.96 MHz	0.038	3.30
1.8	7.96 MHz	0.042	2.91
2.2	7.96 MHz	0.047	2.60
2.7	7.96 MHz	0.052	2.43
3.3	7.96 MHz	0.058	2.15
3.9	7.96 MHz	0.076	1.98
4.7	7.96 MHz	0.094	1.70
5.6	7.96 MHz	0.101	1.60
6.8	7.96 MHz	0.117	1.41
8.2	7.96 MHz	0.132	1.26
10.0	2.52 MHz	0.182	1.15
12.0	2.52 MHz	0.210	1.05
15.0	2.52 MHz	0.235	0.92
18.0	2.52 MHz	0.338	0.84
22.0	2.52 MHz	0.378	0.76
27.0	2.52 MHz	0.522	0.71
33.0	2.52 MHz	0.540	0.64
39.0	2.52 MHz	0.587	0.59
47.0	2.52 MHz	0.844	0.54
56.0	2.52 MHz	0.937	0.50
68.0	2.52 MHz	1.117	0.46

Note

⁽¹⁾ Rated Current: Value obtained when current flows and the temperature has risen 40 °C or when DC current flows and the initial value of inductance has fallen by 10 %, whichever is smaller.

DIMENSIONS in inches [millimeters]		
<p>TYPICAL PAD LAYOUT</p>		
A	B	C
0.178 ± 0.01 [4.5 ± 0.3]	0.126 ± 0.01 [3.2 ± 0.3]	0.158 ± 0.01 [4.0 ± 0.3]
D	E	F
0.178 [4.5]	0.069 [1.75]	0.059 [1.5]

DESCRIPTION				
IDCP-1813	10 μH	± 20 %	ER	e1
MODEL	INDUCTANCE VALUE	INDUCTANCE TOLERANCE	PACKAGE CODE	JEDEC LEAD (Pb)-FREE STANDARD

GLOBAL PART NUMBER				
I	D	C	P	
PRODUCT FAMILY				
1	8	1	3	
SIZE				
E	R			
PACKAGE CODE				
1	0	0		
INDUCTANCE VALUE				
		M		
			INDUCTANCE TOLERANCE	

High Current, Surface Mount Inductors

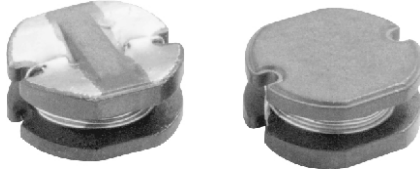

ELECTRICAL SPECIFICATIONS

Inductance Range: 10 μ H to 220 μ H

Inductance Tolerance: 20 %

Operating Temperature: - 25 °C to + 105 °C

Storage Temperature: - 40 °C to + 125 °C

Resistance to Solder Heat: 260 °C for 10 s

FEATURES

- High energy storage
- Low resistance
- Tape and reel packaging for automatic handling
- Compliant to RoHS Directive 2002/95/EC
- Halogen-free according to IEC 61249-2-21 definition



RoHS
COMPLIANT
HALOGEN
FREE

MATERIALS

Core: Ferrite

Wire: Enamelled copper wire

Terminals: Ni and Sn/Ag/Cu

STANDARD ELECTRICAL SPECIFICATIONS			
INDUCTANCE (μ H)	TEST FREQUENCY L	DCR MAX. (Ω)	RATED DC CURRENT (A) ⁽¹⁾
10.0	2.52 MHz	0.10	1.44
12.0	2.52 MHz	0.12	1.40
15.0	2.52 MHz	0.14	1.30
18.0	2.52 MHz	0.15	1.23
22.0	2.52 MHz	0.18	1.11
27.0	2.52 MHz	0.20	0.97
33.0	2.52 MHz	0.23	0.88
39.0	2.52 MHz	0.32	0.80
47.0	2.52 MHz	0.37	0.72
56.0	2.52 MHz	0.42	0.68
68.0	2.52 MHz	0.46	0.61
82.0	2.52 MHz	0.60	0.58
100.0	1 kHz	0.70	0.52
120.0	1 kHz	0.93	0.48
150.0	1 kHz	1.10	0.40
180.0	1 kHz	1.38	0.38
220.0	1 kHz	1.57	0.35

Note

⁽¹⁾ Rated Current: Value obtained when current flows and the temperature has risen 40 °C or when DC current flows and the initial value of inductance has fallen by 10 %, whichever is smaller.

DIMENSIONS in inches [millimeters]		
A	B	C
0.229 ± 0.01 [5.8 ± 0.3]	0.177 ± 0.01 [4.5 ± 0.3]	0.205 ± 0.01 [5.2 ± 0.3]
D	E	F
0.217 [5.5]	0.085 [2.15]	0.067 [1.7]

DESCRIPTION				
IDCP-2218	10 μ H	± 20 %	ER	e1
MODEL	INDUCTANCE VALUE	INDUCTANCE TOLERANCE	PACKAGE CODE	JEDEC LEAD (Pb)-FREE STANDARD

GLOBAL PART NUMBER				
I	D	C	P	
PRODUCT FAMILY				
2	2	1	8	
SIZE				
E	R			
PACKAGE CODE				
1	0	0		
INDUCTANCE VALUE				
			M	
			INDUCTANCE TOLERANCE	

High Current, Surface Mount Inductors

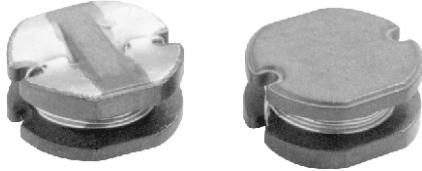

ELECTRICAL SPECIFICATIONS

Inductance Range: 10 μ H to 470 μ H
Inductance Tolerance: 20 %
Operating Temperature: - 25 °C to + 105 °C
Storage Temperature: - 40 °C to + 125 °C
Resistance to Solder Heat: 260 °C for 10 s

STANDARD ELECTRICAL SPECIFICATIONS			
INDUCTANCE (μ H)	TEST FREQUENCY L	DCR MAX. (Ω)	RATED DC CURRENT (A) ⁽¹⁾
10.0	2.52 MHz	0.07	2.30
12.0	2.52 MHz	0.08	2.00
15.0	2.52 MHz	0.09	1.80
18.0	2.52 MHz	0.10	1.60
22.0	2.52 MHz	0.11	1.50
27.0	2.52 MHz	0.12	1.30
33.0	2.52 MHz	0.13	1.20
39.0	2.52 MHz	0.16	1.10
47.0	2.52 MHz	0.18	1.10
56.0	2.52 MHz	0.24	0.94
68.0	2.52 MHz	0.28	0.85
82.0	2.52 MHz	0.37	0.78
100.0	1 kHz	0.43	0.72
120.0	1 kHz	0.47	0.66
150.0	1 kHz	0.64	0.58
180.0	1 kHz	0.71	0.51
220.0	1 kHz	0.96	0.49
270.0	1 kHz	1.11	0.42
330.0	1 kHz	1.26	0.40
390.0	1 kHz	1.77	0.36
470.0	1 kHz	1.96	0.34

Note

⁽¹⁾ Rated Current: Value obtained when current flows and the temperature has risen 40 °C or when DC current flows and the initial value of inductance has fallen by 10 %, whichever is smaller.

FEATURES

- High energy storage
- Low resistance
- Tape and reel packaging for automatic handling
- Compliant to RoHS Directive 2002/95/EC
- Halogen-free according to IEC 61249-2-21 definition



RoHS
 COMPLIANT
 HALOGEN
FREE

MATERIALS

Core: Ferrite
Wire: Enamelled copper wire
Terminals: Ni and Sn/Ag/Cu

DIMENSIONS in inches [millimeters]

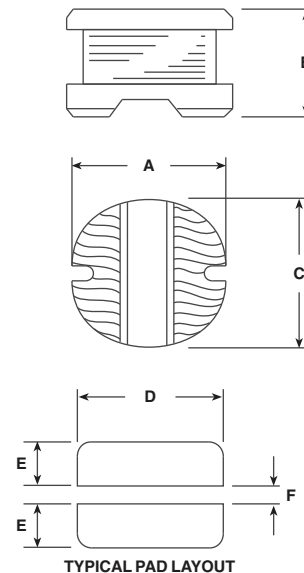

A	B	C
0.307 ± 0.01 [7.8 ± 0.3]	0.197 ± 0.02 [5.0 ± 0.5]	0.276 ± 0.01 [7.0 ± 0.3]
D	E	F
0.296 [7.5]	0.118 [3.0]	0.079 [2.0]

DESCRIPTION

IDCP-3020	10 μ H	± 20 %	ER	e1
MODEL	INDUCTANCE VALUE	INDUCTANCE TOLERANCE	PACKAGE CODE	JEDEC LEAD (Pb)-FREE STANDARD

GLOBAL PART NUMBER

I	D	C	P	3	0	2	0	E	R	1	0	0	M
PRODUCT FAMILY				SIZE				PACKAGE CODE		INDUCTANCE VALUE			INDUCTANCE TOLERANCE

High Current, Surface Mount Inductors



ELECTRICAL SPECIFICATIONS

Inductance Range: 10 μ H to 330 μ H
Inductance Tolerance: 20 %
Operating Temperature: - 25 °C to + 105 °C
Storage Temperature: - 40 °C to + 125 °C
Resistance to Solder Heat: 260 °C for 10 s

FEATURES

- High energy storage
- Low resistance
- Tape and reel packaging for automatic handling
- Compliant to RoHS Directive 2002/95/EC
- Halogen-free according to IEC 61249-2-21 definition



RoHS
 COMPLIANT
 HALOGEN
FREE

MATERIALS

Core: Ferrite
Wire: Enamelled copper wire
Terminals: Ni and Sn/Ag/Cu

STANDARD ELECTRICAL SPECIFICATIONS			
INDUCTANCE (μ H)	TEST FREQUENCY L	DCR MAX. (Ω)	RATED DC CURRENT (A) ⁽¹⁾
10.0	2.52 MHz	0.08	1.44
12.0	2.52 MHz	0.09	1.39
15.0	2.52 MHz	0.10	1.24
18.0	2.52 MHz	0.11	1.12
22.0	2.52 MHz	0.13	1.07
27.0	2.52 MHz	0.15	0.94
33.0	2.52 MHz	0.17	0.85
39.0	2.52 MHz	0.22	0.74
47.0	2.52 MHz	0.25	0.68
56.0	2.52 MHz	0.28	0.64
68.0	2.52 MHz	0.33	0.59
82.0	2.52 MHz	0.41	0.54
100.0	1 kHz	0.48	0.51
120.0	1 kHz	0.54	0.49
150.0	1 kHz	0.75	0.40
180.0	1 kHz	1.02	0.36
220.0	1 kHz	1.20	0.31
270.0	1 kHz	1.31	0.29
330.0	1 kHz	1.50	0.28

Note

⁽¹⁾ Rated Current: Value obtained when current flows and the temperature has risen 40 °C or when DC current flows and the initial value of inductance has fallen by 10 %, whichever is smaller.

DIMENSIONS in inches [millimeters]

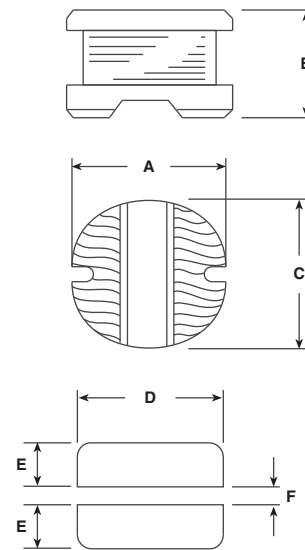

A	B	C
0.307 ± 0.01 [7.8 ± 0.3]	0.138 ± 0.02 [3.5 ± 0.5]	0.276 ± 0.01 [7.0 ± 0.3]
D	E	F
0.296 [7.5]	0.118 [3.0]	0.079 [2.0]

DESCRIPTION

IDCP-3114	10 μH	± 20 %	ER	e1
MODEL	INDUCTANCE VALUE	INDUCTANCE TOLERANCE	PACKAGE CODE	JEDEC LEAD (Pb)-FREE STANDARD

GLOBAL PART NUMBER

I	D	C	P	3	1	1	4	E	R	1	0	0	M
PRODUCT FAMILY				SIZE				PACKAGE CODE		INDUCTANCE VALUE			INDUCTANCE TOLERANCE

High Current, Surface Mount Inductors

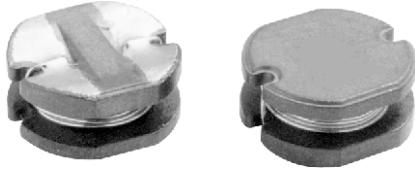

FEATURES

- High energy storage
- Low resistance
- Tape and reel packaging for automatic handling
- Compliant to RoHS Directive 2002/95/EC
- Halogen-free according to IEC 61249-2-21 definition



RoHS
COMPLIANT
HALOGEN
FREE

ELECTRICAL SPECIFICATIONS

Inductance Range: 10 μ H to 820 μ H

Inductance Tolerance: 20 %

Operating Temperature: - 25 °C to + 105 °C

Storage Temperature: - 40 °C to + 125 °C

Resistance to Solder Heat: 260 °C for 10 s

MATERIALS

Core: Ferrite

Wire: Enamelled copper wire

Terminals: Ni and Sn/Ag/Cu

STANDARD ELECTRICAL SPECIFICATIONS			
INDUCTANCE (μ H)	TEST FREQUENCY L	DCR MAX. (Ω)	RATED DC CURRENT (A) ⁽¹⁾
10.0	2.52 MHz	0.06	2.60
12.0	2.25 MHz	0.07	2.45
15.0	2.25 MHz	0.08	2.27
18.0	2.25 MHz	0.09	2.15
22.0	2.25 MHz	0.10	1.95
27.0	2.25 MHz	0.11	1.76
33.0	2.25 MHz	0.12	1.50
39.0	2.25 MHz	0.14	1.37
47.0	2.25 MHz	0.17	1.28
56.0	2.25 MHz	0.19	1.17
68.0	2.25 MHz	0.22	1.11
82.0	2.25 MHz	0.25	1.00
100.0	1 kHz	0.35	0.97
120.0	1 kHz	0.40	0.89
150.0	1 kHz	0.47	0.78
180.0	1 kHz	0.63	0.72
220.0	1 kHz	0.73	0.66
270.0	1 kHz	0.97	0.57
330.0	1 kHz	1.15	0.52
390.0	1 kHz	1.30	0.48
470.0	1 kHz	1.48	0.42
560.0	1 kHz	1.90	0.33
680.0	1 kHz	2.25	0.28
820.0	1 kHz	2.55	0.24

Note

⁽¹⁾ Rated Current: Value obtained when current flows and the temperature has risen 40 °C or when DC current flows and the initial value of inductance has fallen by 10 %, whichever is smaller.

DIMENSIONS in inches [millimeters]		
A	B	C
0.394 ± 0.02 [10.0 ± 0.4]	0.213 ± 0.02 [5.4 ± 0.4]	0.355 ± 0.02 [9.0 ± 0.4]
D	E	F
0.374 [9.5]	0.148 [3.75]	0.099 [2.5]

DESCRIPTION				
IDCP-3722	10 μH	± 20 %	ER	e1
MODEL	INDUCTANCE VALUE	INDUCTANCE TOLERANCE	PACKAGE CODE	JEDEC LEAD (Pb)-FREE STANDARD

GLOBAL PART NUMBER				
I	D	C	P	
PRODUCT FAMILY				
3	7	2	2	
SIZE				
E	R			
PACKAGE CODE				
1	0	0		
INDUCTANCE VALUE				
			M	
				INDUCTANCE TOLERANCE

High Current, Surface Mount Inductors

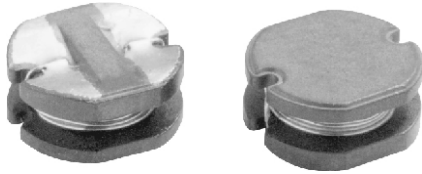

FEATURES

- High energy storage
- Low resistance
- Tape and reel packaging for automatic handling
- Compliant to RoHS Directive 2002/95/EC
- Halogen-free according to IEC 61249-2-21 definition



RoHS
COMPLIANT
HALOGEN
FREE

ELECTRICAL SPECIFICATIONS

Inductance Range: 10 μ H to 560 μ H

Inductance Tolerance: 20 %

Operating Temperature: - 25 °C to + 105 °C

Storage Temperature: - 40 °C to + 125 °C

Resistance to Solder Heat: 260 °C for 10 s

MATERIALS

Core: Ferrite

Wire: Enamelled copper wire

Terminals: Ni and Sn/Ag/Cu

STANDARD ELECTRICAL SPECIFICATIONS			
INDUCTANCE (μ H)	TEST FREQUENCY L	DCR MAX. (Ω)	RATED DC CURRENT (A) ⁽¹⁾
10.0	2.52 MHz	0.05	2.38
12.0	2.52 MHz	0.06	2.13
15.0	2.52 MHz	0.07	1.87
18.0	2.52 MHz	0.08	1.73
22.0	2.52 MHz	0.09	1.60
27.0	2.52 MHz	0.10	1.44
33.0	2.52 MHz	0.12	1.26
39.0	2.52 MHz	0.15	1.20
47.0	2.52 MHz	0.17	1.10
56.0	2.52 MHz	0.20	1.01
68.0	2.52 MHz	0.22	0.91
82.0	2.52 MHz	0.25	0.85
100.0	1 kHz	0.34	0.74
120.0	1 kHz	0.40	0.69
150.0	1 kHz	0.54	0.61
180.0	1 kHz	0.62	0.56
220.0	1 kHz	0.72	0.53
270.0	1 kHz	0.95	0.45
330.0	1 kHz	1.10	0.42
390.0	1 kHz	1.24	0.38
470.0	1 kHz	1.53	0.35
560.0	1 kHz	1.90	0.32

Note

⁽¹⁾ Rated Current: Value obtained when current flows and the temperature has risen 40 °C or when DC current flows and the initial value of inductance has fallen by 10 %, whichever is smaller.

DIMENSIONS in inches [millimeters]		
A	B	C
0.394 \pm 0.01 [10.0 \pm 0.3]	0.158 \pm 0.02 [4.0 \pm 0.5]	0.355 \pm 0.01 [9.0 \pm 0.3]
D	E	F
0.374 [9.5]	0.148 [3.75]	0.099 [2.5]

DESCRIPTION				
IDCP-3916	10 μ H	\pm 20 %	ER	e1
MODEL	INDUCTANCE VALUE	INDUCTANCE TOLERANCE	PACKAGE CODE	JEDEC LEAD (Pb)-FREE STANDARD

GLOBAL PART NUMBER													
I	D	C	P	3	9	1	6	E	R	1	0	0	M
PRODUCT FAMILY				SIZE				PACKAGE CODE		INDUCTANCE VALUE			INDUCTANCE TOLERANCE



High Frequency Inductors

Contents

IFCB-0402.....	167
IFCB-0603.....	168
ILC-0402	169
ILC-0603	170
ILC-0805	171
IMC-0402	172
IMC-0603	173

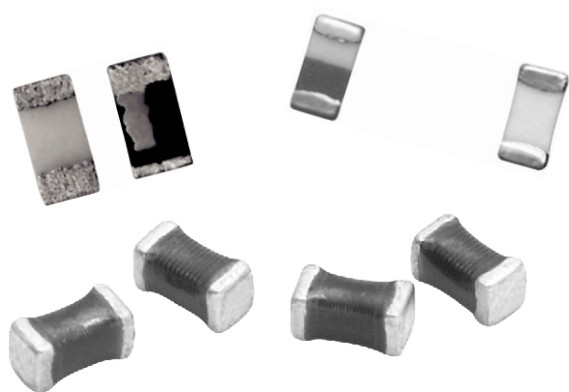

Thin Film Chip Inductors

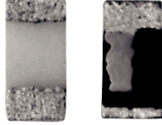

FEATURES

- Tight tolerance
- Self-resonant frequency controlled within 10 %
- Stable inductance over high frequencies
- Compatible with reflow or flow soldering
- Temperature range: - 40 °C to + 125 °C (no load)
- 40 °C to + 85 °C (full rated current)
- Compliant to RoHS directive 2002/95/EC



STANDARD ELECTRICAL SPECIFICATIONS

L 500 MHz (nH)	L TOL.	Q TYPICAL			SRF TYP. (MHz)	DCR MAX. (Ω)	RATED DC CURRENT (mA)
		100 MHz	800 MHz	1700 MHz			
1.0	0.3 nH	7	21	33	12 000	0.15	700
1.2	0.3 nH	7	21	33	12 000	0.15	700
1.5	0.3 nH	7	21	33	10 000	0.25	700
1.8	0.3 nH	7	21	33	10 000	0.25	560
2.2	0.3 nH	7	21	33	8000	0.35	440
2.7	0.3 nH	7	21	33	8000	0.35	440
3.3	0.3 nH	7	21	28	6000	0.45	380
3.9	0.3 nH	7	21	28	6000	0.55	340
4.7	0.3 nH	7	21	28	6000	0.65	320
5.6	0.3 nH	7	21	28	6000	0.85	280
6.8	0.3 nH	7	21	28	6000	1.05	260
8.2	0.3 nH	7	21	28	5500	1.25	220
10	2 %, 5 %	7	21	26	4500	1.35	200
12	2 %, 5 %	5	21	26	3700	1.55	180
15	2 %, 5 %	5	21	26	3300	1.75	130
18	2 %, 5 %	5	21	21	3100	2.15	100
22	2 %, 5 %	5	21	19	2800	2.65	90

Note

- Test equipment: HP-4287 and Agilent 16196B

DIMENSIONS in inches [millimeters]

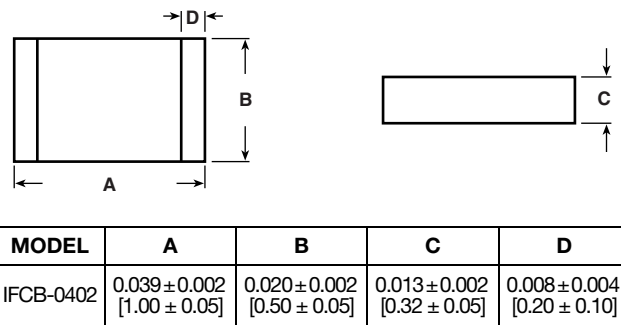

PERFORMANCE GRAPHS: INDUCTANCE AND Q VS. FREQUENCY

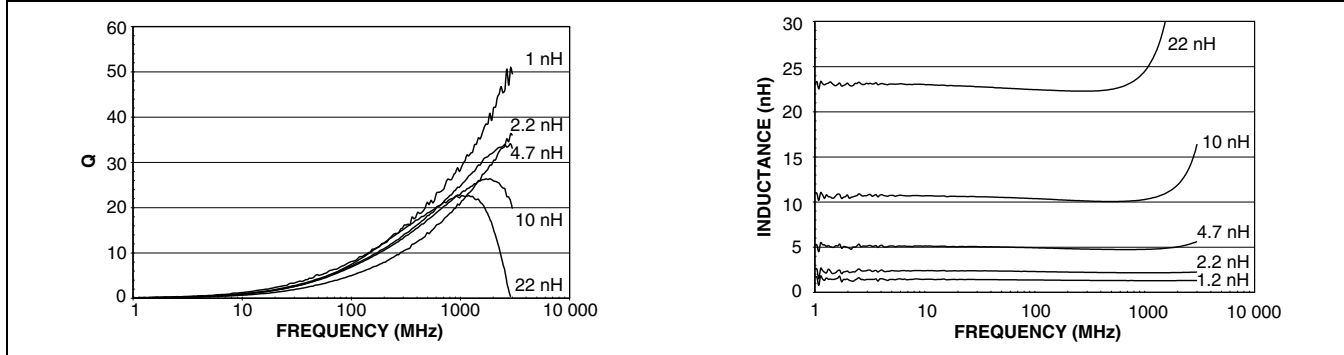

DESCRIPTION

IFCB-0402	10 nH	± 5 %	ER	e3
MODEL	INDUCTANCE VALUE	INDUCTANCE TOLERANCE	PACKAGE CODE	JEDEC LEAD (Pb)-FREE STANDARD

GLOBAL PART NUMBER

I	F	C	B	0	4	0	2	E	R	1	0	N	J
PRODUCT FAMILY				SIZE				PACKAGE CODE		INDUCTANCE VALUE			TOL.

Thin Film Chip Inductors

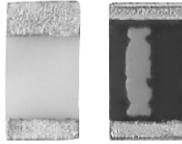

FEATURES

- Tight tolerance
- Self-resonant frequency controlled within 10 %
- Stable inductance over high frequencies
- Compatible with reflow or flow soldering
- Temperature range: - 40 °C to + 125 °C (no load)
- 40 °C to + 85 °C (full rated current)
- Compliant to RoHS directive 2002/95/EC



APPLICATIONS

- Cellular telephone, pagers and GPS products
- Wireless LAN and other communication appliances
- VCO, TCXO circuit and RF transceiver module

STANDARD ELECTRICAL SPECIFICATIONS							
L 500 MHz (nH)	L TOL.	Q TYPICAL			SRF TYP. (MHz)	DCR MAX. (Ω)	RATED DC CURRENT (mA)
		100 MHz	800 MHz	1700 MHz			
1.0	0.3 nH	13	34	49	13 000	0.35	800
1.2	0.3 nH	13	34	49	13 000	0.35	800
1.5	0.3 nH	13	34	49	10 000	0.35	800
1.8	0.3 nH	13	34	49	10 000	0.35	300
2.2	0.3 nH	13	34	49	8000	0.35	300
2.7	0.3 nH	13	34	49	6000	0.45	300
3.3	0.3 nH	13	34	49	6000	0.45	300
3.9	0.3 nH	13	34	49	6000	0.45	300
4.7	0.3 nH	13	34	41	5000	0.55	300
5.6	0.3 nH	13	34	41	5000	0.65	300
6.8	0.3 nH	13	34	41	5000	0.75	300
8.2	0.3 nH	13	34	41	4000	0.95	300
10	2 %, 5 %	13	34	30	4000	0.95	300
12	2 %, 5 %	13	30	30	3000	1.05	300
15	2 %, 5 %	13	30	30	3000	1.35	300
18	2 %, 5 %	13	30	25	2000	1.65	300
22	2 %, 5 %	13	30	25	2000	1.95	250
27	2 %, 5 %	10	45	25	2000	2.35	250
33	2 %, 5 %	10	45	6	1500	2.75	250
39	2 %, 5 %	10	45	1	1500	3.00	200
47	2 %, 5 %	10	45	1	1500	3.00	200
56	2 %, 5 %	10	26	4	1000	5.00	150
68	2 %, 5 %	10	26	6	1000	5.00	150

DIMENSIONS in inches [millimeters]

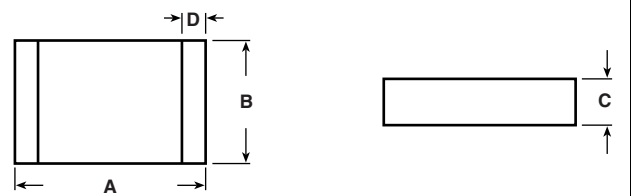

MODEL	A	B	C	D
IFCB-0603	0.063±0.004 [1.60 ± 0.10]	0.031±0.004 [0.80 ± 0.10]	0.018±0.004 [0.45 ± 0.10]	0.012±0.008 [0.30 ± 0.20]

PERFORMANCE GRAPHS: INDUCTANCE AND Q VS. FREQUENCY

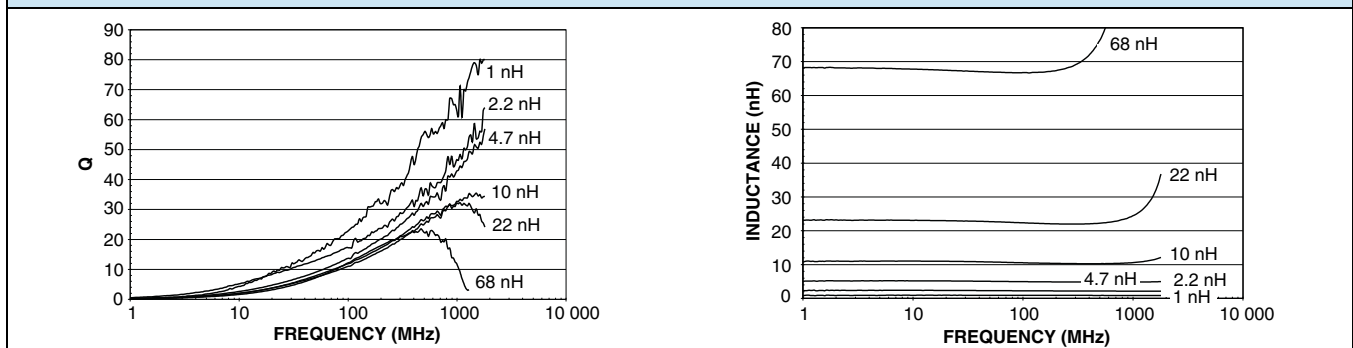

DESCRIPTION

IFCB-0603	10 nH	± 5 %	ER	e3
MODEL	INDUCTANCE VALUE	INDUCTANCE TOLERANCE	PACKAGE CODE	JEDEC LEAD (Pb)-FREE STANDARD

GLOBAL PART NUMBER

I	F	C	B	0	6	0	3	E	R	1	0	N	J
PRODUCT FAMILY				SIZE				PACKAGE CODE		INDUCTANCE VALUE			TOL.

Surface Mount, Multi Layer High Frequency Ceramic Inductors



MECHANICAL SPECIFICATIONS

Solderability: 90 % coverage after 5 s dip in 235 °C solder following 60 s preheat at 120 °C and type R flux dip

Resistance to Solder Heat: 10 s in 260 °C solder, after preheat and flux above

Terminal Strength: 0.2 kg (0.44 lbs) for 30 s

Beam Strength: 0.2 kg (0.44 lbs)

Flex: 0.0788" [2.0 mm] min. mounted on 0.063" [1.6 mm] thick PC board

FEATURES

- High reliability
- Surface mountable
- Reflow or wave solderable
- Tape and reel packaging per EIA specifications: 4000 pieces on 7" reel
- Compliant to RoHS Directive 2002/95/EC
- Halogen-free according to IEC 61249-2-21 definition



RoHS
COMPLIANT
HALOGEN
FREE

ENVIRONMENTAL SPECIFICATIONS

Operating Temperature: - 55 °C to 125 °C

Thermal Shock: 100 cycles, - 40 °C to + 85 °C

Humidity: + 40 °C, 85 % RH, 1000 h at full rated current

Load Life: 85 °C for 1000 h at full rated current

STANDARD ELECTRICAL SPECIFICATIONS

PART NUMBER	IND. (nH)	TOL.	TEST FREQUENCY (MHz)	Q MIN.	Q TYPICAL			SRF (MHz)		DCR MAX. (Ω)	RATED DC CURRENT MAX. (mA)
					100 MHz	500 MHz	1000 MHz	MIN.	TYP.		
ILC0402ER1N0S	1.0	0.3 nH	100	8	10	21	30	10 000	18 000	0.12	300
ILC0402ER1N2S	1.2	0.3 nH	100	8	10	23	31	10 000	17 000	0.12	300
ILC0402ER1N5S	1.5	0.3 nH	100	8	10	25	35	6000	11 000	0.13	300
ILC0402ER1N8S	1.8	0.3 nH	100	8	10	25	35	6000	11 000	0.14	300
ILC0402ER2N2S	2.2	0.3 nH	100	8	10	23	32	6000	8700	0.16	300
ILC0402ER2N7S	2.7	0.3 nH	100	8	10	21	30	6000	7800	0.17	300
ILC0402ER3N3S	3.3	0.3 nH	100	8	10	22	31	6000	6400	0.19	300
ILC0402ER3N9S	3.9	0.3 nH	100	8	10	19	26	4000	5800	0.22	300
ILC0402ER4N7S	4.7	0.3 nH	100	8	10	19	26	4000	5100	0.24	300
ILC0402ER5N6S	5.6	0.3 nH	100	8	10	20	26	4000	4700	0.27	300
ILC0402ER6N8J	6.8	5 %	100	8	10	19	26	3900	4200	0.32	250
ILC0402ER8N2J	8.2	5 %	100	8	10	22	29	3600	3800	0.37	250
ILC0402ER10NJ	10	5 %	100	8	10	18	23	3200	3400	0.42	250
ILC0402ER12NJ	12	5 %	100	8	10	18	23	2700	2900	0.50	250
ILC0402ER15NJ	15	5 %	100	8	10	19	24	2300	2500	0.55	250
ILC0402ER18NJ	18	5 %	100	8	10	20	25	2100	2400	0.65	200
ILC0402ER22NJ	22	5 %	100	8	10	22	26	1900	2200	0.80	200
ILC0402ER27NJ	27	5 %	100	8	10	22	25	1600	2000	0.90	200
ILC0402ER33NJ	33	5 %	100	8	10	19	20	1300	1800	1.00	200
ILC0402ER39NJ	39	5 %	100	8	10	21	20	1200	1600	1.20	150
ILC0402ER47NJ	47	5 %	100	8	10	18	15	1000	1500	1.30	150
ILC0402ER56NJ	56	5 %	100	8	11	21	14	750	1200	1.40	150
ILC0402ER68NJ	68	5 %	100	8	11	18	12	750	1250	1.40	150
ILC0402ER82NJ	82	5 %	100	8	11	19	8	600	1100	2.00	100
ILC0402ERR10J	100	5 %	100	8	11	17	2	600	1000	2.00	100

DIMENSIONS in inches [millimeters]

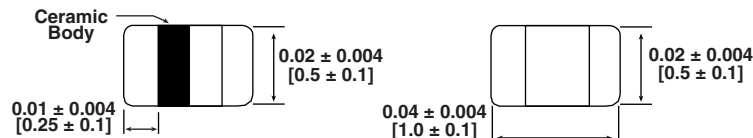

DESCRIPTION

ILC-0402	10 nH	± 10 %	ER	e3
MODEL	INDUCTANCE VALUE	INDUCTANCE TOLERANCE	PACKAGE CODE	JEDEC LEAD (Pb)-FREE STANDARD

GLOBAL PART NUMBER

I	L	C	0	4	0	2	E	R	1	0	N	K
PRODUCT FAMILY			SIZE				PACKAGE CODE		INDUCTANCE VALUE			TOL.

Surface Mount, Multi Layer High Frequency Ceramic Inductors



MECHANICAL SPECIFICATIONS

Solderability: 90 % coverage after 5 s dip in 235 °C solder following 60 s preheat at 120 °C and type R flux dip

Resistance to Solder Heat: 10 s in 260 °C solder, after preheat and flux above

Terminal Strength: 0.3 kg (0.66 lbs) for 30 s

Beam Strength: 0.3 kg (0.66 lbs)

Flex: 0.0788" [2.0 mm] min. mounted on 0.063" [1.6 mm] thick PC board

FEATURES

- High reliability
- Surface mountable
- Reflow or wave solderable
- Tape and reel packaging per EIA specifications: 4000 pieces on 7" reel
- Compliant to RoHS Directive 2002/95/EC
- Halogen-free according to IEC 61249-2-21 definition



RoHS
COMPLIANT
HALOGEN
FREE

ENVIRONMENTAL SPECIFICATIONS

Operating Temperature: - 55 °C to + 125 °C

Thermal Shock: 100 cycles, - 40 °C to + 85 °C

Humidity: + 40 °C, 85 % RH, 1000 h at full rated current

Load Life: 85 °C for 1000 h at full rated current

STANDARD ELECTRICAL SPECIFICATIONS

PART NUMBER	IND. (nH)	TOL.	TEST FREQUENCY (MHz)	Q MIN.	Q TYPICAL			SRF (MHz)		DCR MAX. (Ω)	RATED DC CURRENT MAX. (mA)
					100 MHz	500 MHz	1000 MHz	MIN.	TYP.		
ILC0603ER1N0S	1.0	0.3 nH	100	8	15	43	63	10 000	15 000	0.05	300
ILC0603ER1N2S	1.2	0.3 nH	100	8	14	38	55	10 000	14 000	0.05	300
ILC0603ER1N5S	1.5	0.3 nH	100	8	11	28	40	6000	13 000	0.10	300
ILC0603ER1N8S	1.8	0.3 nH	100	8	10	24	35	6000	11 000	0.10	300
ILC0603ER2N2S	2.2	0.3 nH	100	8	14	35	40	6000	10 000	0.10	300
ILC0603ER2N7S	2.7	0.3 nH	100	10	12	29	45	6000	7000	0.10	300
ILC0603ER3N3S	3.3	0.3 nH	100	10	16	40	47	4000	5900	0.12	300
ILC0603ER3N9S	3.9	0.3 nH	100	10	11	25	35	3500	4500	0.14	300
ILC0603ER4N7S	4.7	0.3 nH	100	10	11	26	35	3500	4500	0.16	300
ILC0603ER5N6S	5.6	0.3 nH	100	10	15	36	46	3500	4000	0.18	300
ILC0603ER6N8J	6.8	5 %	100	10	15	38	47	3000	3600	0.22	300
ILC0603ER8N2J	8.2	5 %	100	10	13	31	41	3000	3500	0.24	300
ILC0603ER10NJ	10	5 %	100	12	15	34	47	2800	3000	0.26	300
ILC0603ER12NJ	12	5 %	100	12	12	27	49	2000	2500	0.28	300
ILC0603ER15NJ	15	5 %	100	12	15	30	36	2000	2200	0.32	300
ILC0603ER18NJ	18	5 %	100	12	15	28	31	1800	2000	0.35	300
ILC0603ER22NJ	22	5 %	100	12	17	34	36	1800	1900	0.40	300
ILC0603ER27NJ	27	5 %	100	12	15	31	30	1500	1700	0.45	300
ILC0603ER33NJ	33	5 %	100	12	15	28	24	1200	1500	0.55	300
ILC0603ER39NJ	39	5 %	100	12	14	31	28	1100	1300	0.60	300
ILC0603ER47NJ	47	5 %	100	12	17	31	28	900	1300	0.70	300
ILC0603ER56NJ	56	5 %	100	12	19	34	26	900	1200	0.75	300
ILC0603ER68NJ	68	5 %	100	12	17	30	20	700	1000	0.85	300
ILC0603ER82NJ	82	5 %	100	12	16	29	18	600	1000	0.95	300
ILC0603ERR10J	100	5 %	100	12	16	24	3	600	800	1.00	300
ILC0603ERR12J	120	5 %	50	8	17	21	-	500	800	1.20	300
ILC0603ERR15J	150	5 %	50	8	19	20	-	500	700	1.20	300
ILC0603ERR18J	180	5 %	50	8	18	13	-	400	600	1.30	300
ILC0603ERR22J	220	5 %	50	8	18	-	-	400	500	1.50	300
ILC0603ERR27J	270	5 %	50	8	19	-	-	350	490	1.60	300

DIMENSIONS in inches [millimeters]

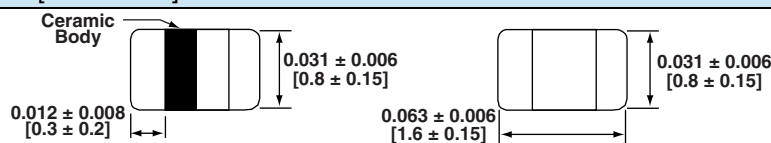

DESCRIPTION

ILC-0603	10 nH	± 10 %	ER	e3
MODEL	INDUCTANCE VALUE	INDUCTANCE TOLERANCE	PACKAGE CODE	JEDEC LEAD (Pb)-FREE STANDARD

GLOBAL PART NUMBER

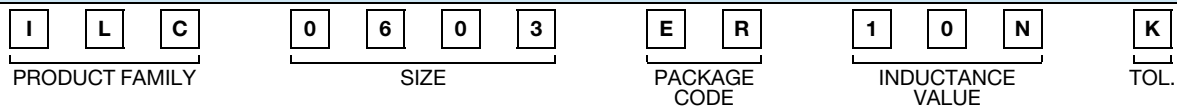

Surface Mount, Multilayer High Frequency Ceramic Inductors



MECHANICAL SPECIFICATIONS

Solderability: 90 % coverage after 5 s dip in 235 °C solder following 60 s preheat at 120 °C and type R flux dip

Resistance to Solder Heat: 10 s in 260 °C solder, after preheat and flux above

Terminal Strength: 0.6 kg (1.32 lbs) for 30 s

Termination: 100 % tin

Beam Strength: 1.0 kg (2.20 lbs)

Flex: 0.0788" [2.0 mm] min. mounted on 0.063" [1.6 mm] thick PC board

FEATURES

- High reliability
- Surface mountable
- Reflow or wave solderable
- Tape and reel packaging per EIA specifications: 4000 pieces on 7" reel
- Compliant to RoHS Directive 2002/95/EC
- Halogen-free according to IEC 61249-2-21 definition



RoHS
COMPLIANT
HALOGEN
FREE

ENVIRONMENTAL SPECIFICATIONS

Operating Temperature: - 55 °C to + 125 °C

Thermal Shock: 100 cycles, - 40 °C to + 85 °C

Humidity: + 40 °C, 85 % RH, 1000 h at full rated current

Load Life: 85 °C for 1000 h at full rated current

STANDARD ELECTRICAL SPECIFICATIONS

PART NUMBER	IND. (nH)	TOL.	THICKNESS "D" (INCHES [mm])	TEST FREQ. (MHz)	Q MIN.	Q TYPICAL			SRF (MHz)		DCR MAX. (Ω)	RATED DC CURRENT MAX. (mA)
						100 MHz	500 MHz	1000 MHz	MIN.	TYP.		
ILC0805ER1N5S	1.5	0.3 nH	0.035 ± 0.008 [0.90 ± 0.2]	100	10	16	43	67	4000	7000	0.10	300
ILC0805ER1N8S	1.8	0.3 nH	0.035 ± 0.008 [0.90 ± 0.2]	100	10	16	56	59	4000	7000	0.10	300
ILC0805ER2N2S	2.2	0.3 nH	0.035 ± 0.008 [0.90 ± 0.2]	100	10	16	40	58	4000	7000	0.10	300
ILC0805ER2N7S	2.7	0.3 nH	0.035 ± 0.008 [0.90 ± 0.2]	100	12	16	43	60	4000	6500	0.10	300
ILC0805ER3N3S	3.3	0.3 nH	0.035 ± 0.008 [0.90 ± 0.2]	100	12	19	52	70	4000	5500	0.13	300
ILC0805ER3N9S	3.9	0.3 nH	0.035 ± 0.008 [0.90 ± 0.2]	100	12	19	52	75	3000	4400	0.15	300
ILC0805ER4N7S	4.7	0.3 nH	0.035 ± 0.008 [0.90 ± 0.2]	100	12	19	53	70	3000	3500	0.20	300
ILC0805ER5N6S	5.6	0.3 nH	0.035 ± 0.008 [0.90 ± 0.2]	100	15	19	53	70	3000	3500	0.23	300
ILC0805ER6N8J	6.8	5 %	0.035 ± 0.008 [0.90 ± 0.2]	100	15	19	44	60	2500	3300	0.25	300
ILC0805ER8N2J	8.2	5 %	0.035 ± 0.008 [0.90 ± 0.2]	100	15	19	45	60	2000	2600	0.28	300
ILC0805ER10NJ	10	5 %	0.035 ± 0.008 [0.90 ± 0.2]	100	15	20	53	60	3000	2300	0.30	300
ILC0805ER12NJ	12	5 %	0.035 ± 0.008 [0.90 ± 0.2]	100	15	20	36	45	1500	2000	0.35	300
ILC0805ER15NJ	15	5 %	0.035 ± 0.008 [0.90 ± 0.2]	100	15	20	46	45	1500	1800	0.40	300
ILC0805ER18NJ	18	5 %	0.035 ± 0.008 [0.90 ± 0.2]	100	15	20	52	45	1300	1700	0.45	300
ILC0805ER22NJ	22	5 %	0.035 ± 0.008 [0.90 ± 0.2]	100	18	20	40	31	1200	1400	0.50	300
ILC0805ER27NJ	27	5 %	0.035 ± 0.008 [0.90 ± 0.2]	100	18	20	44	29	1000	1300	0.55	300
ILC0805ER33NJ	33	5 %	0.035 ± 0.008 [0.90 ± 0.2]	100	18	20	36	15	1000	1200	0.60	300
ILC0805ER39NJ	39	5 %	0.035 ± 0.008 [0.90 ± 0.2]	100	18	20	36	12	800	1100	0.65	300
ILC0805ER47NJ	47	5 %	0.035 ± 0.008 [0.90 ± 0.2]	100	18	21	33	12	800	1000	0.70	300
ILC0805ER56NJ	56	5 %	0.035 ± 0.008 [0.90 ± 0.2]	100	18	21	31	9	700	900	0.75	300
ILC0805ER68NJ	68	5 %	0.035 ± 0.008 [0.90 ± 0.2]	100	18	21	30	-	600	800	0.80	300
ILC0805ER82NJ	82	5 %	0.035 ± 0.008 [0.90 ± 0.2]	100	18	22	26	-	500	700	0.90	300
ILC0805ERR10J	100	5 %	0.035 ± 0.008 [0.90 ± 0.2]	100	18	22	22	-	500	700	0.90	300
ILC0805ERR12J	120	5 %	0.035 ± 0.008 [0.90 ± 0.2]	50	13	22	17	-	400	600	0.95	300
ILC0805ERR15J	150	5 %	0.035 ± 0.008 [0.90 ± 0.2]	50	13	22	9	-	300	600	1.00	300
ILC0805ERR18J	180	5 %	0.035 ± 0.008 [0.90 ± 0.2]	50	13	21	8	-	300	500	1.10	300
ILC0805ERR22J	220	5 %	0.035 ± 0.008 [0.90 ± 0.2]	50	12	20	4	-	300	500	1.20	300
ILC0805ERR27J	270	5 %	0.035 ± 0.008 [0.90 ± 0.2]	50	12	24	17	-	200	400	1.30	300

DIMENSIONS in inches [millimeters]

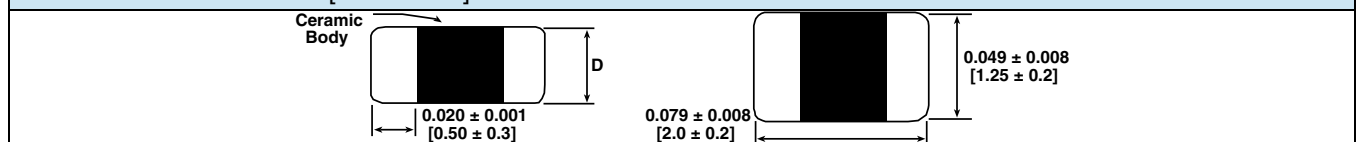

DESCRIPTION

ILC-0805	10 nH	± 10 %	ER	e3
MODEL	INDUCTANCE VALUE	INDUCTANCE TOLERANCE	PACKAGE CODE	JEDEC LEAD (Pb)-FREE STANDARD

GLOBAL PART NUMBER

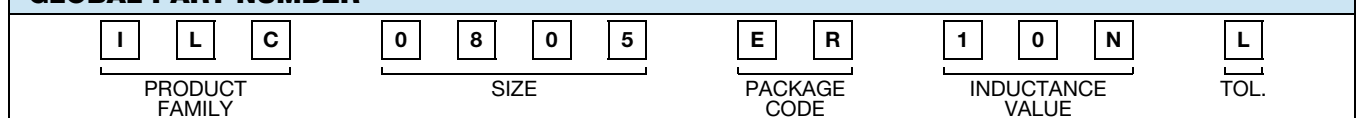

High Frequency, Surface Mount, Laser Spiral, Coated Inductors

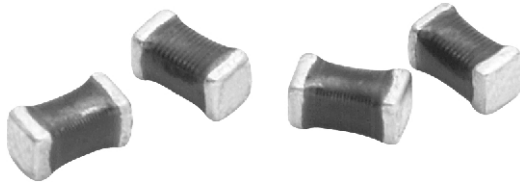
FEATURES

- Very small size
- High self-resonant frequency values
- High Q values relative to size at higher frequencies
- Coated coil provides protection and moisture resistance
- Compatible with vapor phase and infrared reflow soldering
- Tape and reel packaging for automatic handling, 10 000/reel, EIA-481
- L and Q value not affected by mounting orientation
- Compliant to RoHS Directive 2002/95/EC
- Halogen-free according to IEC 61249-2-21 definition

RoHS
 COMPLIANT
 HALOGEN
FREE

STANDARD ELECTRICAL SPECIFICATIONS							
IND. (nH)	TOL.	TEST FREQ. (MHz)		Q MIN.	SRF MIN. (MHz)	DCR MAX. (Ω)	RATED DC CURRENT (mA) ⁽¹⁾
		L	Q				
1.0	0.3 nH, 0.2 nH	100	800	21	6000	0.05	400
1.2	0.3 nH, 0.2 nH	100	800	21	6000	0.06	400
1.5	0.3 nH, 0.2 nH	100	800	21	6000	0.07	400
1.8	0.3 nH, 0.2 nH	100	800	21	6000	0.08	400
2.2	0.3 nH, 0.2 nH	100	800	21	6000	0.09	400
2.7	0.3 nH, 0.2 nH	100	800	21	5500	0.10	400
3.3	0.3 nH, 0.2 nH	100	800	21	5500	0.12	400
3.9	0.3 nH, 0.2 nH	100	800	20	5200	0.15	360
4.7	0.3 nH, 0.2 nH	100	800	20	4800	0.17	360
5.6	0.3 nH, 0.2 nH	100	800	20	4600	0.19	340
6.8	5 %	100	800	19	4000	0.30	320
8.2	5 %	100	800	19	3500	0.35	320
10	5 %, 2 %	100	800	19	2800	0.41	320
12	5 %, 2 %	100	800	19	2800	0.45	320
15	5 %, 2 %	100	800	19	2500	0.60	240
18	5 %, 2 %	100	800	19	2200	0.70	240
22	5 %, 2 %	100	800	19	2000	0.80	200
27	5 %, 2 %	100	800	19	1800	1.20	200
33	5 %, 2 %	100	800	18	1800	1.40	170
39	5 %, 2 %	100	800	18	1800	1.70	150
47	5 %, 2 %	100	800	17	1800	2.10	140
56	5 %, 2 %	100	800	17	1500	2.50	130
68	5 %, 2 %	100	800	15	1500	4.00	120
82	5 %, 2 %	100	800	15	1400	4.50	110
100	5 %, 2 %	100	800	14	1200	5.50	90

Note

(1) Value obtained when current flows and temperature has risen 15 °C

ELECTRICAL SPECIFICATIONS
Inductance Range: 1.0 nH to 100 nH

Inductance and Tolerance: ± 0.3 nH for 1.0 nH to 5.6 nH, ± 5 % for 6.8 nH to 100 nH

Operating Temperature: - 40 °C to + 100 °C

Core Material: Ceramic

TEST EQUIPMENT

- Inductance and Q measured on HP4291B
- SRF measured on HP8753E
- DCR measured on HP4338B

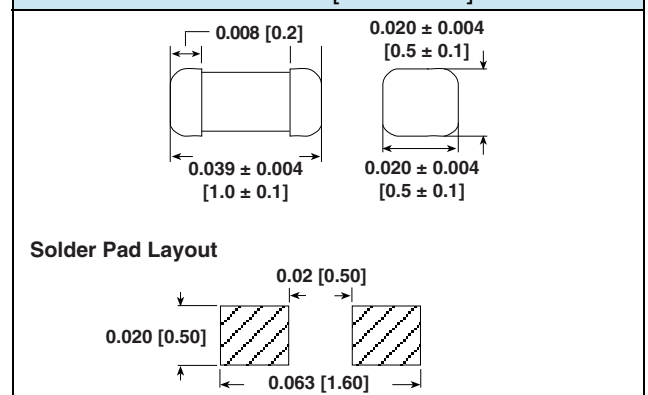
DIMENSIONS in inches [millimeters]

DESCRIPTION

IMC-0402	10 nH	± 5 %	ER	e3
MODEL	INDUCTANCE VALUE	INDUCTANCE TOLERANCE	PACKAGE CODE	JEDEC LEAD (Pb)-FREE STANDARD

GLOBAL PART NUMBER

I	M	C	0	4	0	2	E	R	1	0	N	J
PRODUCT FAMILY			SIZE			PACKAGE CODE		INDUCTANCE VALUE			TOL.	

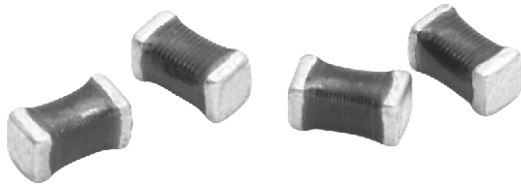
High Frequency, Surface Mount, Laser Spiral, Coated Inductors



FEATURES

- Very small size
- High self-resonant frequency values
- High Q values relative to size at higher frequencies
- Coated coil provides protection and moisture resistance
- Compatible with vapor phase and infrared reflow soldering
- Tape and reel packaging for automatic handling, 3000/reel, EIA-481
- L and Q value not affected by mounting orientation
- Compliant to RoHS Directive 2002/95/EC
- Halogen-free according to IEC 61249-2-21 definition



RoHS
COMPLIANT
HALOGEN
FREE

STANDARD ELECTRICAL SPECIFICATIONS							
IND. (nH)	TOL.	TEST FREQ. (MHz)		Q MIN.	SRF MIN. (MHz)	DCR MAX. (Ω)	RATED DC CURRENT (mA) ⁽¹⁾
		L	Q				
1.0	0.3 nH, 0.2 nH	100	1000	30	6000	0.06	500
1.2	0.3 nH, 0.2 nH	100	1000	30	6000	0.06	500
1.5	0.3 nH, 0.2 nH	100	1000	30	6000	0.07	500
1.8	0.3 nH, 0.2 nH	100	1000	30	6000	0.08	500
2.2	0.3 nH, 0.2 nH	100	1000	30	6000	0.09	500
2.7	0.3 nH, 0.2 nH	100	1000	30	6000	0.10	500
3.3	0.3 nH, 0.2 nH	100	1000	30	5500	0.12	500
3.9	5 %	100	1000	30	5500	0.15	450
4.7	5 %	100	1000	30	4800	0.17	450
5.6	5 %	100	1000	30	4600	0.19	430
6.8	5 %	100	1000	30	3550	0.20	430
8.2	5 %	100	1000	30	3500	0.28	400
10	5 %, 2 %	100	500	30	2800	0.32	400
12	5 %, 2 %	100	500	30	2800	0.35	400
15	5 %, 2 %	100	500	30	2500	0.41	350
18	5 %, 2 %	100	500	30	2300	0.45	350
22	5 %, 2 %	100	500	30	2000	0.50	300
27	5 %, 2 %	100	500	30	2000	0.55	300
33	5 %, 2 %	100	500	30	1800	0.60	300
39	5 %, 2 %	100	500	30	1800	0.80	300
47	5 %, 2 %	100	500	30	1800	0.95	250
56	5 %, 2 %	100	500	30	1800	1.20	250
68	5 %, 2 %	100	500	30	1500	1.30	250
82	5 %, 2 %	100	500	30	1500	1.50	250
100	5 %, 2 %	100	500	26	1300	1.80	200
120	5 %, 2 %	100	500	26	1200	3.00	130
150	5 %, 2 %	100	500	26	1100	4.50	100
180	5 %, 2 %	100	500	20	1000	6.50	80
220	5 %, 2 %	100	500	20	900	7.50	70

Note

⁽¹⁾ Value obtained when current flows and temperature has risen 15 °C

ELECTRICAL SPECIFICATIONS

Inductance Range: 1.0 nH to 220 nH

Inductance and Tolerance: ± 0.3 nH for 1.0 nH to 3.3 nH,
± 5 % for 3.9 nH to 220 nH

Operating Temperature: - 40 °C to + 100 °C

Core Material: Ceramic

TEST EQUIPMENT

- Inductance and Q measured on HP4291B
- SRF measured on HP8753E
- DCR measured on HP4338B

DIMENSIONS in inches [millimeters]

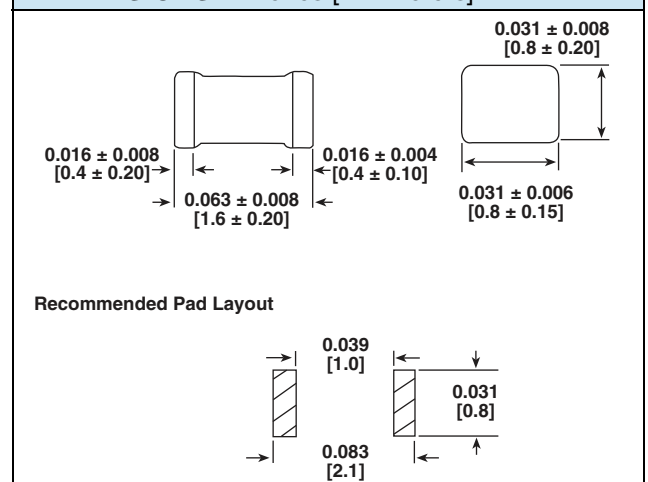

DESCRIPTION

IMC-0603	10 nH	± 5 %	ER	e3
MODEL	INDUCTANCE VALUE	INDUCTANCE TOLERANCE	PACKAGE CODE	JEDEC LEAD (Pb)-FREE STANDARD

GLOBAL PART NUMBER

I	M	C	0	6	0	3	E	R	1	0	N	J
PRODUCT FAMILY			SIZE			PACKAGE CODE		INDUCTANCE VALUE			TOL.	



Wirewound Inductors

Contents

IMC-0402-01	175
IMC-0603-01	177
IMC-0805	179
IMC-0805-01	180
IMC-1008	182
ISC-1008	184
IMC-1210	186
IMC-1210-100	187
ISC-1210	188
IMC-1812	189
ISC-1812	191
IMCH-1812	193
IMC-2220	194

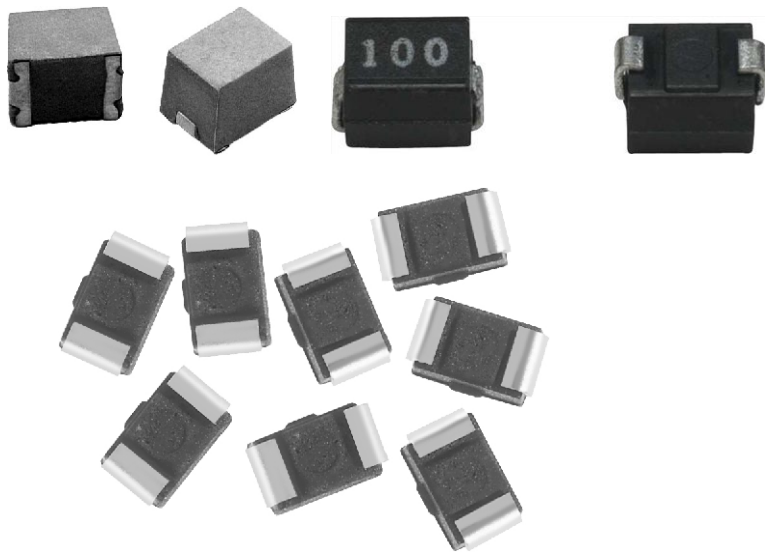

Wirewound, Surface Mount Inductors



STANDARD ELECTRICAL SPECIFICATIONS						
IND. (nH)	TOL.	TEST FREQ. (MHz)	Q	SRF MIN. (MHz)	DCR MAX. (Ω)	RATED DC CURRENT (mA) ⁽¹⁾
		L & Q	MIN.			
1.0	0.3 nH, 0.2 nH	250	13	6000	0.045	1360
1.9	0.3 nH, 0.2 nH	250	16	6000	0.070	1040
2.0	0.3 nH, 0.2 nH	250	16	6000	0.070	1040
2.2	0.3 nH, 0.2 nH	250	18	6000	0.070	960
2.4	0.3 nH, 0.2 nH	250	16	6000	0.068	790
2.7	0.3 nH, 0.2 nH	250	16	6000	0.120	640
3.3	0.3 nH, 0.2 nH	250	20	6000	0.066	840
3.6	0.3 nH, 0.2 nH	250	20	6000	0.066	840
3.9	10 %, 5 %	250	20	6000	0.066	840
4.3	10 %, 5 %	250	18	6000	0.091	700
4.7	10 %, 5 %	250	15	4775	0.130	640
5.1	10 %, 5 %	250	23	5800	0.083	800
5.6	10 %, 5 %	250	23	5800	0.083	760
6.2	10 %, 5 %	250	23	5800	0.083	760
6.8	10 %, 5 %	250	20	4800	0.083	680
7.5	10 %, 5 %	250	25	5800	0.104	680
8.2	10 %, 5 %	250	25	4400	0.104	680
8.7	10 %, 5 %	250	18	4100	0.200	480
9.0	10 %, 5 %	250	25	4160	0.104	680
9.5	10 %, 5 %	250	18	4000	0.200	680
10	5 %, 2 %	250	23	3900	0.195	480
11	5 %, 2 %	250	26	3680	0.120	640
12	5 %, 2 %	250	26	3600	0.120	640
13	5 %, 2 %	250	24	3450	0.210	560
15	5 %, 2 %	250	26	3280	0.172	560
16	5 %, 2 %	250	24	3100	0.220	560
18	5 %, 2 %	250	25	3100	0.230	420
19	5 %, 2 %	250	26	3040	0.202	480
20	5 %, 2 %	250	25	3000	0.250	420
22	5 %, 2 %	250	25	2800	0.300	400
23	5 %, 2 %	250	26	2720	0.214	400
24	5 %, 2 %	250	25	2480	0.298	400
27	5 %, 2 %	250	26	2700	0.300	400
30	5 %, 2 %	250	25	2350	0.300	400
33	5 %, 2 %	250	24	2350	0.350	400
36	5 %, 2 %	250	26	2320	0.403	320
39	5 %, 2 %	250	25	2100	0.550	320
40	5 %, 2 %	250	26	2240	0.438	320
43	5 %, 2 %	250	25	2030	0.810	100
47	5 %, 2 %	200	26	2100	0.830	150
51	5 %	200	25	1750	0.820	100
56	5 %	200	22	1760	0.970	100
68	5 %	200	22	1620	1.120	100
82	5 %	150	20	1500	1.250	100
100	5 %	150	20	1300	2.520	100
120	5 %	150	20	1100	2.660	100

Note
⁽¹⁾ Value obtained when current flows and temperature has risen 15 °C

FEATURES

- Excellent solderability and resistance to soldering heat
- Suitable for reflow soldering
- High reliability and easy surface mount assembly
- Wide range of inductance values available
- Tape and reel packaging for automatic handling, 10 000/reel EIA 481
- Compliant to RoHS Directive 2002/95/EC
- Halogen-free according to IEC 61249-2-21 definition



RoHS
 COMPLIANT
 HALOGEN
FREE
ELECTRICAL SPECIFICATIONS
Inductance Range: 1 nH to 47 nH

Operating Temperature: - 40 °C to + 125 °C

Storage Temperature: - 40 °C to + 125 °C

TEST EQUIPMENT

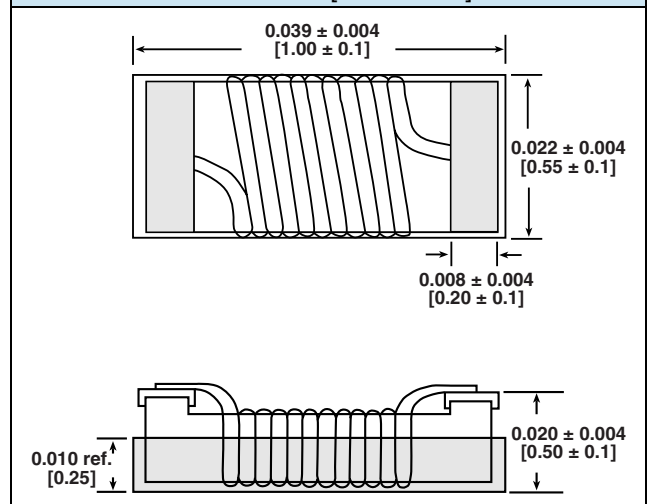
- Inductance is measured in HP4287A RF LCR meter with HP16193 fixture
- Q is measured in HP4287A RF LCR meter with HP16193 fixture
- SRF is measured in HP8753E RF network analyzer
- DCR is measured in HP4338B milliohmmeter

DIMENSIONS in inches [millimeters]

DESCRIPTION

IMC-0402-01	10 nH	± 5 %	ER	e4
MODEL	INDUCTANCE VALUE	INDUCTANCE TOLERANCE	PACKAGE CODE	JEDEC LEAD (Pb)-FREE STANDARD

GLOBAL PART NUMBER

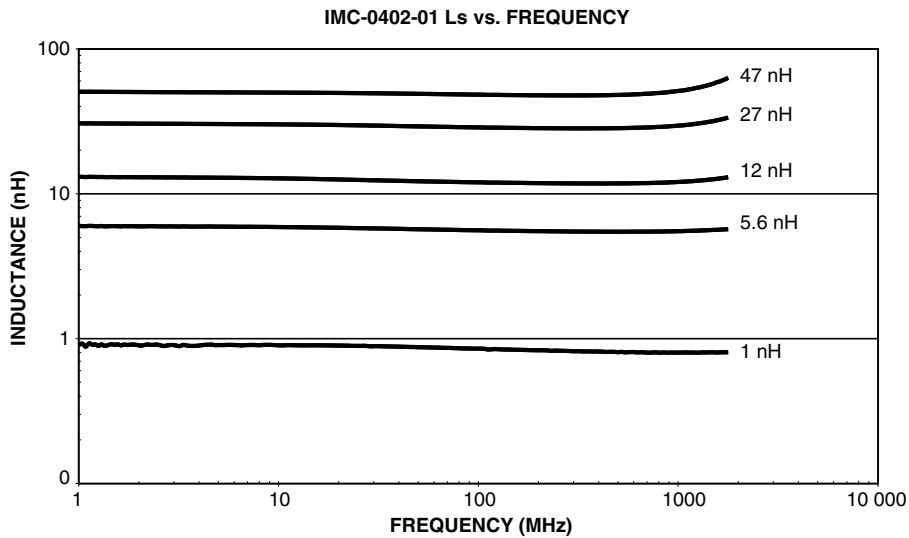
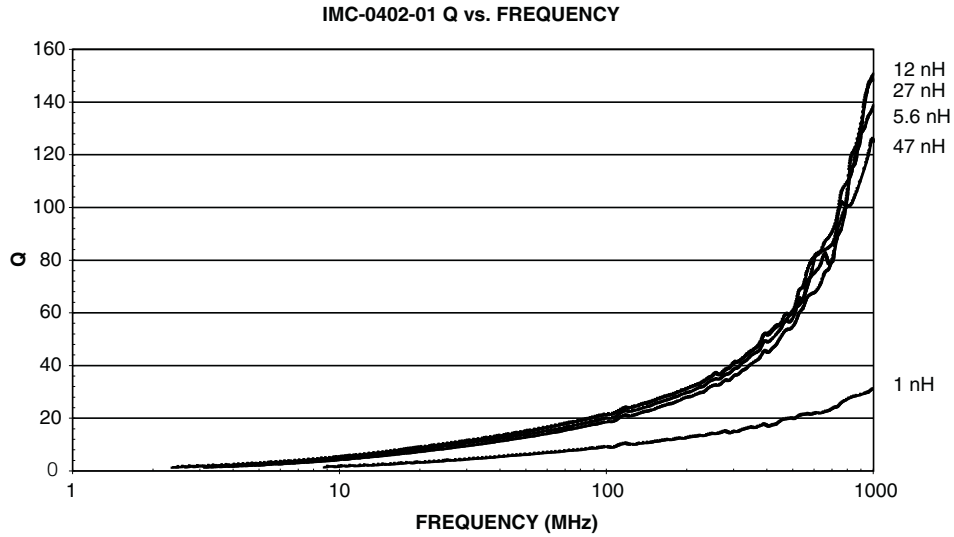
I	M	C	0	4	0	2	E	R	1	0	N	J	0	1
PRODUCT FAMILY			SIZE				PACKAGE CODE		INDUCTANCE VALUE			TOL.	SERIES	

PERFORMANCE GRAPHS (IMC-0402-01)

TAPE AND REEL SPECIFICATIONS in inches [millimeters]

REEL DIMENSIONS		TAPE DIMENSIONS				RECOMMENDED PATTERN			
MODEL	UNITS PER REEL	MODEL	A	B	T	MODEL	A	B	C
IMC-0402-01	10 000	IMC-0402-01	0.028 [0.70]	0.047 [1.20]	0.028 [0.70]	IMC-0402-01	0.018 [0.45]	0.063 [1.60]	0.0256 [0.65]

Wirewound, Surface Mount Inductors



FEATURES

- Excellent solderability and resistance to soldering heat
- Suitable for reflow soldering
- High reliability and easy surface mount assembly
- Wide range of inductance values available
- Tape and reel packaging for automatic handling, 3000/reel EIA 481
- Compliant to RoHS Directive 2002/95/EC

RoHS
COMPLIANT

GREEN
(5-2008)**

STANDARD ELECTRICAL SPECIFICATIONS						
IND. (nH)	TOL.	TEST FREQ. (MHz)	Q MIN.	SRF MIN. (MHz)	DCR MAX. (Ω)	RATED DC CURRENT (mA) ⁽¹⁾
		L & Q				
2.0	0.3 nH, 0.2 nH	250	16	6900	0.08	700
3.9	0.3 nH, 0.2 nH	250	20	6900	0.08	700
4.7	0.3 nH, 0.2 nH	250	20	5800	0.11	700
6.8	10 %, 5 %	250	30	5800	0.11	700
8.2	10 %, 5 %	250	30	4600	0.10	700
10	5 %, 2 %	250	30	4800	0.13	700
12	5 %, 2 %	250	35	4000	0.13	700
15	5 %, 2 %	250	35	4000	0.17	700
18	5 %, 2 %	250	38	3100	0.17	700
22	5 %, 2 %	250	38	3000	0.22	700
27	5 %, 2 %	250	40	2800	0.22	600
33	5 %, 2 %	250	43	2300	0.22	600
39	5 %, 2 %	250	43	2200	0.25	600
47	5 %, 2 %	200	40	2000	0.28	600
56	5 %, 2 %	200	40	1900	0.31	600
68	5 %, 2 %	200	40	1700	0.34	600
72	5 %, 2 %	150	35	1700	0.49	400
82	5 %, 2 %	150	35	1700	0.54	400
100	5 %, 2 %	150	35	1400	0.63	400
120	5 %, 2 %	150	35	1300	0.65	300
150	5 %, 2 %	150	35	1000	0.92	280
180	5 %, 2 %	100	30	1000	1.25	240
220	5 %, 2 %	100	30	1000	1.70	200
270	5 %, 2 %	100	30	1000	1.80	170

Note

(1) Value obtained when current flows and temperature has risen 15 °C

ELECTRICAL SPECIFICATIONS

Inductance Range: 2 nH to 270 nH

Operating Temperature: - 40 °C to + 125 °C

Storage Temperature: - 40 °C to + 125 °C

TEST EQUIPMENT

- Inductance is measured in HP4287A RF LCR meter with HP16193 fixture
- Q is measured in HP4287A RF LCR meter with HP16193 fixture
- SRF is measured in HP8753E RF network analyzer
- DCR is measured in HP4338B milliohmmeter

DIMENSIONS in inches [millimeters]

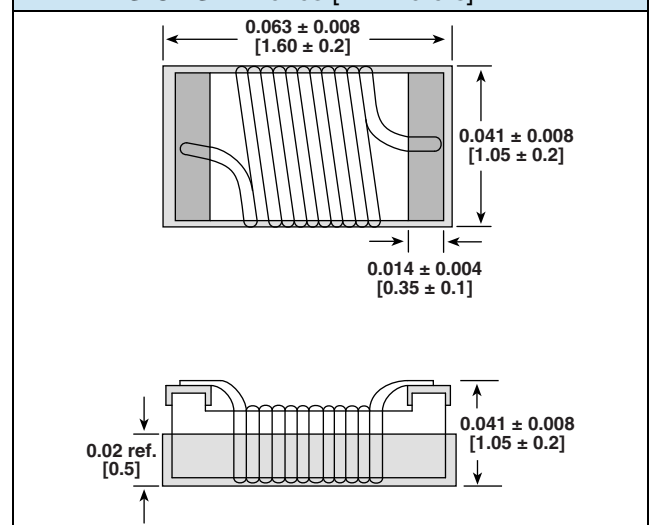

DESCRIPTION				
IMC-0603-01	10 nH	± 5 %	ER	e4
MODEL	INDUCTANCE VALUE	INDUCTANCE TOLERANCE	PACKAGE CODE	JEDEC LEAD (Pb)-FREE STANDARD

GLOBAL PART NUMBER														
I	M	C	0	6	0	3	E	R	1	0	N	J	0	1
PRODUCT FAMILY			SIZE			PACKAGE CODE		INDUCTANCE VALUE			TOL.	SERIES		

 ** Please see document "Vishay Material Category Policy": www.vishay.com/doc?99902

PERFORMANCE GRAPHS (IMC-0603-01)

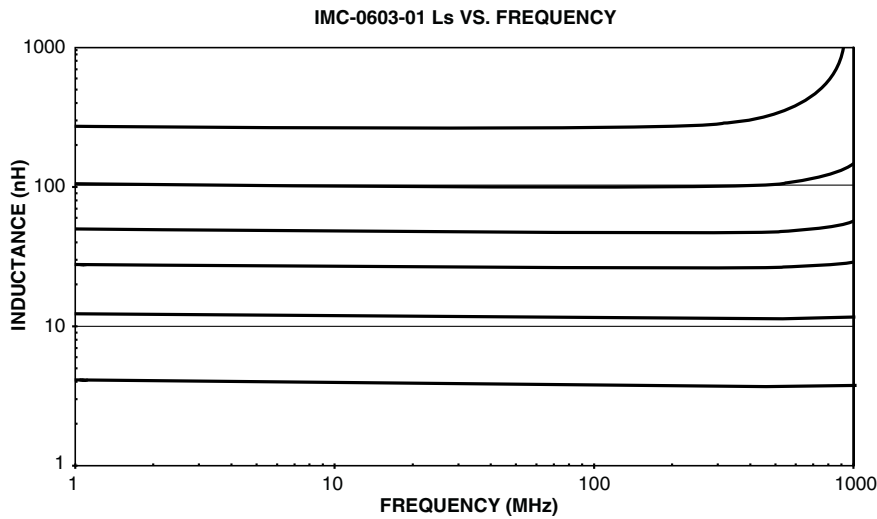
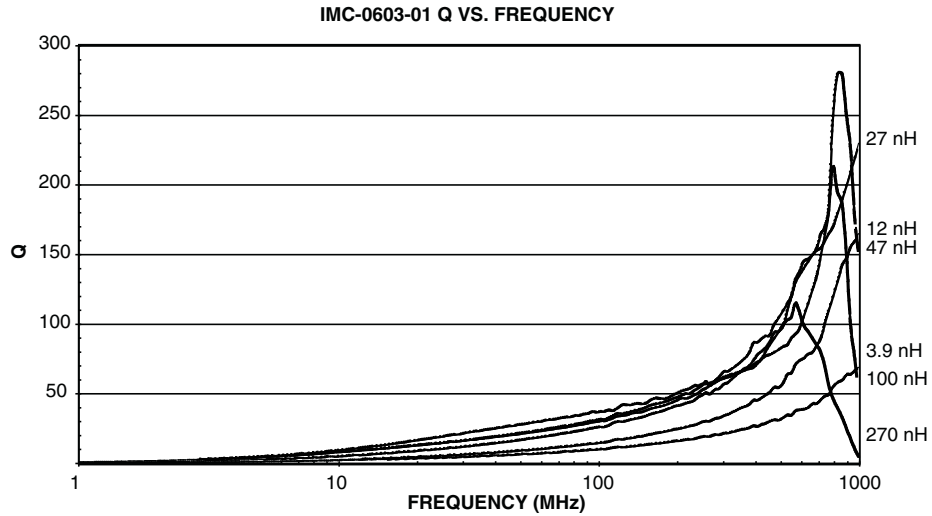

TAPE AND REEL SPECIFICATIONS in inches [millimeters]

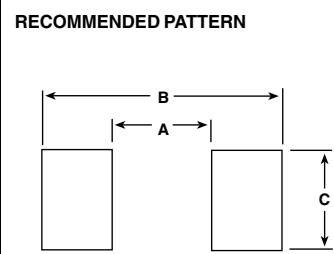
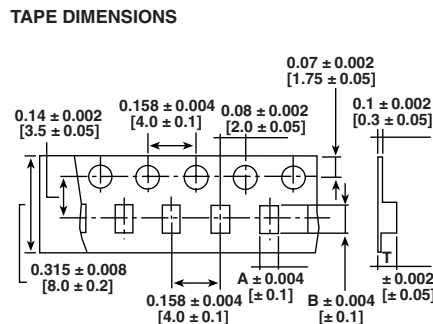
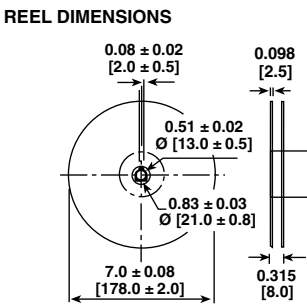

MODEL	UNITS PER REEL	MODEL	A	B	T	MODEL	A	B	C
IMC-0603-01	3000	IMC-0603-01	0.039 [1.0]	0.070 [1.8]	0.039 [1.0]	IMC-0603-01	0.039 [1.0]	0.083 [2.1]	0.030 [0.8]

High Frequency, Surface Mount, Molded Inductors

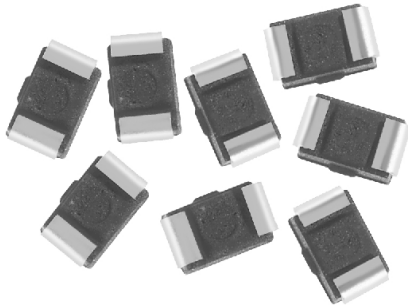

FEATURES

- High self-resonant frequency values
- High Q values at higher frequencies
- Molded construction provides superior strength and moisture resistance
- Wirewound construction
- Compatible with vapor phase and infrared reflow soldering
- Tape and reel packaging for automatic handling, 3000/reel, EIA-481
- Compliant to RoHS Directive 2002/95/EC

RoHS
COMPLIANT

STANDARD ELECTRICAL SPECIFICATIONS									
IND. (nH)	TOL.	TEST FREQ. (MHz)	Q	Q TYP. (MHz)			SRF MIN. (MHz)	DCR ± 30 % (Ω)	RATED DC CURRENT (mA)
				L & Q	MIN.	100			
10	10 %	100	10	22	65	110	3300	0.14	540
12	10 %	100	10	22	65	105	3300	0.18	535
15	10 %	100	12	23	70	100	3000	0.18	520
18	10 %	100	12	25	75	95	3000	0.22	480
22	10 %	100	15	25	75	80	2600	0.22	465
27	10 %	100	15	25	75	-	2500	0.26	455
33	5 %, 10 %	100	15	28	80	-	2050	0.30	395
39	5 %, 10 %	100	15	28	70	-	2000	0.31	390
47	5 %, 10 %	100	15	28	70	-	1650	0.35	385
56	5 %, 10 %	100	15	28	60	-	1550	0.39	360
68	5 %, 10 %	100	15	28	-	-	1450	0.44	340
82	5 %, 10 %	100	15	28	-	-	1100	0.48	330
100	5 %, 10 %	25.2	8	25	-	-	800	0.66	285
120	5 %, 10 %	25.2	8	24	-	-	600	0.76	275
150	5 %, 10 %	25.2	10	25	-	-	600	1.13	230
180	5 %, 10 %	25.2	10	25	-	-	600	1.24	195
220	5 %, 10 %	25.2	10	25	-	-	500	1.41	170
270	5 %, 10 %	25.2	10	25	-	-	300	1.50	165
330	5 %, 10 %	25.2	10	20	-	-	200	1.66	160
390	5 %, 10 %	25.2	10	20	-	-	150	1.82	150
470	5 %, 10 %	25.2	10	18	-	-	150	1.97	145
560	5 %, 10 %	25.2	10	15	-	-	100	2.07	140
680	5 %, 10 %	25.2	10	-	-	-	100	2.32	130
820	5 %, 10 %	25.2	10	-	-	-	80	2.60	125
1000	5 %, 10 %	7.96	8	-	-	-	80	2.98	120

Note

- Tighter tolerance product may be substituted based on availability.

ELECTRICAL SPECIFICATIONS

Inductance Range: 10 nH to 1000 nH

Inductance and Tolerance: ± 10 % for 10 nH to 1000 nH, ± 5 % for 33 nH to 1000 nH

Operating Temperature: - 40 °C to + 105 °C (no load)
- 40 °C to + 85 °C (at full rated current)

Core Material: Non-magnetic

TEST EQUIPMENT

- Inductance and Q measured on HP4191A
- SRF measured on HP8753B

DIMENSIONS in inches [millimeters]

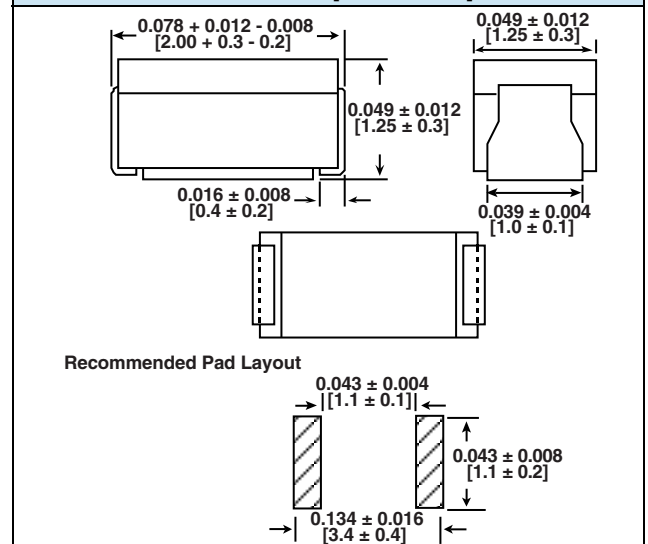

DESCRIPTION				
IMC-0805	10 nH	± 5 %	ER	e3
MODEL	INDUCTANCE VALUE	INDUCTANCE TOLERANCE	PACKAGE CODE	JEDEC LEAD (Pb)-FREE STANDARD

GLOBAL PART NUMBER				
I	M	C	0	8
PRODUCT FAMILY			SIZE	
E	R	1	0	N
PACKAGE CODE		INDUCTANCE VALUE		TOL.
				J

Wirewound, Surface Mount Inductors



STANDARD ELECTRICAL SPECIFICATIONS							
IND. (nH)	TOL.	TEST FREQ. (MHz)		Q MIN.	SRF MIN. (MHz)	DCR MAX. (Ω)	RATED DC CURRENT (mA)
		L	Q				
2.2	0.3 nH, 0.2 nH	250	1000	50	6000	0.06	800
2.7	0.3 nH, 0.2 nH	250	1000	35	6000	0.08	800
3.3	0.3 nH, 0.2 nH	250	1000	60	6000	0.08	800
3.9	0.3 nH, 0.2 nH	250	1000	60	6000	0.06	600
4.7	0.3 nH, 0.2 nH	250	1000	60	5800	0.06	600
5.6	5 %, 2 %	250	1000	60	5800	0.08	600
6.8	5 %, 2 %	250	1000	60	5500	0.06	600
8.2	5 %, 2 %	250	1000	60	5500	0.06	600
10	5 %, 2 %	250	500	60	4800	0.08	600
12	5 %, 2 %	250	500	60	4100	0.08	600
15	5 %, 2 %	250	500	60	3600	0.08	600
18	5 %, 2 %	250	500	60	3400	0.08	600
22	5 %, 2 %	250	500	60	3300	0.10	600
27	5 %, 2 %	250	500	60	2600	0.12	600
33	5 %, 2 %	250	500	60	2400	0.15	500
39	5 %, 2 %	250	500	60	2100	0.18	500
47	5 %, 2 %	200	500	60	1700	0.15	500
56	5 %, 2 %	200	500	60	1600	0.25	500
68	5 %, 2 %	200	500	60	1450	0.27	500
82	5 %, 2 %	150	500	60	1350	0.32	500
100	5 %, 2 %	150	500	60	1200	0.43	500
120	5 %, 2 %	150	250	50	1100	0.48	500
150	5 %, 2 %	100	250	50	950	0.56	400
180	5 %, 2 %	100	250	50	900	0.78	400
220	5 %, 2 %	100	250	50	860	1.00	400
270	5 %, 2 %	100	250	45	850	1.46	350
330	5 %, 2 %	100	250	45	800	1.65	300
390	5 %, 2 %	100	250	45	780	2.20	210
470	5 %	25.2	100	45	375	0.95	500
560	5 %	25.2	100	45	340	1.10	450
680	5 %	25.2	100	35	188	1.20	400
820	5 %	25.2	100	35	215	1.50	300
1000	5 %	25.2	50	35	200	2.13	180
1200	5 %	7.96	7.96	15	200	2.60	150
1500	5 %	7.96	7.96	15	200	2.90	130
1800	5 %	7.96	7.96	15	120	3.00	120
2200	5 %	7.96	7.96	15	110	3.10	110
2700	5 %	7.96	7.96	15	100	3.50	100
3300	5 %	7.96	7.96	15	70	2.30	210
3900	5 %	7.96	7.96	15	60	2.50	200
4700	5 %	7.96	7.96	15	50	2.80	180
5600	5 %	7.96	7.96	15	45	3.00	160
6800	5 %	7.96	7.96	15	45	3.20	130
8200	5 %	7.96	7.96	15	40	3.50	120
10 000	5 %	2.52	2.52	10	40	5.00	80

FEATURES

- High self-resonant frequency values
- High Q values at higher frequencies
- Wirewound construction
- Compatible with vapor phase and infrared reflow soldering
- Tape and reel packaging for automatic handling, 2000/reel
- Compliant to RoHS Directive 2002/95/EC
- Halogen-free according to IEC 61249-2-21 definition



RoHS
COMPLIANT
HALOGEN
FREE

ELECTRICAL SPECIFICATIONS

Inductance Range: 2.2 nH to 10 000 nH

Inductance and Tolerance: 0.3 nH for 2.2 nH to 4.7 nH, ± 5 % for 5.6 nH to 10 000 nH

Operating Temperature: - 40 °C to + 125 °C

Core Material: Ceramic from 2.2 nH to 390 nH; Ferrite from 470 nH to 10 000 nH

TEST EQUIPMENT

- Inductance and Q measured on HP4286A (2.2 nH to 390 nH) and HP4285A (470 nH to 10 000 nH)
- SRF is measured on HP8753E
- DCR is measured on HP4338B

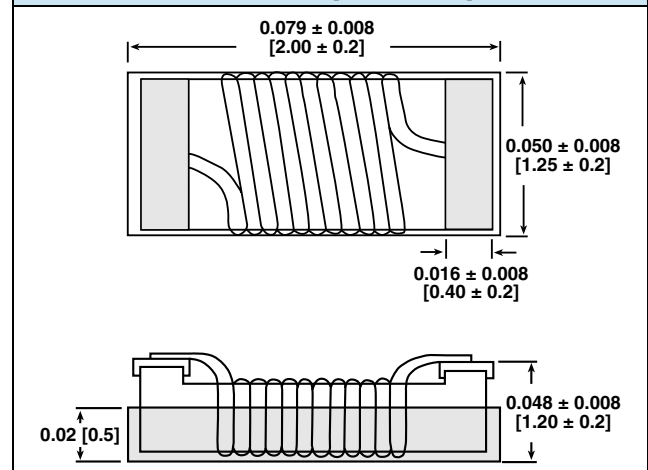
DIMENSIONS in inches [millimeters]

DESCRIPTION

IMC-0805-01	10 nH	± 5 %	ER	e4⁽¹⁾
MODEL	INDUCTANCE VALUE	INDUCTANCE TOLERANCE	PACKAGE CODE	JEDEC LEAD (Pb)-FREE STANDARD

Note

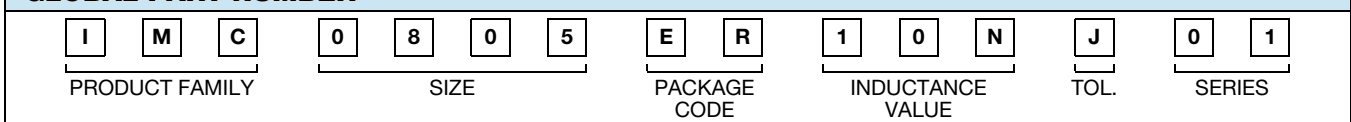
⁽¹⁾ For parts within 2.2 nH to 390 nH please use e4 for JEDEC lead (Pb)-free standard. For parts within 470 nH to 10 000 nH please use e3 for JEDEC lead (Pb)-free standard.

GLOBAL PART NUMBER

PERFORMANCE GRAPHS (IMC-0805-01)

Q VS. FREQUENCY

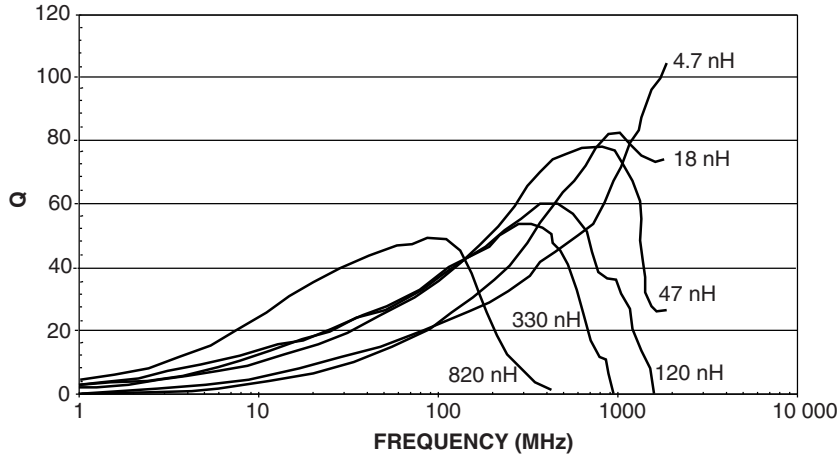

INDUCTANCE VS. FREQUENCY

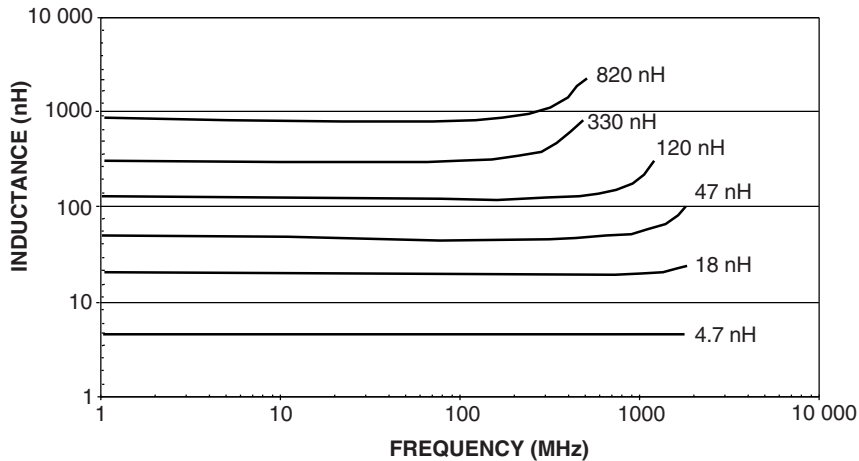

TAPE AND REEL SPECIFICATIONS in inches [millimeters]

REEL DIMENSIONS

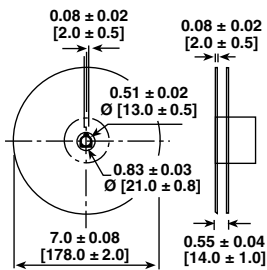

TAPE DIMENSIONS

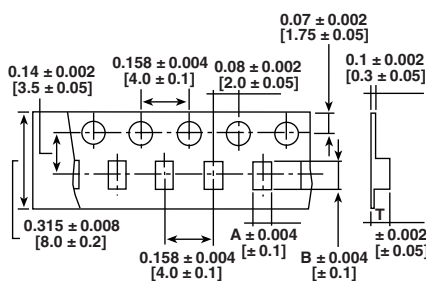

RECOMMENDED PATTERN

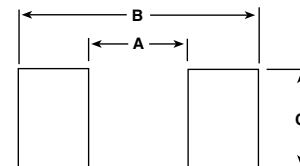

MODEL	UNITS PER REEL	MODEL	A	B	T	MODEL	A	B	C
IMC-0805-01	2000	IMC-0805-01	0.055 [1.4]	0.091 [2.3]	0.055 [1.4]	IMC-0805-01	0.047 [1.20]	0.102 [2.6]	0.047 [1.20]

High Frequency, Surface Mount Inductors



STANDARD ELECTRICAL SPECIFICATIONS							
IND. (nH)	TOL.	TEST FREQ. (MHz)		Q MIN.	SRF MIN. (MHz)	DCR MAX. (Ω)	RATED DC CURRENT (mA)
		L	Q				
3.3	0.3 nH	100	1000	50	6000	0.06	1000
6.8	5 %	100	1000	50	5500	0.06	1000
8.2	5 %	100	1000	50	5500	0.06	1000
10	5 %	100	1000	50	4300	0.08	1000
12	5 %	100	500	60	3600	0.08	1000
15	5 %	100	500	60	2700	0.08	1000
18	5 %	100	350	60	2700	0.10	1000
22	5 %	100	350	60	2500	0.10	1000
27	5 %	100	350	60	1800	0.10	1000
33	5 %	100	350	60	1700	0.10	1000
39	5 %	100	350	60	1500	0.10	1000
47	5 %	100	350	60	1500	0.10	1000
56	5 %	100	350	60	1350	0.12	1000
68	5 %	100	350	60	1300	0.15	1000
82	5 %	100	350	60	1100	0.18	1000
100	5 %	100	350	60	1100	0.18	1000
120	5 %	25	100	45	950	0.20	800
150	5 %	25	100	45	880	0.22	800
180	5 %	25	100	45	800	0.33	800
220	5 %	25	100	45	730	0.45	800
270	5 %	25	100	45	650	0.75	600
330	5 %	25	100	45	570	0.90	500
390	5 %	25	100	45	530	1.06	470
470	5 %	25	100	45	480	1.17	420
560	5 %	25	100	45	430	1.50	310
680	5 %	25	100	45	380	2.06	230
750	5 %	25	100	45	360	2.20	200
820	5 %	25	100	45	350	2.30	180
910	5 %	25	100	45	330	3.18	150
1000	5 %	25	50	35	310	3.30	120
1200	5 %	7.96	7.96	20	280	1.30	230
1500	5 %	7.96	7.96	20	250	1.65	220
1800	5 %	7.96	7.96	20	200	2.20	210
2200	5 %	7.96	7.96	20	160	2.35	200
2700	5 %	7.96	7.96	20	130	2.60	195
3300	5 %	7.96	7.96	20	80	2.85	185
3900	5 %	7.96	7.96	20	50	4.00	180
4700	5 %	7.96	7.96	20	45	4.30	175
5600	5 %	7.96	7.96	20	42	2.60	170
6800	5 %	7.96	7.96	20	39	2.80	165
8200	5 %	7.96	7.96	20	36	3.05	160
10 000	5 %	2.52	2.52	15	33	3.50	150
12 000	5 %	2.52	2.52	15	30	3.60	140
15 000	5 %	2.52	2.52	15	26	4.00	130
18 000	5 %	2.52	2.52	15	24	4.50	120
22 000	5 %	2.52	2.52	15	22	4.80	110
27 000	5 %	2.52	2.52	15	21	5.30	95
33 000	5 %	2.52	2.52	15	20	6.10	85
39 000	5 %	2.52	2.52	15	18	8.30	60
47 000	5 %	2.52	2.52	15	17	12.00	45

FEATURES

- High self-resonant frequency values
- High Q values at higher frequencies
- Wirewound construction
- Compatible with vapor phase and infrared reflow soldering
- Tape and reel packaging for automatic handling, 2000/reel
- Compliant to RoHS directive 2002/95/EC

RoHS
COMPLIANT

ELECTRICAL SPECIFICATIONS

Inductance Range: 3.3 nH to 47 000 nH
Inductance and Tolerance: 0.3 nH for 3.3 nH
 $\pm 5 \%$ for 6.8 nH to 47 000 nH
Operating Temperature: - 40 °C to + 125 °C
Core Material: Ceramic from 3.3 nH to 1000 nH
 Ferrite from 1200 nH to 47 000 nH

TEST EQUIPMENT

- Inductance and Q measured on HP4286A
- SRF measured on HP8753D

DIMENSIONS in inches [millimeters]

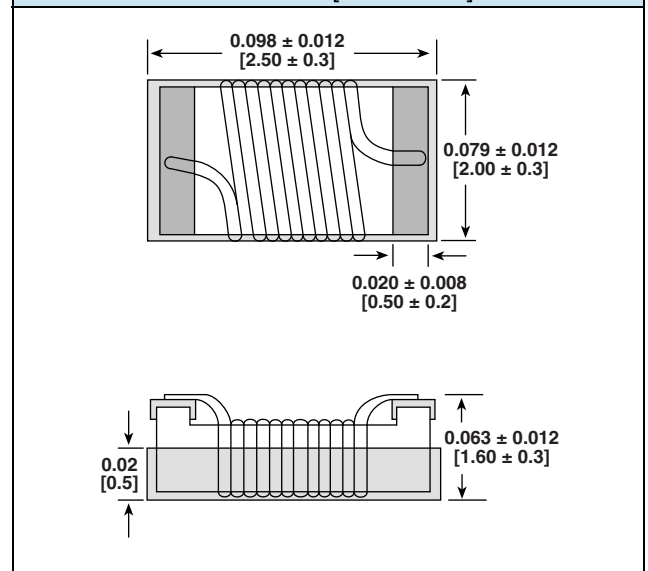

DESCRIPTION				
IMC-1008	10 nH	$\pm 5 \%$	ER	e4 ⁽¹⁾
MODEL	INDUCTANCE VALUE	INDUCTANCE TOLERANCE	PACKAGE CODE	JEDEC LEAD (Pb)-FREE STANDARD

Note

⁽¹⁾ For parts within 3.3 nH to 910 nH please use e4 for JEDEC lead (Pb)-free standard. For parts within 1000 nH to 47 000 nH please use e3 for JEDEC lead (Pb)-free standard.

GLOBAL PART NUMBER												
I	M	C	1	0	0	8	E	R	1	0	N	J
PRODUCT FAMILY			SIZE				PACKAGE CODE		INDUCTANCE VALUE			TOL.

PERFORMANCE GRAPHS IMC-1008

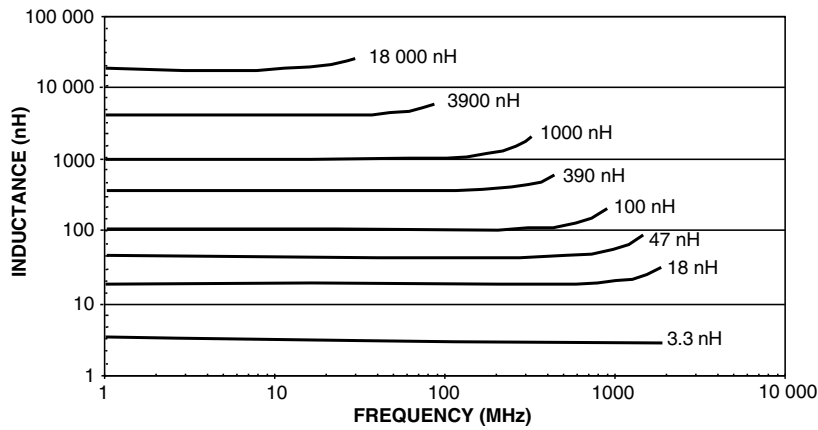
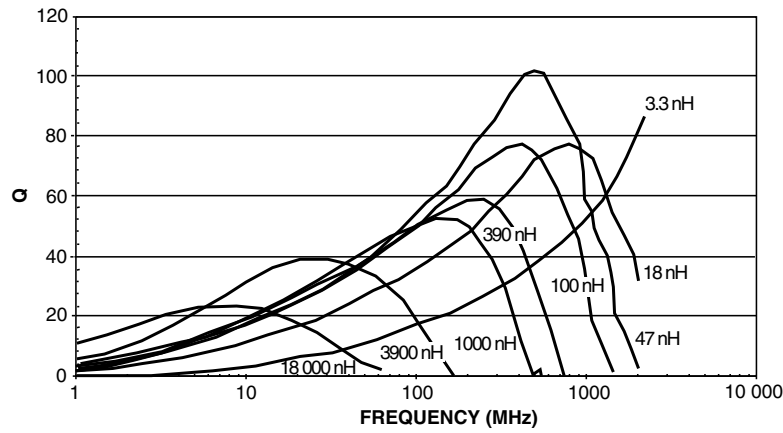

TAPE AND REEL SPECIFICATIONS in inches [millimeters]

REEL DIMENSIONS

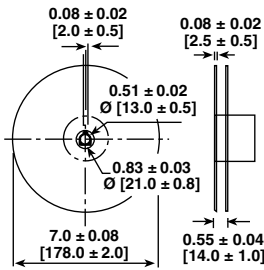

TAPE DIMENSIONS

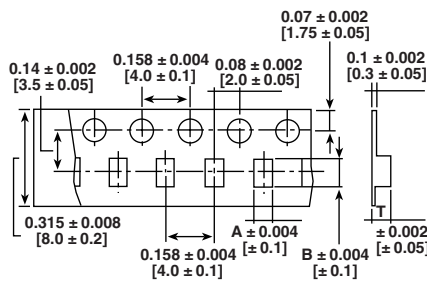

RECOMMENDED PATTERN

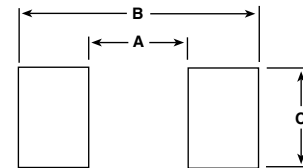

MODEL	UNITS PER REEL	MODEL	A	B	T	MODEL	A	B	C
IMC-1008	2000	IMC-1008	0.087 [2.20]	0.110 [2.80]	0.071 [1.80]	IMC-1008	0.047 [1.20]	0.150 [3.80]	0.100 [2.54]

Wirewound, Surface Mount, Shielded Inductor

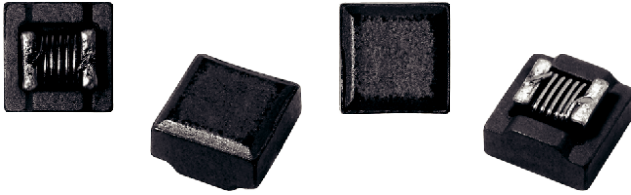

STANDARD ELECTRICAL SPECIFICATIONS					
IND. AT 100 kHz (μH)	TOL.	Q MIN. AT 1 MHz	SRF MIN. (MHz)	DCR MAX. (Ω)	RATED DC CURRENT (mA) ⁽¹⁾
1.0	± 20 %	35	344	0.05	1000
1.5	± 20 %	35	260	0.06	800
1.8	± 20 %	35	225	0.09	680
2.7	± 20 %	38	185	0.14	650
3.9	± 20 %	38	175	0.26	650
4.7	± 20 %	38	160	0.35	500
5.6	± 20 %	38	150	0.40	450
6.8	± 20 %	38	120	0.60	400
10	± 20 %	38	100	0.95	250
15	± 20 %	38	35	1.15	220
22	± 20 %	40	26	1.40	180
33	± 20 %	45	20	1.60	150
39	± 20 %	45	14	1.85	130
47	± 20 %	45	14	2.50	110
68	± 20 %	45	12	3.80	100
82	± 20 %	45	9.0	4.20	100
100	± 20 %	45	7.0	5.80	80
120	± 20 %	45	6.0	6.20	60
150	± 20 %	40	5.6	7.50	50
220	± 20 %	40	4.0	10.0	50
330	± 20 %	40	3.8	11.5	50
470	± 20 %	35	2.0	16.5	50
560	± 20 %	35	2.0	18.0	30
680	± 20 %	30	1.8	24.0	30
820	± 20 %	30	1.5	26.0	30
1000	± 20 %	30	1.3	30.0	30

Note
⁽¹⁾ For 15 °C rise

RECOMMENDED PATTERN			
LENGTH (L)	WIDTH (W)	HEIGHT (H)	TERMINAL (S)
0.142 ± 0.008 [3.60 ± 0.2]	0.142 ± 0.008 [3.60 ± 0.2]	0.098 ± 0.008 [2.50 ± 0.2]	0.020 ± 0.004 [0.50 ± 0.1]

FEATURES

- Excellent solderability and resistance to soldering heat
- Suitable for reflow soldering
- High reliability and easy surface mount assembly
- Wide range of inductance values available
- Tape and reel packaging for automatic handling, 750/reel, EIA-481
- Compliant to RoHS directive 2002/95/EC

RoHS
COMPLIANT

ELECTRICAL SPECIFICATIONS
Inductance Range: 1 μH to 1000 μH

Operating Temperature: - 40 °C to + 85 °C

Storage Temperature: - 40 °C to + 125 °C

Material: Ferrite with magnetic shield

TEST EQUIPMENT

- Inductance and Q is measured in HP-4286A RF LCR meter with HP-16193 fixture
- SRF is measured in HP-8753E RF network analyzer
- DCR is measured in HP-4338B milliohmeter

DIMENSIONS in inches [millimeters]			
LENGTH (L)	WIDTH (W)	HEIGHT (H)	TERMINAL (S)
0.142 ± 0.008 [3.60 ± 0.2]	0.142 ± 0.008 [3.60 ± 0.2]	0.098 ± 0.008 [2.50 ± 0.2]	0.020 ± 0.004 [0.50 ± 0.1]
A		B	C
0.080 ± 0.004 [2.00 ± 0.1]		0.063 ± 0.008 [1.60 ± 0.2]	0.098 ± 0.004 [2.50 ± 0.1]

DESCRIPTION				
ISC-1008	10 μH	± 20 %	ER	e3
MODEL	INDUCTANCE VALUE	INDUCTANCE TOLERANCE	PACKAGE CODE	JEDEC LEAD (Pb)-FREE STANDARD

GLOBAL PART NUMBER				
I	S	C	1	0
PRODUCT FAMILY			SIZE	
E	R	1	0	0
PACKAGE CODE		INDUCTANCE VALUE		M
				TOL.

PERFORMANCE GRAPHS ISC-1008

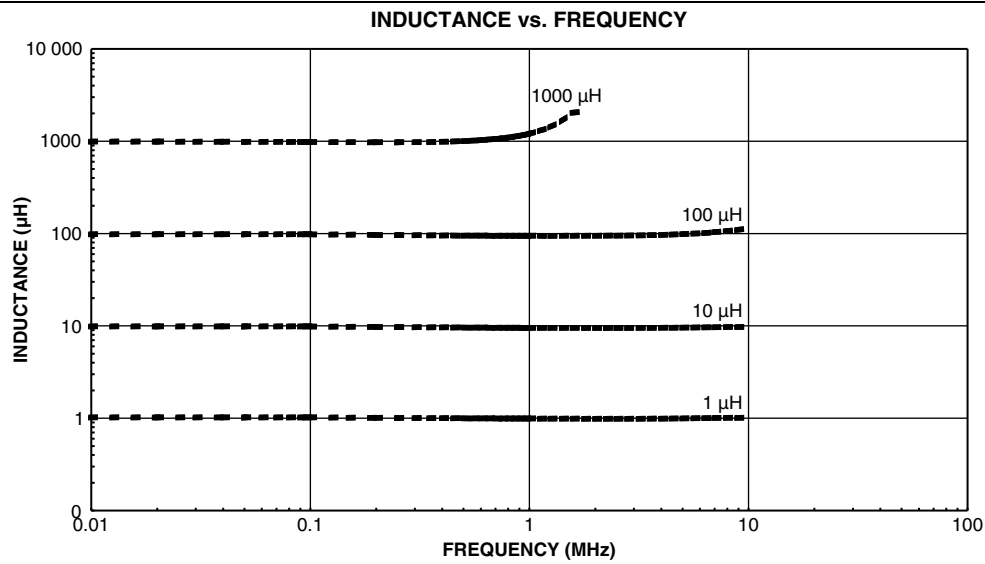
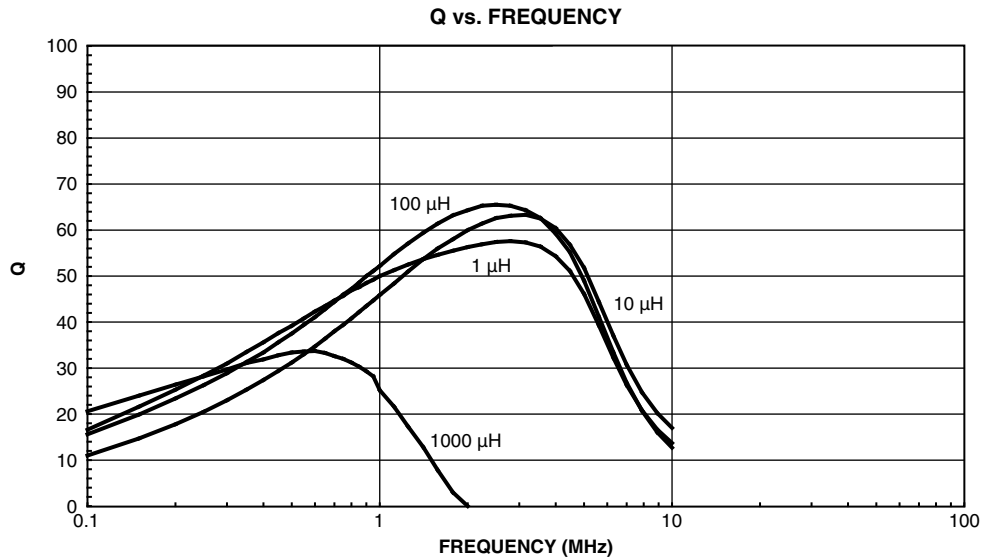

TAPE AND REEL SPECIFICATIONS in inches [millimeters]

REEL DIMENSIONS

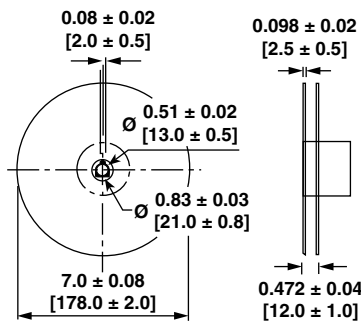

TAPE DIMENSIONS

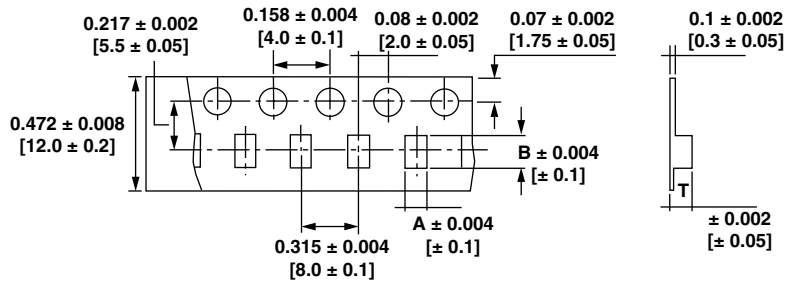

MODEL	UNITS PER REEL	MODEL	A	B	T
ISC-1008	750	ISC-1008	0.150 [3.8]	0.157 [4.0]	0.098 [2.5]

Wirewound, Surface Mount Molded Inductors



STANDARD ELECTRICAL SPECIFICATIONS						
IND. (μH)	TOL.	TEST FREQ. (MHz)	Q MIN.	SRF MIN. (MHz)	DCR MAX. (Ω)	RATED DC CURRENT (mA) ⁽¹⁾
		L & Q				
0.010	20 %	50	30	1000	0.13	734
0.012	20 %	50	30	1000	0.14	707
0.015	20 %	50	30	1000	0.16	661
0.018	20 %	50	30	1000	0.18	624
0.022	20 %	50	30	1000	0.20	592
0.027	20 %	50	30	1000	0.22	564
0.033	20 %	50	30	1000	0.24	540
0.039	20 %	50	30	1000	0.27	530
0.047	20 %	50	30	1000	0.30	483
0.056	20 %	50	30	1000	0.33	470
0.068	20 %	50	30	1000	0.36	450
0.082	20 %	50	30	900	0.40	450
0.10	20 %	50	30	700	0.44	450
0.12	20 %	25.2	30	500	0.22	584
0.15	20 %	25.2	30	450	0.25	548
0.18	20 %	25.2	30	400	0.28	518
0.22	20 %	25.2	30	350	0.32	484
0.27	20 %	25.2	30	320	0.36	456
0.33	20 %	25.2	30	300	0.40	453
0.39	20 %	25.2	30	250	0.45	450
0.47	20 %	25.2	30	220	0.50	450
0.56	20 %	25.2	30	180	0.55	450
0.68	20 %	25.2	30	160	0.60	450
0.82	20 %	25.2	30	140	0.67	450
1.0	10 %	7.96	30	120	0.70	400
1.2	10 %	7.96	30	100	0.75	390
1.5	10 %	7.96	30	85	0.85	370
1.8	10 %	7.96	30	80	0.90	350
2.2	10 %	7.96	30	75	1.0	320
2.7	10 %	7.96	30	70	1.1	290
3.3	10 %	7.96	30	60	1.2	260
3.9	10 %	7.96	30	55	1.3	250
4.7	10 %	7.96	30	50	1.5	224
5.6	10 %	7.96	30	45	1.6	217
6.8	10 %	7.96	30	40	1.8	204
8.2	10 %	7.96	30	38	2.0	194
10	10 %	2.52	30	33	2.1	189
12	10 %	2.52	30	30	2.5	173
15	10 %	2.52	30	21	2.8	164
18	10 %	2.52	30	20	3.3	151
22	10 %	2.52	30	19	3.7	145
27	10 %	2.52	30	18	5.0	122
33	10 %	2.52	30	16	6.0	112
39	10 %	2.52	30	15	7.0	104
47	10 %	2.52	30	14	9.0	91
56	10 %	2.52	30	12	10.0	87
68	10 %	2.52	30	11	11.0	83
82	10 %	2.52	30	10	12.0	79
100	10 %	0.796	20	9	14.0	73
120	10 %	0.796	15	8	11.0	70
150	10 %	0.796	15	6.5	15.0	65
180	10 %	0.796	15	6	17.0	60
220	10 %	0.796	15	6	21.0	50

Note

⁽¹⁾ Rated DC current based on the maximum temperature rise, not to exceed 40 °C at + 85 °C ambient

FEATURES

- Printed marking
- Molded construction provides superior strength and moisture resistance
- Compatible with vapor phase and infrared reflow soldering
- Tape and reel packaging for automatic handling, 2000/reel, EIA-481
- Compliant to RoHS Directive 2002/95/EC

RoHS
COMPLIANT

ELECTRICAL SPECIFICATIONS
Inductance Range: 0.01 μH to 220 μH

Inductance and Tolerance: ± 20 % for 0.01 μH to 0.82 μH, ± 10 % for 1.0 μH to 220 μH standard. Special tolerances available.

Operating Temperature: - 55 °C to + 125 °C

Coilform Material: Non-magnetic from 0.01 μH to 0.10 μH

Powdered iron from 0.12 μH to 100 μH

Ferrite from 120 μH to 220 μH

TEST EQUIPMENT

- HP4342A Q meter with Vishay Dale test fixture or equivalent
- HP4191A RF impedance analyzer (for SRF measurements)
- Wheatstone bridge

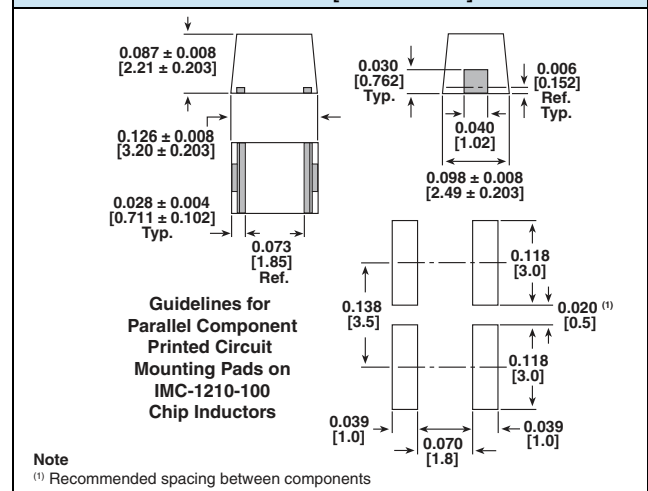
DIMENSIONS in inches [millimeters]

PART MARKING

- Vishay Dale
- Inductance value
- Date code

DESCRIPTION				
IMC-1210	10 μH	± 10 %	ER	e3
MODEL	INDUCTANCE VALUE	INDUCTANCE TOLERANCE	PACKAGE CODE	JEDEC LEAD (Pb)-FREE STANDARD
GLOBAL PART NUMBER				
I	M	C	1	2
PRODUCT FAMILY			SIZE	1
			E	R
			PACKAGE CODE	1
				0
			INDUCTANCE VALUE	0
				K
			TOL.	

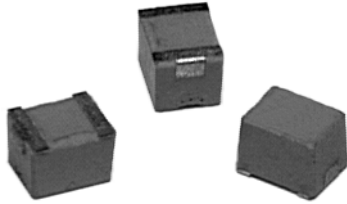
Wirewound, Surface Mount Molded Inductors



FEATURES

- Printed marking
- Molded construction provides superior strength and moisture resistance
- Compatible with vapor phase and infrared reflow soldering
- Tape and reel packaging for automatic handling, 2000/reel, EIA-481
- Compliant to RoHS directive 2002/95/EC



ELECTRICAL SPECIFICATIONS

Inductance and Tolerance: ± 20 % for 0.010 µH to 0.100 µH standard.
 ± 10 % for 0.010 µH to 0.100 µH
 ± 5 % for 0.027 µH to 0.100 µH optional.

Operating Temperature: - 55 °C to + 125 °C

Core Material: Non-magnetic from 0.010 µH to 0.100 µH

TEST EQUIPMENT

- L, Q, SRF: HP4191A RF impedance analyzer
- DCR: Wheatstone bridge or equivalent

STANDARD ELECTRICAL SPECIFICATIONS					
IND. (µH)	TEST FREQ. (MHz)	Q MIN.	SRF MIN. (MHz) ⁽¹⁾	DCR MAX. (Ω)	RATED DC CURRENT (mA)
	L & Q				
0.010	100	15	2500	0.13	734
0.012	100	17	2300	0.14	707
0.015	100	19	2100	0.16	661
0.018	100	21	1900	0.18	624
0.022	100	23	1700	0.20	592
0.027	100	23	1500	0.22	564
0.033	100	25	1400	0.24	540
0.039	100	25	1300	0.27	530
0.047	100	26	1200	0.30	483
0.056	100	26	1100	0.33	470
0.068	100	27	1000	0.36	450
0.082	100	27	900	0.40	450
0.10	100	28	700	0.44	450

Note

⁽¹⁾ All SRF values above 1000 MHz are typical minimums.

PART MARKING

- Vishay Dale
- Inductance value
- Date code

DIMENSIONS in inches [millimeters]

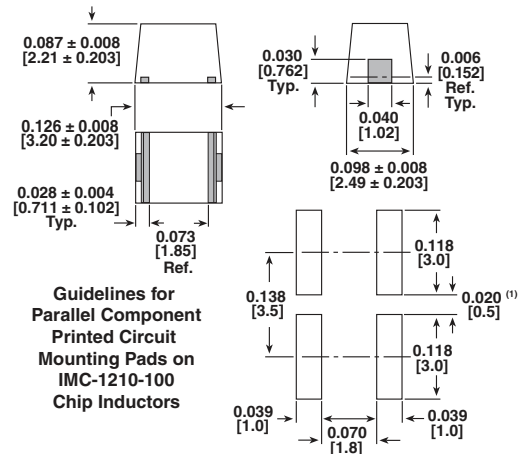

Guidelines for Parallel Component Printed Circuit Mounting Pads on IMC-1210-100 Chip Inductors

Note

⁽¹⁾ Recommended spacing between components

DESCRIPTION

IMC-1210-100	0.010 µH	± 20 %	ER	e3
MODEL	INDUCTANCE VALUE	INDUCTANCE TOLERANCE	PACKAGE CODE	JEDEC LEAD (Pb)-FREE STANDARD

GLOBAL PART NUMBER

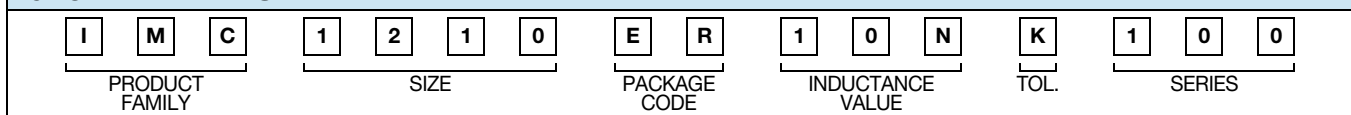

Wirewound, Surface Mount, Molded, Shielded Inductors



STANDARD ELECTRICAL SPECIFICATIONS						
IND. (μH)	TOL.	TEST FREQ. (MHz)	Q MIN.	SRF MIN. (MHz)	DCR MAX. (Ω)	RATED DC CURRENT (mA) ⁽¹⁾
		L & Q				
0.010	± 20 %	50	50	1000	0.10	810
0.012	± 20 %	50	50	1000	0.11	750
0.015	± 20 %	50	50	1000	0.12	720
0.018	± 20 %	50	50	1000	0.13	690
0.022	± 20 %	50	45	1000	0.15	640
0.027	± 20 %	50	45	1000	0.17	610
0.033	± 20 %	50	45	1000	0.18	585
0.039	± 20 %	50	40	1000	0.24	530
0.047	± 20 %	50	40	1000	0.26	495
0.056	± 20 %	50	40	1000	0.28	485
0.068	± 20 %	50	40	1000	0.35	475
0.082	± 20 %	50	38	900	0.45	460
0.10	± 20 %	50	36	700	0.50	450
0.12	± 20 %	25.2	40	500	0.20	630
0.15	± 20 %	25.2	40	470	0.20	600
0.18	± 20 %	25.2	40	400	0.24	580
0.22	± 20 %	25.2	40	330	0.30	565
0.27	± 20 %	25.2	40	310	0.33	500
0.33	± 20 %	25.2	40	280	0.36	475
0.39	± 20 %	25.2	40	230	0.40	465
0.47	± 20 %	25.2	40	220	0.44	460
0.56	± 20 %	25.2	40	200	0.46	455
0.68	± 20 %	25.2	40	180	0.48	450
0.82	± 20 %	25.2	40	160	0.50	450
1.0	± 10 %	7.96	30	120	0.60	400
1.2	± 10 %	7.96	30	110	0.65	390
1.5	± 10 %	7.96	30	90.0	0.75	370
1.8	± 10 %	7.96	30	85.0	0.85	350
2.2	± 10 %	7.96	30	65.0	0.90	320
2.7	± 10 %	7.96	30	60.0	1.00	290
3.3	± 10 %	7.96	30	60.0	1.10	270
3.9	± 10 %	7.96	30	58.0	1.20	250
4.7	± 10 %	7.96	30	52.0	1.25	220
5.6	± 10 %	7.96	30	50.0	1.40	210
6.8	± 10 %	7.96	30	40.0	1.60	205
8.2	± 10 %	7.96	30	35.0	1.65	195
10.0	± 10 %	2.52	30	30.0	2.00	185
12.0	± 10 %	2.52	30	24.0	2.30	175
15.0	± 10 %	2.52	30	20.0	2.50	165
18.0	± 10 %	2.52	30	17.0	2.70	155
22.0	± 10 %	2.52	30	16.0	3.10	150
27.0	± 10 %	2.52	30	14.5	3.30	125
33.0	± 10 %	2.52	30	14.5	5.10	115
39.0	± 10 %	2.52	30	14.0	5.90	105
47.0	± 10 %	2.52	30	13.0	8.00	100
56.0	± 10 %	2.52	30	11.5	10.0	95
68.0	± 10 %	2.52	30	11.0	10.0	90
82.0	± 10 %	2.52	30	11.0	11.0	85
100.0	± 10 %	0.796	30	6.0	12.0	80

Note

⁽¹⁾ Rated DC current based on the maximum temperature rise, not to exceed 40 °C at + 85 °C ambient

FEATURES

- Molded construction provides superior strength and moisture resistance
- Tape and reel packaging for automatic handling, 2000/reel, EIA-481
- Compatible with vapor phase, infrared and wave soldering methods
- Shielded construction minimizes coupling to other components
- Compliant to RoHS Directive 2002/95/EC
- Halogen-free according to IEC 61249-2-21 definition



RoHS
COMPLIANT
HALOGEN
FREE

ELECTRICAL SPECIFICATIONS

Inductance Range: 0.01 μH to 100 μH

Inductance Tolerance: ± 20 % for 0.01 μH to 0.82 μH; ± 10 % for 1.0 μH to 100 μH standard; ± 5 %, ± 3 % available

Operating Temperature: - 55 °C to + 125 °C

Coilform Material: Non-magnetic for 0.01 μH to 0.10 μH; powdered iron for 0.12 μH to 100 μH

TEST EQUIPMENT

- H/P 4342A Q meter with Vishay Dale test fixture or equivalent
- H/P 4191A RF impedance analyzer (for SRF measurements)
- Wheatstone bridge

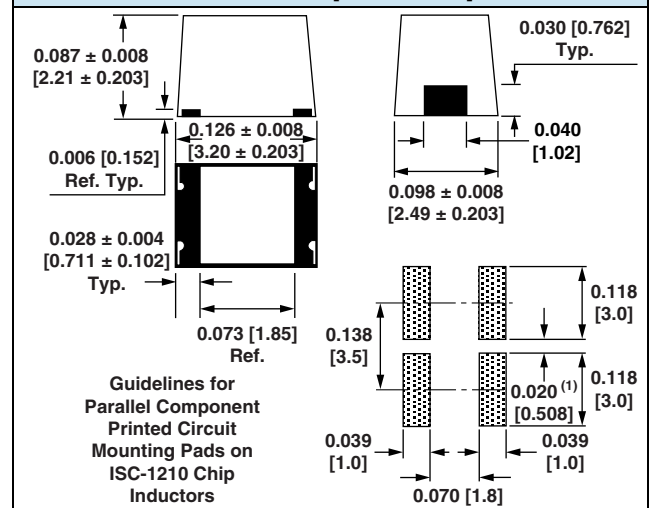
DIMENSIONS in inches [millimeters]

Note

⁽¹⁾ Recommended minimum spacing between components

PART MARKING

- Vishay Dale
- Inductance value
- Date code

DESCRIPTION

ISC-1210	10 μH	± 10 %	ER	e3
MODEL	INDUCTANCE VALUE	INDUCTANCE TOLERANCE	PACKAGE CODE	JEDEC LEAD (Pb)-FREE STANDARD

GLOBAL PART NUMBER

I	S	C	1	2	1	0	E	R	1	0	0	K
PRODUCT FAMILY			SIZE				PACKAGE CODE		INDUCTANCE VALUE			TOL.

Wirewound, Surface Mount, Molded Inductors

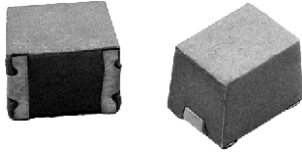

FEATURES

- Molded construction provides superior strength and moisture resistance
- Tape and reel packaging for automatic handling, 2000/reel, EIA-481
- Printed marking
- Compatible with vapor phase and infrared reflow soldering
- Compliant to RoHS Directive 2002/95/EC

RoHS
COMPLIANT

STANDARD ELECTRICAL SPECIFICATIONS

IND. (μ H)	TOL.	TEST FREQ. (MHz)		SRF MIN. (MHz)	DCR MAX. (Ω)	RATED DC CURRENT (mA) ⁽¹⁾
		L & Q	Q MIN.			
0.010	$\pm 20\%$	50.0	50	1000	0.20	450
0.012	$\pm 20\%$	50.0	50	1000	0.20	450
0.018	$\pm 20\%$	50.0	50	1000	0.20	450
0.022	$\pm 20\%$	50.0	50	1000	0.20	450
0.027	$\pm 20\%$	50.0	50	1000	0.20	450
0.033	$\pm 20\%$	50.0	50	1000	0.30	450
0.039	$\pm 20\%$	50.0	50	1000	0.30	450
0.047	$\pm 20\%$	50.0	50	1000	0.30	450
0.056	$\pm 20\%$	50.0	40	900	0.35	450
0.068	$\pm 20\%$	50.0	40	800	0.35	450
0.082	$\pm 20\%$	50.0	40	700	0.40	450
0.10	$\pm 20\%$	25.2	30	650	0.32	450
0.12	$\pm 20\%$	25.2	30	600	0.30	450
0.15	$\pm 20\%$	25.2	30	500	0.30	450
0.18	$\pm 20\%$	25.2	30	400	0.35	450
0.22	$\pm 20\%$	25.2	30	350	0.40	450
0.27	$\pm 20\%$	25.2	30	300	0.45	450
0.33	$\pm 20\%$	25.2	30	250	0.55	430
0.39	$\pm 20\%$	25.2	30	220	0.70	380
0.47	$\pm 10\%$	25.2	30	190	0.80	355
0.56	$\pm 10\%$	25.2	30	170	1.20	285
0.68	$\pm 10\%$	25.2	30	150	1.40	270
0.82	$\pm 10\%$	25.2	30	140	1.60	250
1.0	$\pm 10\%$	7.96	50	100	0.50	450
1.2	$\pm 10\%$	7.96	50	80.0	0.55	430
1.5	$\pm 10\%$	7.96	50	70.0	0.60	410
1.8	$\pm 10\%$	7.96	50	60.0	0.65	390
2.2	$\pm 10\%$	7.96	50	55.0	0.70	380
2.7	$\pm 10\%$	7.96	50	50.0	0.75	370
3.3	$\pm 10\%$	7.96	50	45.0	0.80	355
3.9	$\pm 10\%$	7.96	50	40.0	0.90	330
4.7	$\pm 10\%$	7.96	50	35.0	1.00	315
5.6	$\pm 10\%$	7.96	50	33.0	1.10	300
6.8	$\pm 10\%$	7.96	50	27.0	1.20	285
8.2	$\pm 10\%$	7.96	50	25.0	1.40	270
10.0	$\pm 10\%$	2.52	50	20.0	1.60	250
12.0	$\pm 10\%$	2.52	50	18.0	2.00	225
15.0	$\pm 10\%$	2.52	50	17.0	2.50	200
18.0	$\pm 10\%$	2.52	50	15.0	2.80	190
22.0	$\pm 10\%$	2.52	50	13.0	3.20	180
27.0	$\pm 10\%$	2.52	50	12.0	3.60	170
33.0	$\pm 10\%$	2.52	50	11.0	4.00	160
39.0	$\pm 10\%$	2.52	50	11.0	4.50	150
47.0	$\pm 10\%$	2.52	50	10.0	5.00	140
56.0	$\pm 10\%$	2.52	50	9.0	5.50	135
68.0	$\pm 10\%$	2.52	50	9.0	6.00	130
82.0	$\pm 10\%$	2.52	50	8.0	7.00	120
100.0	$\pm 10\%$	0.79	40	8.0	8.00	110
120.0	$\pm 10\%$	0.79	40	6.0	8.00	110
150.0	$\pm 10\%$	0.79	40	5.0	9.00	105
180.0	$\pm 10\%$	0.79	40	5.0	9.50	102
220.0	$\pm 10\%$	0.79	40	4.0	10.0	100
270.0	$\pm 10\%$	0.79	40	4.0	12.0	92
330.0	$\pm 10\%$	0.79	40	3.5	14.0	85
390.0	$\pm 10\%$	0.79	40	3.0	16.0	80
470.0	$\pm 10\%$	0.79	40	3.0	26.0	62
560.0	$\pm 10\%$	0.79	30	3.0	30.0	50
680.0	$\pm 10\%$	0.79	30	3.0	30.0	50
820.0	$\pm 10\%$	0.79	30	2.5	35.0	30
1000.0	$\pm 10\%$	0.25	30	2.5	40.0	30

Note

⁽¹⁾ Rated DC current based on the maximum temperature rise, not to exceed 40 °C at + 85 °C ambient

ELECTRICAL SPECIFICATIONS

Inductance Range: 0.010 μ H to 1000 μ H

Inductance Tolerance: $\pm 20\%$ for 0.010 μ H to 0.39 μ H
 $\pm 10\%$ for 0.47 μ H to 1000 μ H standard
 $\pm 10\%$, $\pm 5\%$, $\pm 3\%$ available

Operating Temperature: - 55 °C to + 125 °C

Coilform Material: Non-magnetic for 0.010 μ H to 0.82 μ H
 Powdered iron for 1.0 μ H to 120 μ H
 Ferrite for 150 μ H to 1000 μ H

TEST EQUIPMENT

- H/P 4342A Q meter with Vishay Dale test fixture or equivalent
- H/P 4191A RF impedance analyzer (for SRF measurements)
- Wheatstone bridge

DIMENSIONS in inches [millimeters]

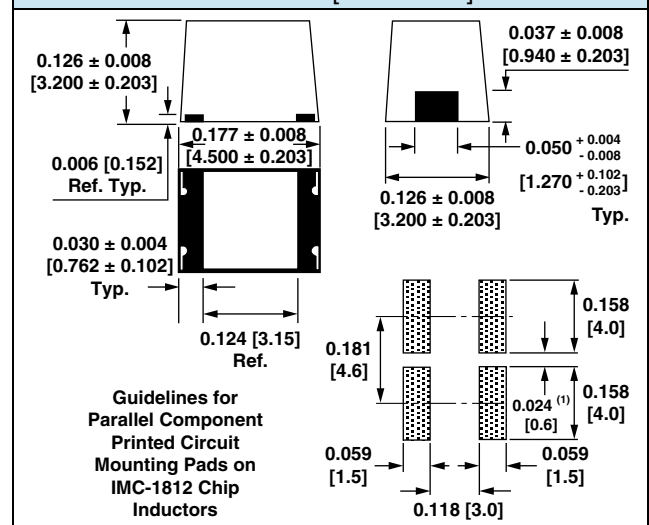
Note

⁽²⁾ Recommended minimum spacing between components

PART MARKING

- Vishay Dale
- Inductance value
- Date code



DESCRIPTION

IMC-1812	10 μH	$\pm 10\%$	ER	e3
MODEL	INDUCTANCE VALUE	INDUCTANCE TOLERANCE	PACKAGE CODE	JEDEC LEAD (Pb)-FREE STANDARD

GLOBAL PART NUMBER

I M C	1 8 1 2	E R	1 0 0	K
PRODUCT FAMILY	SIZE	PACKAGE CODE	INDUCTANCE VALUE	TOL.

Wirewound, Surface Mount, Molded, Shielded Inductors

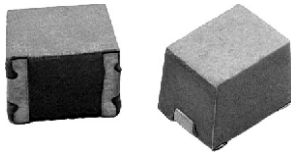

STANDARD ELECTRICAL SPECIFICATIONS						
IND. (μH)	TOL.	TEST FREQ. (MHz)	Q MIN.	SRF MIN. (MHz)	DCR MAX. (Ω)	RATED DC CURRENT (mA) ⁽¹⁾
		L & Q				
0.1	± 20 %	25.2	30	460	0.23	552
0.1	± 20 %	25.2	30	400	0.26	519
0.2	± 20 %	25.2	30	390	0.29	491
0.2	± 20 %	25.2	30	350	0.32	468
0.2	± 20 %	25.2	30	310	0.36	441
0.3	± 20 %	25.2	30	280	0.40	418
0.3	± 20 %	25.2	30	240	0.45	394
0.4	± 20 %	25.2	30	215	0.60	342
0.5	± 20 %	25.2	30	205	0.75	306
0.6	± 20 %	25.2	30	195	0.80	296
0.7	± 20 %	25.2	30	165	0.95	271
0.8	± 20 %	25.2	30	155	1.20	242
1.0	± 10 %	7.96	30	140	0.35	447
1.2	± 10 %	7.96	30	120	0.38	429
1.5	± 10 %	7.96	30	100	0.40	418
1.8	± 10 %	7.96	30	90.0	0.43	403
2.2	± 10 %	7.96	30	80.0	0.46	390
2.7	± 10 %	7.96	30	67.0	0.49	378
3.3	± 10 %	7.96	30	61.0	0.55	357
3.9	± 10 %	7.96	30	56.0	0.59	344
4.7	± 10 %	7.96	30	50.0	0.62	336
5.6	± 10 %	7.96	30	40.0	0.69	333
6.8	± 10 %	7.96	30	32.0	0.75	306
8.2	± 10 %	7.96	30	30.0	0.82	292
10.0	± 10 %	2.52	50	25.0	0.90	279
12.0	± 10 %	2.52	50	22.0	1.00	265
15.0	± 10 %	2.52	50	18.0	1.10	252
18.0	± 10 %	2.52	50	15.0	1.24	238
22.0	± 10 %	2.52	50	14.0	1.36	227
27.0	± 10 %	2.52	50	13.0	1.56	212
33.0	± 10 %	2.52	50	12.0	1.72	202
39.0	± 10 %	2.52	50	11.0	1.89	192
47.0	± 10 %	2.52	50	9.0	2.10	183
56.0	± 10 %	2.52	50	8.0	2.34	173
68.0	± 10 %	2.52	50	7.6	2.60	164
82.0	± 10 %	2.52	50	7.2	2.86	156
100.0	± 10 %	0.796	40	7.0	3.25	147
120.0	± 10 %	0.796	40	6.0	3.64	139
150.0	± 10 %	0.796	40	5.0	4.16	130
180.0	± 10 %	0.796	40	4.5	5.72	111
220.0	± 10 %	0.796	40	4.2	6.30	105
270.0	± 10 %	0.796	40	4.0	6.90	101
330.0	± 10 %	0.796	40	3.7	7.54	96
390.0	± 10 %	0.796	40	3.5	8.20	92
470.0	± 10 %	0.796	40	3.3	9.20	87
560.0	± 10 %	0.796	30	2.8	10.50	82
680.0	± 10 %	0.796	40	2.6	12.00	76
820.0	± 10 %	0.796	30	2.2	13.50	72
1000.0	± 10 %	0.252	30	2.0	16.00	66

Note

⁽¹⁾ Rated DC current based on the maximum temperature rise, not to exceed 40 °C at + 85 °C ambient

FEATURES

- Molded construction provides superior strength and moisture resistance
- Tape and reel packaging for automatic handling, 2000/reel, EIA-481
- Compatible with vapor phase and infrared reflow soldering
- Shielded construction minimizes coupling to other components
- Compliant to RoHS Directive 2002/95/EC
- Halogen-free according to IEC 61249-2-21 definition



ELECTRICAL SPECIFICATIONS

Inductance Range: 0.10 μH to 1000 μH
Inductance Tolerance: ± 20 % for 0.10 μH to 0.82 μH
 ± 10 % for 1.0 μH to 1000 μH standard
 ± 10 %, ± 5 %, ± 3 % available
Operating Temperature: - 55 °C to + 125 °C
Coilform Material: Non-magnetic for 0.10 μH to 0.82 μH
 Powdered iron for 1.0 μH to 22 μH
 Ferrite for 27 μH to 1000 μH

TEST EQUIPMENT

- H/P 4342A Q meter with Vishay Dale test fixture or equivalent
- H/P 4191A RF impedance analyzer (for SRF measurements)
- Wheatstone bridge

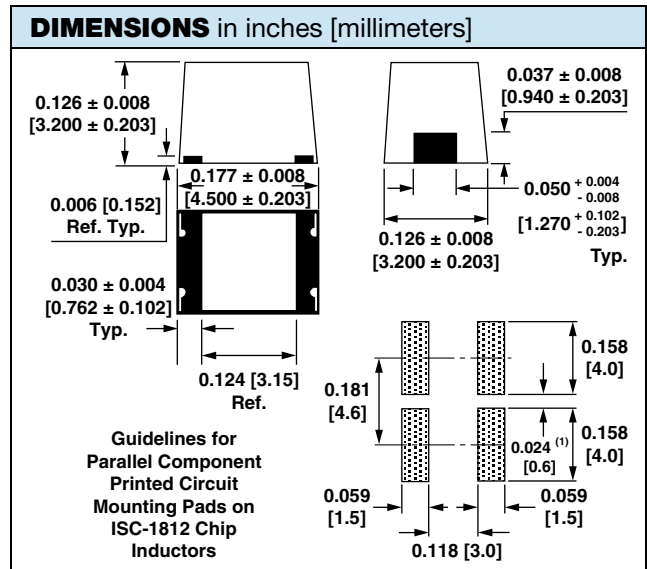

Note

⁽¹⁾ Recommended minimum spacing between components

PART MARKING	
-	Vishay Dale
-	Inductance value
-	Date code



COUPLING SPECIFICATIONS (maximum)

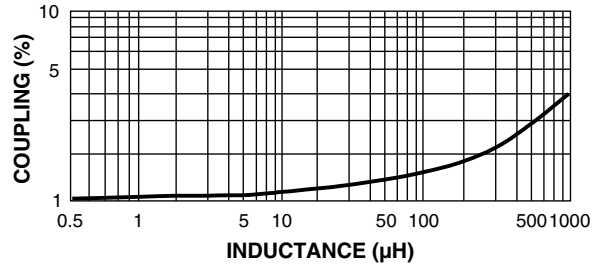

DESCRIPTION

ISC-1812	10 μH	± 10 %	ER	e3
MODEL	INDUCTANCE VALUE	INDUCTANCE TOLERANCE	PACKAGE CODE	JEDEC LEAD (Pb)-FREE STANDARD

GLOBAL PART NUMBER

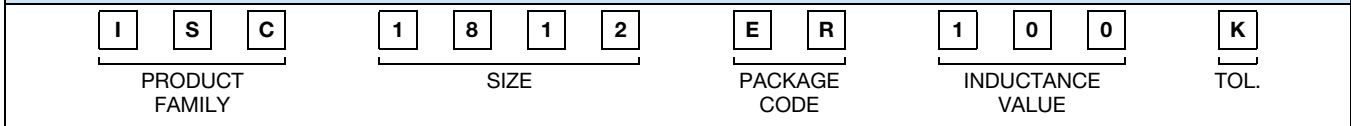

Wirewound, Surface Mount, Molded Inductors



STANDARD ELECTRICAL SPECIFICATIONS						
IND. (μH)	TOL.	TEST FREQ. (MHz)	Q MIN.	SRF MIN. (MHz)	DCR MAX. (Ω)	RATED DC CURRENT (mA) ⁽¹⁾
		L & Q				
1.0	± 10 %	7.96	10	200	0.11	1050
1.2	± 10 %	7.96	10	160	0.12	1000
1.5	± 10 %	7.96	10	130	0.15	950
1.8	± 10 %	7.96	10	100	0.16	900
2.2	± 10 %	7.96	10	60.0	0.18	850
2.7	± 10 %	7.96	10	60.0	0.20	800
3.3	± 10 %	7.96	10	45.0	0.22	750
3.9	± 10 %	7.90	10	40.0	0.24	700
4.7	± 10 %	7.96	10	35.0	0.3	650
5.6	± 10 %	7.96	10	30.0	0.3	650
6.8	± 10 %	7.96	10	28.0	0.4	600
8.2	± 10 %	7.96	10	25.0	0.4	600
10	± 10 %	2.52	10	22.0	0.5	550
12	± 10 %	2.52	10	21.0	0.6	500
15	± 10 %	2.52	10	20.0	0.7	450
18	± 10 %	2.52	10	19.0	0.8	400
22	± 10 %	2.52	10	18.0	0.9	370
27	± 10 %	2.52	10	16.0	1.2	330
33	± 10 %	2.52	10	14.0	1.4	300
39	± 10 %	2.52	10	12.0	1.6	280
47	± 10 %	2.52	10	11.5	1.9	260
56	± 10 %	2.52	10	11.0	2.2	240
68	± 10 %	2.52	10	10.0	2.6	220
82	± 10 %	2.52	10	9.0	3.5	200
100	± 10 %	0.796	20	8.0	4.0	180
120	± 10 %	0.796	20	6.5	4.5	160
150	± 10 %	0.796	20	7.0	6.5	140
180	± 10 %	0.796	20	5.5	7.5	120
220	± 10 %	0.796	20	5.5	9	120
270	± 10 %	0.796	20	5.0	11	100
330	± 10 %	0.796	20	4.0	13	90

Note

⁽¹⁾ Rated DC current based on the maximum temperature rise, not to exceed 40 °C at + 85 °C ambient

FEATURES

- Molded construction provides superior strength and moisture resistance
- Tape and reel packaging for automatic handling, 500/reel, EIA-481
- Compatible with vapor phase, infrared and wave soldering methods
- Compliant to RoHS Directive 2002/95/EC

**RoHS
COMPLIANT**
ELECTRICAL SPECIFICATIONS
Inductance Range: 1 μH to 330 μH

Inductance Tolerance: ± 10 %

Operating Temperature: - 40 °C to + 85 °C

Storage Temperature: - 40 °C to + 100 °C

TEST EQUIPMENT

- L & Q: H/P 4285A
- SRF: H/P 4286A
- DCR: H/P 34401

DIMENSIONS in inches [millimeters]

A	B	C
0.177 ± 0.012 [4.5 ± 0.3]	0.126 ± 0.012 [3.2 ± 0.3]	0.126 ± 0.012 [3.2 ± 0.3]
D	E	
0.055 ± 0.016 [1.4 ± 0.4]	0.035 ± 0.008 [0.9 ± 0.2]	

PART MARKING

- Inductance value

DESCRIPTION

IMCH-1812	22 μH	± 10 %	ER	e3
MODEL	INDUCTANCE VALUE	INDUCTANCE TOLERANCE	PACKAGE CODE	JEDEC LEAD (Pb)-FREE STANDARD

GLOBAL PART NUMBER

I	M	C	H	1	8	1	2	E	R	2	2	0	K
PRODUCT FAMILY				SIZE				PACKAGE CODE		INDUCTANCE VALUE			TOL.

High Frequency, Surface Mount Molded Inductors

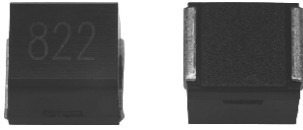

STANDARD ELECTRICAL SPECIFICATIONS

IND. (μ H)	TOL.	TEST FREQ. (MHz)	Q MIN.	SRF MIN. (MHz)	DCR MAX. (Ω)	RATED DC CURRENT (mA) ⁽¹⁾
		L & Q				
1.0	10 %	7.96	10	95	0.030	1800
1.2	10 %	7.96	10	70	0.035	1700
1.5	10 %	7.96	10	55	0.040	1600
1.8	10 %	7.96	10	47	0.050	1400
2.2	10 %	7.96	10	42	0.060	1300
2.7	10 %	7.96	10	37	0.070	1200
3.3	10 %	7.96	10	34	0.080	1120
3.9	10 %	7.96	10	32	0.090	1050
4.7	10 %	7.96	10	29	0.110	950
5.6	10 %	7.96	10	26	0.130	880
6.8	10 %	7.96	10	24	0.150	810
8.2	10 %	7.96	10	22	0.180	750
10	10 %	2.52	10	19	0.210	690
12	10 %	2.52	10	17	0.250	630
15	10 %	2.52	10	16	0.300	580
18	10 %	2.52	10	14	0.360	530
22	10 %	2.52	10	13	0.430	480
27	10 %	2.52	10	11.5	0.520	440
33	10 %	2.52	10	10.5	0.620	400
39	10 %	2.52	10	9.5	0.720	370
47	10 %	2.52	10	8.5	0.850	340
56	10 %	2.52	10	7.8	1.00	310
68	10 %	2.52	10	7	1.20	290
82	10 %	2.52	10	6.4	1.40	270
100	10 %	0.796	20	6	1.60	250
120	10 %	0.796	20	5.4	1.90	230
150	10 %	0.796	20	4.8	2.20	210
180	10 %	0.796	20	4.4	2.80	190
220	10 %	0.796	20	3.9	3.40	170
270	10 %	0.796	20	3.6	4.20	155
330	10 %	0.796	20	3.2	4.90	140
390	10 %	0.796	20	2.9	5.80	130
470	10 %	0.796	20	2.6	7.00	120
560	10 %	0.796	20	2.4	8.50	110
680	10 %	0.796	20	2.2	10.0	100
820	10 %	0.796	20	2	13.0	90
1000	10 %	0.252	20	1.8	15.0	85
1200	5 %	0.252	20	1.5	17.0	75
1500	5 %	0.252	20	1.4	20.0	70
1800	5 %	0.252	20	1.3	30.0	60
2200	5 %	0.252	20	1.2	35.0	55
2700	5 %	0.252	20	1.1	55.0	45
3300	5 %	0.252	20	1	60.0	40
3900	5 %	0.252	20	1	70.0	38
4700	5 %	0.252	20	0.9	78.0	36
5600	5 %	0.252	20	0.8	85.0	33
6800	5 %	0.252	20	0.7	110.0	30
8200	5 %	0.252	20	0.6	125.0	28
10 000	5 %	0.0796	15	0.5	150.0	25

Note

⁽¹⁾ Rated DC current based on the maximum temperature rise, not to exceed 40 °C at + 85 °C ambient

FEATURES

- Molded construction provides superior strength and moisture resistance
- Compatible with vapor phase infrared and wave soldering methods (100 % tin plating)
- Tape and reel packaging for automatic handling, 2000/reel
- Compliant to RoHS Directive 2002/95/EC

RoHS
COMPLIANT

ELECTRICAL SPECIFICATIONS
Inductance Range: 1.0 μ H to 10 000 μ H

Inductance and Tolerance: \pm 10 %, \pm 5 %

Operating Temperature: - 40 °C to + 125 °C

Storage Temperature: - 40 °C to + 125 °C

TEST EQUIPMENT

- Inductance and Q measured on HP4191
- SRF measured on HP3755
- DCR measured on HP34401

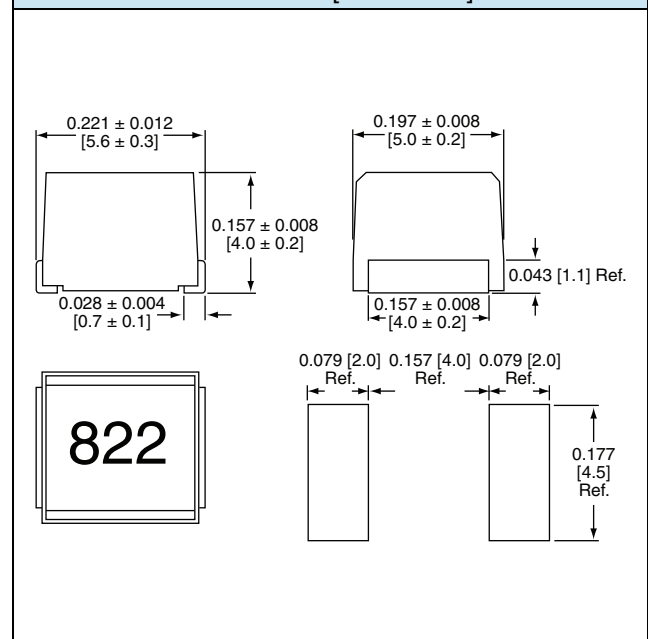
DIMENSIONS in inches [millimeters]

DESCRIPTION

IMC-2220	22 μH	\pm 10 %	ER	E3
MODEL	INDUCTANCE VALUE	INDUCTANCE TOLERANCE	PACKAGE CODE	JEDEC LEAD (Pb)-FREE STANDARD

GLOBAL PART NUMBER

I	M	C	2	2	2	0	E	R	2	2	0	K
PRODUCT FAMILY			SIZE				PACKAGE CODE		INDUCTANCE VALUE			TOL.



Common Mode Chokes

Contents

ICM-0805	196
ICM-1206	197
ICM-2824, ICM-3528, ICM-4743	198

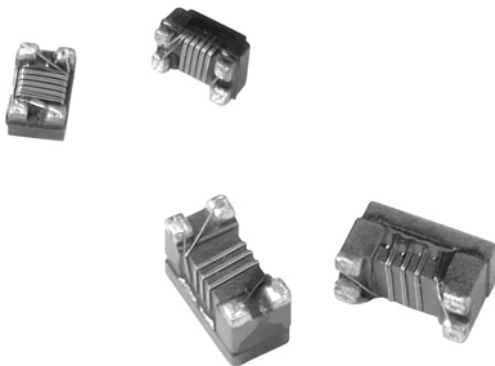

Surface Mount Common Mode Choke



FEATURES

- Operating temperature - 40 °C to + 85 °C
- Excellent solderability and resistance to soldering heat
- Suitable for flow and reflow soldering
- High reliability and easy surface mount assembly
- Compliant to RoHS directive 2002/95/EC



RoHS
COMPLIANT

APPLICATIONS

- USB 2.0 and IEEE1394
- Notebook and personal computer
- Digital camera
- Scanner

STANDARD ELECTRICAL SPECIFICATIONS

COMMON MODE IMPEDANCE AT 100 MHz, ± 20 % (Ω) ⁽¹⁾	RATED VOLTAGE (V _{DC})	WITHSTANDING VOLTAGE (V _{DC})	RATED CURRENT MAX. (mA) ⁽²⁾	DC RESISTANCE MAX. (Ω)	INSULATION RESISTANCE MIN. (MΩ)
30	50	125	450	0.20	10
67	50	125	400	0.25	10
90	50	125	330	0.35	10
120	50	125	370	0.30	10
160	50	125	350	0.35	10
180	50	125	330	0.35	10
260	50	125	300	0.40	10
370	50	125	280	0.45	10

Notes

- ⁽¹⁾ Impedance is measured in HP4287A at a frequency of 100 MHz.
⁽²⁾ For a 15 °C rise.

DIMENSIONS in inches [millimeters]

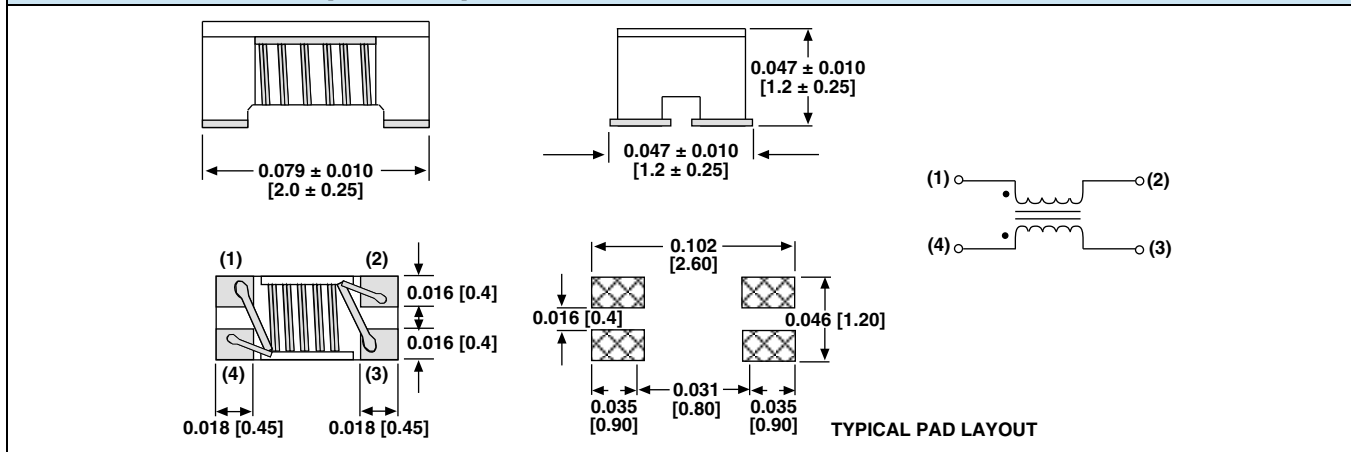

DESCRIPTION

ICM-0805	120	± 20 %	ER	e3
MODEL	IMPEDANCE VALUE	INDUCTANCE TOLERANCE	PACKAGE CODE	JEDEC LEAD (Pb)-FREE STANDARD

GLOBAL PART NUMBER

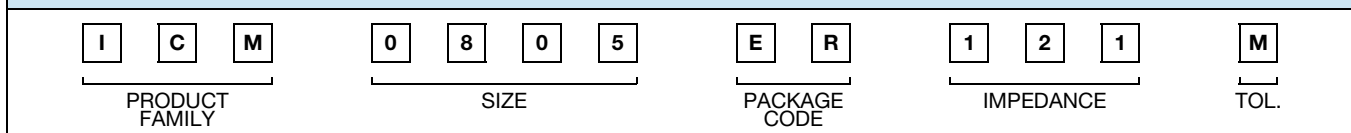

Surface Mount Common Mode Choke



FEATURES

- Operating temperature - 40 °C to + 85 °C
- Excellent solderability and resistance to soldering heat
- Suitable for flow and reflow soldering
- High reliability and easy surface mount assembly
- Compliant to RoHS directive 2002/95/EC

RoHS
COMPLIANT

APPLICATIONS

- USB 2.0 and IEEE1394
- Notebook and personal computer
- Digital camera
- Scanner

STANDARD ELECTRICAL SPECIFICATIONS

COMMON MODE IMPEDANCE AT 100 MHz, ± 20 % (Ω) ⁽¹⁾	RATED VOLTAGE (V _{DC})	WITHSTANDING VOLTAGE (V _{DC})	RATED CURRENT MAX. (mA) ⁽²⁾	DC RESISTANCE MAX. (Ω)	INSULATION RESISTANCE MIN. (MΩ)
90	50	125	370	0.3	10
160	50	125	340	0.4	10
260	50	125	310	0.5	10
600	50	125	260	0.8	10
1000	50	125	230	1.0	10
2200	50	125	200	1.2	10

Notes

⁽¹⁾ Impedance is measured in HP4287A at a frequency of 100 MHz.

⁽²⁾ For a 15 °C rise.

DIMENSIONS in inches [millimeters]

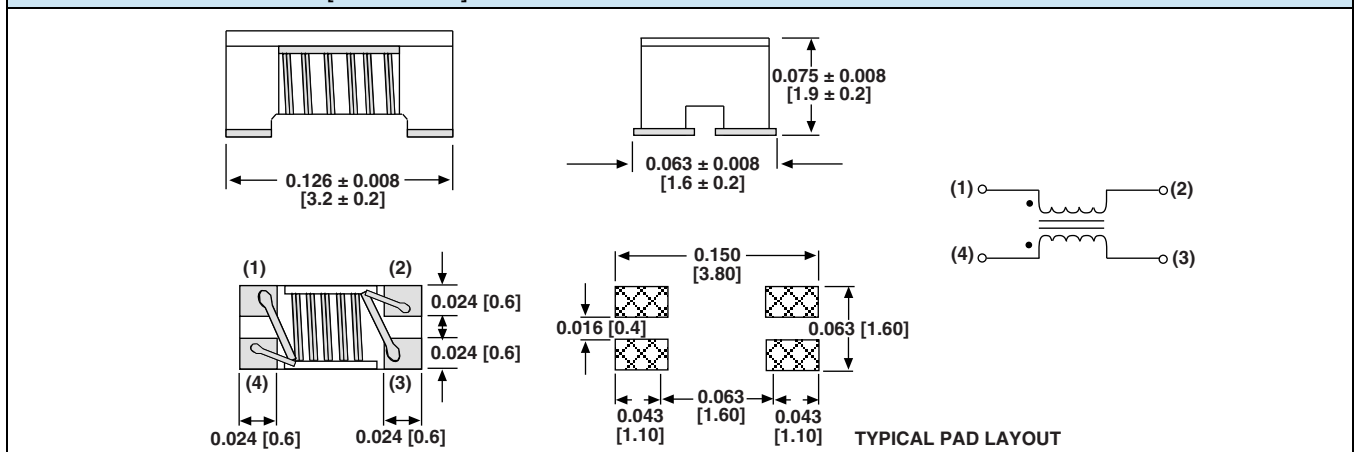

DESCRIPTION

ICM-1206	600	± 20 %	ER	e3
MODEL	IMPEDANCE VALUE	INDUCTANCE TOLERANCE	PACKAGE CODE	JEDEC LEAD (Pb)-FREE STANDARD

GLOBAL PART NUMBER

I	C	M	1	2	0	6	E	R	6	0	1	M
PRODUCT FAMILY			SIZE				PACKAGE CODE		IMPEDANCE			TOL.

High Current Common Mode Choke



FEATURES

- SMD high current common mode choke for DC power line
- Base terminals are treated, allows for easy mounting on PCB
- Paired wire coil for high stability
- Optimized for transmission of high quality signals
- Operating Temperature: - 25 °C to + 85 °C
- Rated Current: Based on temp. rise; ΔT : 40 °C, typical
- Compliant to RoHS Directive 2002/95/EC

RoHS
COMPLIANT

APPLICATIONS

- LAN's, telephones, personal computers
- CD-ROM drives, electronic games
- Other electronic devices

STANDARD ELECTRICAL SPECIFICATIONS

PART NUMBER	COMMON MODE IMPEDANCE AT 100 MHz \pm 25 % (Ω)	RATED VOLTAGE MAX. (V _{DC})	RATED CURRENT MAX. (mA)	DC RESISTANCE MAX. (Ω)	INSULATION RESISTANCE MIN. (M Ω)
ICM2824ER301V	300	80	5000	0.01	10
ICM2824ER701V	700	80	4000	0.015	10
ICM3528ER701V	700	80	5000	0.01	10
ICM3528ER152V	1500	80	4500	0.015	10
ICM4743ER701V	700	80	8000	0.006	10
ICM4743ER102V	1000	80	6000	0.014	10

DIMENSIONS in inches [millimeters]

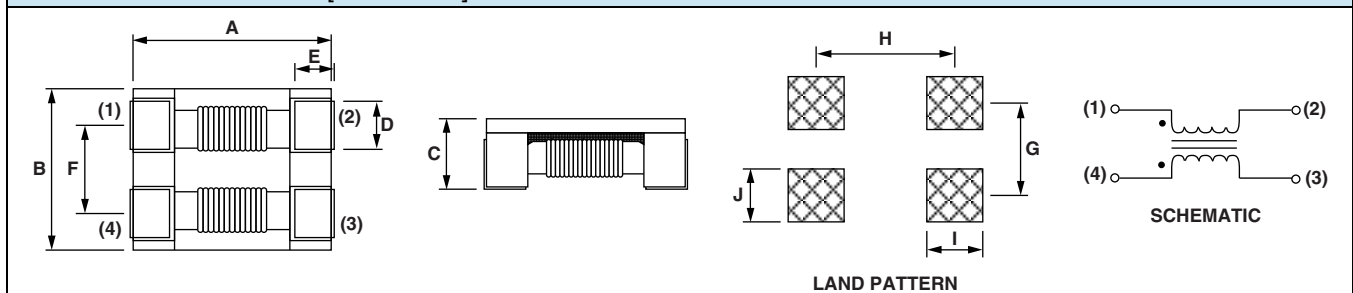

LAND PATTERN

PART NUMBER	A	B	C	D	E	F	G	H	I	J
ICM-2824	0.276 \pm 0.012 [7.0 \pm 0.3]	0.236 \pm 0.008 [6.0 \pm 0.2]	0.157 [4.0] max.	0.063 \pm 0.012 [1.6 \pm 0.3]	0.071 \pm 0.012 [1.8 \pm 0.3]	0.118 [3.0] typ.	0.118 [3.0] ref.	0.256 [6.5] ref.	0.098 [2.5] ref.	0.063 [1.6] ref.
ICM-3528	0.354 \pm 0.020 [9.0 \pm 0.5]	0.276 \pm 0.012 [7.0 \pm 0.3]	0.197 [5.0] max.	0.060 \pm 0.008 [1.5 \pm 0.2]	0.060 \pm 0.008 [1.5 \pm 0.2]	0.138 [3.5] typ.	0.138 [3.5] ref.	0.335 [8.5] ref.	0.098 [2.5] ref.	0.071 [1.8] ref.
ICM-4743	0.472 \pm 0.20 [12.0 \pm 0.5]	0.433 \pm 0.012 [11.0 \pm 0.3]	0.248 [6.3] max.	0.106 \pm 0.008 [2.7 \pm 0.2]	0.091 \pm 0.008 [2.3 \pm 0.2]	0.205 [5.2] typ.	0.205 [5.2] ref.	0.374 [9.5] ref.	0.177 [4.5] ref.	0.106 [2.7] ref.

DESCRIPTION

ICM-3528	700	25 %	ER	e3
MODEL	IMPEDANCE VALUE	TOLERANCE	PACKAGE CODE	JEDEC LEAD (Pb)-FREE STANDARD

GLOBAL PART NUMBER

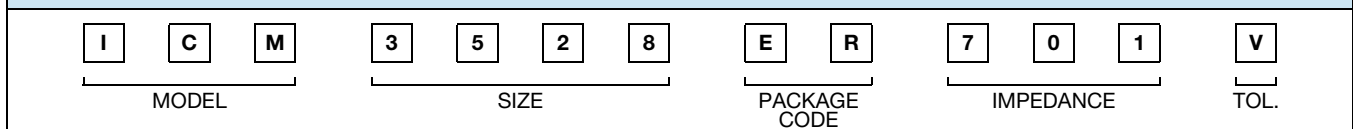



Multilayer Ferrite Inductors and Beads

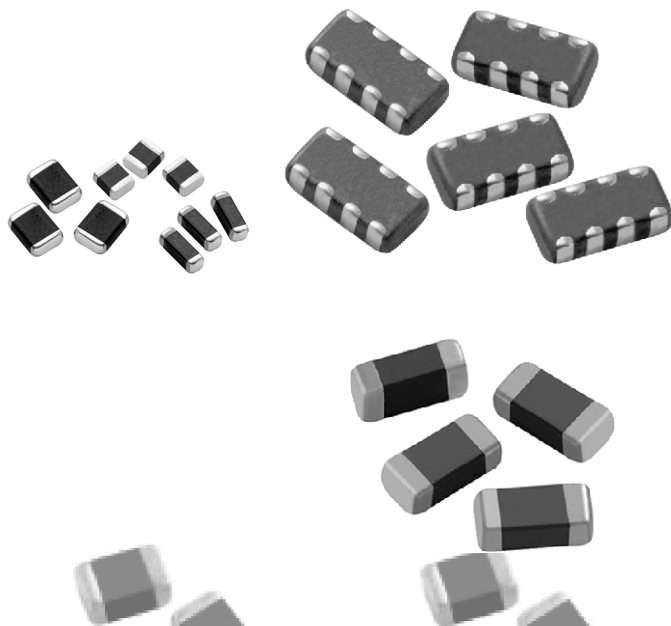

Contents

ILSB-0603	200
ILSB-0805	202
ILSB-1206	204
ILBB-0402	206
ILBB-0603	209
ILBB-0805	212
ILB-1206.....	217
ILBB-1210, ILBB-1806, ILBB-1812	221
ILHB	223
ILAS-1206	227

Monolithic Chip Inductors

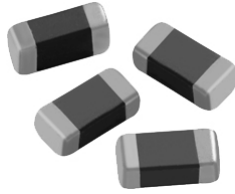

MECHANICAL SPECIFICATIONS

Solderability: 90 % coverage after 5 s dip in 235 °C solder following 60 s preheat at 120 °C to 150 °C and type R flux dip

Resistance to Solder Heat: 10 s in 260 °C solder, after preheat and flux per above

Termination: 100 % Sn

Terminal Strength: 0.5 kg for 30 s

Beam Strength: 0.3 kg

FEATURES

- High reliability
- Surface mountable
- Magnetically self shielded
- Nickel barrier plating virtually eliminates silver migration
- Compliant to RoHS Directive 2002/95/EC
- Halogen-free according to IEC 61249-2-21 definition



RoHS
COMPLIANT
HALOGEN
FREE

ENVIRONMENTAL SPECIFICATIONS

Operating Temperature: - 55 °C to + 125 °C

Thermal Shock: - 40 °C to + 85 °C

Humidity: 90 % RH at 40 °C, 1000 h at full rated current

Load Life: 85 °C for 1000 h at full rated current

STANDARD ELECTRICAL SPECIFICATIONS

IND. AT ± 10 % (µH)	TOL.	THICKNESS "D" (INCHES [mm])	TEST FREQ. (MHz)	Q MIN.	SRF MIN. (MHz)	DCR MAX. (Ω)	RATED DC CURRENT (mA)
			L & Q				
0.047	20 %	0.031 ± 0.008 [0.80 ± 0.2]	50	10	260	0.15	50
0.068	20 %	0.031 ± 0.008 [0.80 ± 0.2]	50	10	250	0.25	50
0.082	20 %	0.031 ± 0.008 [0.80 ± 0.2]	50	10	245	0.25	50
0.10	10 %	0.031 ± 0.008 [0.80 ± 0.2]	25	15	276	0.50	50
0.12	10 %	0.031 ± 0.008 [0.80 ± 0.2]	25	15	236	0.50	50
0.15	10 %	0.031 ± 0.008 [0.80 ± 0.2]	25	15	207	0.60	50
0.18	10 %	0.031 ± 0.008 [0.80 ± 0.2]	25	15	190	0.60	50
0.22	10 %	0.031 ± 0.008 [0.80 ± 0.2]	25	15	173	0.80	50
0.27	10 %	0.031 ± 0.008 [0.80 ± 0.2]	25	15	157	0.80	50
0.33	10 %	0.031 ± 0.008 [0.80 ± 0.2]	25	15	144	0.85	35
0.39	10 %	0.031 ± 0.008 [0.80 ± 0.2]	25	15	127	1.00	35
0.47	10 %	0.031 ± 0.008 [0.80 ± 0.2]	25	15	121	1.35	35
0.56	10 %	0.031 ± 0.008 [0.80 ± 0.2]	25	15	110	1.55	35
0.68	10 %	0.031 ± 0.008 [0.80 ± 0.2]	25	15	104	1.70	35
0.82	10 %	0.031 ± 0.008 [0.80 ± 0.2]	25	15	98	2.10	35
1.0	10 %	0.031 ± 0.008 [0.80 ± 0.2]	10	35	87	0.60	25
1.2	10 %	0.031 ± 0.008 [0.80 ± 0.2]	10	35	74	0.80	25
1.5	10 %	0.031 ± 0.008 [0.80 ± 0.2]	10	35	69	0.80	25
1.8	10 %	0.031 ± 0.008 [0.80 ± 0.2]	10	35	64	0.95	25
2.2	10 %	0.031 ± 0.008 [0.80 ± 0.2]	10	35	58	1.15	15
2.7	10 %	0.031 ± 0.008 [0.80 ± 0.2]	10	35	52	1.35	15
3.3	10 %	0.031 ± 0.008 [0.80 ± 0.2]	10	35	46	1.55	15
3.9	10 %	0.031 ± 0.008 [0.80 ± 0.2]	10	35	41	1.70	15
4.7	10 %	0.031 ± 0.008 [0.80 ± 0.2]	10	35	38	2.10	15
5.6	10 %	0.031 ± 0.008 [0.80 ± 0.2]	4	30	22	1.55	15
6.8	10 %	0.031 ± 0.008 [0.80 ± 0.2]	4	30	20	1.70	15
8.2	10 %	0.031 ± 0.008 [0.80 ± 0.2]	4	30	18	2.10	15
10	10 %	0.031 ± 0.008 [0.80 ± 0.2]	2	30	17	2.55	15

DESCRIPTION

ILSB-0603	3.3 µH	± 10 %	ER	e3
MODEL	INDUCTANCE VALUE	INDUCTANCE TOLERANCE	PACKAGE CODE	JEDEC LEAD (Pb)-FREE STANDARD

GLOBAL PART NUMBER

I	L	S	B	0	6	0	3	E	R	3	R	3	K
PRODUCT FAMILY				SIZE				PACKAGE CODE		INDUCTANCE VALUE			TOL.

DIMENSIONS in inches [millimeters]

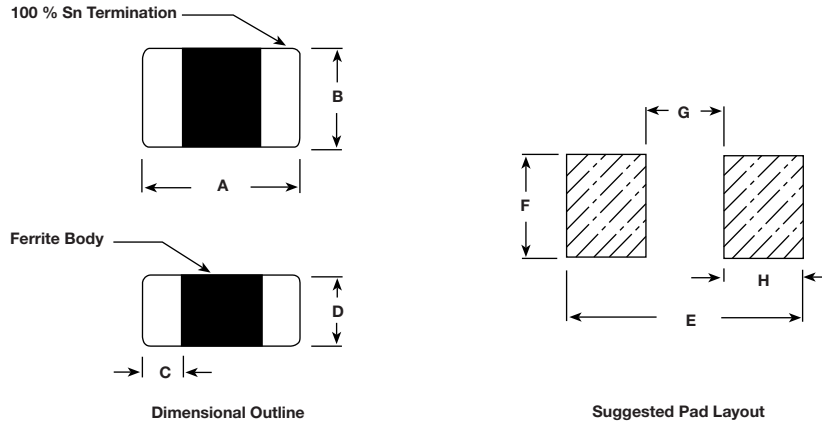

A	B	C	D	E	F	G	H
0.063 ± 0.006 [1.6 ± 0.15]	0.031 ± 0.006 [0.8 ± 0.15]	0.012 ± 0.006 [0.3 ± 0.15]	0.031 ± 0.008 [0.8 ± 0.2]	0.105 [2.7]	0.035 [0.9]	0.025 [0.64]	0.040 [1.0]

TAPE AND REEL SPECIFICATIONS 0603 SIZE PER EIA-481-1 in inches [millimeters]

4000 Piece/Reel

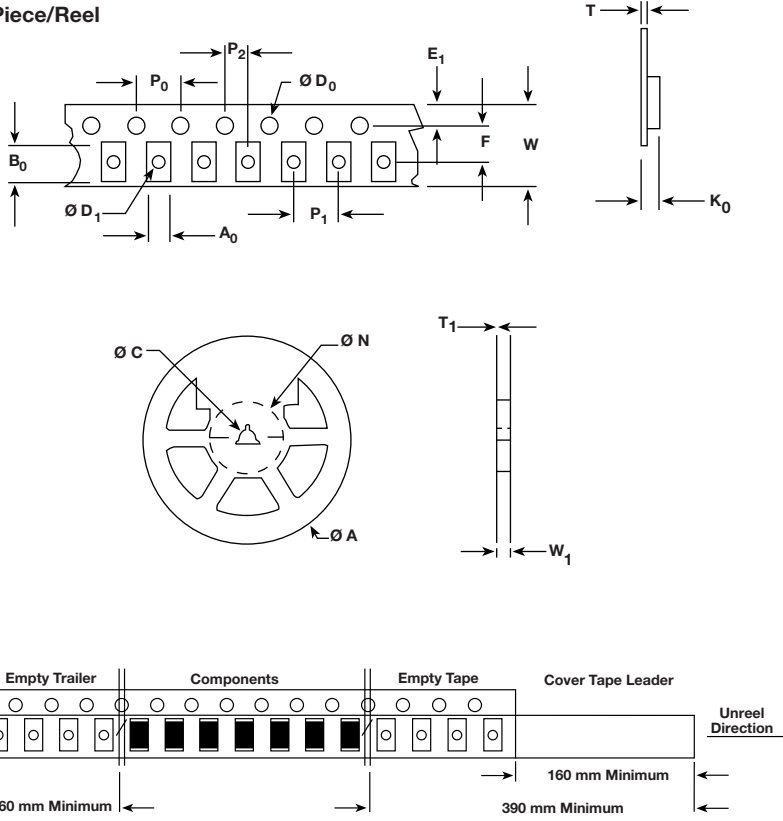

A ₀	0.045 ± 0.004 [1.14 ± 0.1]
B ₀	0.068 ± 0.004 [1.75 ± 0.1]
D ₀	0.059 + 0.005/- 0.000 [1.5 + 0.127]
D ₁	0.039 min. [1.0 min.]
E ₁	0.069 ± 0.004 [1.75 ± 0.1]
F	0.138 ± 0.002 [3.50 ± 0.05]
K ₀	0.045 ± 0.002 [1.15 ± 0.05]
P ₀	0.157 ± 0.004 [4.00 ± 0.1]
P ₁	0.157 ± 0.004 [4.00 ± 0.1]
P ₂	0.079 ± 0.002 [2.00 ± 0.05]
W	0.327 max. [8.3 max.]
T	0.008 ± 0.002 [0.2 ± 0.05]
A	7.000 ± 0.079 [178 ± 2.0]
N	2.500 [63.5]
C	0.512 ± 0.020 [13.00 ± 0.50]
W ₁	0.315 + 0.059/- 0.000 [8.00 + 1.5]
T ₁	0.079 ± 0.002 [2.00 ± 0.05]

Monolithic Chip Inductors

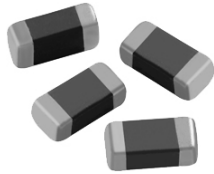

MECHANICAL SPECIFICATIONS

Solderability: 90 % coverage after 5 s dip in 235 °C solder following 60 s preheat at 120 °C to 150 °C and type R flux dip

Resistance to Solder Heat: 10 s in 260 °C solder, after preheat and flux per above

Termination: 100 % Sn

Terminal Strength: 0.6 kg for 30 s

Beam Strength: 1.0 kg

FEATURES

- High reliability
- Surface mountable
- Magnetically self shielded
- Nickel barrier plating virtually eliminates silver migration
- Compliant to RoHS Directive 2002/95/EC
- Halogen-free according to IEC 61249-2-21 definition



RoHS
COMPLIANT
HALOGEN
FREE

ENVIRONMENTAL SPECIFICATIONS

Operating Temperature: - 55 °C to + 125 °C

Thermal Shock: - 40 °C to + 85 °C

Humidity: 90 % RH at 40 °C, 1000 h at full rated current

Load Life: 85 °C for 1000 h at full rated current

STANDARD ELECTRICAL SPECIFICATIONS

IND. AT ± 10 % (µH)	TOL.	THICKNESS "D" (INCHES [mm])	TEST FREQ. (MHz)	Q MIN.	SRF MIN. (MHz)	DCR MAX. (Ω)	RATED DC CURRENT (mA)
			L & Q				
0.047	20 %	0.035 ± 0.008 [0.90 ± 0.2]	50	15	320	0.20	300
0.056	20 %	0.035 ± 0.008 [0.90 ± 0.2]	50	15	300	0.20	300
0.068	20 %	0.035 ± 0.008 [0.90 ± 0.2]	50	15	280	0.20	300
0.082	20 %	0.035 ± 0.008 [0.90 ± 0.2]	50	15	255	0.20	300
0.10	10 %	0.035 ± 0.008 [0.90 ± 0.2]	25	20	279	0.30	250
0.12	10 %	0.035 ± 0.008 [0.90 ± 0.2]	25	20	253	0.30	250
0.15	10 %	0.035 ± 0.008 [0.90 ± 0.2]	25	20	230	0.40	250
0.18	10 %	0.035 ± 0.008 [0.90 ± 0.2]	25	20	213	0.40	250
0.22	10 %	0.035 ± 0.008 [0.90 ± 0.2]	25	20	196	0.50	250
0.27	10 %	0.035 ± 0.008 [0.90 ± 0.2]	25	20	173	0.50	250
0.33	10 %	0.035 ± 0.008 [0.90 ± 0.2]	25	20	167	0.55	250
0.39	10 %	0.035 ± 0.008 [0.90 ± 0.2]	25	25	156	0.65	200
0.47	10 %	0.035 ± 0.008 [0.90 ± 0.2]	25	25	144	0.65	200
0.56	10 %	0.035 ± 0.008 [0.90 ± 0.2]	25	25	133	0.75	150
0.68	10 %	0.035 ± 0.008 [0.90 ± 0.2]	25	25	121	0.80	150
0.82	10 %	0.035 ± 0.008 [0.90 ± 0.2]	25	25	115	1.00	150
1.0	10 %	0.035 ± 0.008 [0.90 ± 0.2]	10	45	87	0.40	50
1.2	10 %	0.035 ± 0.008 [0.90 ± 0.2]	10	45	75	0.50	50
1.5	10 %	0.035 ± 0.008 [0.90 ± 0.2]	10	45	69	0.50	50
1.8	10 %	0.035 ± 0.008 [0.90 ± 0.2]	10	45	64	0.60	50
2.2	10 %	0.035 ± 0.008 [0.90 ± 0.2]	10	45	58	0.65	30
2.7	10 %	0.049 ± 0.008 [1.25 ± 0.2]	10	45	52	0.75	30
3.3	10 %	0.049 ± 0.008 [1.25 ± 0.2]	10	45	48	0.80	30
3.9	10 %	0.049 ± 0.008 [1.25 ± 0.2]	10	45	44	0.90	30
4.7	10 %	0.049 ± 0.008 [1.25 ± 0.2]	10	45	41	1.00	30
5.6	10 %	0.049 ± 0.008 [1.25 ± 0.2]	4	45	37	0.90	15
6.8	10 %	0.049 ± 0.008 [1.25 ± 0.2]	4	45	34	1.00	15
8.2	10 %	0.049 ± 0.008 [1.25 ± 0.2]	4	45	30	1.10	15
10	10 %	0.049 ± 0.008 [1.25 ± 0.2]	2	50	28	1.15	15
12	10 %	0.049 ± 0.008 [1.25 ± 0.2]	2	50	26	1.25	15
15	10 %	0.049 ± 0.008 [1.25 ± 0.2]	1	30	22	0.80	5
18	10 %	0.049 ± 0.008 [1.25 ± 0.2]	1	30	21	0.90	5
22	10 %	0.049 ± 0.008 [1.25 ± 0.2]	1	30	19	1.10	5
27	10 %	0.049 ± 0.008 [1.25 ± 0.2]	1	30	17	1.15	5
33	10 %	0.049 ± 0.008 [1.25 ± 0.2]	0.4	30	13	1.25	5

DESCRIPTION

ILSB-0805	3.3 µH	± 10 %	ER	e3
MODEL	INDUCTANCE VALUE	INDUCTANCE TOLERANCE	PACKAGE CODE	JEDEC LEAD (Pb)-FREE STANDARD

GLOBAL PART NUMBER

I	L	S	B	0	8	0	5	E	R	3	R	3	K
PRODUCT FAMILY				SIZE				PACKAGE CODE		INDUCTANCE VALUE			TOL.

Monolithic Chip Inductors



MECHANICAL SPECIFICATIONS

Solderability: 90 % coverage after 5 s dip in 235 °C solder following 60 s preheat at 120 °C to 150 °C and type R flux dip

Resistance to Solder Heat: 10 s in 260 °C solder, after preheat and flux per above

Termination: 100 % Sn

Terminal Strength: 0.1 kg for 30 s

Beam Strength: 2.5 kg

FEATURES

- High reliability
- Surface mountable
- Magnetically self shielded
- Nickel barrier plating virtually eliminates silver migration
- Compliant to RoHS Directive 2002/95/EC
- Halogen-free according to IEC 61249-2-21 definition



RoHS
COMPLIANT
HALOGEN
FREE

ENVIRONMENTAL SPECIFICATIONS

Operating Temperature: - 55 °C to + 125 °C

Thermal Shock: - 40 °C to + 85 °C

Humidity: 90 % RH at 40 °C, 1000 h at full rated current

Load Life: 85 °C for 1000 h at full rated current

STANDARD ELECTRICAL SPECIFICATIONS

IND. AT ± 10 % (μH)	TOL.	THICKNESS "D" (INCHES [mm])	TEST FREQ. (MHz)	Q MIN.	SRF MIN. (MHz)	DCR MAX. (Ω)	RATED DC CURRENT (mA)
			L & Q				
0.047	20 %	0.043 ± 0.012 [1.10 ± 0.3]	50	20	368	0.15	300
0.068	20 %	0.043 ± 0.012 [1.10 ± 0.3]	50	20	322	0.25	300
0.10	10 %	0.043 ± 0.012 [1.10 ± 0.3]	25	20	271	0.25	250
0.12	10 %	0.043 ± 0.012 [1.10 ± 0.3]	25	20	253	0.30	250
0.15	10 %	0.043 ± 0.012 [1.10 ± 0.3]	25	20	230	0.30	250
0.18	10 %	0.043 ± 0.012 [1.10 ± 0.3]	25	20	213	0.40	250
0.22	10 %	0.043 ± 0.012 [1.10 ± 0.3]	25	20	196	0.40	250
0.27	10 %	0.043 ± 0.012 [1.10 ± 0.3]	25	20	173	0.50	250
0.33	10 %	0.043 ± 0.012 [1.10 ± 0.3]	25	20	167	0.60	250
0.39	10 %	0.043 ± 0.012 [1.10 ± 0.3]	25	25	156	0.50	200
0.47	10 %	0.043 ± 0.012 [1.10 ± 0.3]	25	25	144	0.60	200
0.68	10 %	0.043 ± 0.012 [1.10 ± 0.3]	25	25	121	0.80	150
1.0	10 %	0.043 ± 0.012 [1.10 ± 0.3]	10	45	87	0.40	100
1.2	10 %	0.043 ± 0.012 [1.10 ± 0.3]	10	45	75	0.50	100
1.5	10 %	0.043 ± 0.012 [1.10 ± 0.3]	10	45	69	0.50	50
1.8	10 %	0.043 ± 0.012 [1.10 ± 0.3]	10	45	64	0.50	50
2.2	10 %	0.043 ± 0.012 [1.10 ± 0.3]	10	45	58	0.50	50
3.3	10 %	0.043 ± 0.012 [1.10 ± 0.3]	10	45	48	0.70	50
3.9	10 %	0.043 ± 0.012 [1.10 ± 0.3]	10	45	44	0.80	50
4.7	10 %	0.043 ± 0.012 [1.10 ± 0.3]	10	45	41	0.90	50
5.6	10 %	0.043 ± 0.012 [1.10 ± 0.3]	4	45	37	0.70	25
6.8	10 %	0.043 ± 0.012 [1.10 ± 0.3]	4	45	34	0.80	25
8.2	10 %	0.043 ± 0.012 [1.10 ± 0.3]	4	45	30	0.90	25
10	10 %	0.043 ± 0.012 [1.10 ± 0.3]	2	45	28	1.00	25
12	10 %	0.043 ± 0.012 [1.10 ± 0.3]	2	45	26	1.05	15
15	10 %	0.043 ± 0.012 [1.10 ± 0.3]	1	45	22	0.70	5
18	10 %	0.043 ± 0.012 [1.10 ± 0.3]	1	45	21	0.70	5
22	10 %	0.043 ± 0.012 [1.10 ± 0.3]	1	35	19	0.90	5
27	10 %	0.043 ± 0.012 [1.10 ± 0.3]	1	35	17	0.90	5
33	10 %	0.043 ± 0.012 [1.10 ± 0.3]	1	35	15	1.05	5

DESCRIPTION

I LSB-1206	3.3 μH	± 10 %	ER	e3
MODEL	INDUCTANCE VALUE	INDUCTANCE TOLERANCE	PACKAGE CODE	JEDEC LEAD (Pb)-FREE STANDARD

GLOBAL PART NUMBER

I	L	S	B	1	2	0	6	E	R	3	R	3	K
PRODUCT FAMILY				SIZE				PACKAGE CODE		INDUCTANCE VALUE			TOL.

DIMENSIONS in inches [millimeters]

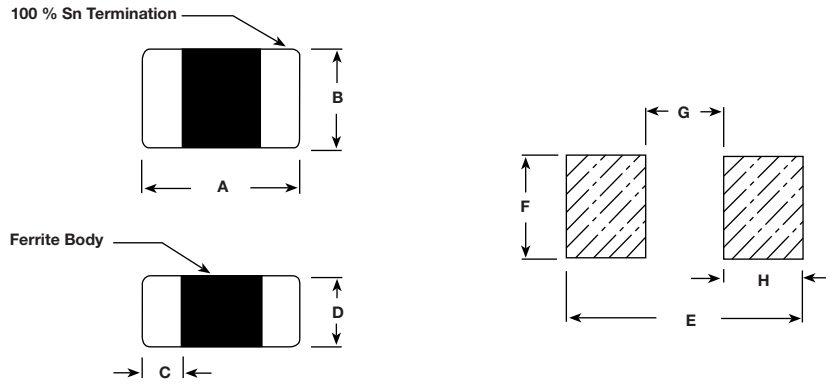

Dimensional Outline

Suggested Pad Layout

A	B	C	D	E	F	G	H
0.126 ± 0.008 [3.2 ± 0.2]	0.063 ± 0.008 [1.6 ± 0.2]	0.020 ± 0.012 [0.5 ± 0.3]	0.043 ± 0.012 [1.10 ± 0.3]	0.185 [4.7]	0.070 [1.8]	0.087 [2.2]	0.047 [1.2]

TAPE AND REEL SPECIFICATIONS 1206 SIE PER EIA-481-1 in inches [millimeters]

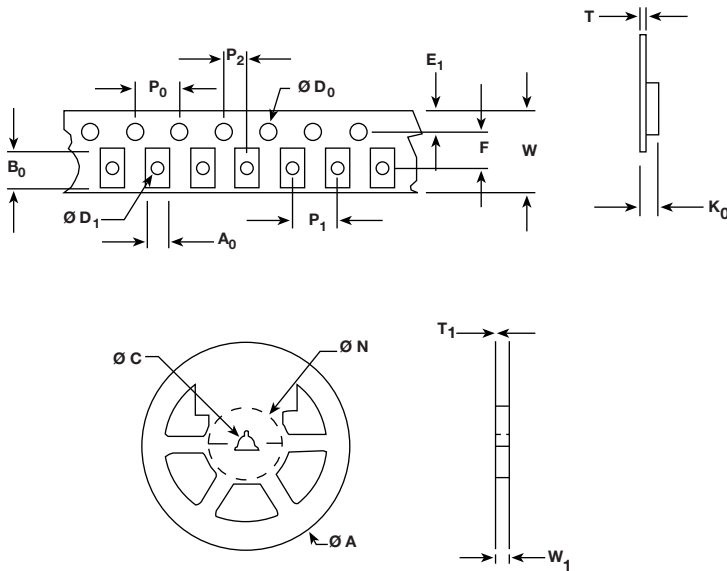

A ₀	0.073 ± 0.004 [1.85 ± 0.1]
B ₀	0.135 ± 0.004 [3.43 ± 0.1]
D ₀	0.059 + 0.005/- 0.000 [1.5 + 0.127]
D ₁	0.039 min. [1.0 min.]
E ₁	0.069 ± 0.004 [1.75 ± 0.1]
F	0.138 ± 0.002 [3.50 ± 0.05]
K ₀	0.048 ± 0.002 [1.22 ± 0.05]
P ₀	0.157 ± 0.004 [4.00 ± 0.1]
P ₁	0.157 ± 0.004 [4.00 ± 0.1]
P ₂	0.079 ± 0.002 [2.00 ± 0.05]
W	0.327 max. [8.3 max.]
T	0.008 ± 0.002 [0.2 ± 0.05]
A	7.000 ± 0.079 [178 ± 2.0]
N	2.500 [63.5]
C	0.512 ± 0.020 [13.00 ± 0.50]
W ₁	0.315 + 0.059/- 0.000 [8.00 + 1.5]
T ₁	0.079 ± 0.002 [2.00 ± 0.05]

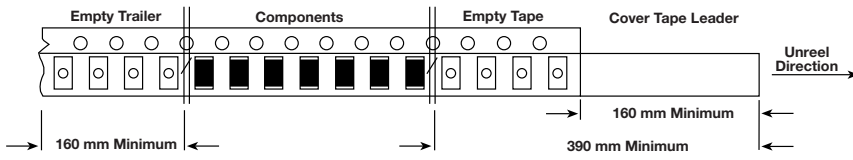

Multilayer Ferrite Beads

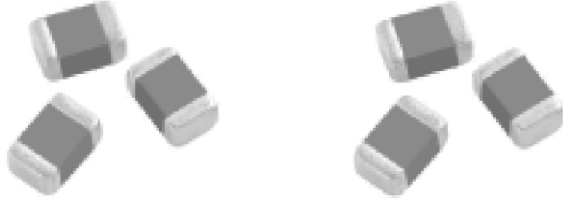

MECHANICAL SPECIFICATIONS

Solderability: 90 % coverage after 5 s dip in 235 °C solder following 60 s preheat at 120 °C to 150 °C and type R flux dip

Resistance to Solder Heat: 10 s in 260 °C solder, after preheat and flux per above

Terminal Strength: 0.2 kg (0.44 lbs) minimum for 30 s

Beam Strength: 0.2 kg (0.44 lbs) minimum

Flex: 0.2 mm minimum mounted on a 1.6 mm thick PC board

FEATURES

- High reliability
- Surface mountable
- Magnetically self shielded
- Nickel barrier plating virtually eliminates silver migration
- Compliant to RoHS Directive 2002/95/EC
- Halogen-free according to IEC 61249-2-21 definition



RoHS
COMPLIANT
HALOGEN
FREE

ENVIRONMENTAL SPECIFICATIONS

Operating Temperature: - 55 °C to + 125 °C

Thermal Shock: 100 cycles, - 40 °C to + 125 °C

Biased Humidity: 85 % RH at 85 °C, 1000 h at full rated current

STANDARD ELECTRICAL SPECIFICATIONS		
Z ± 25 % AT 100 MHz (Ω)	DCR MAX. (Ω)	RATED DC CURRENT (mA)
20	0.13	300
30	0.20	300
40	0.20	300
60	0.30	300
70	0.30	300
120	0.45	300
240	0.70	200
300	0.80	200
600	1.00	200

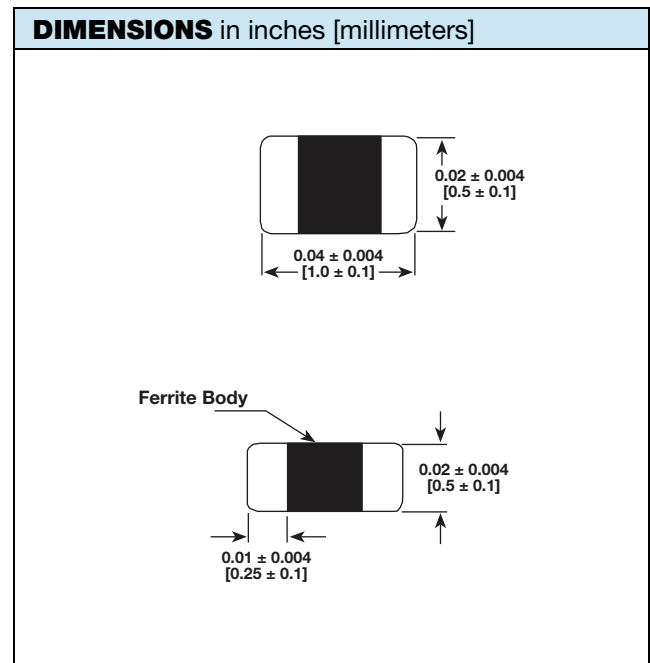

DESCRIPTION				
ILBB-0402	120	± 25 %	ER	e3
MODEL	IMPEDANCE VALUE	IMPEDANCE TOLERANCE	PACKAGE CODE	JEDEC LEAD (Pb)-FREE STANDARD

GLOBAL PART NUMBER													
I	L	B	B	0	4	0	2	E	R	1	2	1	V
PRODUCT FAMILY				SIZE				PACKAGE CODE		IMPEDANCE VALUE			IMPEDANCE TOLERANCE

TYPICAL CURVES - Frequency Characteristics of R, X, and Z

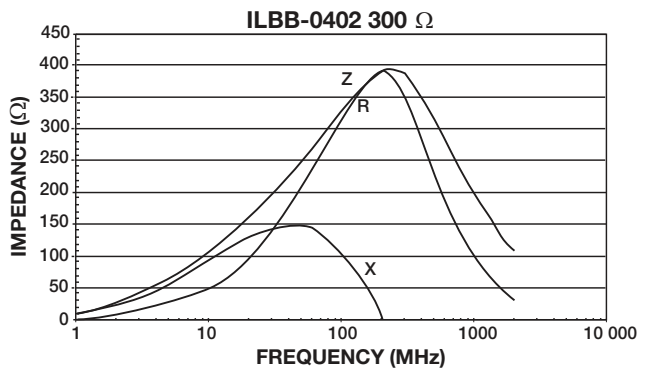
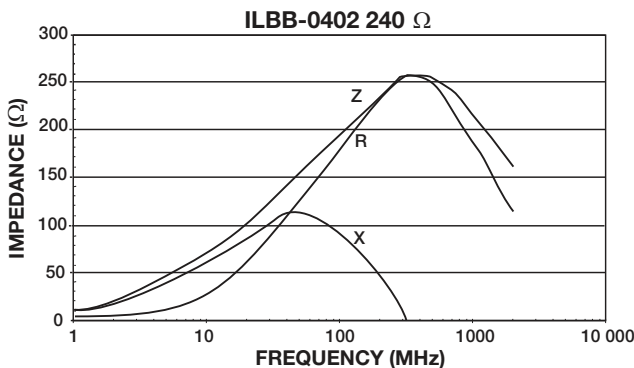
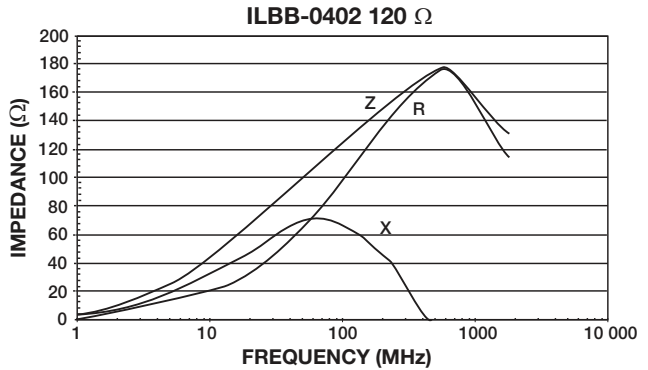
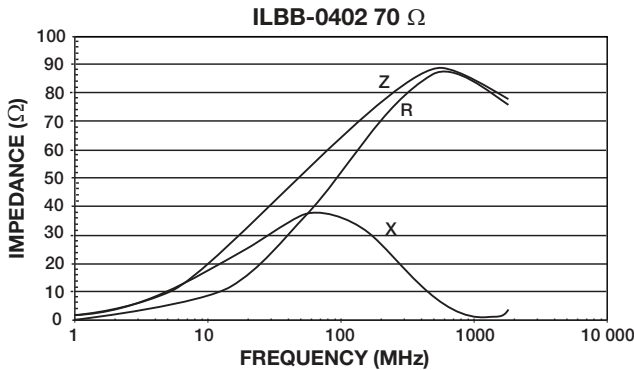
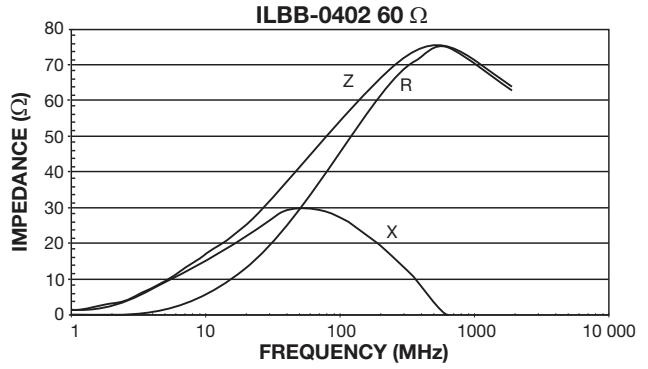
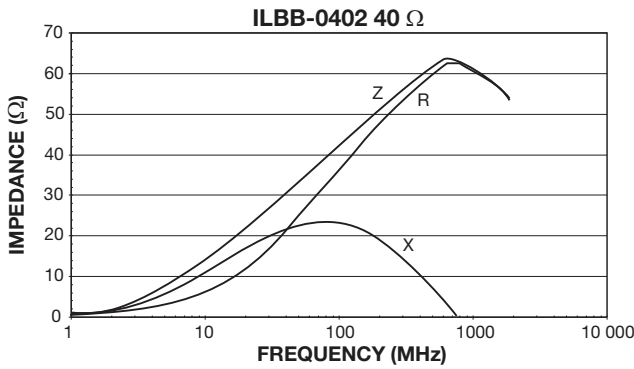
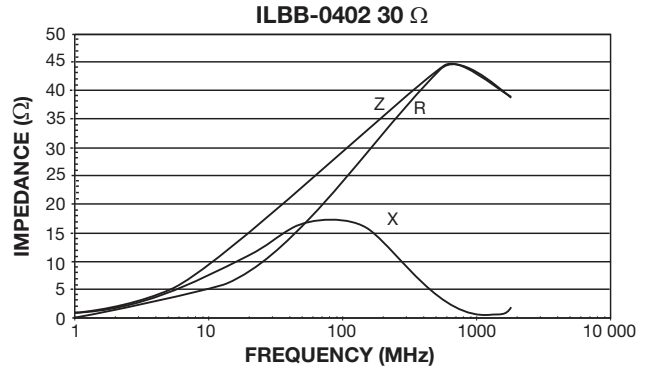
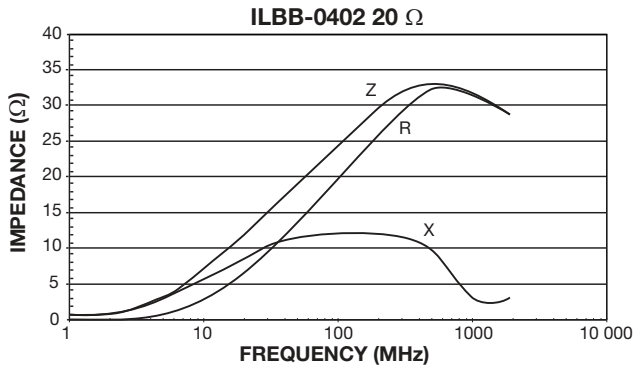

TYPICAL CURVES - Frequency Characteristics of R, X, and Z

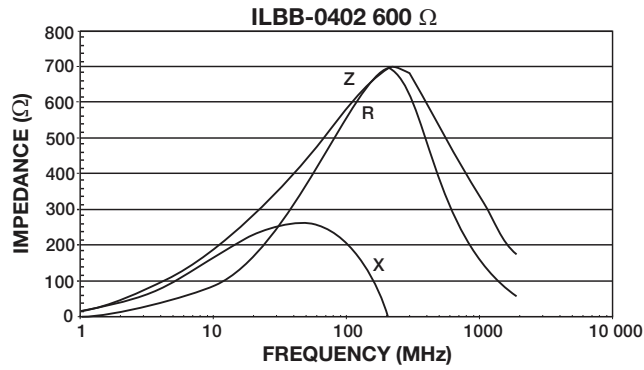

Multilayer Ferrite Beads

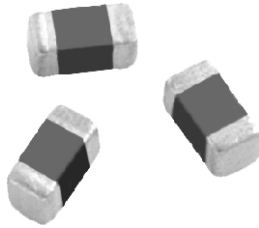

MECHANICAL SPECIFICATIONS

Solderability: 90 % coverage after 5 s dip in 235 °C solder following 60 s preheat at 120 °C to 150 °C and type R flux dip

Resistance to Solder Heat: 10 s in 260 °C solder, after preheat and flux per above

Terminal Strength: 0.3 kg (0.66 lbs) minimum for 30 s

Beam Strength: 0.3 kg (0.66 lbs) minimum

STANDARD ELECTRICAL SPECIFICATIONS		
Z ± 25 % AT 100 MHz (Ω)	DCR MAX. (Ω)	RATED DC CURRENT (mA)
10	0.05	500
30	0.09	500
40	0.10	400
60	0.10	400
68	0.10	200
80	0.20	150
120	0.20	150
150	0.30	150
180	0.30	150
220	0.30	150
300	0.35	150
420	0.40	150
450	0.40	100
600	0.45	100
750	0.60	100
1000	0.60	100
1500	0.70	50
2000	0.80	50

FEATURES

- High reliability
- Surface mountable
- Magnetically self shielded
- Nickel barrier plating virtually eliminates silver migration
- Compliant to RoHS Directive 2002/95/EC
- Halogen-free according to IEC 61249-2-21 definition



RoHS
COMPLIANT
HALOGEN
FREE

ENVIRONMENTAL SPECIFICATIONS

Operating Temperature: - 55 °C to + 125 °C

Thermal Shock: 100 cycles, - 40 °C to + 125 °C

Biased Humidity: 85 % RH at 85 °C, 1000 h at full rated current

DIMENSIONS in inches [millimeters]

Dimensional Outline

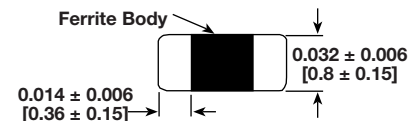
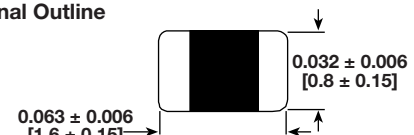

Recommended Pad Layout

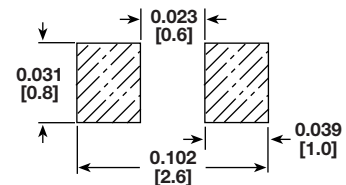

PACKAGING OPTIONS

- Tape and Reel: Embossed plastic carrier tape per EIA481-1, 4000 pieces on a 7" [178 mm] reel

DESCRIPTION

ILBB-0603	30	± 25 %	ER	e3
MODEL	IMPEDANCE VALUE	IMPEDANCE TOLERANCE	PACKAGE CODE	JEDEC LEAD (Pb)-FREE STANDARD

GLOBAL PART NUMBER

I	L	B	B	0	6	0	3	E	R	3	0	0	V
PRODUCT FAMILY				SIZE				PACKAGE CODE		IMPEDANCE VALUE			IMPEDANCE TOLERANCE

TAPE AND REEL SPECIFICATIONS 0603 SIZE PER EIA-481-1 in inches [millimeters]

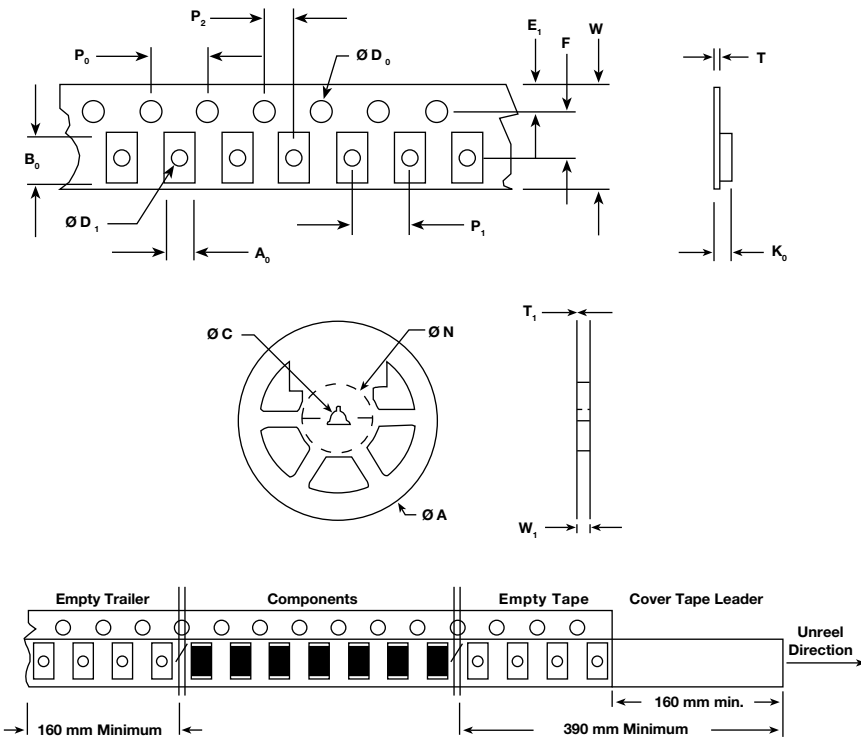

A ₀	0.045 ± 0.004 [1.14 ± 0.1]
B ₀	0.071 ± 0.008 [1.80 ± 0.2]
D ₀	0.059 + 0.004/- 0.000 [1.5 + 0.1/- 0.0]
D ₁	0.039 min. [1.0 min.]
E ₁	0.069 ± 0.004 [1.75 ± 0.1]
F	0.138 ± 0.002 [3.50 ± 0.05]
K ₀	0.045 ± 0.002 [1.15 ± 0.05]
P ₀	0.157 ± 0.004 [4.00 ± 0.1]
P ₁	0.157 ± 0.004 [4.00 ± 0.1]
P ₂	0.079 ± 0.002 [2.00 ± 0.05]
W	0.327 max. [8.3 max.]
T	0.008 ± 0.002 [0.2 ± 0.05]
A	7.000 ± 0.079 [178 ± 2.0]
N	2.500 [63.5] min.
C	0.51 ± 0.020/- 0.008 [13.00 ± 0.5/- 0.5]
W ₁	0.315 + 0.059/- 0.000 [8.00 + 1.5/- 0.0]
T ₁	0.079 ± 0.002 [2.00 ± 0.05]

TYPICAL CURVES - Frequency Characteristics of R, X, and Z

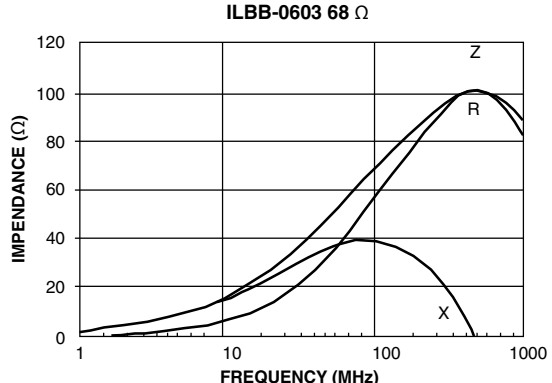
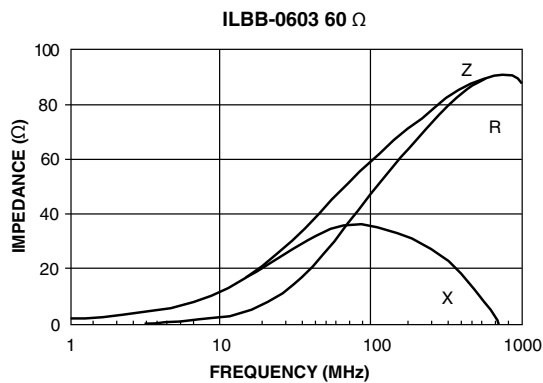
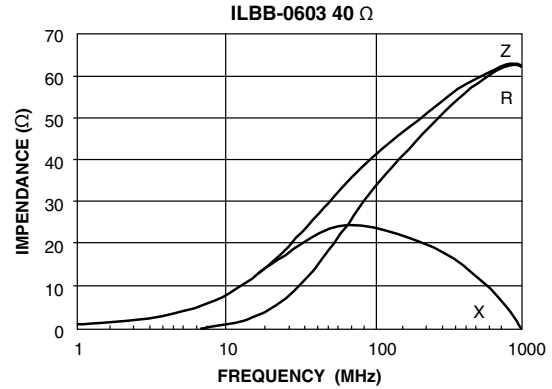
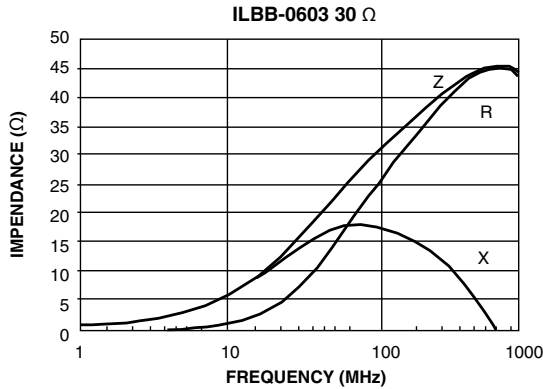

TYPICAL CURVES - Frequency Characteristics of R, X, and Z

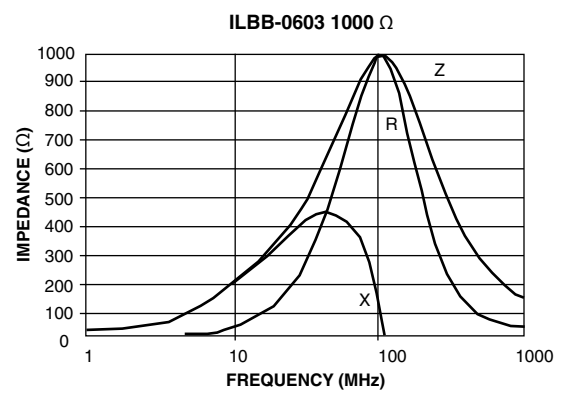
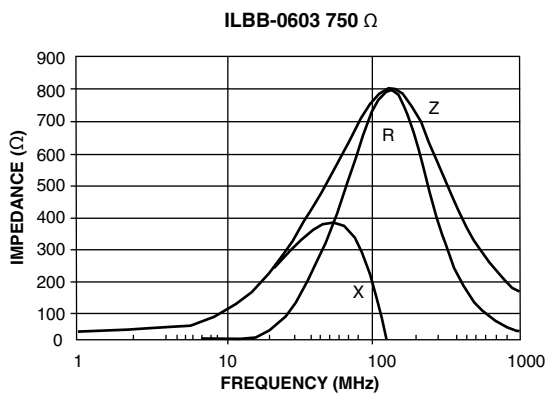
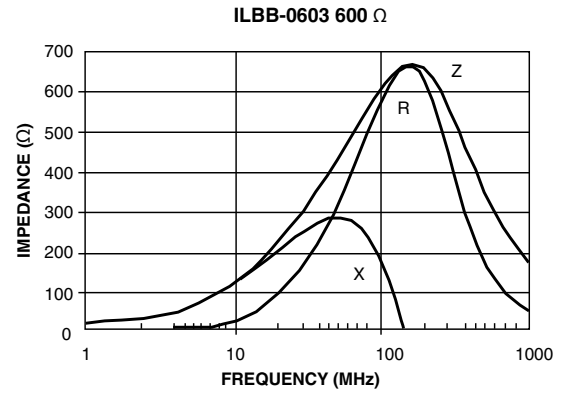
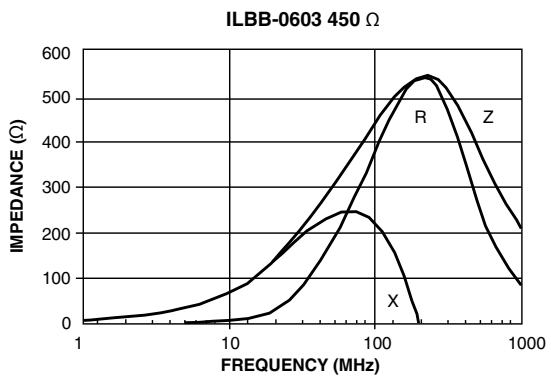
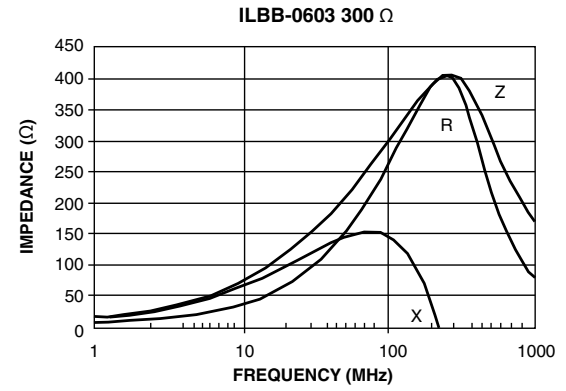
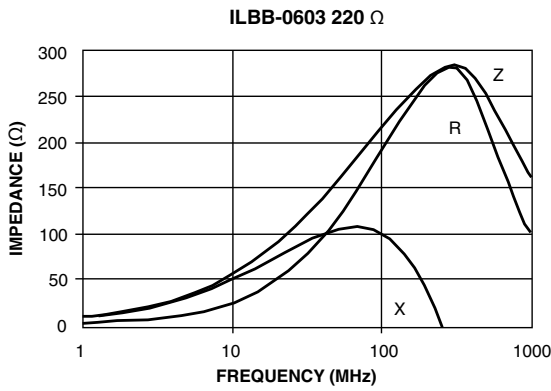
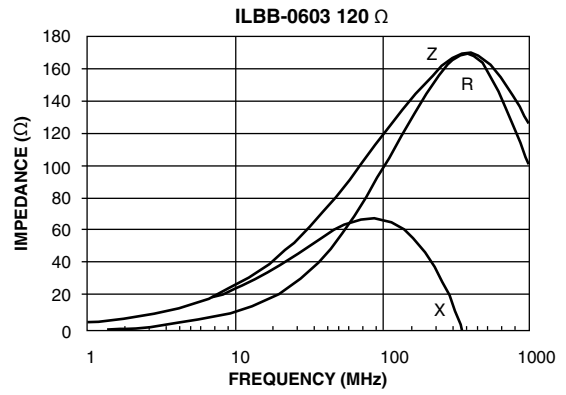
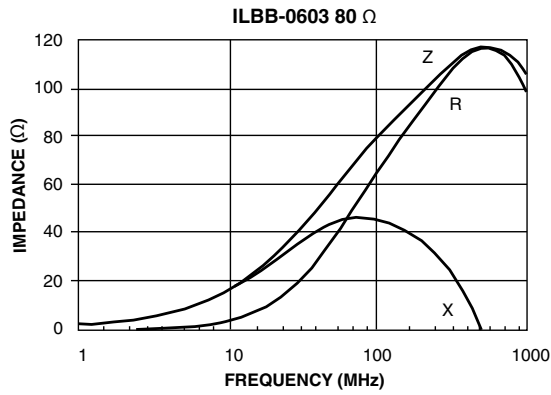

Multilayer Ferrite Beads

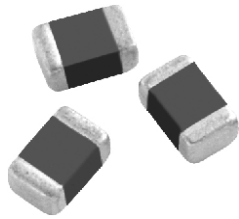

MECHANICAL SPECIFICATIONS

Solderability: 90 % coverage after 5 s dip in 235 °C solder following 60 s preheat at 120 °C to 150 °C and type R flux dip

Resistance to Solder Heat: 10 s in 260 °C solder, after preheat and flux per above

Terminal Strength: 0.6 kg (1.32 lbs) minimum for 30 s

Beam Strength: 1 kg (2.2 lbs) minimum

Flex: 0.079" [2 mm] min. mounted on 0.063" [1.6 mm] thick PC board

FEATURES

- High reliability
- Surface mountable
- Magnetically self shielded
- Nickel barrier plating virtually eliminates silver migration
- Compliant to RoHS Directive 2002/95/EC
- Halogen-free according to IEC 61249-2-21 definition



RoHS
COMPLIANT
HALOGEN
FREE

ENVIRONMENTAL SPECIFICATIONS

Operating Temperature: - 55 °C to + 125 °C

Thermal Shock: 100 cycles, - 40 °C to + 125 °C

Biased Humidity: 85 % RH at 85 °C, 1000 h at full rated current

STANDARD ELECTRICAL SPECIFICATIONS		
Z ± 25 % AT 100 MHz (Ω)	DCR MAX. (Ω)	RATED DC CURRENT (mA)
7	0.06	600
11	0.06	600
17	0.06	600
26	0.06	600
32	0.06	600
40	0.15	300
50	0.15	300
60	0.15	300
75	0.15	300
80	0.15	300
90	0.15	300
100	0.15	300
120	0.15	300
150	0.15	300
180	0.20	200
220	0.20	200
300	0.20	200
400	0.30	200
600	0.30	200
1000	0.35	100
1500	0.40	100
2000	0.50	80
2200	0.60	80

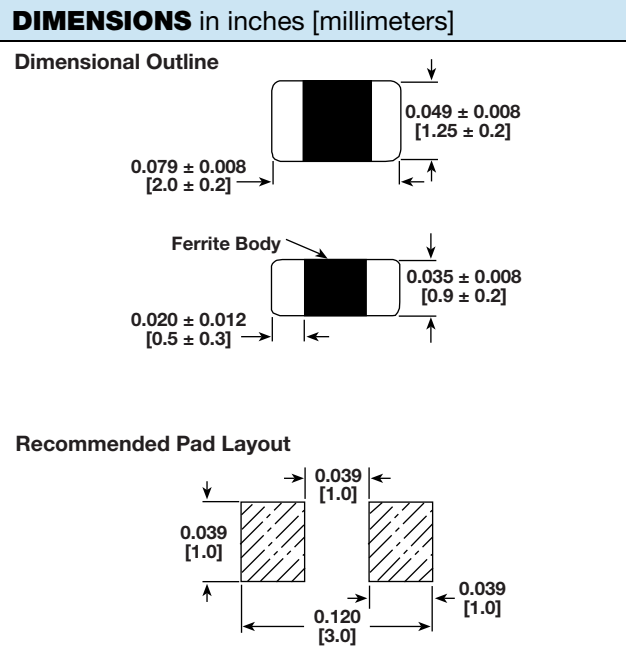

PACKAGING OPTIONS
• Tape and Reel: Embossed plastic carrier tape per EIA481-1, 4000 pieces on a 7" [178 mm] reel

DESCRIPTION				
ILBB-0805	11	± 25 %	ER	e3
MODEL	IMPEDANCE VALUE	IMPEDANCE TOLERANCE	PACKAGE CODE	JEDEC LEAD (Pb)-FREE STANDARD

GLOBAL PART NUMBER				
I	L	B	B	0 8 0 5
PRODUCT FAMILY				SIZE
E	R	1	1	0
PACKAGE CODE		IMPEDANCE VALUE		IMPEDANCE TOLERANCE

TAPE AND REEL SPECIFICATIONS 0805 SIZE PER EIA-481-1 in inches [millimeters]

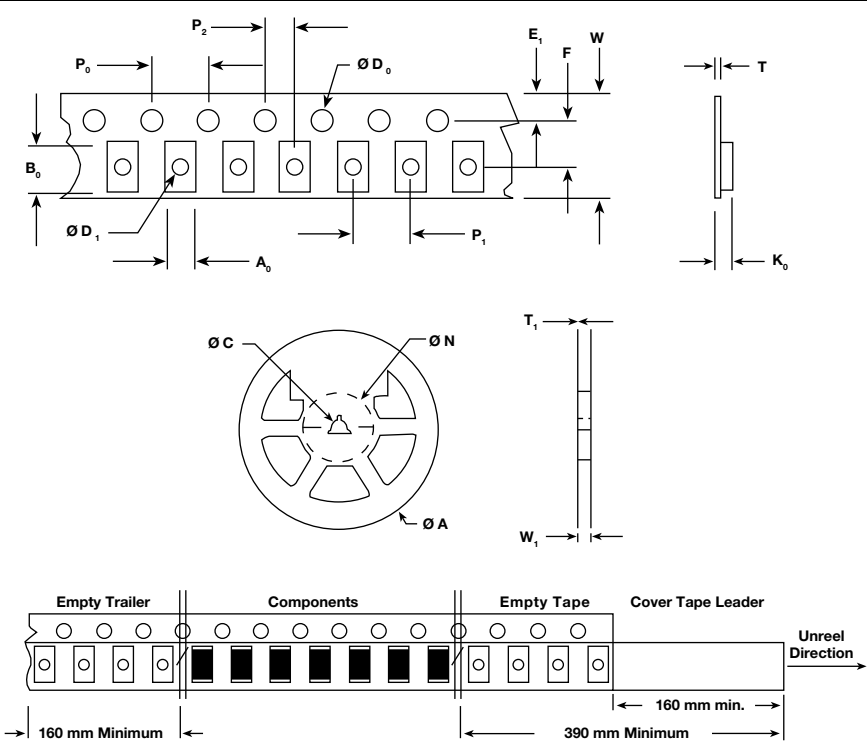

A ₀	0.059 ± 0.004 [1.50 ± 0.1]
B ₀	0.093 ± 0.006 [2.35 ± 0.15]
D ₀	0.059 + 0.004/- 0.000 [1.5 + 0.1/- 0.0]
D ₁	0.039 min. [1.0 min.]
E ₁	0.069 ± 0.004 [1.75 ± 0.1]
F	0.138 ± 0.002 [3.50 ± 0.05]
K ₀	0.049 ± 0.002 [1.24 ± 0.05]
P ₀	0.157 ± 0.004 [4.00 ± 0.1]
P ₁	0.157 ± 0.004 [4.00 ± 0.1]
P ₂	0.079 ± 0.002 [2.00 ± 0.05]
W	0.327 max. [8.3 max.]
T	0.008 ± 0.002 [0.2 ± 0.05]
A	7.000 ± 0.079 [178 ± 2.0]
N	2.500 [63.5]
C	0.512 ± 0.020/- 0.008 [13.00 ± 0.5/- 0.2]
W ₁	0.315 + 0.059/- 0.000 [8.00 + 1.5]
T ₁	0.079 ± 0.002 [2.00 ± 0.05]

TYPICAL CURVES - Frequency Characteristics of R, X, and Z

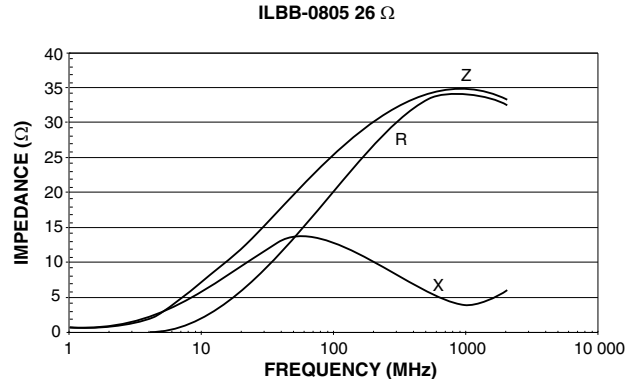
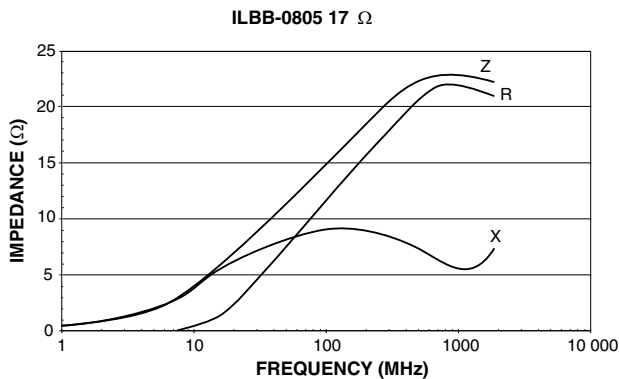
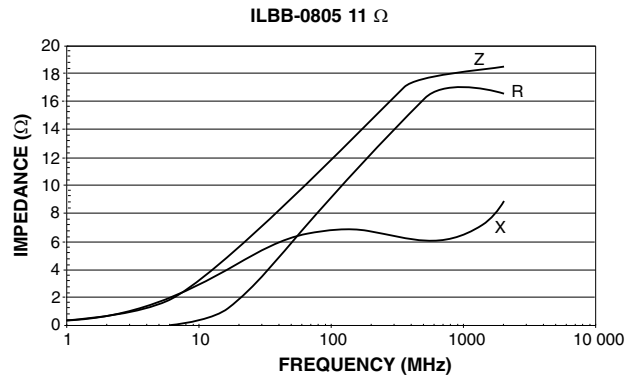
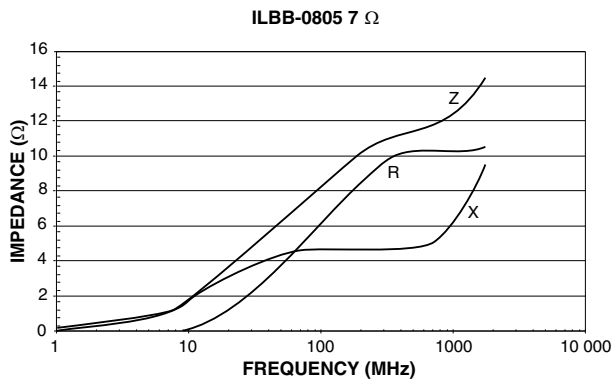



TYPICAL CURVES - Frequency Characteristics of R, X, and Z

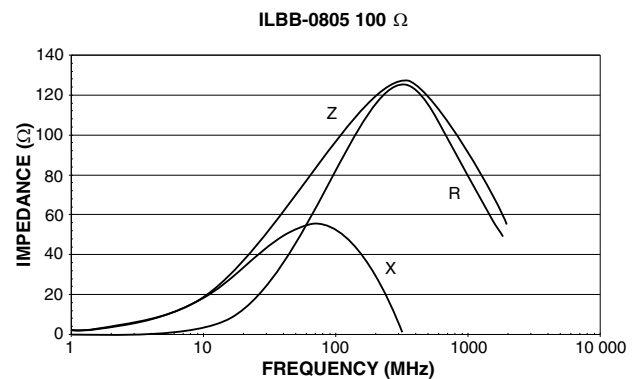
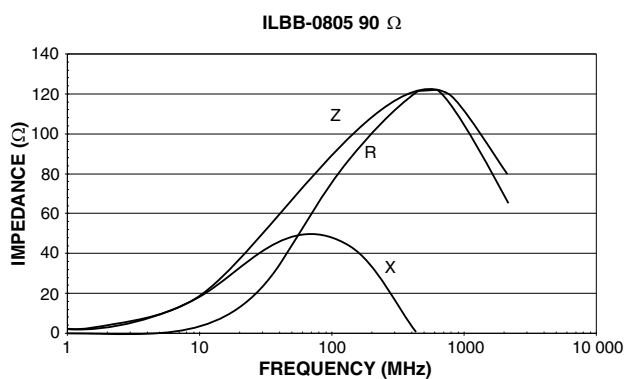
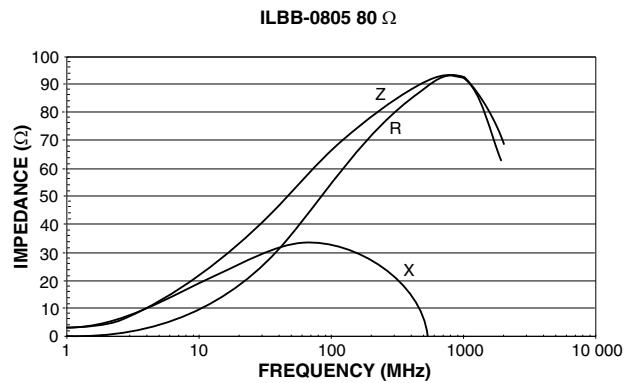
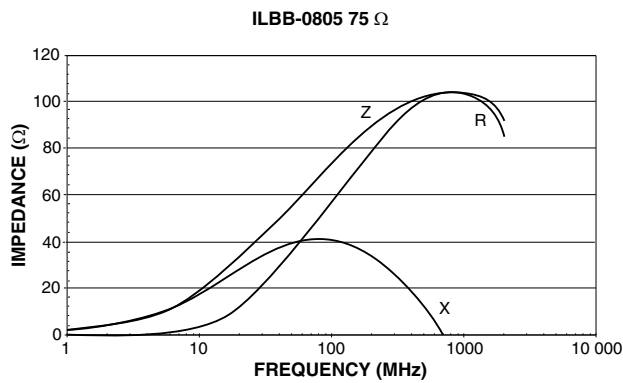
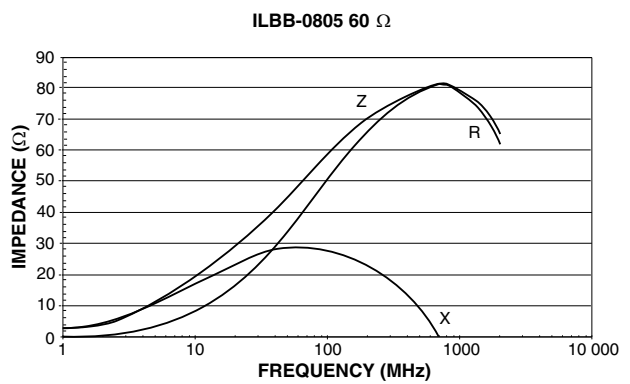
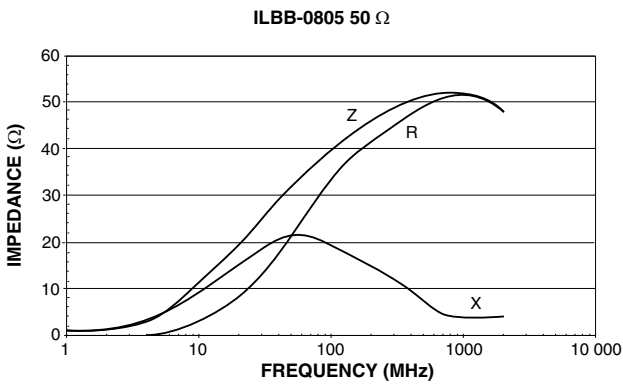
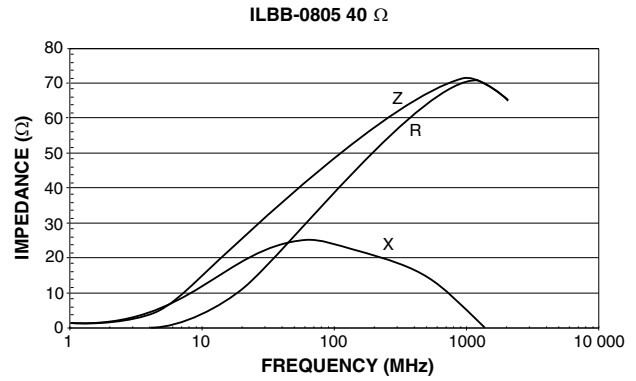
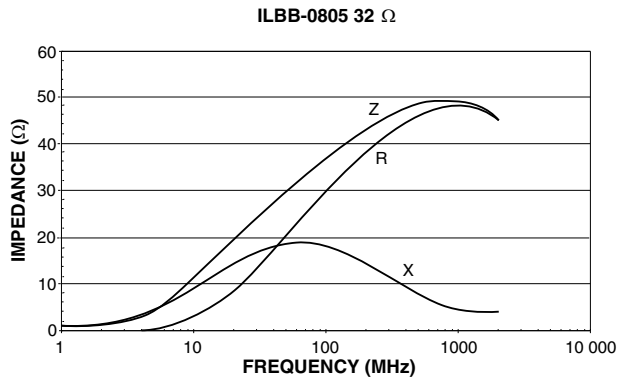



TYPICAL CURVES - Frequency Characteristics of R, X, and Z

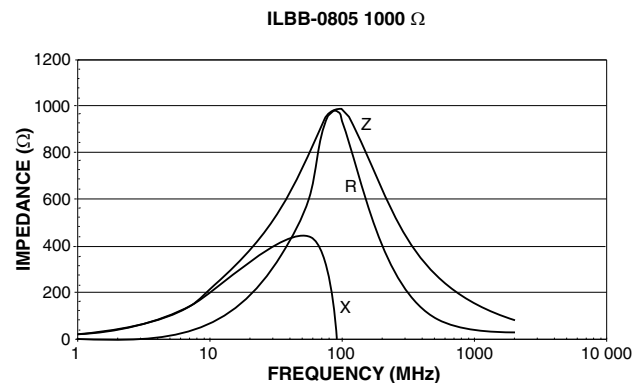
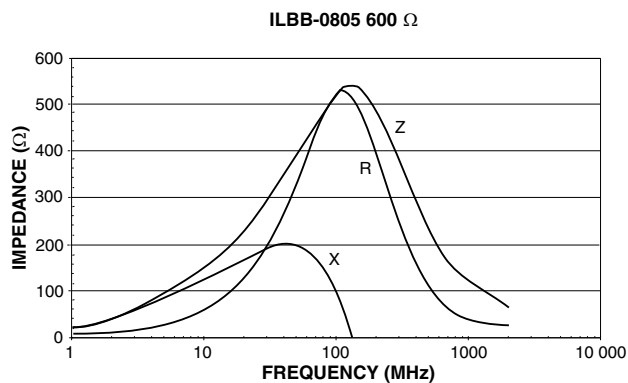
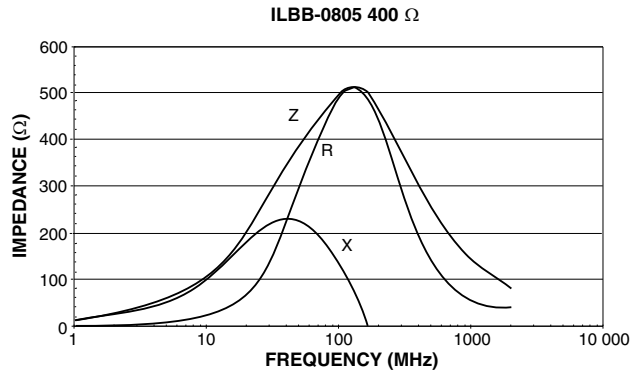
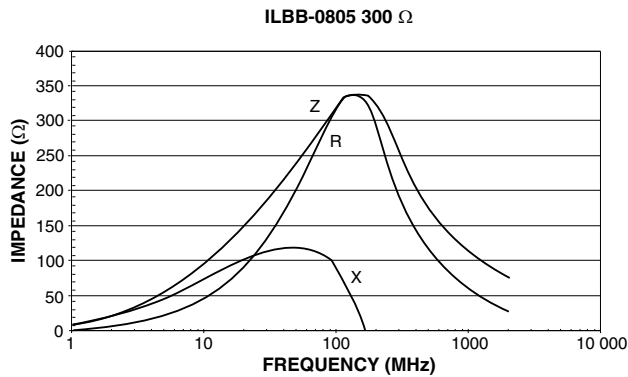
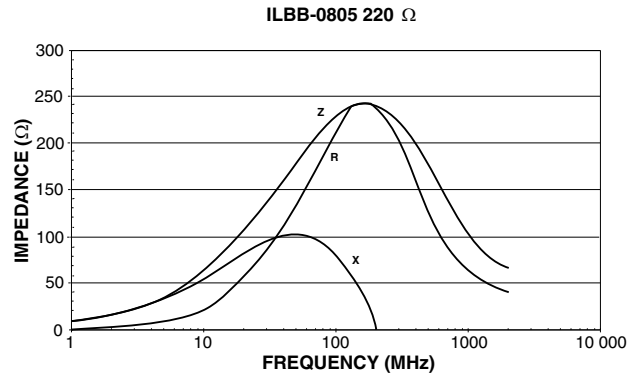
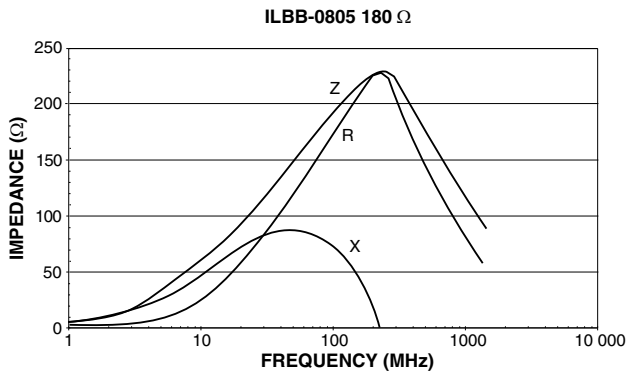
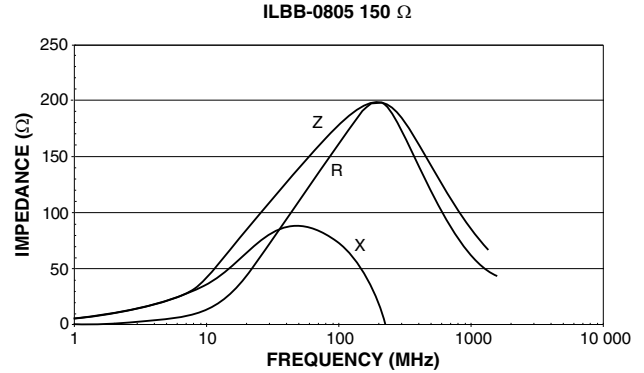
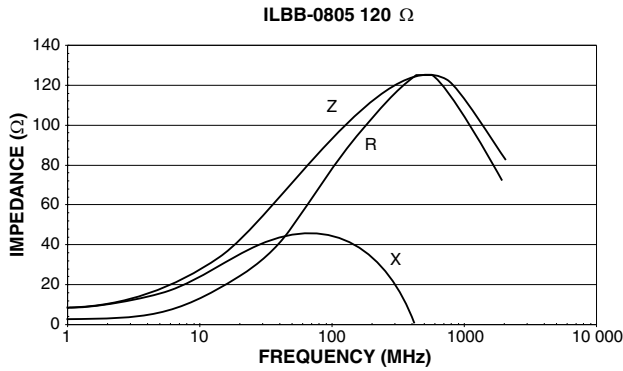



TYPICAL CURVES - Frequency Characteristics of R, X, and Z

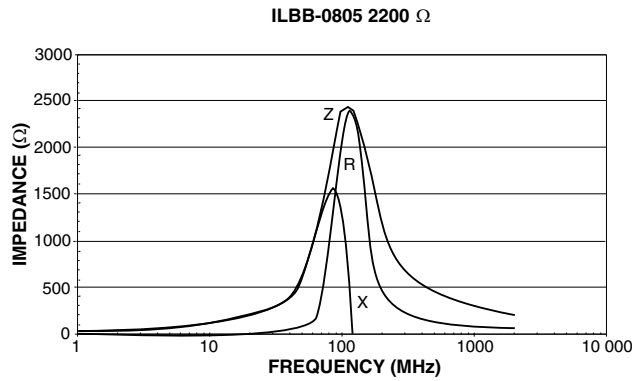
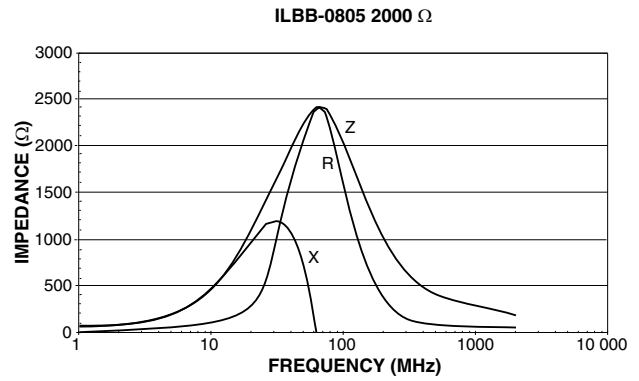
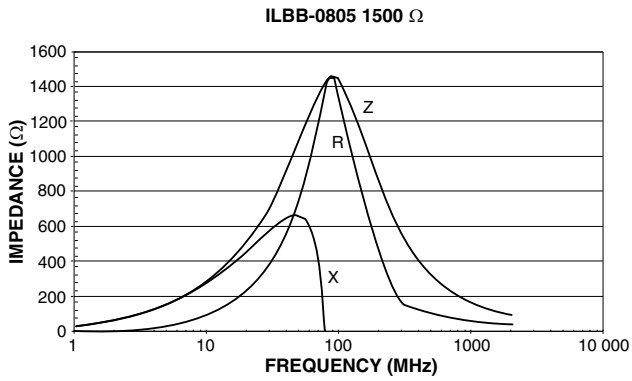

Multilayer Ferrite Beads



MECHANICAL SPECIFICATIONS

Solderability: 90 % coverage after 5 s dip in 235 °C solder following 60 s preheat at 120 °C to 150 °C and type R flux dip

Resistance to Solder Heat: 10 s in 260 °C solder, after preheat and flux per above

Terminal Strength: 1.0 kg (2.2 lbs) minimum for 30 s

Beam Strength: 2.0 kg (4.4 lbs) minimum

STANDARD ELECTRICAL SPECIFICATIONS

Z ± 25 % AT 100 MHz (Ω)	FREQUENCY (MHz)	DCR MAX. (Ω)	RATED DC CURRENT (mA)
19	100	0.05	500
26	100	0.05	500
31	100	0.05	500
50	100	0.10	600
60	100	0.10	600
70	100	0.10	600
80	100	0.20	400
90	100	0.20	400
100	100	0.20	400
120	100	0.20	400
150	100	0.20	300
200	100	0.20	300
300	100	0.30	300
500	100	0.30	200
600	100	0.30	200
800	100	0.30	200
1000	100	0.40	200
1200	100	0.40	100
1500	50	0.50	100
2000	30	0.50	100

FEATURES

- High reliability
- Surface mountable
- Magnetically self shielded
- Nickel barrier plating virtually eliminates silver migration
- Compliant to RoHS Directive 2002/95/EC
- Halogen-free according to IEC 61249-2-21 definition



RoHS
COMPLIANT
HALOGEN
FREE

ENVIRONMENTAL SPECIFICATIONS

Operating Temperature: - 55 °C to + 125 °C

Thermal Shock: 300 cycles, - 40 °C to + 125 °C

Biased Humidity: 85 % RH at 85 °C, 1000 h at full rated current

DIMENSIONS in inches [millimeters]

Dimensional Outline

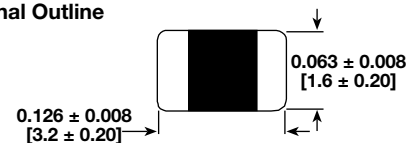

Ferrite Body

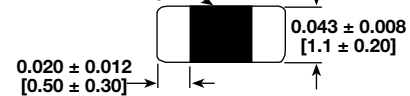

Recommended Pad Layout

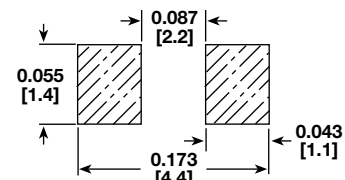

PACKAGING OPTIONS

- Bulk: 1000 pieces per plastic bag
- Tape and Reel: Paper carrier tape, 3000 pieces per reel

DESCRIPTION

ILB-1206	19 Ω	± 25 %	ER	e3
MODEL	IMPEDANCE VALUE	IMPEDANCE TOLERANCE	PACKAGE CODE	JEDEC LEAD (Pb)-FREE STANDARD

GLOBAL PART NUMBER

I	L	B	1	2	0	6	E	R	1	9	0	V
PRODUCT FAMILY			SIZE			PACKAGE CODE		IMPEDANCE VALUE			IMPEDANCE TOLERANCE	

TAPE AND REEL SPECIFICATIONS in inches [millimeters]

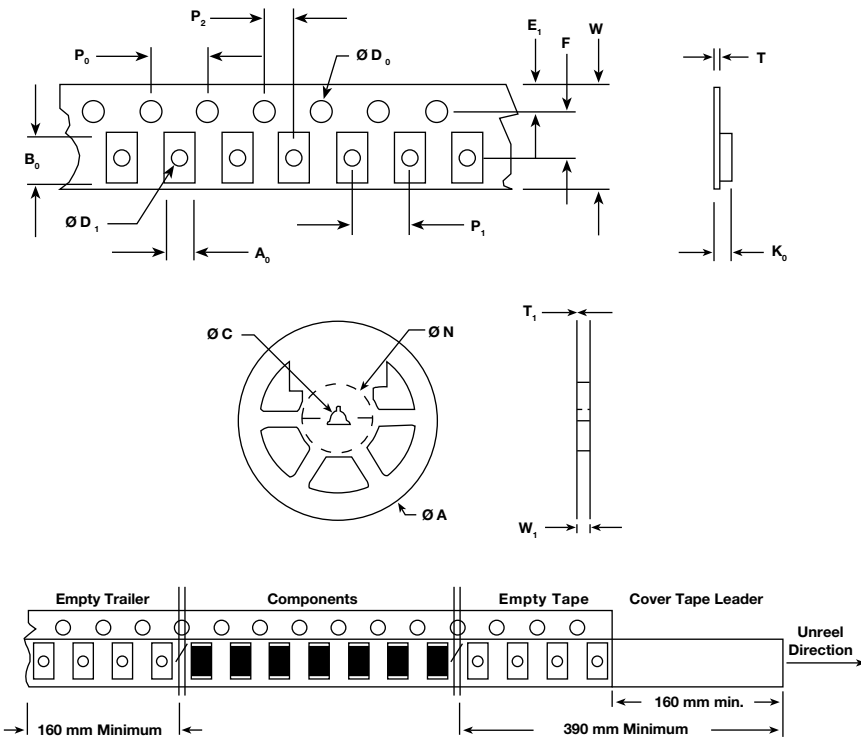

A ₀	0.071 ± 0.008 [1.80 ± 0.2]
B ₀	0.140 ± 0.006 [3.45 ± 0.15]
D ₀	0.059 + 0.005/- 0.000 [1.5 + 0.127/- 0.0]
D ₁	0.039 min. [1.0 min.]
E ₁	0.069 ± 0.004 [1.75 ± 0.1]
F	0.138 ± 0.002 [3.50 ± 0.05]
K ₀	0.049 ± 0.002 [1.24 ± 0.05]
P ₀	0.157 ± 0.004 [4.00 ± 0.1]
P ₁	0.157 ± 0.004 [4.00 ± 0.1]
P ₂	0.079 ± 0.002 [2.00 ± 0.05]
W	0.327 max. [8.3 max.]
T	0.009 ± 0.002 [0.2 ± 0.05]
A	7.000 ± 0.079 [178 ± 2.0]
N	2.500 [63.5]
C	0.512 ± 0.020 [13.00 ± 0.5]
W ₁	0.315 + 0.059/- 0.000 [8.00 + 1.5/- 0.0]
T ₁	0.079 ± 0.002 [2.00 ± 0.05]

TYPICAL CURVES - Frequency Characteristics of R, X, and Z

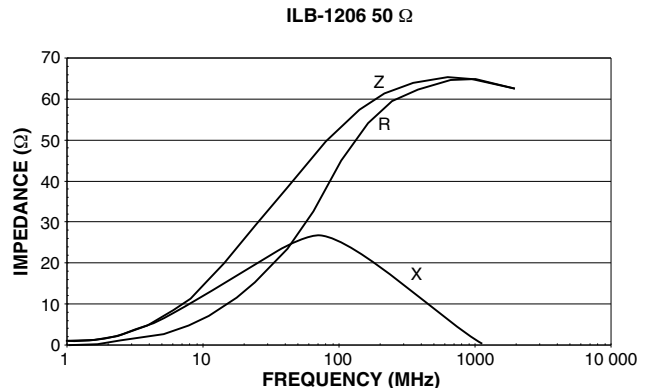
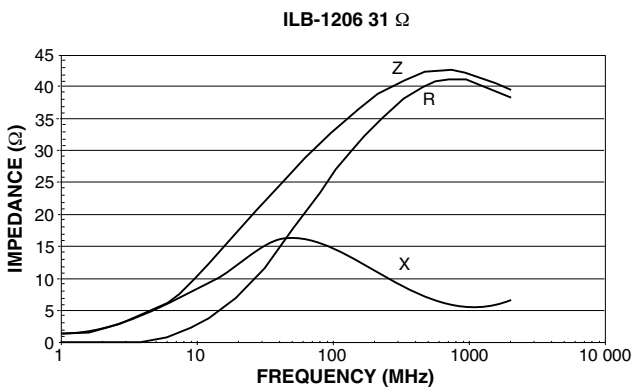
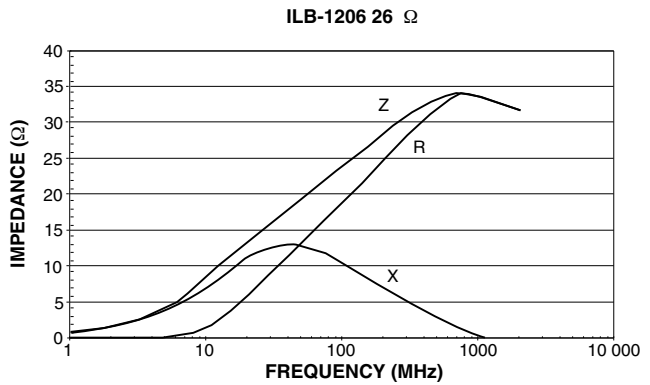
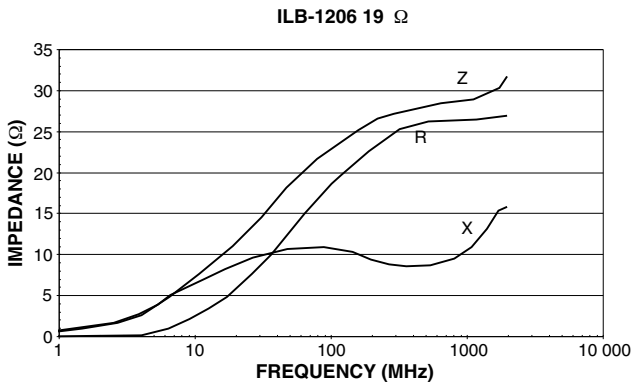

TYPICAL CURVES - Frequency Characteristics of R, X, and Z

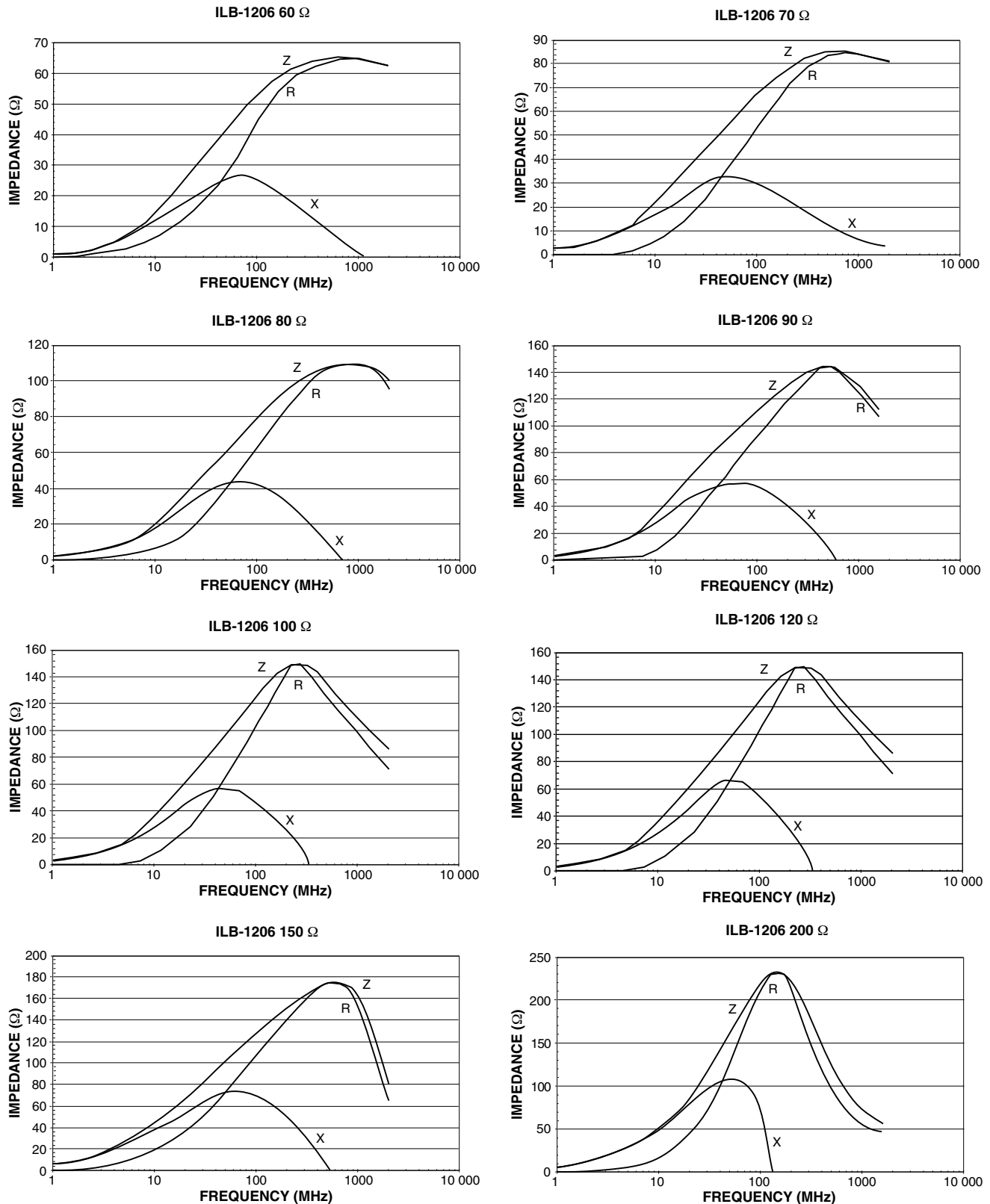

TYPICAL CURVES - Frequency Characteristics of R, X, and Z

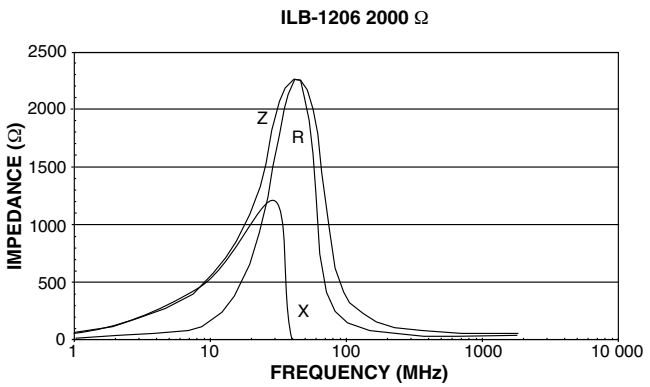
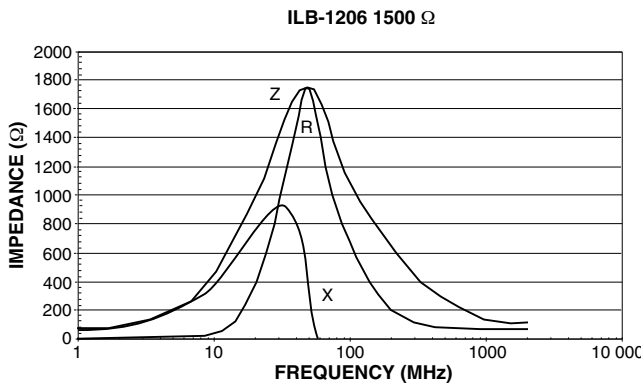
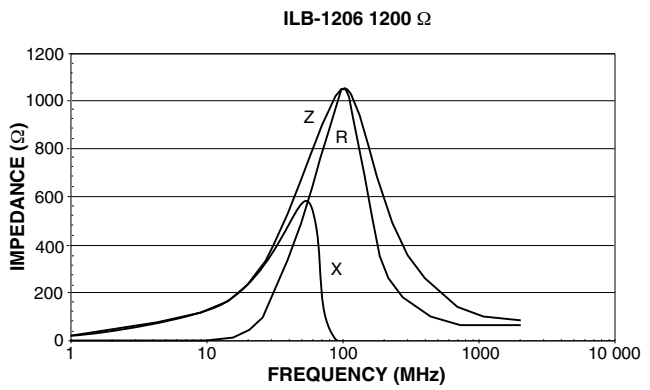
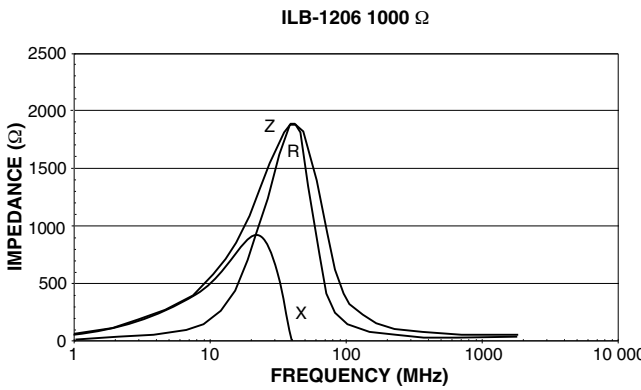
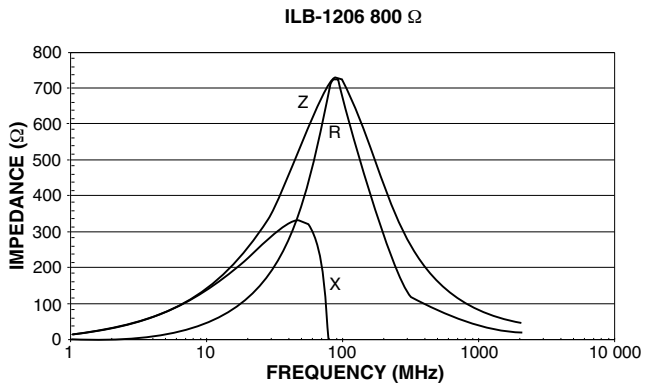
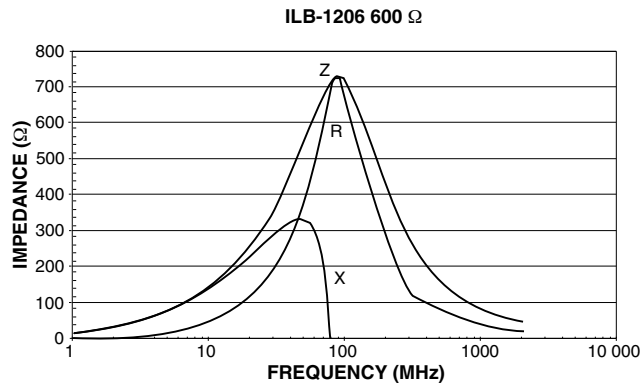
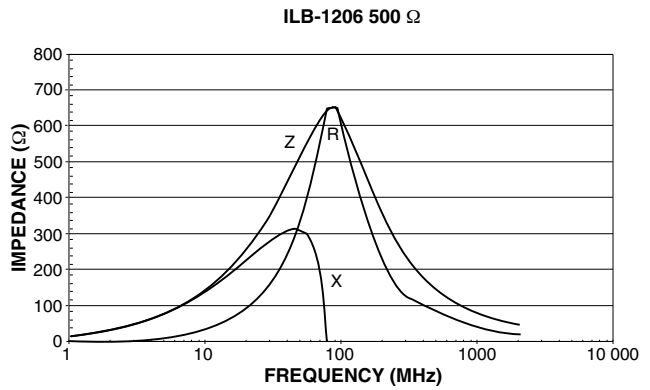
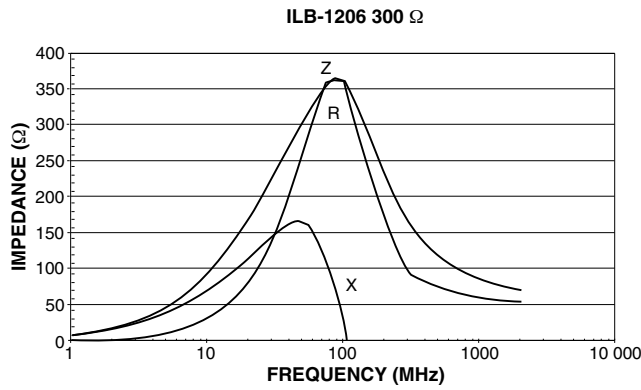

Multilayer Ferrite Beads

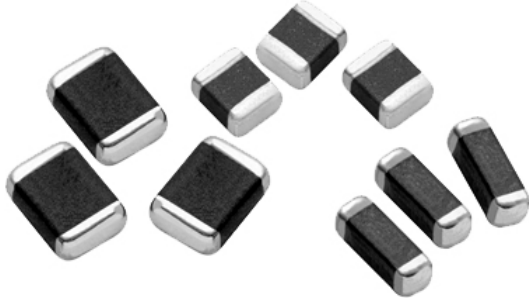

MECHANICAL SPECIFICATIONS

Solderability: 90 % coverage after 5 s dip in 235 °C solder following 60 s preheat at 120 °C to 150 °C and type R flux dip

Resistance to Solder Heat: 10 s in 260 °C solder, after preheat and flux per above

Terminal Strength: 1210: 1.0 kg (2.2 lbs), 1806: 1.0 kg (2.2 lbs), 1812: 1.5 kg (3.3 lbs) for 30 s

Beam Strength: 1210: 2.5 kg (5.5 lbs), 1806: 2.5 kg (5.5 lbs), 1812: 2.5 kg (5.5 lbs)

STANDARD ELECTRICAL SPECIFICATIONS

PART NUMBER	Z ± 25 % AT 100 MHz (Ω)	DCR MAX. (Ω)	RATED DC CURRENT (mA)
ILBB-1210	31	0.30	400
	60	0.30	400
	90	0.30	400
ILBB-1806	80	0.30	400
	100	0.30	300
	150	0.50	200
ILBB-1812	70	0.40	200
	120	0.40	200

FEATURES

- High reliability
- Surface mountable
- Magnetically self shielded
- Nickel barrier plating virtually eliminates silver migration
- Compliant to RoHS Directive 2002/95/EC
- Halogen-free according to IEC 61249-2-21 definition



RoHS
COMPLIANT
HALOGEN
FREE

ENVIRONMENTAL SPECIFICATIONS

Operating Temperature: - 55 °C to + 125 °C

Thermal Shock: 300 cycles, - 40 °C to + 125 °C

Biased Humidity: 85 % RH at 85 °C, 1000 h at full rated current

DIMENSIONS in inches [millimeters]

Dimensional Outline

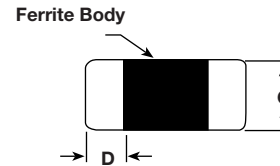
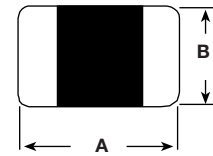

SIZE	A	B	C	D
1210	0.126 ± 0.008 [3.2 ± 0.2]	0.098 ± 0.008 [2.5 ± 0.2]	0.051 ± 0.008 [1.3 ± 0.2]	0.020 ± 0.012 [0.5 ± 0.3]
1806	0.177 ± 0.010 [4.5 ± 0.25]	0.063 ± 0.008 [1.6 ± 0.2]	0.063 ± 0.008 [1.6 ± 0.2]	0.024 ± 0.016 [0.6 ± 0.4]
1812	0.177 ± 0.010 [4.5 ± 0.25]	0.126 ± 0.010 [3.2 ± 0.25]	0.059 ± 0.010 [1.5 ± 0.25]	0.024 ± 0.016 [0.6 ± 0.4]

DESCRIPTION

ILBB	1806	80	± 25 %	ER	e3
MODEL	SIZE	IMPEDANCE VALUE	IMPEDANCE TOLERANCE	PACKAGE CODE	JEDEC LEAD (Pb)-FREE STANDARD

GLOBAL PART NUMBER

I	L	B	B	1	8	0	6	E	R	8	0	0	V
PRODUCT FAMILY				SIZE				PACKAGE CODE		IMPEDANCE VALUE			IMPEDANCE TOLERANCE



TYPICAL CURVES - Frequency Characteristics of R, X, and Z

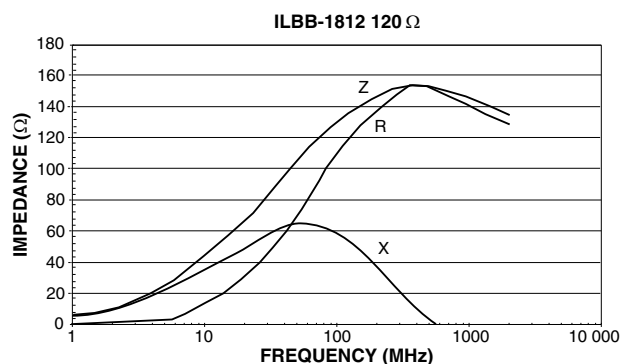
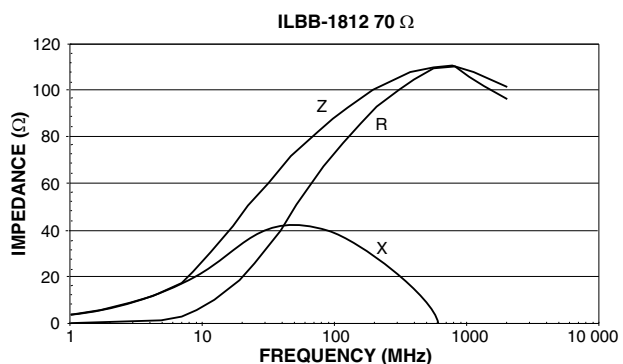
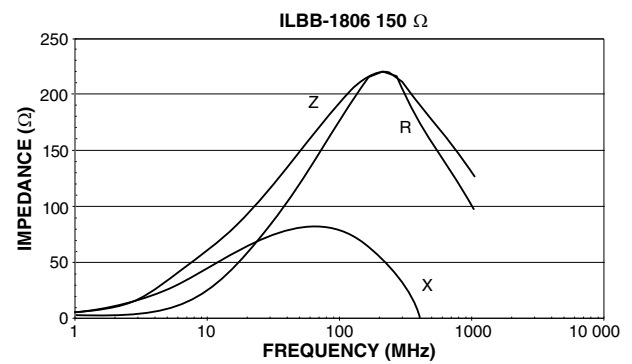
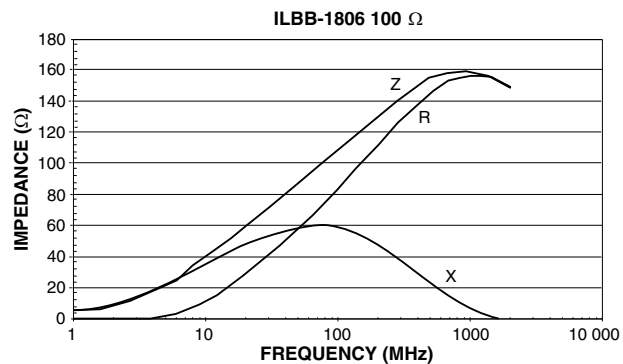
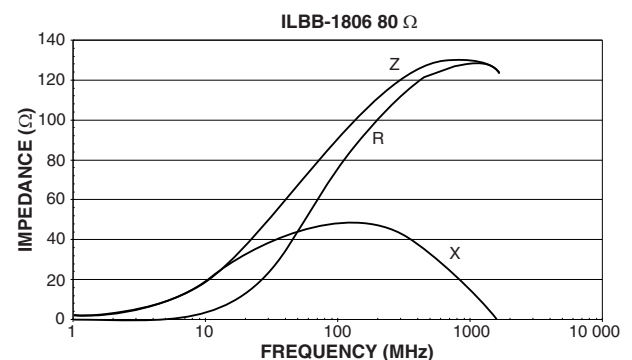
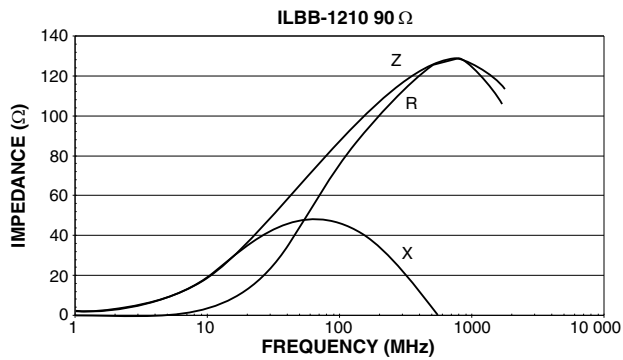
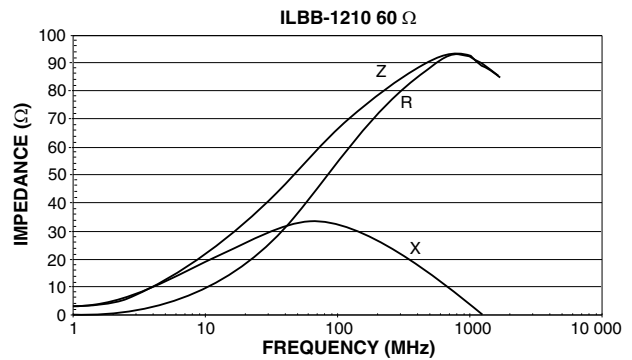
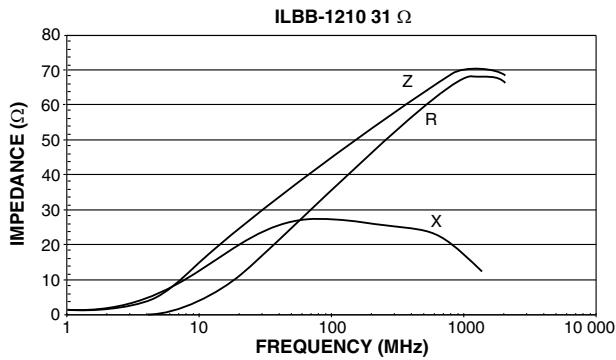

High Current Multilayer Ferrite Beads

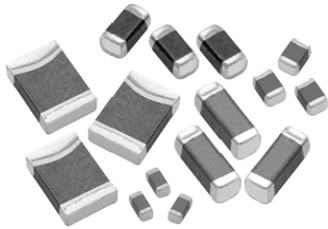

RoHS
COMPLIANT
HALOGEN
FREE

FEATURES

- High reliability
- Surface mountable
- Current rating up to 6 A
- Magnetically self shielded
- Nickel barrier plating virtually eliminates silver migration
- Compliant to RoHS Directive 2002/95/EC
- Halogen-free according to IEC 61249-2-21 definition

MECHANICAL SPECIFICATIONS

Solderability: 90 % coverage after 5 s dip in 235 °C solder following 60 s preheat at 120 °C type R flux dip

Resistance to Solder Heat: 10 s in 260 °C solder, after preheat and flux per above

Terminal Strength: 0603: 0.3 kg (0.66 lbs), 0805: 0.6 kg (1.3 lbs), 1206: 1.0 kg (2.2 lbs), 1806: 1.0 kg (2.2 lbs), 1812: 1.5 kg (3.3 lbs) for 30 s

Beam Strength: 0603: 0.3 kg (0.66 lbs), 0805: 1.0 kg (2.2 lbs), 1206: 2.0 kg (4.4 lbs), 1806: 2.5 kg (5.5 lbs), 1812: 2.5 kg (5.5 lbs)

ENVIRONMENTAL SPECIFICATIONS

Operating Temperature: - 55 °C to + 125 °C

Thermal Shock: 100 cycles, - 40 °C to + 125 °C

Biased Humidity: 85 % RH at 85 °C, 1000 h at full rated current

STANDARD ELECTRICAL SPECIFICATIONS

PART NUMBER	Z ± 25 % (Ω)	TEST FREQUENCY (MHz)	DCR MAX. (Ω)	RATED DC CURRENT (mA)
ILHB-0603	60	100	0.10	2000
	120	100	0.10	2000
ILHB-0805	30	100	0.015	6000
	60	100	0.03	3000
	90	100	0.025	5000
	120	100	0.03	5000
ILHB-1206	250	100	0.04	3000
	600	100	0.10	2000
	50	100	0.02	6000
	75	100	0.03	3000
ILHB-1206	120	100	0.02	6000
	500	100	0.06	2500
	600	100	0.10	2500
ILHB-1806	60	100	0.02	6000
ILHB-1812	120	100	0.02	6000
	600	50	0.04	3000
	1300	60	0.05	3000

DIMENSIONS in inches [millimeters]

Dimensional Outline

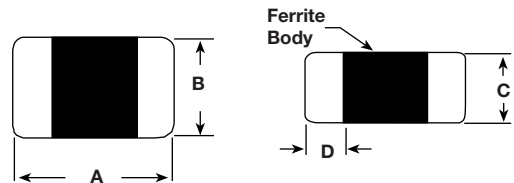

SIZE	A	B	C	D
0603	0.06 ± 0.006 [1.6 ± 0.15]	0.03 ± 0.006 [0.8 ± 0.15]	0.03 ± 0.006 [0.8 ± 0.15]	0.012 ± 0.008 [0.30 ± 0.20]
0805	0.079 ± 0.008 [2.0 ± 0.20]	0.049 ± 0.008 [1.25 ± 0.20]	0.035 ± 0.008 [0.90 ± 0.20]	0.02 ± 0.012 [0.50 ± 0.30]
1206	0.126 ± 0.008 [3.2 ± 0.20]	0.063 ± 0.008 [1.6 ± 0.2]	0.043 ± 0.008 [1.1 ± 0.2]	0.020 ± 0.012 [0.50 ± 0.30]
1806	0.177 ± 0.010 [4.5 ± 0.25]	0.063 ± 0.008 [1.6 ± 0.2]	0.063 ± 0.008 [1.6 ± 0.2]	0.024 ± 0.016 [0.60 ± 0.40]
1812	0.177 ± 0.010 [4.5 ± 0.25]	0.126 ± 0.010 [3.2 ± 0.25]	0.060 ± 0.010 [1.5 ± 0.25]	0.024 ± 0.016 [0.60 ± 0.40]

DESCRIPTION

ILHB	1206	120	± 25 %	ER	e3
MODEL	SIZE	IMPEDANCE VALUE	IMPEDANCE TOLERANCE	PACKAGE CODE	JEDEC LEAD (Pb)-FREE STANDARD

GLOBAL PART NUMBER

I	L	H	B	1	2	0	6	E	R	1	2	1	V
PRODUCT FAMILY				SIZE				PACKAGE CODE		IMPEDANCE VALUE			IMPEDANCE TOLERANCE



TYPICAL CURVES (Frequency Characteristics of R, X, and Z)

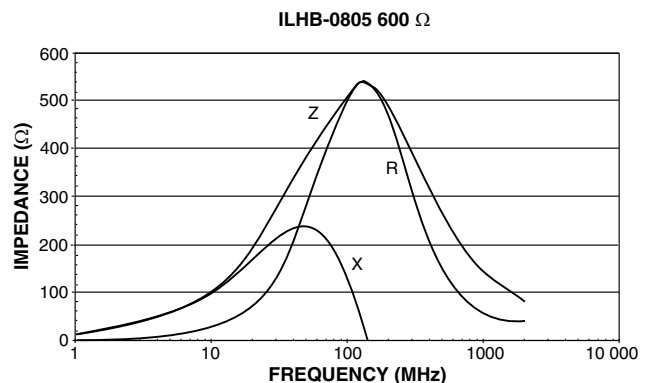
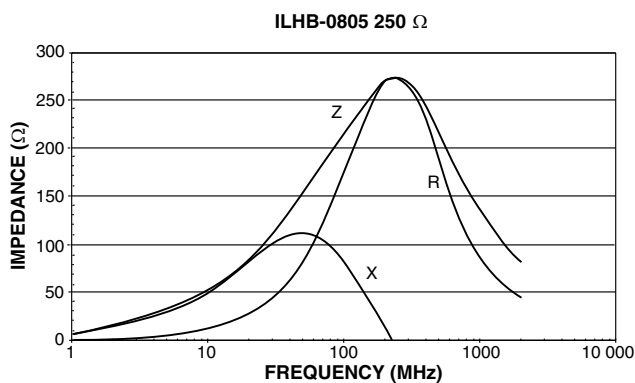
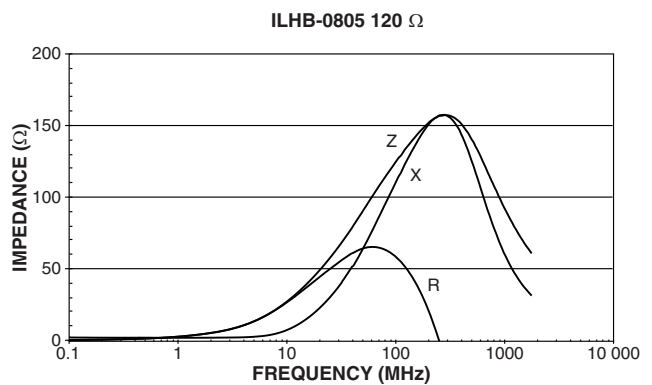
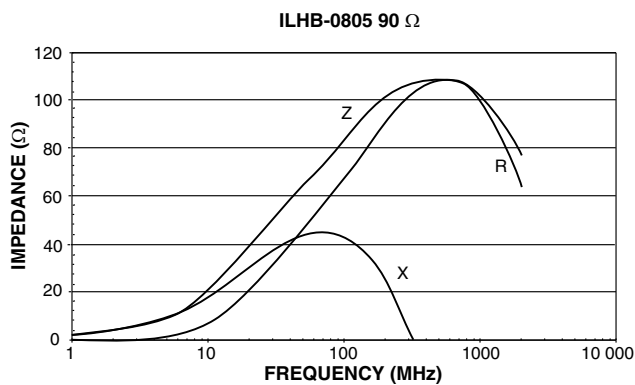
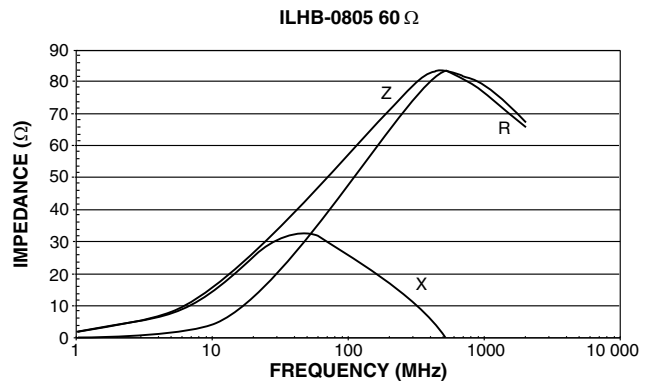
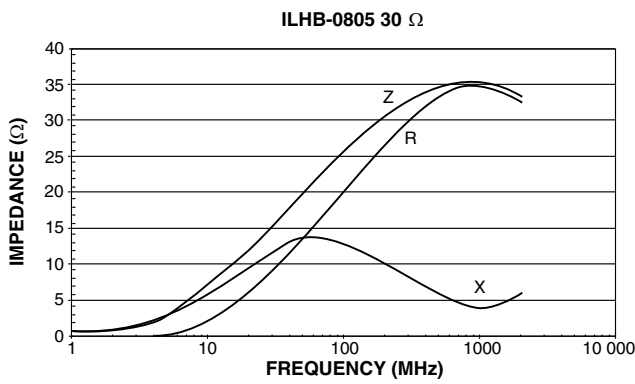
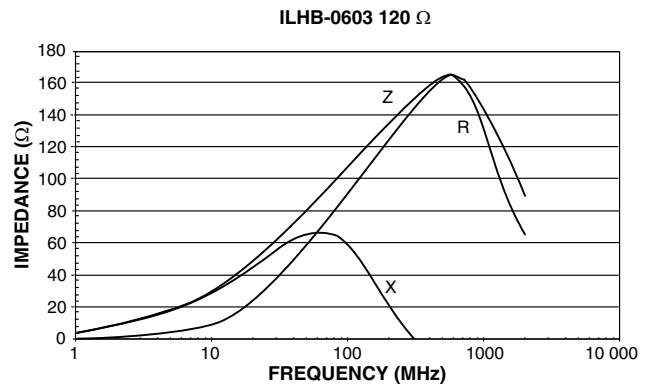
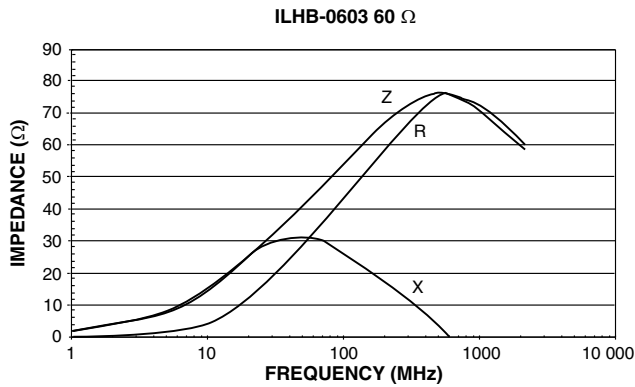

TYPICAL CURVES (Frequency Characteristics of R, X, and Z)

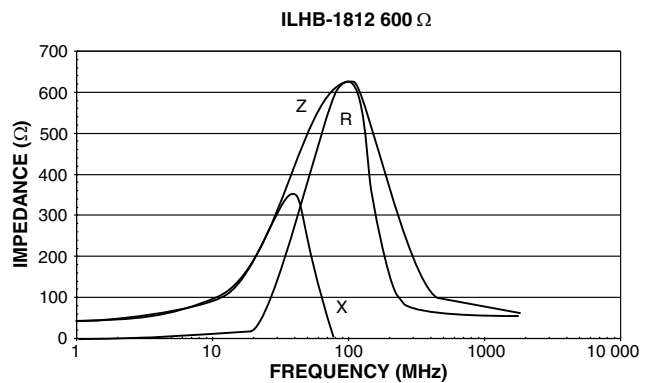
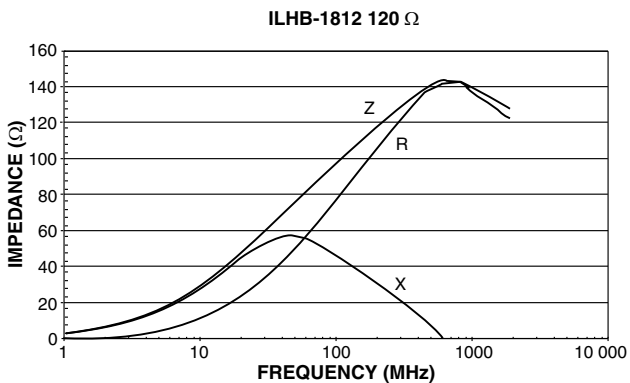
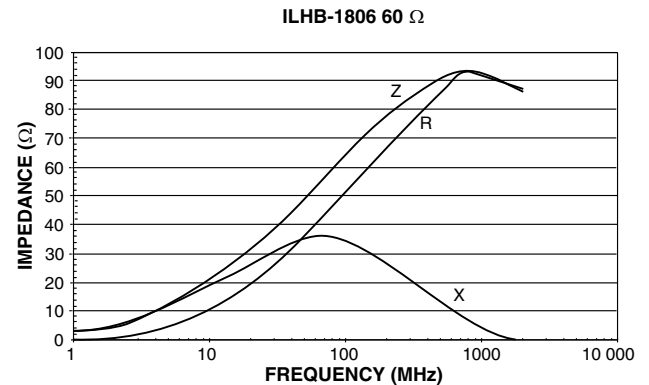
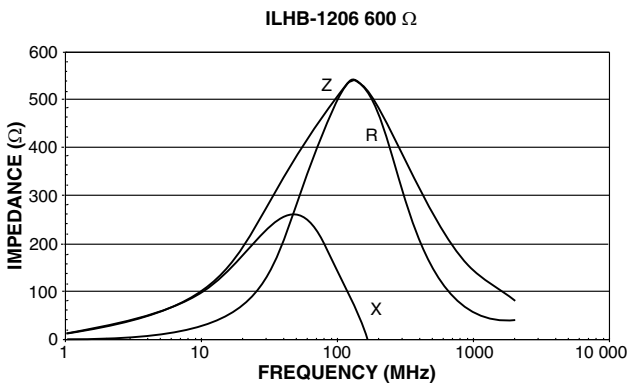
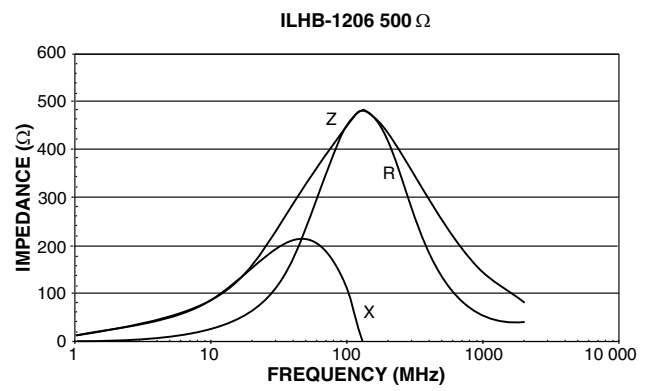
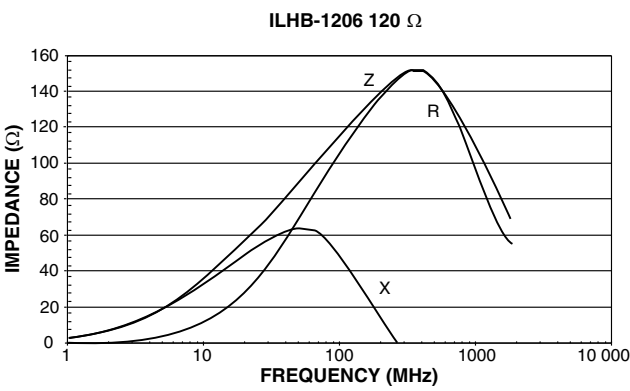
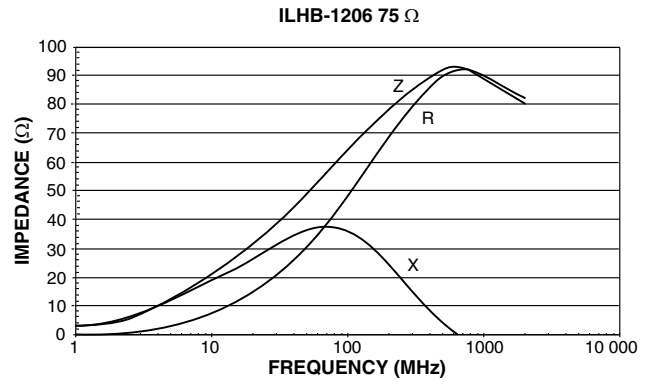
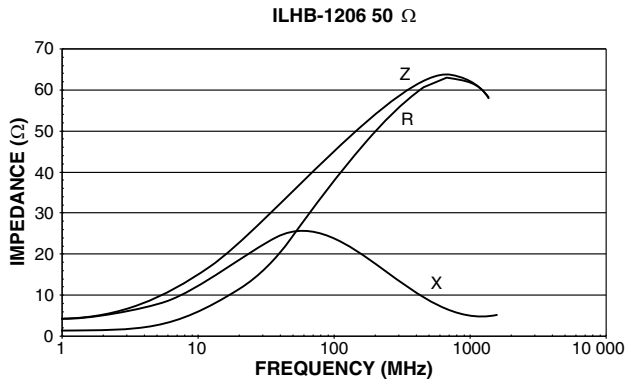



TYPICAL CURVES (Frequency Characteristics of R, X, and Z)

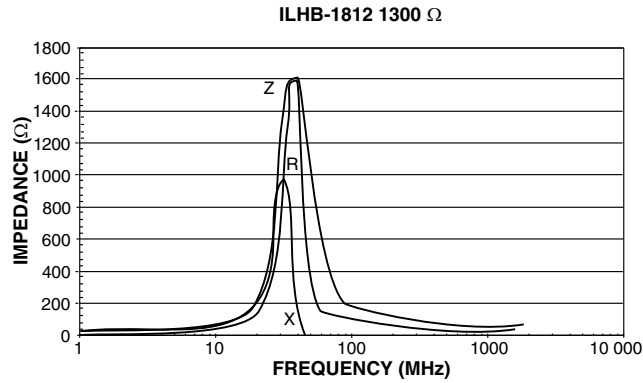

Chip Array Ferrite Beads

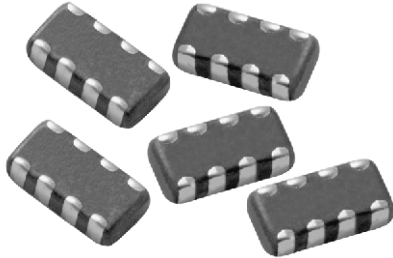

MECHANICAL SPECIFICATIONS

Solderability: 90 % coverage after 5 s dip in 235 °C solder following 60 s preheat at 120 °C to 150 °C and type R flux dip

Resistance to Solder Heat: 10 s in 260 °C solder, after preheat and flux per above

Terminal Strength: 1.2 kg (2.64 lbs) minimum for 30 s

Beam Strength: 2.0 kg (4.4 lbs) minimum

Flex: 0.079" [2 mm] min. mounted on 0.063" [1.6 mm] thick PC board

STANDARD ELECTRICAL SPECIFICATIONS

Z $\pm 25\%$ AT 100 MHz (Ω)	DCR MAX. (Ω)	RATED DC CURRENT (mA)	SIGNAL SPEED
60	0.12	300	Standard
120	0.2	150	
300	0.4	100	
600	0.6	100	
1000	0.8	50	

FEATURES

- Combines four single 0603 chips into one package to reduce board space and placement time
- Highly effective in high density applications
- 0.031" [0.8 mm] terminal pitch makes it easy to apply EMI prevention in multiple-lines such as connectors and IC pins
- Material and construction design minimize crosstalk between adjacent circuits
- Compliant to RoHS directive 2002/95/EC



RoHS
COMPLIANT

ENVIRONMENTAL SPECIFICATIONS

Operating Temperature: - 55 °C to + 125 °C

Thermal Shock: 300 cycles, - 40 °C to + 125 °C

Biased Humidity: 85 % RH at 85 °C, 1000 h at full rated current

DIMENSIONS in inches [millimeters]

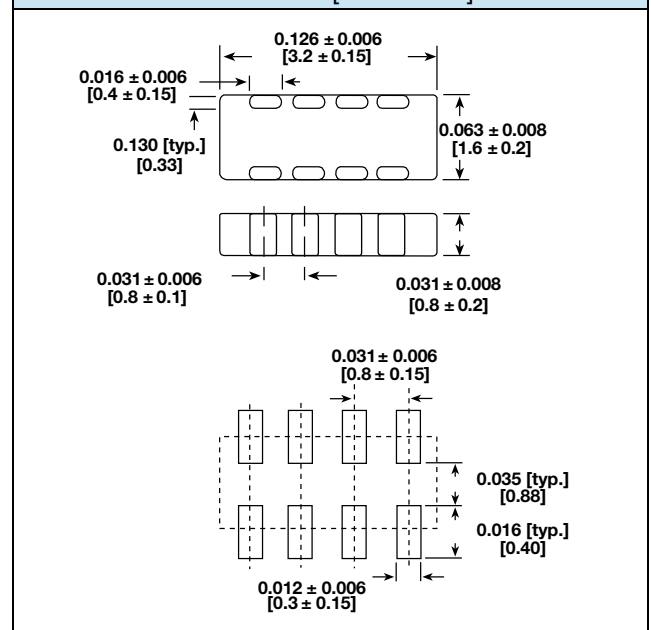

DESCRIPTION

ILAS-1206	120	$\pm 25\%$	ER	e3
MODEL	IMPEDANCE VALUE	IMPEDANCE TOLERANCE	PACKAGE CODE	JEDEC LEAD (Pb)-FREE STANDARD

GLOBAL PART NUMBER

I L A S	1 2 0 6	E R	1 2 1	V
PRODUCT FAMILY	SIZE	PACKAGE CODE	IMPEDANCE VALUE	IMPEDANCE TOLERANCE

TYPICAL CURVES - Frequency Characteristics of R, X, and Z

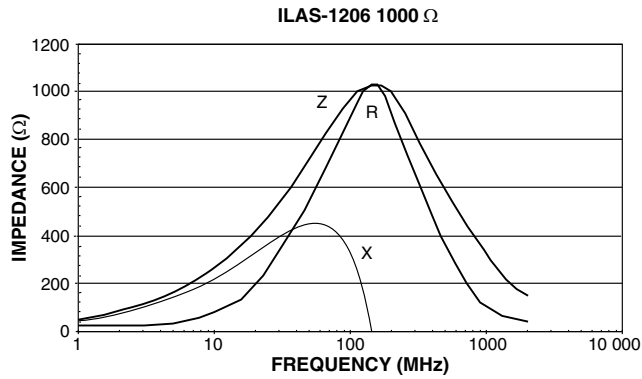
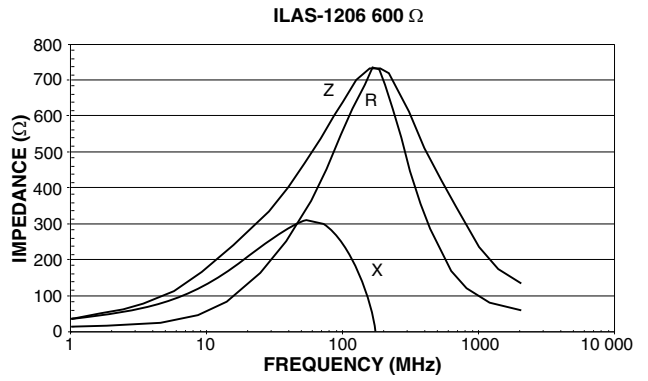
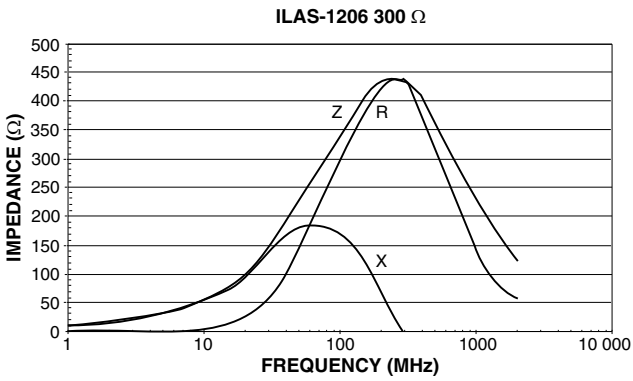
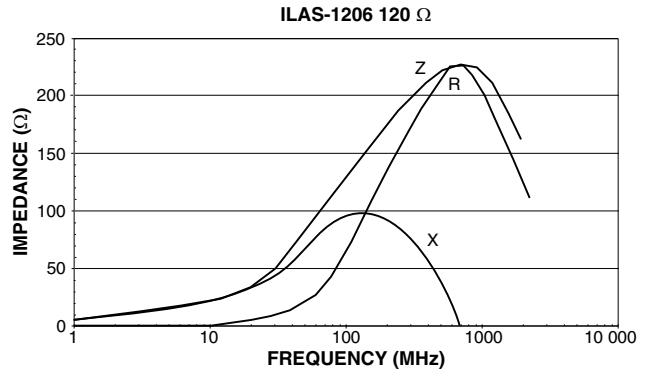
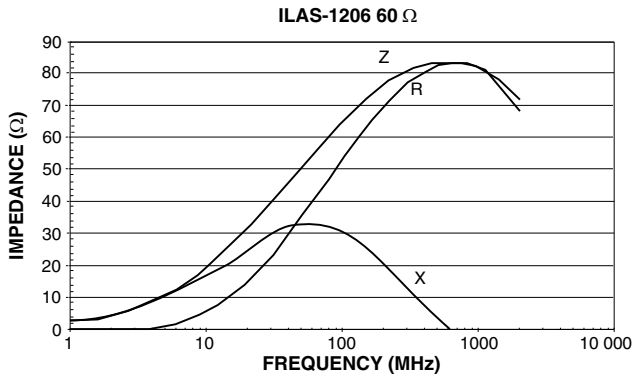



Transformers/ Inductors

Contents

LPE-3325-CST	230
LPE-3325	231
LPE-4841	233
LPE-5047	235
LPE-6562	237
LPE-6855	239
LPT-3535	241
LPT-4545	243

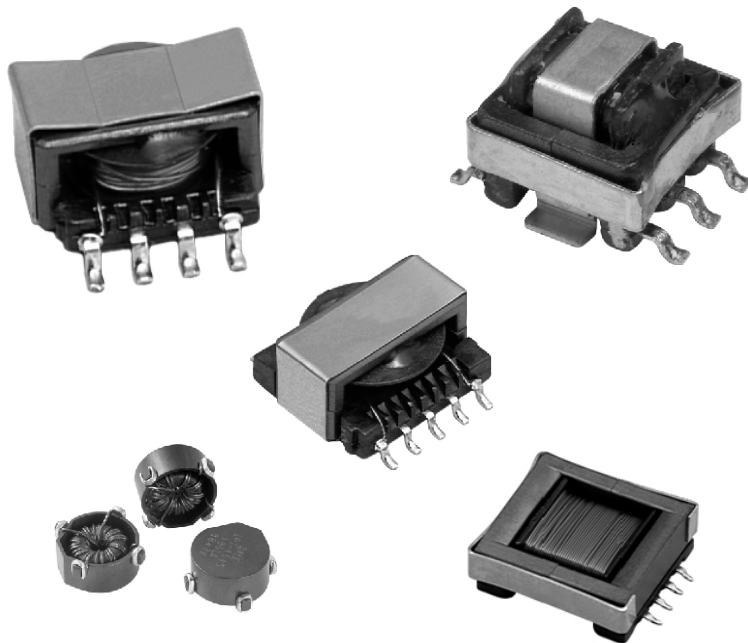

Surface Mount Current Sense Transformers

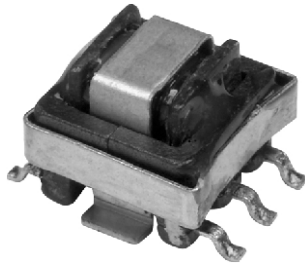

FEATURES

- Surface mount design
- Compatible with surface mount process temperatures
- Designed for switching supply applications
- Optimal performance at 100 kHz and above
- Five standard turns ratios
- Custom designs available
- Compliant to RoHS Directive 2002/95/EC

RoHS
COMPLIANT

APPLICATIONS

- Switching power supplies
- AC current detection
- Output supply for control circuitry
- Appliances
- Medical equipment
- Office equipment

STANDARD ELECTRICAL SPECIFICATIONS

MODEL	TURNS RATIO	SECONDARY		PRIMARY AMPERES
		IND. AT 100 kHz, 0.1 V MIN. (μH)	DCR MAX. (Ω)	
LPE-3325-CST030	30	180	1.00	6
LPE-3325-CST040	40	320	1.35	6
LPE-3325-CST050	50	500	2.50	6
LPE-3325-CST070	70	980	4.71	6
LPE-3325-CST125	125	3000	7.70	6

DESCRIPTION

LPE	3325	125	ER	e2
MODEL	SERIES	TURNS RATIO	PACKAGE CODE	JEDEC LEAD (Pb)-FREE STANDARD

GLOBAL PART NUMBER

L	P	E	3	3	2	5	E	R	1	2	5	C	S	T
PRODUCT FAMILY			SIZE			PACKAGE CODE		TURNS RATIO			SERIES			

DIMENSIONS in inches [millimeters]

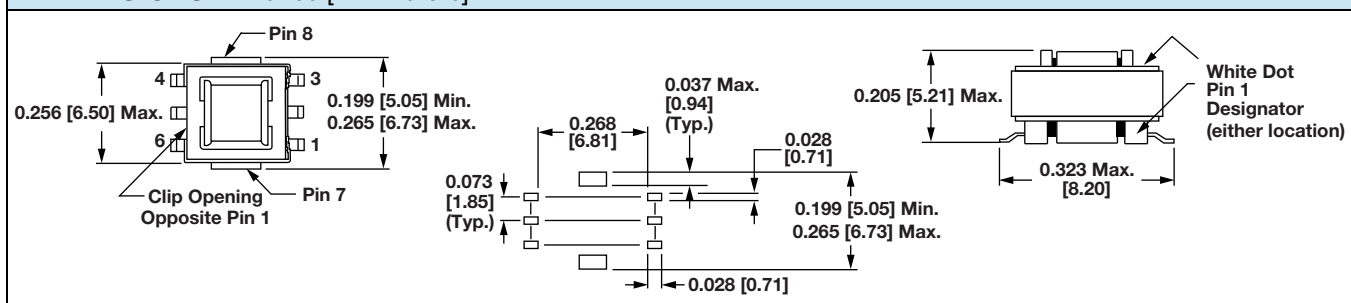

SCHEMATIC

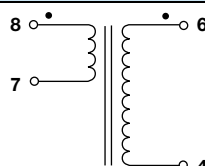

Surface Mount Transformers/Inductors, Gapped and Ungapped, Custom Configurations Available

FEATURES

- Compliant to RoHS Directive 2002/95/EC
- Halogen-free according to IEC 61249-2-21 definition

ELECTRICAL SPECIFICATIONS

Inductance Range: 10 μ H to 3900 μ H, measured at 0.10 V_{RMS} at 10 kHz without DC current, using an HP 4263A or 4284A impedance analyzer

DC Resistance Range: 0.06 Ω to 18.0 Ω , measured at + 25 °C \pm 5 °C

Rated Current Range: 1.00 A to 0.06 A

Dielectric Withstanding Voltage: 500 V_{RMS} , 60 Hz, 5 s

**RoHS
COMPLIANT
HALOGEN
FREE**

STANDARD ELECTRICAL SPECIFICATIONS

MODEL	IND. (μ H)	IND. TOL.	SCHEMATIC LETTER	DCR MAX. (Ω)	MAX. RATED DC CURRENT (A) ⁽¹⁾	SATURATING CURRENT (A) ⁽²⁾	
LPE3325ER100NU	10	\pm 30 %	A	0.06	1.01	N/A	UNGAPPED MODELS (A)
LPE3325ER150NU	15	\pm 30 %	A	0.08	0.91	N/A	
LPE3325ER220NU	22	\pm 30 %	A	0.09	0.83	N/A	
LPE3325ER330NU	33	\pm 30 %	A	0.11	0.75	N/A	
LPE3325ER470NU	47	\pm 30 %	A	0.14	0.69	N/A	
LPE3325ER680NU	68	\pm 30 %	A	0.16	0.63	N/A	
LPE3325ER101NU	100	\pm 30 %	A	0.20	0.57	N/A	
LPE3325ER151NU	150	\pm 30 %	A	0.76	0.29	N/A	
LPE3325ER221NU	220	\pm 30 %	A	0.92	0.26	N/A	
LPE3325ER331NU	330	\pm 30 %	A	1.13	0.24	N/A	
LPE3325ER471NU	470	\pm 30 %	A	1.35	0.22	N/A	
LPE3325ER681NU	680	\pm 30 %	A	1.62	0.20	N/A	
LPE3325ER102NU	1000	\pm 30 %	A	1.97	0.18	N/A	UNGAPPED MODELS (A)
LPE3325ER152NU	1500	\pm 30 %	A	2.41	0.16	N/A	
LPE3325ER222NU	2200	\pm 30 %	A	3.00	0.15	N/A	
LPE3325ER332NU	3300	\pm 30 %	A	5.96	0.10	N/A	
LPE3325ER392NU	3900	\pm 30 %	A	7.00	0.10	N/A	
LPE3325ER100MG	10	\pm 20 %	A	0.22	0.54	1.480	
LPE3325ER150MG	15	\pm 20 %	A	0.27	0.48	1.240	
LPE3325ER220MG	22	\pm 20 %	A	0.42	0.39	1.050	
LPE3325ER330MG	33	\pm 20 %	A	0.65	0.31	0.872	
LPE3325ER470MG	47	\pm 20 %	A	0.97	0.26	0.740	
LPE3325ER680MG	68	\pm 20 %	A	1.45	0.21	0.622	
LPE3325ER101MG	100	\pm 20 %	A	2.22	0.17	0.518	
LPE3325ER151MG	150	\pm 20 %	A	3.55	0.13	0.426	
LPE3325ER221MG	220	\pm 20 %	A	4.31	0.12	0.354	
LPE3325ER331MG	330	\pm 20 %	A	6.72	0.10	0.290	
LPE3325ER471MG	470	\pm 20 %	A	9.83	0.08	0.244	
LPE3325ER681MG	680	\pm 20 %	A	14.8	0.07	0.204	
LPE3325ER102MG	1000	\pm 20 %	A	18.0	0.06	0.169	

Notes

⁽¹⁾ DC current that will create a maximum temperature rise of 30 °C when applied at + 25 °C ambient.

⁽²⁾ DC current that will typically reduce the initial inductance by 20 %.

- **UNGAPPED MODELS:** Highest possible inductance with the lowest DCR and highest Q capability. Beneficial in filter, impedance matching and line coupling devices.

GAPPED MODELS: Capable of handling large amounts of DC current, tighter inductance tolerance with better temperature stability than ungapped models. Beneficial in DC/DC converters or other circuits carrying DC currents or requiring inductance stability over a temperature range.

DESCRIPTION						
LPE	3325	1000 μ H	\pm 30 %	A	ER	e2
MODEL	SIZE	INDUCTANCE VALUE	INDUCTANCE TOLERANCE	CORE	PACKAGE CODE	JEDEC LEAD (Pb)-FREE STANDARD

GLOBAL PART NUMBER													
L	P	E	3	3	2	5	E	R	1	0	2	N	U
PRODUCT FAMILY			SIZE			PACKAGE CODE		INDUCTANCE VALUE			TOL.	CORE	

Note

- Series is also available with SnPb terminations by using package code RY for tape and reel (in place of ER) or SM for bulk (in place of EB).

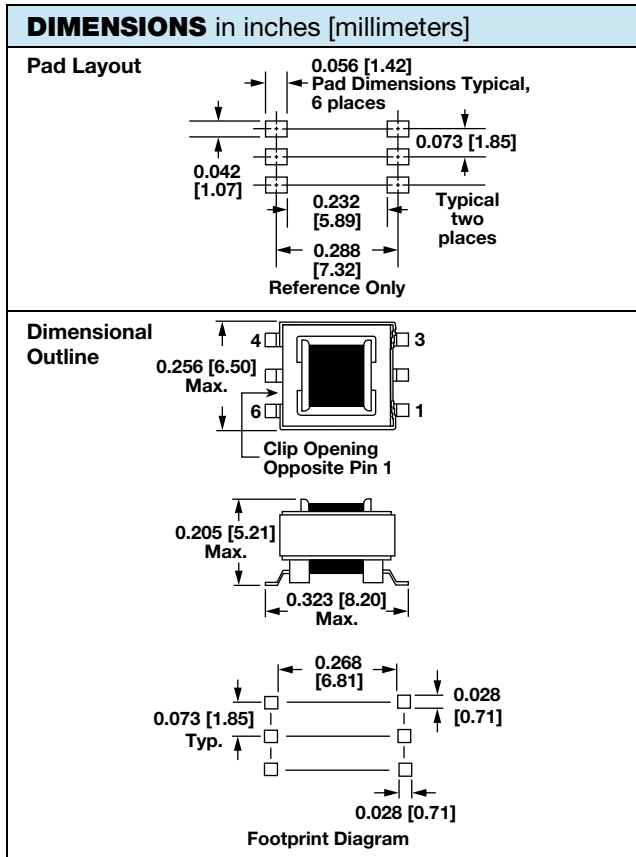

- Notes**
- Pad layout guidelines per MIL-STD-275E (printed wiring for electronic equipment).
 - Tolerances: xx ± 0.01" [± 0.25 mm]; xxx ± 0.005" [± 0.12 mm].

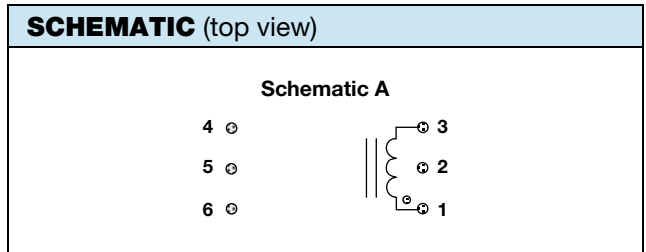

- Note**
- Schematic A for both gapped and ungapped LPE series

ENVIRONMENTAL PERFORMANCE

TEST	CONDITIONS
Thermal Cycling	Withstands - 55 °C to + 125 °C
Operating Temperature	- 55 °C to + 125 °C ⁽¹⁾
High Humidity	85 %
Soldering Heat	Tested to + 230 °C
Mechanical Shock	Per MIL-STD-202, method 213 (100G)
Vibration	Per MIL-STD-202, method 204 (20G)
Solderability	Per industry standards

- Note**
- ⁽¹⁾ Must be checked in end use application

PART MARKING

- Vishay Dale
- Date code
- Marking code (suffix of model #)
- Pin 1 indicator

PACKAGING

TAPE SPECIFICATIONS:
Carrier Tape Type: Conductive
Cover Tape Type: Anti-static
Cover Tape Adhesion to Carrier: 40 g ± 30 g

REEL SPECIFICATIONS:
Diameter (flange): 13" [330.2 mm]
Maximum Width (over flanges): 1.197" [30.4 mm]

STANDARDS: All embossed carrier tape packaging will be accomplished in compliance with latest revision of EIA-481 "Taping of Surface Mount Components for Automatic Placement".

MODEL	TAPE WIDTH	COMPONENT PITCH	UNITS PER 13" REEL
LPE-3325	24 mm	12 mm	1000

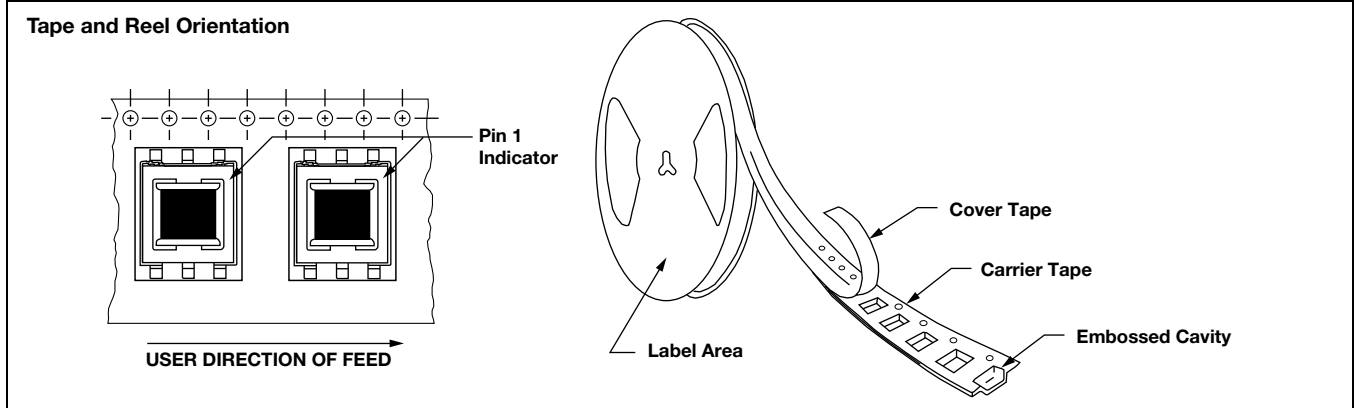

- Note**
- Top view shown with cover tape removed

Surface Mount Transformers/Inductors, Gapped and Ungapped, Custom Configurations Available

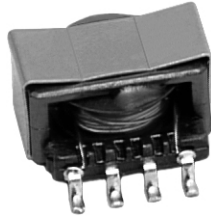
FEATURES

- Compliant to RoHS Directive 2002/95/EC
- Halogen-free according to IEC 61249-2-21 definition

ELECTRICAL SPECIFICATIONS

Inductance Range: 10 μH to 47 000 μH , measured at 0.10 V_{RMS} at 10 kHz without DC current, using an HP 4263A or HP 4284A impedance analyzer

DC Resistance Range: 0.03 Ω to 19.1 Ω , measured at + 25 $^{\circ}\text{C} \pm 5^{\circ}\text{C}$

Rated Current Range: 2.00 A to 0.09 A

Dielectric Withstanding Voltage: 500 V_{RMS} , 60 Hz, 5 s

**RoHS
COMPLIANT
HALOGEN
FREE**

STANDARD ELECTRICAL SPECIFICATIONS

MODEL	IND. (μH)	IND. TOL.	SCHEMATIC LETTER	DCR MAX. (Ω)	MAX. RATED DC CURRENT (A) ⁽¹⁾	SATURATING CURRENT (A) ⁽²⁾	
LPE4841ER101NU	100	$\pm 30\%$	A	0.17	0.88	N/A	UNGAPPED MODELS (A)
LPE4841ER151NU	150	$\pm 30\%$	A	0.21	0.79	N/A	
LPE4841ER221NU	220	$\pm 30\%$	A	0.25	0.721	N/A	
LPE4841ER331NU	330	$\pm 30\%$	A	0.30	0.65	N/A	
LPE4841ER471NU	470	$\pm 30\%$	A	0.36	0.60	N/A	
LPE4841ER681NU	680	$\pm 30\%$	A	0.44	0.54	N/A	
LPE4841ER102NU	1000	$\pm 30\%$	A	0.53	0.49	N/A	
LPE4841ER152NU	1500	$\pm 30\%$	A	0.65	0.45	N/A	
LPE4841ER222NU	2200	$\pm 30\%$	A	0.79	0.40	N/A	
LPE4841ER332NU	3300	$\pm 30\%$	A	1.55	0.29	N/A	
LPE4841ER472NU	4700	$\pm 30\%$	A	1.85	0.26	N/A	
LPE4841ER682NU	6800	$\pm 30\%$	A	4.36	0.17	N/A	
LPE4841ER103NU	10 000	$\pm 30\%$	A	5.29	0.16	N/A	
LPE4841ER153NU	15 000	$\pm 30\%$	A	6.48	0.14	N/A	
LPE4841ER223NU	22 000	$\pm 30\%$	A	13.1	0.10	N/A	
LPE4841ER333NU	33 000	$\pm 30\%$	A	16.0	0.09	N/A	
LPE4841ER473NU	47 000	$\pm 30\%$	A	19.1	0.08	N/A	
LPE4841ER100MG	10	$\pm 20\%$	B	0.03	2.03	2.320	UNGAPPED MODELS (B)
LPE4841ER150MG	15	$\pm 20\%$	B	0.04	1.84	1.925	
LPE4841ER220MG	22	$\pm 20\%$	C	0.07	1.32	1.610	
LPE4841ER330MG	33	$\pm 20\%$	C	0.09	1.20	1.330	
LPE4841ER470MG	47	$\pm 20\%$	D	0.13	0.98	1.125	
LPE4841ER680MG	68	$\pm 20\%$	D	0.21	0.79	0.941	
LPE4841ER101MG	100	$\pm 20\%$	E	0.35	0.58	0.781	
LPE4841ER151MG	150	$\pm 20\%$	E	0.48	0.52	0.641	
LPE4841ER221MG	220	$\pm 20\%$	E	0.73	0.42	0.532	
LPE4841ER331MG	330	$\pm 20\%$	E	1.14	0.34	0.436	
LPE4841ER471MG	470	$\pm 20\%$	E	1.36	0.31	0.366	
LPE4841ER681MG	680	$\pm 20\%$	E	2.07	0.25	0.305	
LPE4841ER102MG	1000	$\pm 20\%$	E	3.15	0.20	0.252	
LPE4841ER152MG	1500	$\pm 20\%$	E	4.76	0.16	0.206	
LPE4841ER222MG	2200	$\pm 20\%$	E	7.29	0.13	0.170	
LPE4841ER332MG	3300	$\pm 20\%$	E	11.7	0.11	0.139	
LPE4841ER472MG	4700	$\pm 20\%$	E	17.7	0.09	0.117	

Notes

⁽¹⁾ DC current that will create a maximum temperature rise of 30 $^{\circ}\text{C}$ when applied at + 25 $^{\circ}\text{C}$ ambient.

⁽²⁾ DC current that will typically reduce the initial inductance by 20 %.

- **UNGAPPED MODELS:** Highest possible inductance with the lowest DCR and highest Q capability. Beneficial in filter, impedance matching and line coupling devices.

GAPPED MODELS: Capable of handling large amounts of DC current, tighter inductance tolerance with better temperature stability than ungapped models. Beneficial in DC/DC converters or other circuits carrying DC currents or requiring inductance stability over a temperature range.

DESCRIPTION

LPE	4841	1000 μH	$\pm 30\%$	A	ER	e2
MODEL	SIZE	INDUCTANCE VALUE	INDUCTANCE TOLERANCE	CORE	PACKAGE CODE	JEDEC LEAD (Pb)-FREE STANDARD

GLOBAL PART NUMBER

L	P	E	4	8	4	1	E	R	1	0	2	N	U
PRODUCT FAMILY			SIZE			PACKAGE CODE		INDUCTANCE VALUE			TOL.	CORE	

Note

- Series is also available with SnPb terminations by using package code RY for tape and reel (in place of ER) or SM for bulk (in place of EB).

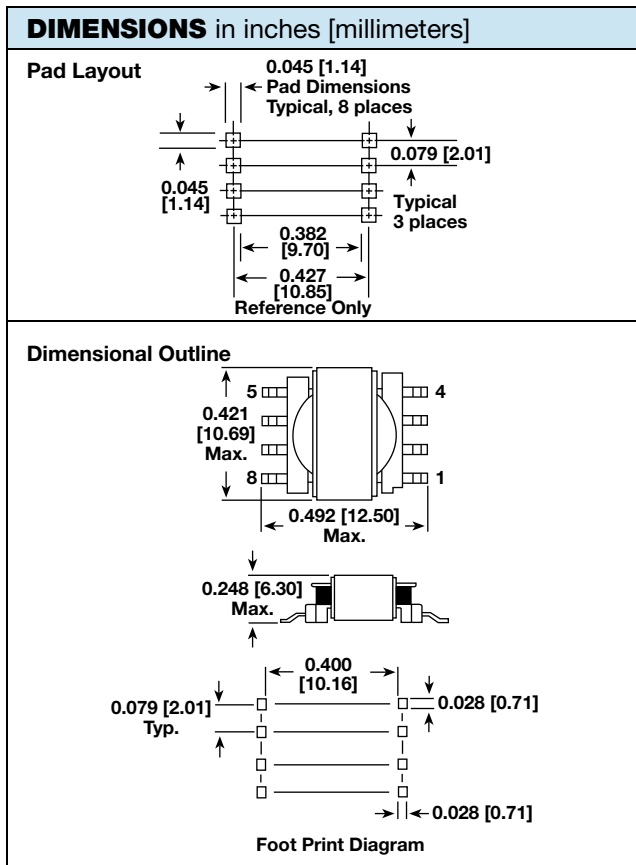

- Notes**
- Pad layout guidelines per MIL-STD-275E (printed wiring for electronic equipment).
 - Tolerances: $xx \pm 0.01''$ [± 0.25 mm]; $xxx \pm 0.005''$ [± 0.12 mm].
 - The underside of these components contains metal and thus should not come in contact with active circuit traces.

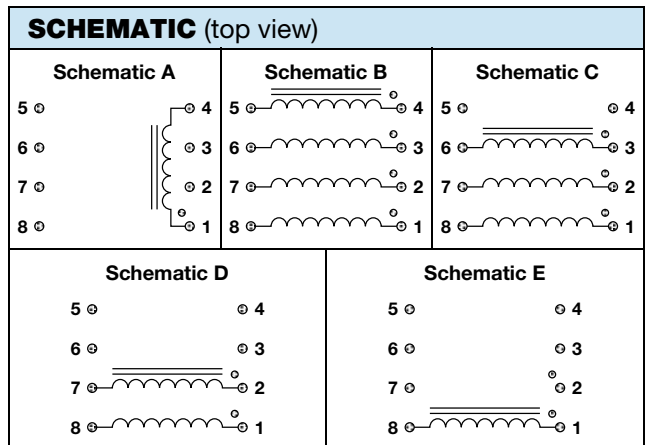

- Note**
- Schematic A is for ungapped LPE series

ENVIRONMENTAL PERFORMANCE

TEST	CONDITIONS
Thermal Cycling	Withstands - 55 °C to + 125 °C
Operating Temperature	- 55 °C to + 125 °C ⁽¹⁾
High Humidity	85 %
Soldering Heat	Tested to + 230 °C
Mechanical Shock	Per MIL-STD-202, method 213 (100G)
Vibration	Per MIL-STD-202, method 204 (20G)
Solderability	Per industry standards

- Note**
- ⁽¹⁾ Must be checked in end use application

PART MARKING

- Vishay Dale
- Date code
- Marking code (suffix of model #)
- Pin 1 indicator

PACKAGING

TAPE SPECIFICATIONS:
Carrier Tape Type: Conductive
Cover Tape Type: Anti-static
Cover Tape Adhesion to Carrier: 40 g ± 30 g

REEL SPECIFICATIONS:
Diameter (flange): 13" [330.2 mm]
Maximum Width (over flanges): 1.197" [30.4 mm]

STANDARDS: All embossed carrier tape packaging will be accomplished in compliance with latest revision of EIA-481 "Taping of Surface Mount Components for Automatic Placement".

MODEL	TAPE WIDTH	COMPONENT PITCH	UNITS PER 13" REEL
LPE-4841	24 mm	16 mm	600

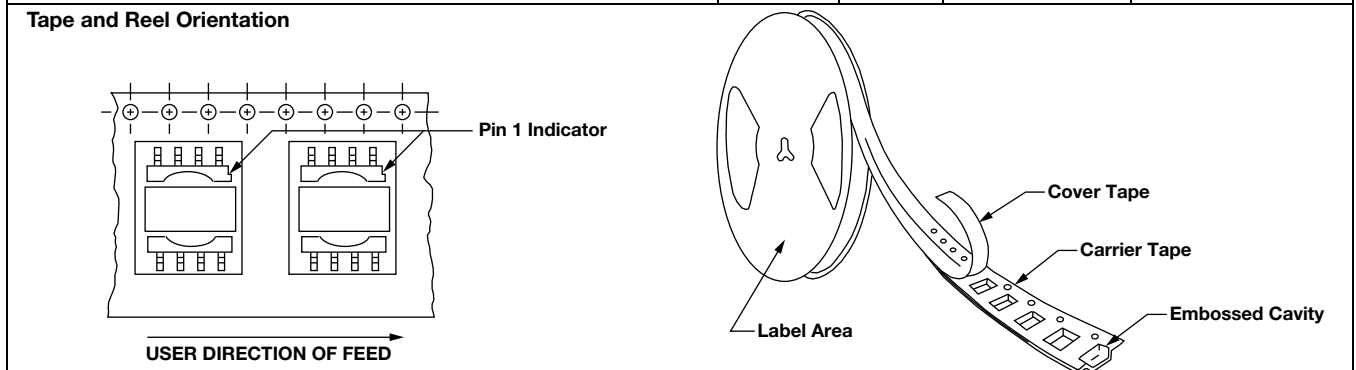

- Note**
- Top view shown with cover tape removed

Surface Mount Transformers/Inductors, Gapped and Ungapped, Custom Configurations Available

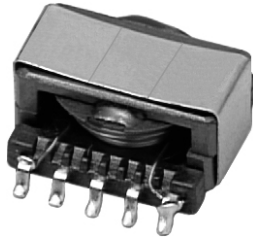
FEATURES

- Compliant to RoHS directive 2002/95/EC

ELECTRICAL SPECIFICATIONS

(multiple winds are connected in parallel)

Inductance Range: 10 μH to 68 000 μH , measured at 0.10 V_{RMS} at 10 kHz without DC current, using an HP 4263A or HP 4284A impedance analyzer

DC Resistance Range: 0.03 Ω to 24.1 Ω , measured at + 25 $^{\circ}\text{C} \pm 5^{\circ}\text{C}$
Rated Current Range: 2.29 A to 0.07 A

Dielectric Withstanding Voltage: 500 V_{RMS} , 60 Hz, 5 s

**RoHS
COMPLIANT**
STANDARD ELECTRICAL SPECIFICATIONS

MODEL	IND. (μH)	IND. TOL.	SCHEMATIC LETTER	DCR MAX. (Ω)	MAX. RATED DC CURRENT (A) ⁽¹⁾	SATURATING CURRENT (A) ⁽²⁾	
LPE5047ER151NU	150	$\pm 30\%$	A	0.20	0.79	N/A	UNGAPPED MODELS (A)
LPE5047ER221NU	220	$\pm 30\%$	A	0.24	0.72	N/A	
LPE5047ER331NU	330	$\pm 30\%$	A	0.29	0.65	N/A	
LPE5047ER471NU	470	$\pm 30\%$	A	0.35	0.59	N/A	
LPE5047ER681NU	680	$\pm 30\%$	A	0.42	0.54	N/A	
LPE5047ER102NU	1000	$\pm 30\%$	A	0.51	0.49	N/A	
LPE5047ER152NU	1500	$\pm 30\%$	A	0.63	0.44	N/A	
LPE5047ER222NU	2200	$\pm 30\%$	A	0.76	0.40	N/A	
LPE5047ER332NU	3300	$\pm 30\%$	A	1.00	0.35	N/A	
LPE5047ER472NU	4700	$\pm 30\%$	A	2.24	0.24	N/A	
LPE5047ER682NU	6800	$\pm 30\%$	A	2.70	0.21	N/A	
LPE5047ER103NU	10 000	$\pm 30\%$	A	3.27	0.19	N/A	UNGAPPED MODELS (A)
LPE5047ER153NU	15 000	$\pm 30\%$	A	6.26	0.14	N/A	
LPE5047ER223NU	22 000	$\pm 30\%$	A	7.58	0.13	N/A	
LPE5047ER333NU	33 000	$\pm 30\%$	A	9.50	0.11	N/A	
LPE5047ER473NU	47 000	$\pm 30\%$	A	18.5	0.08	N/A	
LPE5047ER683NU	68 000	$\pm 30\%$	A	24.1	0.07	N/A	
LPE5047ER100MG	10	$\pm 20\%$	B	0.03	2.29	2.690	GAPPED MODELS (B)
LPE5047ER150MG	15	$\pm 20\%$	B	0.04	2.07	2.230	
LPE5047ER220MG	22	$\pm 20\%$	B	0.05	1.68	1.860	
LPE5047ER330MG	33	$\pm 20\%$	C	0.09	1.35	1.540	
LPE5047ER470MG	47	$\pm 20\%$	D	0.13	1.11	1.300	
LPE5047ER680MG	68	$\pm 20\%$	D	0.15	1.01	1.085	
LPE5047ER101MG	100	$\pm 20\%$	D	0.24	0.81	0.900	GAPPED MODELS (B)
LPE5047ER151MG	150	$\pm 20\%$	D	0.37	0.65	0.740	
LPE5047ER221MG	220	$\pm 20\%$	E	0.55	0.53	0.610	
LPE5047ER331MG	330	$\pm 20\%$	E	0.85	0.43	0.500	
LPE5047ER471MG	470	$\pm 20\%$	E	1.29	0.35	0.420	
LPE5047ER681MG	680	$\pm 20\%$	E	1.96	0.28	0.350	
LPE5047ER102MG	1000	$\pm 20\%$	E	2.38	0.26	0.290	
LPE5047ER152MG	1500	$\pm 20\%$	E	3.66	0.21	0.240	
LPE5047ER222MG	2200	$\pm 20\%$	E	5.47	0.17	0.195	
LPE5047ER332MG	3300	$\pm 20\%$	E	8.48	0.14	0.160	
LPE5047ER472MG	4700	$\pm 20\%$	E	13.2	0.11	0.135	

Notes
⁽¹⁾ DC current that will create a maximum temperature rise of 30 $^{\circ}\text{C}$ when applied at + 25 $^{\circ}\text{C}$ ambient.

⁽²⁾ DC current that will typically reduce the initial inductance by 20 %.

- UNGAPPED MODELS:** Highest possible inductance with the lowest DCR and highest Q capability. Beneficial in filter, impedance matching and line coupling devices.

GAPPED MODELS: Capable of handling large amounts of DC current, tighter inductance tolerance with better temperature stability than ungapped models. Beneficial in DC/DC converters or other circuits carrying DC currents or requiring inductance stability over a temperature range.

DESCRIPTION

LPE	5047	1000 μH	$\pm 30\%$	A	ER	e2
MODEL	SIZE	INDUCTANCE VALUE	INDUCTANCE TOLERANCE	CORE	PACKAGE CODE	JEDEC LEAD (Pb)-FREE STANDARD

GLOBAL PART NUMBER

L	P	E	5	0	4	7	E	R	1	0	2	N	U
PRODUCT FAMILY			SIZE			PACKAGE CODE		INDUCTANCE VALUE			TOL.	CORE	

Note

- Series is also available with SnPb terminations by using package code RY for tape and reel (in place of ER) or SM for bulk (in place of EB).

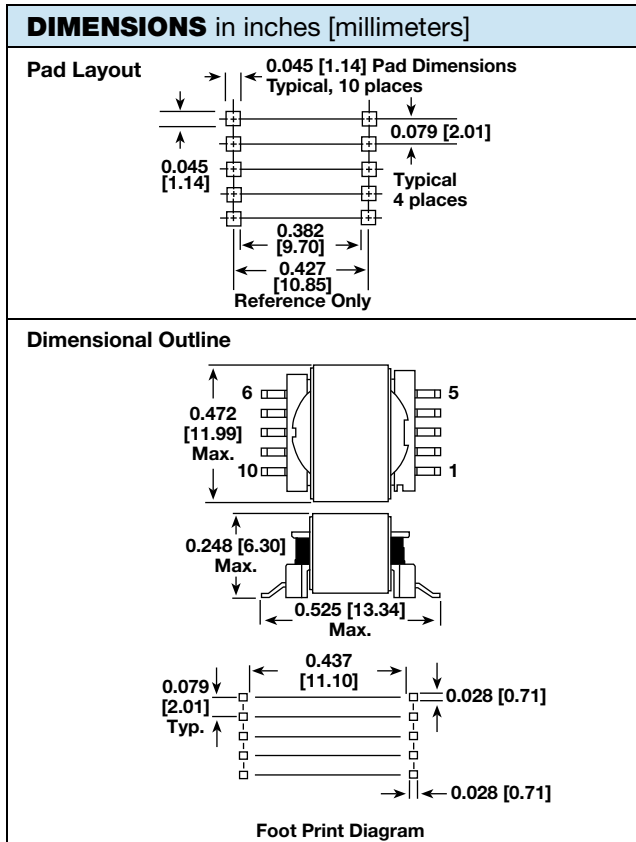

- Notes**
- Pad layout guidelines per MIL-STD-275E (printed wiring for electronic equipment).
 - Tolerances: xx ± 0.01" [± 0.25 mm]; xxx ± 0.005" [± 0.12 mm].
 - The underside of these components contains metal and thus should not come in contact with active circuit traces.

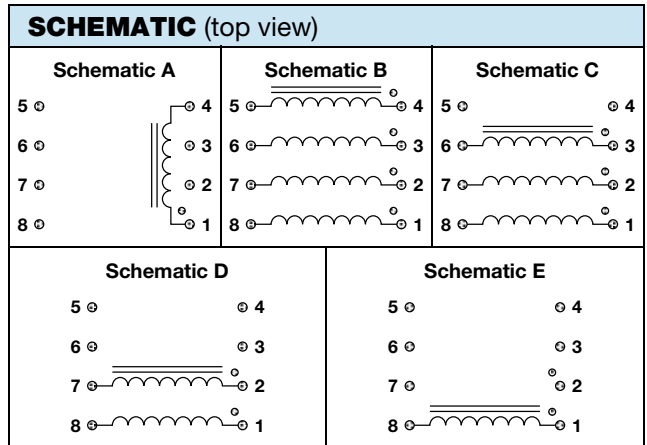

- Note**
- Schematic A is for ungapped LPE series

ENVIRONMENTAL PERFORMANCE

TEST	CONDITIONS
Thermal Cycling	Withstands - 55 °C to + 125 °C
Operating Temperature	- 55 °C to + 125 °C ⁽¹⁾
High Humidity	85 %
Soldering Heat	Tested to + 230 °C
Mechanical Shock	Per MIL-STD-202, method 213 (100G)
Vibration	Per MIL-STD-202, method 204 (20G)
Solderability	Per industry standards

- Note**
- ⁽¹⁾ Must be checked in end use application

PART MARKING

- Vishay Dale
- Date code
- Marking code (suffix of model #)
- Pin 1 indicator

PACKAGING

TAPE SPECIFICATIONS:
Carrier Tape Type: Conductive
Cover Tape Type: Anti-static
Cover Tape Adhesion to Carrier: 40 g ± 30 g

REEL SPECIFICATIONS:
Diameter (flange): 13" [330.2 mm]
Maximum Width (over flanges): 1.197" [30.4 mm]

STANDARDS: All embossed carrier tape packaging will be accomplished in compliance with latest revision of EIA-481 "Taping of Surface Mount Components for Automatic Placement".

MODEL	TAPE WIDTH	COMPONENT PITCH	UNITS PER 13" REEL
LPE-5047	24 mm	16 mm	600

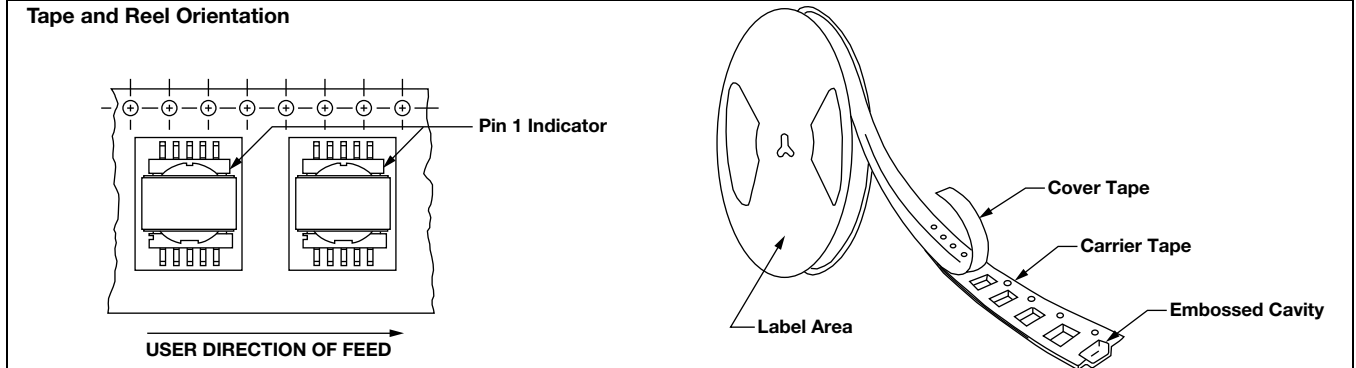

- Note**
- Top view shown with cover tape removed

Surface Mount Transformers/Inductors, Gapped and Ungapped, Custom Configurations Available

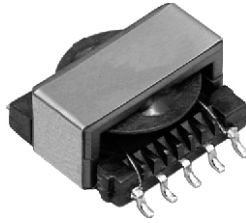
FEATURES

- Compliant to RoHS directive 2002/95/EC

ELECTRICAL SPECIFICATIONS

(multiple winds are connected in parallel)

Inductance Range: 10 μ H to 330 000 μ H, measured at 0.10 V_{RMS} at 10 kHz without DC current, using an HP 4263A or HP 4284A impedance analyzer

DC Resistance Range: 0.03 Ω to 53.7 Ω , measured at + 25 °C \pm 5 °C

Rated Current Range: 3.00 A to 0.06 A

Dielectric Withstanding Voltage: 500 V_{RMS}, 60 Hz, 5 s

**RoHS
COMPLIANT**
STANDARD ELECTRICAL SPECIFICATIONS

MODEL	IND. (μ H)	IND. TOL.	SCHEMATIC LETTER	DCR MAX. (Ω)	MAX. RATED DC CURRENT (A) ⁽¹⁾	SATURATING CURRENT (A) ⁽²⁾	
LPE6562ER221NU	220	\pm 30 %	A	0.28	0.90	N/A	UNGAPPED MODELS (A)
LPE6562ER331NU	330	\pm 30 %	A	0.34	0.81	N/A	
LPE6562ER471NU	470	\pm 30 %	A	0.40	0.74	N/A	
LPE6562ER681NU	680	\pm 30 %	A	0.48	0.67	N/A	
LPE6562ER102NU	1000	\pm 30 %	A	0.59	0.61	N/A	
LPE6562ER152NU	1500	\pm 30 %	A	0.72	0.55	N/A	
LPE6562ER222NU	2200	\pm 30 %	A	0.87	0.50	N/A	
LPE6562ER332NU	3300	\pm 30 %	A	1.07	0.45	N/A	
LPE6562ER472NU	4700	\pm 30 %	A	1.27	0.41	N/A	
LPE6562ER682NU	6800	\pm 30 %	A	1.53	0.38	N/A	
LPE6562ER103NU	10 000	\pm 30 %	A	1.86	0.34	N/A	
LPE6562ER153NU	15 000	\pm 30 %	A	2.27	0.31	N/A	
LPE6562ER223NU	22 000	\pm 30 %	A	8.67	0.16	N/A	
LPE6562ER333NU	33 000	\pm 30 %	A	10.6	0.14	N/A	
LPE6562ER473NU	47 000	\pm 30 %	A	12.7	0.13	N/A	
LPE6562ER683NU	68 000	\pm 30 %	A	15.2	0.12	N/A	
LPE6562ER104NU	100 000	\pm 30 %	A	18.5	0.11	N/A	
LPE6562ER154NU	150 000	\pm 30 %	A	37.7	0.08	N/A	
LPE6562ER224NU	220 000	\pm 30 %	A	45.6	0.07	N/A	
LPE6562ER334NU	330 000	\pm 30 %	A	53.7	0.06	N/A	
LPE6562ER100MG	10	\pm 20 %	B	0.03	3.09	5.055	GAPPED MODELS (B)
LPE6562ER150MG	15	\pm 20 %	B	0.04	2.79	4.160	
LPE6562ER220MG	22	\pm 20 %	B	0.05	2.26	3.460	
LPE6562ER330MG	33	\pm 20 %	B	0.08	1.81	2.840	
LPE6562ER470MG	47	\pm 20 %	D	0.12	1.48	2.390	
LPE6562ER680MG	68	\pm 20 %	C	0.19	1.20	1.990	
LPE6562ER101MG	100	\pm 20 %	D	0.29	0.98	1.650	
LPE6562ER151MG	150	\pm 20 %	E	0.45	0.78	1.350	
LPE6562ER221MG	220	\pm 20 %	E	0.54	0.71	1.115	
LPE6562ER331MG	330	\pm 20 %	E	0.84	0.57	0.912	
LPE6562ER471MG	470	\pm 20 %	E	1.24	0.47	0.765	
LPE6562ER681MG	680	\pm 20 %	E	1.89	0.38	0.637	
LPE6562ER102MG	1000	\pm 20 %	E	2.91	0.31	0.526	
LPE6562ER152MG	1500	\pm 20 %	E	4.50	0.25	0.430	
LPE6562ER222MG	2200	\pm 20 %	E	6.90	0.20	0.355	
LPE6562ER332MG	3300	\pm 20 %	E	10.4	0.16	0.290	
LPE6562ER472MG	4700	\pm 20 %	E	15.7	0.13	0.243	

Notes
⁽¹⁾ DC current that will create a maximum temperature rise of 30 °C when applied at + 25 °C ambient.

⁽²⁾ DC current that will typically reduce the initial inductance by 20 %.

- UNGAPPED MODELS:** Highest possible inductance with the lowest DCR and highest Q capability. Beneficial in filter, impedance matching and line coupling devices.

GAPPED MODELS: Capable of handling large amounts of DC current, tighter inductance tolerance with better temperature stability than ungapped models. Beneficial in DC/DC converters or other circuits carrying DC currents or requiring inductance stability over a temperature range.

DESCRIPTION

LPE	6562	1000 μ H	\pm 30 %	A	ER	e2
MODEL	SIZE	INDUCTANCE VALUE	INDUCTANCE TOLERANCE	CORE	PACKAGE CODE	JEDEC LEAD (Pb)-FREE STANDARD

GLOBAL PART NUMBER

L	P	E	6	5	6	2	E	R	1	0	2	N	T
PRODUCT FAMILY			SIZE			PACKAGE CODE		INDUCTANCE VALUE			TOL.	CORE	

Note

- Series is also available with SnPb terminations by using package code RY for tape and reel (in place of ER) or SM for bulk (in place of EB).

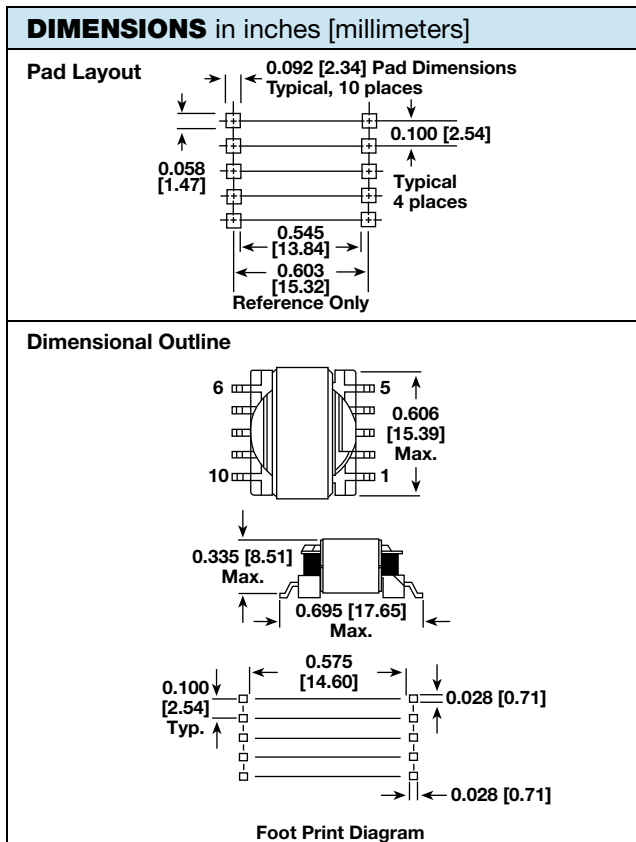

- Notes**
- Pad layout guidelines per MIL-STD-275E (printed wiring for electronic equipment).
 - Tolerances: xx ± 0.01" [± 0.25 mm]; xxx ± 0.005" [± 0.12 mm].
 - The underside of these components contains metal and thus should not come in contact with active circuit traces.

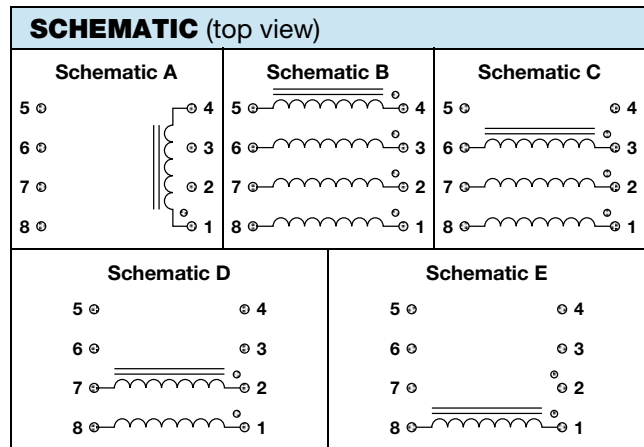

- Note**
- Schematic A is for ungapped LPE series

ENVIRONMENTAL PERFORMANCE

TEST	CONDITIONS
Thermal Cycling	Withstands - 55 °C to + 125 °C
Operating Temperature	- 55 °C to + 125 °C ⁽¹⁾
High Humidity	85 %
Soldering Heat	Tested to + 230 °C
Mechanical Shock	Per MIL-STD-202, method 213 (100G)
Vibration	Per MIL-STD-202, method 204 (20G)
Solderability	Per industry standards

- Note**
- ⁽¹⁾ Must be checked in end use application

PART MARKING

- Vishay Dale
- Date code
- Marking code (suffix of model #)
- Pin 1 indicator

PACKAGING

TAPE SPECIFICATIONS:
Carrier Tape Type: Conductive
Cover Tape Type: Anti-static
Cover Tape Adhesion to Carrier: 40 g ± 30 g

REEL SPECIFICATIONS:
Diameter (flange): 13" [330.2 mm]
Maximum Width (over flanges): 1.197" [30.4 mm]

STANDARDS: All embossed carrier tape packaging will be accomplished in compliance with latest revision of EIA-481 "Taping of Surface Mount Components for Automatic Placement".

MODEL	TAPE WIDTH	COMPONENT PITCH	UNITS PER 13" REEL
LPE-6562	32 mm	20 mm	300

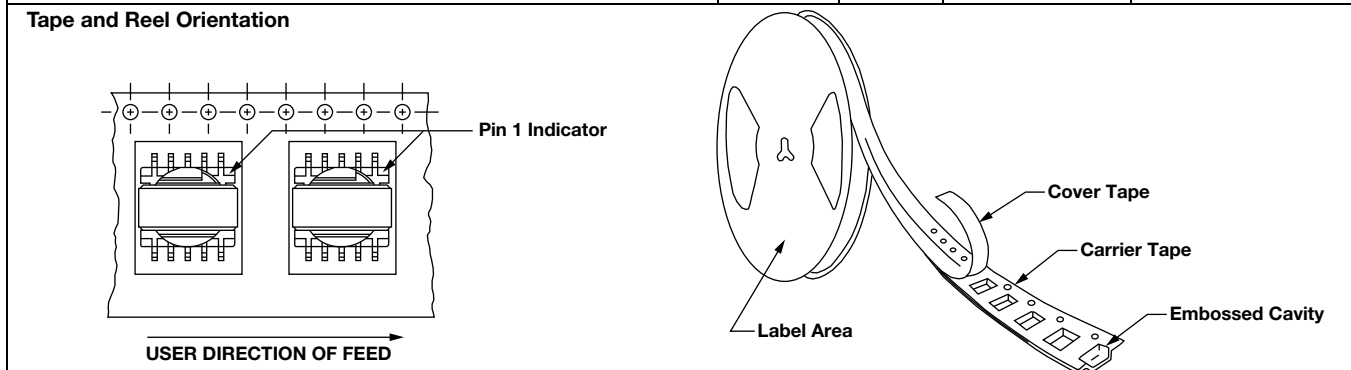

- Note**
- Top view shown with cover tape removed

Surface Mount Transformers/Inductors, Gapped and Ungapped, Custom Configurations Available

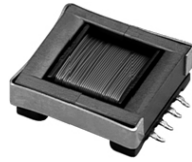
FEATURES

- Compliant to RoHS directive 2002/95/EC

ELECTRICAL SPECIFICATIONS

(Multiple winds are connected in parallel)

Inductance Range: 10 μ H to 150 000 μ H, measured at 0.10 V_{RMS} at 10 kHz without DC current, using an HP 4263A or HP 4284A impedance analyzer

DC Resistance Range: 0.02 Ω to 46.2 Ω , measured at + 25 °C \pm 5 °C

Rated Current Range: 3.20 A to 0.17 A

Dielectric Withstanding Voltage: 500 V_{RMS}, 60 Hz, 5 s

RoHS COMPLIANT
STANDARD ELECTRICAL SPECIFICATIONS

MODEL	IND. (μ H)	IND. TOL.	SCHEMATIC LETTER	DCR MAX. (Ω)	MAX. RATED DC CURRENT (A) ⁽¹⁾	SATURATING CURRENT (A) ⁽²⁾	
LPE6855ER151NU	150	\pm 30 %	A	0.28	0.84	N/A	UNGAPPED MODELS (A)
LPE6855ER221NU	220	\pm 30 %	A	0.34	0.76	N/A	
LPE6855ER331NU	330	\pm 30 %	A	0.41	0.69	N/A	
LPE6855ER471NU	470	\pm 30 %	A	0.49	0.63	N/A	
LPE6855ER681NU	680	\pm 30 %	A	0.59	0.57	N/A	
LPE6855ER102NU	1000	\pm 30 %	A	0.72	0.52	N/A	
LPE6855ER152NU	1500	\pm 30 %	A	0.88	0.47	N/A	
LPE6855ER222NU	2200	\pm 30 %	A	1.07	0.43	N/A	
LPE6855ER332NU	3300	\pm 30 %	A	1.31	0.39	N/A	
LPE6855ER472NU	4700	\pm 30 %	A	1.56	0.35	N/A	
LPE6855ER682NU	6800	\pm 30 %	A	1.88	0.32	N/A	
LPE6855ER103NU	10 000	\pm 30 %	A	7.17	0.16	N/A	
LPE6855ER153NU	15 000	\pm 30 %	A	8.78	0.15	N/A	
LPE6855ER223NU	22 000	\pm 30 %	A	10.6	0.14	N/A	
LPE6855ER333NU	33 000	\pm 30 %	A	13.0	0.12	N/A	
LPE6855ER473NU	47 000	\pm 30 %	A	15.5	0.11	N/A	
LPE6855ER683NU	68 000	\pm 30 %	A	18.7	0.10	N/A	
LPE6855ER104NU	100 000	\pm 30 %	A	37.7	0.07	N/A	
LPE6855ER154NU	150 000	\pm 30 %	A	46.2	0.06	N/A	
LPE6855ER100MG	10	\pm 20 %	B	0.02	3.21	3.375	GAPPED MODELS (B)
LPE6855ER150MG	15	\pm 20 %	B	0.03	2.90	2.790	
LPE6855ER220MG	22	\pm 20 %	B	0.04	2.64	2.325	
LPE6855ER330MG	33	\pm 20 %	B	0.05	2.12	1.910	
LPE6855ER470MG	47	\pm 20 %	B	0.08	1.73	1.610	
LPE6855ER680MG	68	\pm 20 %	B	0.12	1.41	1.350	
LPE6855ER101MG	100	\pm 20 %	B	0.15	1.28	1.120	
LPE6855ER151MG	150	\pm 20 %	C	0.23	1.02	0.915	
LPE6855ER221MG	220	\pm 20 %	D	0.35	0.83	0.757	
LPE6855ER331MG	330	\pm 20 %	D	0.55	0.67	0.620	
LPE6855ER471MG	470	\pm 20 %	D	0.82	0.54	0.520	
LPE6855ER681MG	680	\pm 20 %	E	1.23	0.45	0.433	
LPE6855ER102MG	1000	\pm 20 %	E	1.89	0.36	0.358	
LPE6855ER152MG	1500	\pm 20 %	E	2.90	0.29	0.292	
LPE6855ER222MG	2200	\pm 20 %	E	4.50	0.23	0.242	
LPE6855ER332MG	3300	\pm 20 %	E	5.50	0.21	0.197	
LPE6855ER472MG	4700	\pm 20 %	E	8.30	0.17	0.166	

Notes
⁽¹⁾ DC current that will create a maximum temperature rise of 30 °C when applied at + 25 °C ambient.

⁽²⁾ DC current that will typically reduce the initial inductance by 20 %.

- UNGAPPED MODELS:** Highest possible inductance with the lowest DCR and highest Q capability. Beneficial in filter, impedance matching and line coupling devices.

GAPPED MODELS: Capable of handling large amounts of DC current, tighter inductance tolerance with better temperature stability than ungapped models. Beneficial in DC/DC converters or other circuits carrying DC currents or requiring inductance stability over a temperature range.

DESCRIPTION

LPE	6855	1000 μ H	\pm 30 %	A	ER	e2
MODEL	SIZE	INDUCTANCE VALUE	INDUCTANCE TOLERANCE	CORE	PACKAGE CODE	JEDEC LEAD (Pb)-FREE STANDARD

GLOBAL PART NUMBER

L	P	E	6	8	5	5	E	R	1	0	2	N	U
PRODUCT FAMILY			SIZE			PACKAGE CODE		INDUCTANCE VALUE			TOL.	CORE	

Note

- Series is also available with SnPb terminations by using package code RY for tape and reel (in place of ER) or SM for bulk (in place of EB).

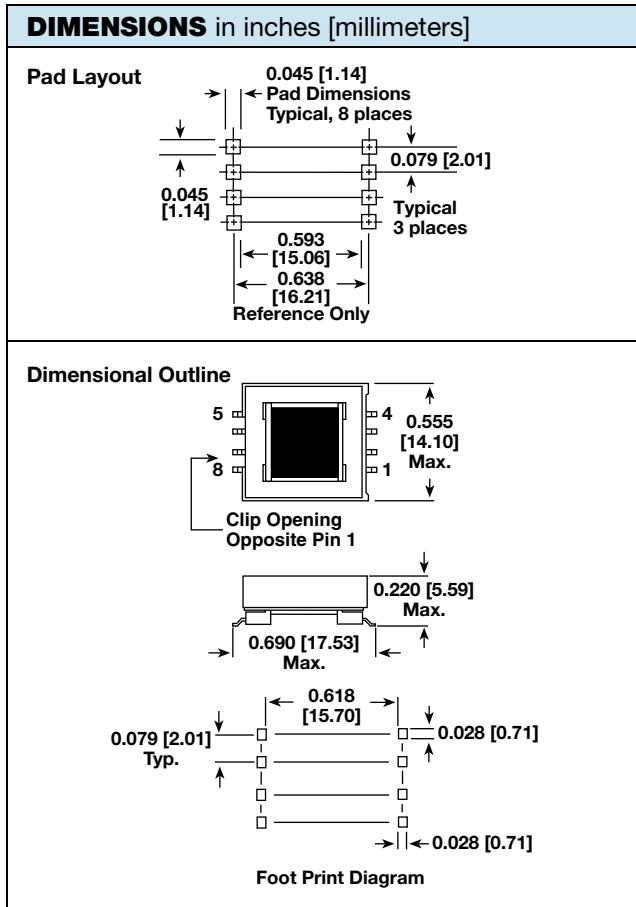

- Notes**
- Pad layout guidelines per MIL-STD-275E (printed wiring for electronic equipment).
 - Tolerances: xx ± 0.01" [± 0.25 mm]; xxx ± 0.005" [± 0.12 mm].

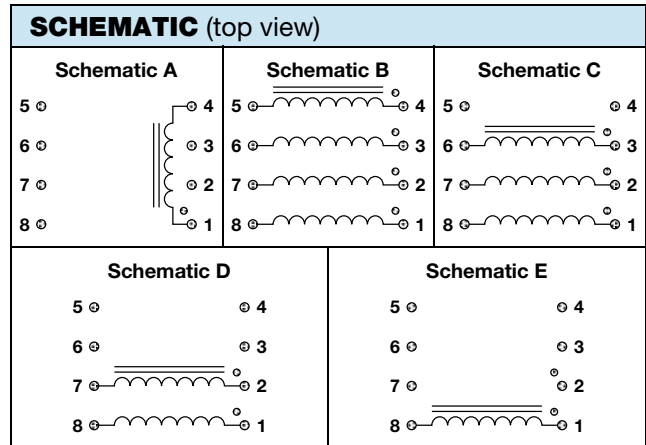

- Note**
- Schematic A is for ungapged LPE series

ENVIRONMENTAL PERFORMANCE

TEST	CONDITIONS
Thermal Cycling	Withstands - 55 °C to + 125 °C
Operating Temperature	- 55 °C to + 125 °C ⁽¹⁾
High Humidity	85 %
Soldering Heat	Tested to + 230 °C
Mechanical Shock	Per MIL-STD-202, method 213 (100G)
Vibration	Per MIL-STD-202, method 204 (20G)
Solderability	Per industry standards

- Note**
- ⁽¹⁾ Must be checked in end use application

PART MARKING

- Vishay Dale
- Date code
- Marking code (suffix of model #)
- Pin 1 indicator

PACKAGING

MODEL	TAPE WIDTH	COMPONENT PITCH	UNITS PER 13" REEL
LPE-6855	32 mm	20 mm	450

TAPE SPECIFICATIONS:
Carrier Tape Type: Conductive
Cover Tape Type: Anti-static
Cover Tape Adhesion to Carrier: 40 g ± 30 g

REEL SPECIFICATIONS:
Diameter (flange): 13" [330.2 mm]
Maximum Width (over flanges): 1.197" [30.4 mm]

STANDARDS: All embossed carrier tape packaging will be accomplished in compliance with latest revision of EIA-481 "Taping of Surface Mount Components for Automatic Placement".

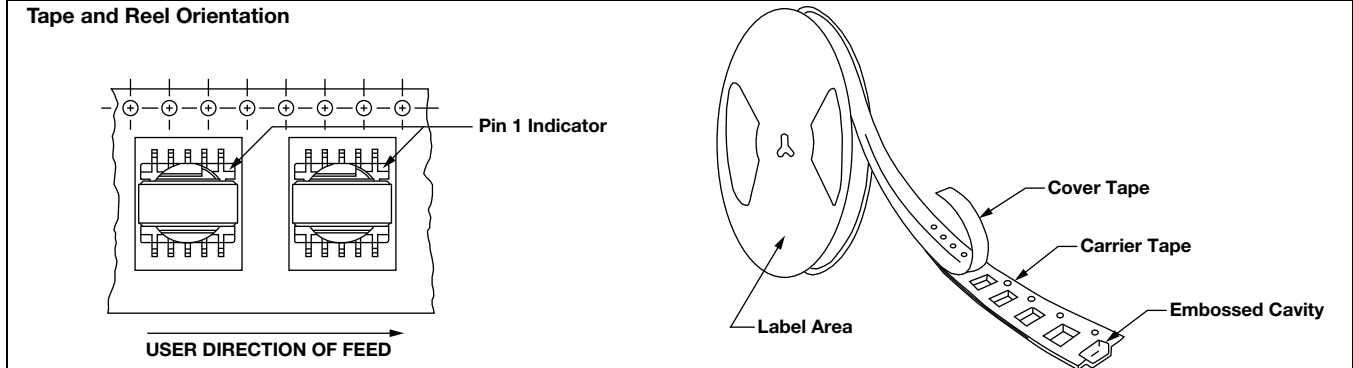

- Note**
- Top view shown with cover tape removed

Inductors/Transformers Customizable, Surface Mount Torodial, Kool Mu[®], Powdered Iron and MPP Cores

Note

- Kool Mu[®] is a registered trademark of Spang & Company

FEATURES

- Toroidal design for minimal EMI radiation in DC/DC converter applications
- Designed to support the growing need for efficient DC/DC converters in battery operated equipment
- Two separate windings provide versatility by ability to connect windings in series or parallel
- Operating temperature range: - 40 °C to + 125 °C
- Supplied on tape and reel and is designed to be pick and place compatible
- Custom versions and turns ratios available. Contact the factory with your specifications
- Compliant to RoHS Directive 2002/95/EC
- Halogen-free according to IEC 61249-2-21 definition

RoHS
COMPLIANT
HALOGEN
FREE

STANDARD ELECTRICAL SPECIFICATIONS (in parallel)						
MODEL	STD. IND. (μH)	IND. TOL.	ACTUAL IND. (LOC) (μH)	DCR (Ω)	RATED I _{DC} (40 °C)	IND. AT I _{DC} (L-BIAS) (30 %)
LPT3535ER1ROLK	1.0	± 15 %	0.800	0.005	6.42	0.48 at 7.05
LPT3535ER1R5LK	1.5	± 15 %	1.80	0.009	4.77	1.07 at 4.70
LPT3535ER2R5LK	2.5	± 15 %	2.45	0.011	4.45	1.46 at 4.03
LPT3535ER3R3LK	3.3	± 15 %	3.20	0.015	3.73	1.90 at 3.52
LPT3535ER5R0LK	5.0	± 15 %	5.00	0.023	3.01	2.98 at 2.82
LPT3535ER100LK	10	± 15 %	11.3	0.055	1.95	6.69 at 1.88
LPT3535ER150LK	15	± 15 %	16.2	0.081	1.59	9.64 at 1.57
LPT3535ER250LK	25	± 15 %	26.5	0.131	1.25	15.7 at 1.23
LPT3535ER330LK	33	± 15 %	33.8	0.182	1.05	20.1 at 1.08
LPT3535ER500LK	50	± 15 %	51.2	0.280	0.84	30.5 at 0.88
LPT3535ER101LK	100	± 15 %	101	0.514	0.63	60.2 at 0.63
LPT3535ER151LK	150	± 15 %	151	0.775	0.57	90.0 at 0.51
LPT3535ER251LK	250	± 15 %	252	1.279	0.40	150.0 at 0.40
LPT3535ER331LK	330	± 15 %	328	1.837	0.33	195.0 at 0.35
LPT3535ER1ROLP	1.0	± 15 %	0.882	0.004	5.10	0.56 at 4.29
LPT3535ER1R5LP	1.5	± 15 %	1.57	0.005	4.48	0.99 at 3.21
LPT3535ER2R5LP	2.5	± 15 %	2.45	0.009	3.58	1.54 at 2.57
LPT3535ER3R3LP	3.3	± 15 %	3.53	0.013	2.96	2.22 at 2.14
LPT3535ER5R0LP	5.0	± 15 %	4.80	0.018	2.41	3.03 at 1.84
LPT3535ER100LP	10	± 15 %	10.8	0.043	1.58	6.81 at 1.22
LPT3535ER150LP	15	± 15 %	15.3	0.064	1.29	9.65 at 1.03
LPT3535ER250LP	25	± 15 %	25.1	0.103	1.03	15.8 at 0.80
LPT3535ER330LP	33	± 15 %	33.5	0.147	0.85	21.1 at 0.70
LPT3535ER500LP	50	± 15 %	51.8	0.230	0.68	32.7 at 0.56
LPT3535ER101LP	100	± 15 %	104	0.424	0.51	65.2 at 0.40
LPT3535ER151LP	150	± 15 %	153	0.645	0.41	96.3 at 0.33
LPT3535ER251LP	250	± 15 %	250	1.031	0.33	157.0 at 0.25
LPT3535ER331LP	330	± 15 %	330	1.463	0.27	208.0 at 0.22
LPT3535ER1ROLM	1.0	± 15 %	0.800	0.005	6.45	0.52 at 7.05
LPT3535ER1R5LM	1.5	± 15 %	1.80	0.009	4.80	1.16 at 4.70
LPT3535ER2R5LM	2.5	± 15 %	2.45	0.011	4.46	1.58 at 4.03
LPT3535ER3R3LM	3.3	± 15 %	3.20	0.015	3.73	2.06 at 3.52
LPT3535ER5R0LM	5.0	± 15 %	5.00	0.023	3.02	3.22 at 2.82
LPT3535ER100LM	10	± 15 %	11.3	0.055	1.94	7.25 at 1.88
LPT3535ER150LM	15	± 15 %	16.2	0.081	1.59	10.43 at 1.57
LPT3535ER250LM	25	± 15 %	26.5	0.131	1.26	17.0 at 1.23
LPT3535ER330LM	33	± 15 %	33.8	0.182	1.05	21.8 at 1.08
LPT3535ER500LM	50	± 15 %	51.2	0.280	0.84	33.0 at 0.88
LPT3535ER101LM	100	± 15 %	101	0.514	0.64	97.4 at 0.51
LPT3535ER151LM	150	± 15 %	151	0.775	0.52	65.2 at 0.63
LPT3535ER251LM	250	± 15 %	252	1.279	0.40	162.0 at 0.51
LPT3535ER331LM	330	± 15 %	328	1.837	0.33	211.0 at 0.35

DESCRIPTION						
LPT	3535	100 μH	± 15 %	A	ER	e2
MODEL	SIZE	INDUCTANCE VALUE	INDUCTANCE TOLERANCE	CORE/HEIGHT K = KOOL MU [®] (A) P = POWDERED IRON (B) M = MPP (C)	PACKAGE CODE ER = Reel EB = Bulk	JEDEC LEAD (Pb)-FREE STANDARD

GLOBAL PART NUMBER													
L	P	T	3	5	3	5	E	R	1	0	1	L	K
PRODUCT FAMILY			SIZE			PACKAGE CODE		INDUCTANCE VALUE			TOL.	CORE	

Note

- Series is also available with SnPb terminations by using package code RH for tape and reel (in place of ER) or SM for bulk (in place of EB).

LPT-3535

Vishay Dale

Inductors/Transformers Customizable, Surface Mount
Torodial, Kool Mu[®], Powdered Iron and MPP Cores

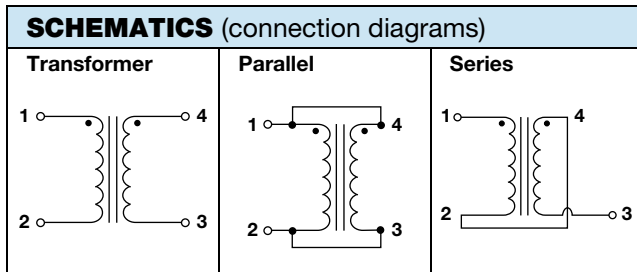
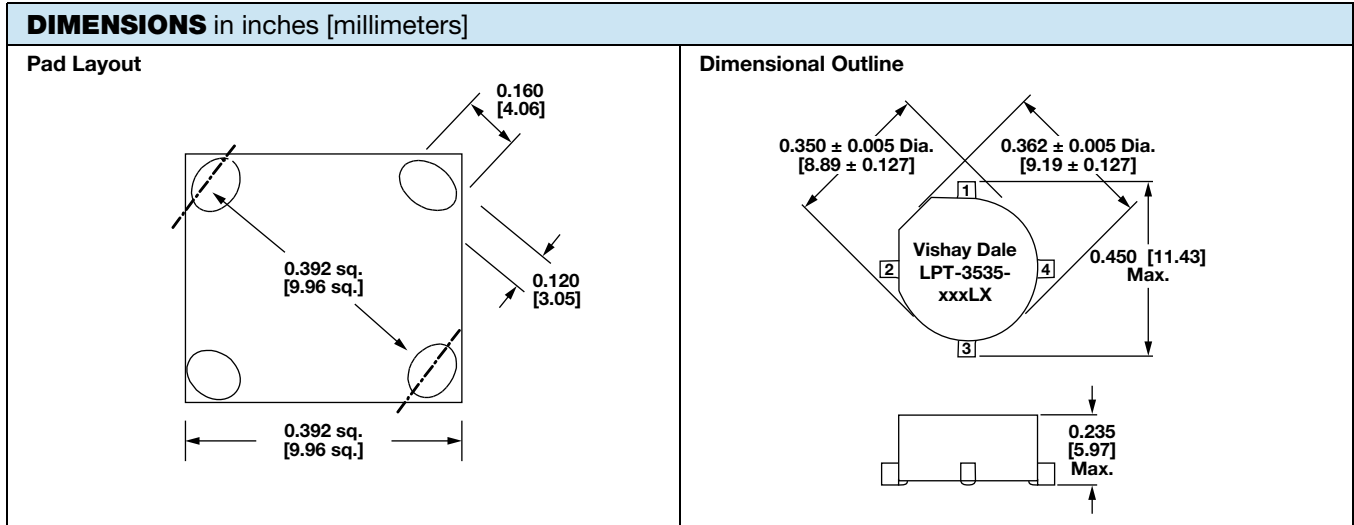

PART MARKING

- Vishay Dale
- Model number
- Pin 1 identification

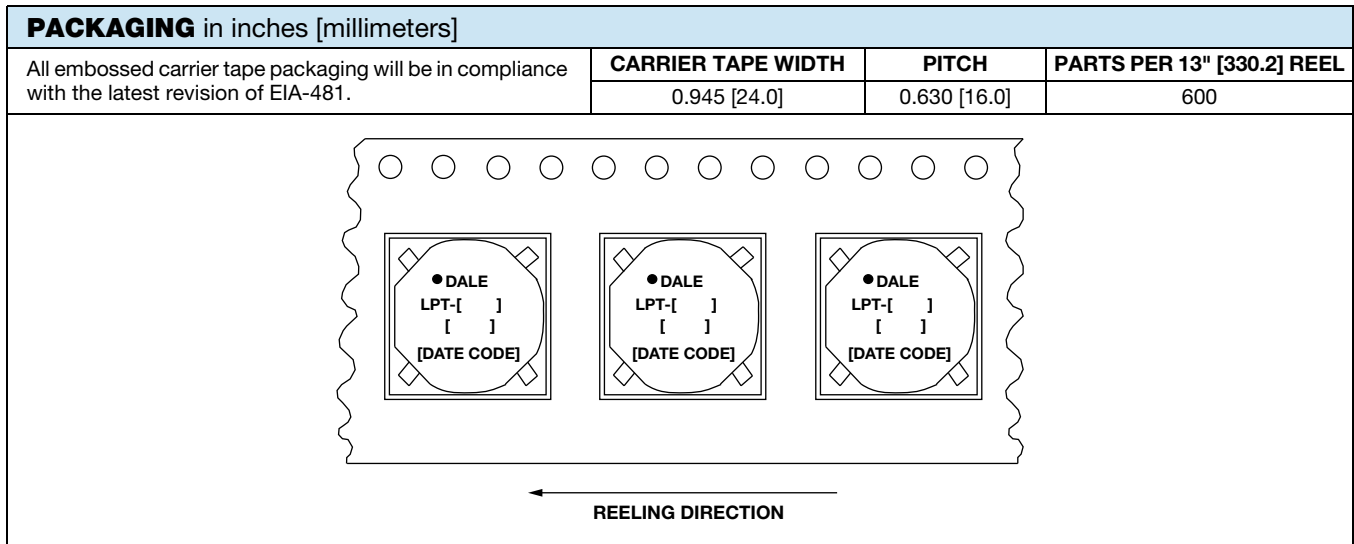

Inductors/Transformers Customizable, Surface Mount Torodial, Kool Mu[®], Powdered Iron and MPP Cores

Note

- Kool Mu[®] is a registered trademark of Spang & Company

FEATURES

- Toroidal design for minimal EMI radiation in DC/DC converter applications
- Designed to support the growing need for efficient DC/DC converters in battery operated equipment
- Two separate windings provide versatility by ability to connect windings in series or parallel
- Operating temperature range: - 40 °C to + 125 °C
- Supplied on tape and reel and is designed to be pick and place compatible
- Custom versions and turns ratios available. Contact the factory with your specifications
- Compliant to RoHS Directive 2002/95/EC
- Halogen-free according to IEC 61249-2-21 definition

**RoHS
COMPLIANT**
 HALOGEN
FREE

STANDARD ELECTRICAL SPECIFICATIONS (in parallel)								
MODEL	STD. IND. (μH)	IND. TOL.	ACTUAL IND. (LOC) (μH)	DCR (Ω)	RATED I _{DC} (40 °C)	IND. AT I _{DC} (L-BIAS) (30 %)		
LPT4545ER1ROLK	1.0	± 15 %	0.832	0.003	6.90	0.51 at 7.62	KOOL MU [®] CORE (A)	
LPT4545ER1R5LK	1.5	± 15 %	1.30	0.004	6.45	0.80 at 6.10		
LPT4545ER2R5LK	2.5	± 15 %	2.55	0.006	5.75	1.57 at 4.35		
LPT4545ER3R3LK	3.3	± 15 %	3.33	0.007	5.50	2.05 at 3.81		
LPT4545ER5R0LK	5.0	± 15 %	5.20	0.011	4.45	3.20 at 3.05		
LPT4545ER100LK	10	± 15 %	10.2	0.019	3.45	6.28 at 2.18		
LPT4545ER150LK	15	± 15 %	15.0	0.029	2.79	9.26 at 1.79		
LPT4545ER200LK	20	± 15 %	20.8	0.038	2.61	12.4 at 1.53		
LPT4545ER250LK	25	± 15 %	25.2	0.048	2.25	15.5 at 1.39		
LPT4545ER330LK	33	± 15 %	32.5	0.068	1.85	20.0 at 1.22		
LPT4545ER500LK	50	± 15 %	50.0	0.107	1.50	30.8 at 0.98		
LPT4545ER101LK	100	± 15 %	101	0.195	1.15	62.0 at 0.69		
LPT4545ER151LK	150	± 15 %	152	0.302	0.92	93.4 at 0.56		
LPT4545ER251LK	250	± 15 %	248	0.491	0.73	153.0 at 0.44		
LPT4545ER301LK	300	± 15 %	300	0.670	0.63	179.0 at 0.40		
LPT4545ER331LK	330	± 15 %	333	0.706	0.60	205.0 at 0.38		
LPT4545ER1ROLP	1.0	± 15 %	0.838	0.004	6.61	0.53 at 7.09	POWDERED IRON (B)	
LPT4545ER1R5LP	1.5	± 15 %	1.21	0.005	6.08	0.76 at 5.91		
LPT4545ER2R5LP	2.5	± 15 %	2.71	0.009	5.01	1.71 at 3.94		
LPT4545ER3R3LP	3.3	± 15 %	3.35	0.012	4.22	2.11 at 3.54		
LPT4545ER5R0LP	5.0	± 15 %	5.66	0.019	3.32	3.57 at 2.73		
LPT4545ER100LP	10	± 15 %	10.9	0.034	2.52	6.84 at 1.97		
LPT4545ER150LP	15	± 15 %	14.8	0.049	2.10	9.31 at 1.69		
LPT4545ER250LP	25	± 15 %	26.3	0.084	1.61	16.5 at 1.27		
LPT4545ER330LP	33	± 15 %	34.3	0.119	1.34	21.6 at 1.11		
LPT4545ER500LP	50	± 15 %	51.0	0.180	1.09	32.1 at 0.91		
LPT4545ER101LP	100	± 15 %	105	0.342	0.81	66.2 at 0.63		
LPT4545ER151LP	150	± 15 %	150	0.509	0.66	94.7 at 0.53		
LPT4545ER251LP	250	± 15 %	248	0.831	0.52	156.0 at 0.41		
LPT4545ER331LP	330	± 15 %	335	1.194	0.43	211.0 at 0.35		
LPT4545ER1ROLM	1.0	± 15 %	0.838	0.004	7.54	0.54 at 11.11		MPP (C)
LPT4545ER1R5LM	1.5	± 15 %	1.30	0.004	6.82	0.84 at 8.89		
LPT4545ER2R5LM	2.5	± 15 %	2.55	0.007	5.84	1.64 at 6.35		
LPT4545ER3R3LM	3.3	± 15 %	3.33	0.008	5.49	2.14 at 5.56		
LPT4545ER5R0LM	5.0	± 15 %	5.20	0.012	4.37	3.35 at 4.45		
LPT4545ER100LM	10	± 15 %	10.2	0.022	3.32	6.56 at 3.18		
LPT4545ER150LM	15	± 15 %	15.0	0.033	2.69	9.68 at 2.61		
LPT4545ER250LM	25	± 15 %	25.2	0.054	2.12	16.2 at 2.02		
LPT4545ER330LM	33	± 15 %	32.5	0.076	1.76	20.9 at 1.78		
LPT4545ER500LM	50	± 15 %	50.0	0.119	1.41	32.2 at 1.43		
LPT4545ER101LM	100	± 15 %	101	0.219	1.07	64.8 at 1.01		
LPT4545ER151LM	150	± 15 %	152	0.340	0.86	97.7 at 0.82		
LPT4545ER251LM	250	± 15 %	248	0.551	0.67	159.0 at 0.64		
LPT4545ER331LM	330	± 15 %	333	0.788	0.56	214.0 at 0.56		

DESCRIPTION						
LPT	4545	100 μH	± 15 %	A	ER	e2
MODEL	SIZE	INDUCTANCE VALUE	INDUCTANCE TOLERANCE	CORE/HEIGHT K = KOOL MU [®] (A) P = POWDERED IRON (B) M = MPP (C)	PACKAGE CODE ER = Reel EB = Bulk	JEDEC LEAD (Pb)-FREE STANDARD

GLOBAL PART NUMBER													
L	P	T	4	5	4	5	E	R	1	0	1	L	K
PRODUCT FAMILY			SIZE			PACKAGE CODE		INDUCTANCE VALUE			TOL.	CORE	

Note

- Series is also available with SnPb terminations by using package code RH for tape and reel (in place of ER) or SM for bulk (in place of EB).

LPT-4545

Vishay Dale

Inductors/Transformers Customizable, Surface Mount
Toroidal, Kool Mu[®], Powdered Iron and MPP Cores

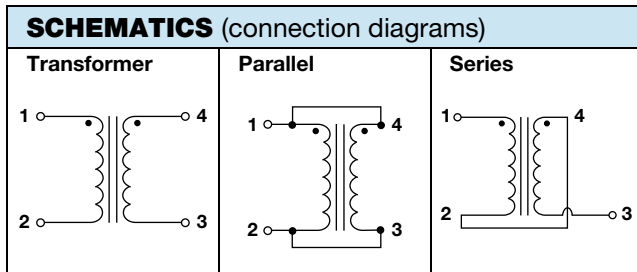
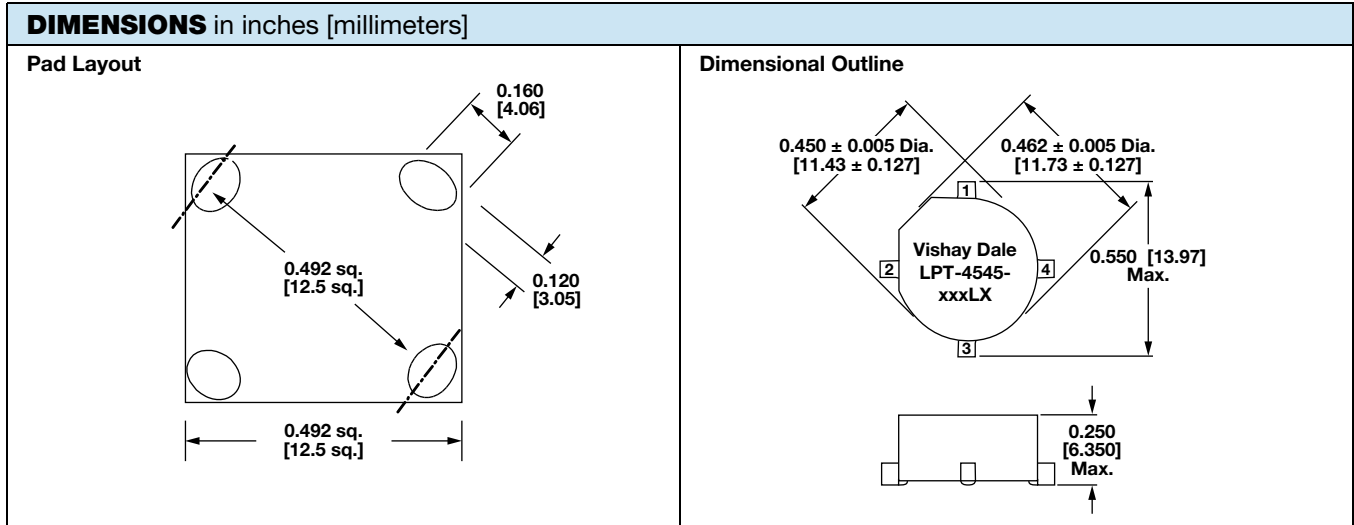

PART MARKING

- Vishay Dale
- Model number
- Pin 1 identification

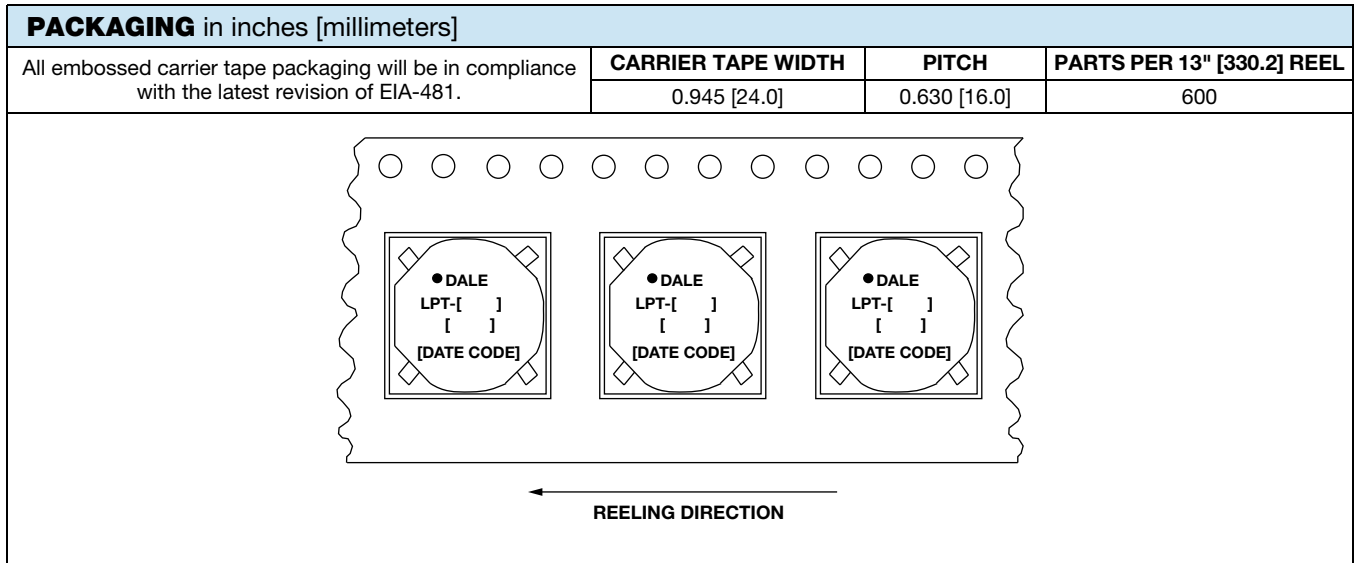



Reference Information

Contents

Custom Products.....	246
Definitions	254
Engineering Note ILB, ILBB, IMC, ISC, IFC.....	261
Engineering Note ILB, ILBB Ferrite Beads.....	268
Engineering Note	274
Packaging Methods.....	276
Conversion Tables	278
Linear Tech Cross Reference	279

Magnetic Components

SWITCH MODE MAGNETICS



CUSTOM DESIGN AND PRODUCTION

Vishay Dale has extensive facilities for custom design and production of custom magnetics. Design applications include:

- PWM, PSM and FM transformers
- Pulse and trigger transformers
- Test measurement transformers
- Power transformers
- Power, filter and switchmode inductors
- Telecommunications/audio transformers

Design input forms for the above design applications follow:

PACKAGE DESIGN AND MATERIALS

If you have your own electrical design we can add value by assisting you with selection of the most economical materials and efficient packaging design.

Vishay Dale can provide designs to meet UL, CSA, IEEE and VDE requirements.

Produced to your specifications for a wide range of high frequency applications including: Television, radio (2-way, scanners, AM/FM), satellite communication, cable TV systems, microwave, test equipment.

AIR CORE INDUCTORS



ELECTRICAL SPECIFICATIONS

Frequency: To 500 MHz

Current: 10 A maximum

Temperature: To + 130 °C

MECHANICAL SPECIFICATIONS

Winding: 1 to 32 turns, clockwise or counter-clockwise with variable pitch

Wire gauge: #18 to #32

Leads: Automatically tinned. Various configurations available

Coil inside diameter: 0.079" to 0.354" [2.01 mm to 8.99 mm]

Coil length: Up to 1.26" [32.0 mm]

Cannot find it in the catalog? Vishay Dale has the custom capability to design and produce a wide range of magnetic components to your requirements.

INDUCTIVE PRODUCTS



POWER TRANSFORMERS

50 Hz to 400 Hz, VA ratings to 100 VA. Specialty models in low profile and PC mount.

INDUCTORS

Inductance values to 20 H, current ratings to 60 A. Capability of many styles including: Toroidal, laminated, E core, pot core, slug core, air core

AUDIO TRANSFORMERS

Coupling transformers and hybrid transformers available in PC mount, leadset and low profile

TRANSFORMERS

Switching magnetics, converter transformers, pulse transformers, high voltage transformers



POWER TRANSFORMER DESIGN INFORMATION

CONTACT INFORMATION

Contact Person _____ E-Mail _____
Phone # _____ - _____ - _____ Fax # _____ - _____ - _____ Company _____
General Application of this product: _____

ELECTRICAL REQUIREMENTS

Approximate Output Power: _____ VA Duty Cycle: _____ %
Minimum Line Frequency (Hz): _____ Primary Input Voltage: _____
50 60 400 1K 100K 150K 250K Other: _____ 90 100 115 120 200 230 240 115/230 Other: _____
Maximum Temperature Rise (°C): _____ Protection (Resettable or Single Use): _____
10 20 30 40 50 Other: _____ Thermal Fused Other: _____
Efficiency: _____ % Regulation: _____ %
Isolation Voltage: _____ VAC/VDC Agency Requirements: UL VDE CSA IEC
Interwinding Capacitance (Ciw): _____ pF Leakage Ind. (LI): _____ μH

SCHEMATIC

Schematic diagram of a transformer with multiple secondary windings. Includes fields for Voltage, Current, L, Rect, and other requirements for each winding. Also includes fields for Screen or Shield, Outer Shield, Thick, and Material. Includes a Pin Requirements grid.

PHYSICAL REQUIREMENTS

Flame Retardant: Yes No Mounting Style:
Standard Varnish: Yes No Thru Hole Surface Mount Flying Leads Other _____
Encapsulated: Yes No Length (Max.): _____
Hermetically Sealed: Yes No Width (Max.): _____
Shielded: Yes/No Height (Max.): _____ Temperature Class (°C): _____
Grid Units: _____

105 130 155 180 200

OTHER REQUIREMENTS

PRIORITIZATION (1-HIGHEST)

_____ Size
_____ Efficiency
_____ Cost

(Continue on separate sheet if necessary)



POWER TRANSFORMER DESIGN INFORMATION

CONTACT INFORMATION

Contact Person _____ E-Mail _____
 Phone # _____ - _____ - _____ Fax # _____ - _____ - _____ Company _____
 General Application of this product: _____

ELECTRICAL REQUIREMENTS

Approximate Output Power: _____ VA Duty Cycle: _____ %
 Minimum Line Frequency (Hz): _____ Primary Input Voltage: _____
 50 60 400 1K 100K 150K 250K Other: _____ 90 100 115 120 200 230 240 115/230 Other: _____
 Maximum Temperature Rise (°C): _____ Protection (Resettable or Single Use): _____
 10 20 30 40 50 Other: _____ Thermal Fused Other: _____
 Efficiency: _____ % Regulation: _____ %
 Isolation Voltage: _____ V_{AC}/V_{DC} Agency Requirements: UL VDE CSA IEC
 Interwinding Capacitance (Ciw): _____ pF Leakage Ind. (LI): _____ μH

SCHEMATIC

Voltage: _____	◇		◇	Voltage: _____ AC or DC	Other Requirements: _____
Current: _____				Current: _____ RMS or Peak	_____
L: _____				Rect: _____ HW FW FWB	_____
Voltage: _____	◇			◇	Voltage: _____ AC or DC
Current: _____				Current: _____ RMS or Peak	_____
L: _____				Rect: _____ HW FW FWB	_____
Voltage: _____	◇		◇	Voltage: _____ AC or DC	Other Requirements: _____
Current: _____				Current: _____ RMS or Peak	_____
L: _____				Rect: _____ HW FW FWB	_____
Voltage: _____	◇		◇	Voltage: _____ AC or DC	Budgetary/Target Price: _____
Current: _____				Current: _____ RMS or Peak	_____ at _____ pcs
L: _____				Rect: _____ HW FW FWB	
Screen or Shield	◇		◇	Outer Shield	Pin Requirements
Thick: _____				Thick: _____	
Material: _____				Material: _____	

PHYSICAL REQUIREMENTS

Flame Retardant: Yes No Mounting Style: _____
 Standard Varnish: Yes No Thru Hole Surface Mount Flying Leads Other _____
 Encapsulated: Yes No Length (Max.): _____
 Hermetically Sealed: Yes No Width (Max.): _____
 Shielded: Yes No Height (Max.): _____ Temperature Class (°C): _____
 105 130 155 180 200

OTHER REQUIREMENTS

 _____ (Continue on separate sheet if necessary)

PRIORITIZATION (1-HIGHEST)

 _____ Size
 _____ Efficiency
 _____ Cost



POWER, FILTER AND SWITCHMODE INDUCTOR DESIGN INFORMATION

CONTACT INFORMATION

Contact Person _____ E-Mail _____
 Phone # _____ - _____ - _____ Fax # _____ - _____ - _____ Company _____
 General Application of this product: _____

Application: Power/Energie or Filter/Frequency Selection

ELECTRICAL REQUIREMENTS

L: _____ H
 DC Bias: _____ A_{DC}
 L at DC Bias: _____ H
 Q Min. at nominal L: _____
 % of Saturation (Max.): _____ %
 AC Current or Voltage Level: _____ A_{AC} or V_{AC}
 DC Current or Voltage Level: _____ A_{DC} or V_{DC}
 Impedance: _____ Ω at _____ Hz

Frequency (Range): _____ Hz
 SRF: _____ Hz
 ET: _____ V-μs
 DCR (Max.): _____ Ω
 Dielectric Range: _____ V_{AC}/V_{DC}
 Operating Temperature Range: _____ to _____
 Maximum Temperature Rise (°C): 10 20 30 40 50 _____

SCHEMATIC

Voltage: _____ AC or DC
 Current: _____ RMS or Peak
 Other: _____
 Voltage: _____ AC or DC
 Current: _____ RMS or Peak
 Other: _____
 Voltage: _____ AC or DC
 Current: _____ RMS or Peak
 Other: _____
 Voltage: _____ AC or DC
 Current: _____ RMS or Peak
 Other: _____
 Voltage: _____ AC or DC
 Current: _____ RMS or Peak
 Other: _____
 Screen or Shield
 Thick: _____
 Material: _____

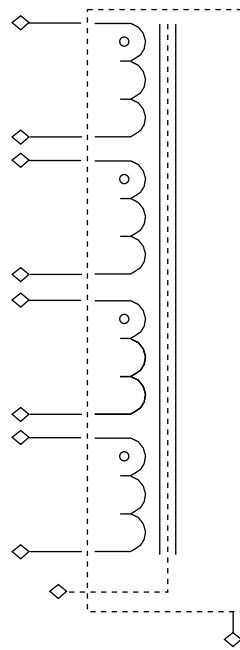

BUCK AND BOOST INDUCTORS

Input Voltage	_____ V
Output Voltage	_____ V
Switching Frequency	_____ Hz
Maximum DC Output Current	_____ A
Minimum DC Output Current	_____ A
Maximum Duty Cycle	_____ %
Minimum Duty Cycle	_____ %
AC Ripple	_____ %

Budgetary/Target Price:
 _____ at _____ pcs

Outer Shield
 Thick: _____
 Material: _____

Pin Requirements

PHYSICAL REQUIREMENTS

Flame Retardant: Yes No Mounting Style: Vertical or Horizontal
 Standard Varnish: Yes No Thru Hole Surface Mount Flying Leads Other _____
 Encapsulated: Yes No Inside Diameter (Min.): _____
 Hermetically Sealed: Yes No Length (Max.): _____
 Shielded: Yes No Width (Max.): _____ Temperature Class (°C): 105 130 155 180 200
 Height (Max.): _____

Grid Units: _____

OTHER REQUIREMENTS

 _____ (Continue on separate sheet if necessary)

PRIORITIZATION (1-HIGHEST)

 _____ Size
 _____ Efficiency
 _____ Cost



TELECOMMUNICATIONS/AUDIO TRANSFORMER DESIGN INFORMATION

CONTACT INFORMATION

Contact Person _____ E-Mail _____
Phone # _____ - _____ - _____ Fax # _____ - _____ - _____ Company _____
General Application of this product: _____

Application Type: Modem Audio xDSL

ELECTRICAL REQUIREMENTS

Power Rating: _____ W Frequency Range: _____ Hz to _____ Hz
Primary Voltage: _____ VAC/VDC Frequency Response: Ref. _____ Hz ± _____ db
Primary Impedance: _____ Ω from _____ Hz to _____ Hz
Secondary Impedance: _____ Ω Insertion/Transducer Loss: ± _____ db (Max.) or
Turns Ratio: _____ (if known) ± _____ db at _____ Hz
Isolation Voltage: _____ VAC or VDC Longitudinal Transverse Balance:
DC Loop Current: _____ mA DC _____ db (Min.) from _____ Hz to _____ Hz
Maximum Drive Level: _____ dbm VRMS _____ db (Min.) from _____ Hz to _____ Hz
Ref. Resistance: _____ Ω Crosstalk: _____ db or better from _____ Hz to
Return Loss: _____ db (Min.) _____ Hz w/ _____ spacing
Distortion: _____ % Maximum
Leakage L: _____ μH (Max.) Ciw: _____ pF (Max.) DCR: _____ Ω

SCHEMATIC

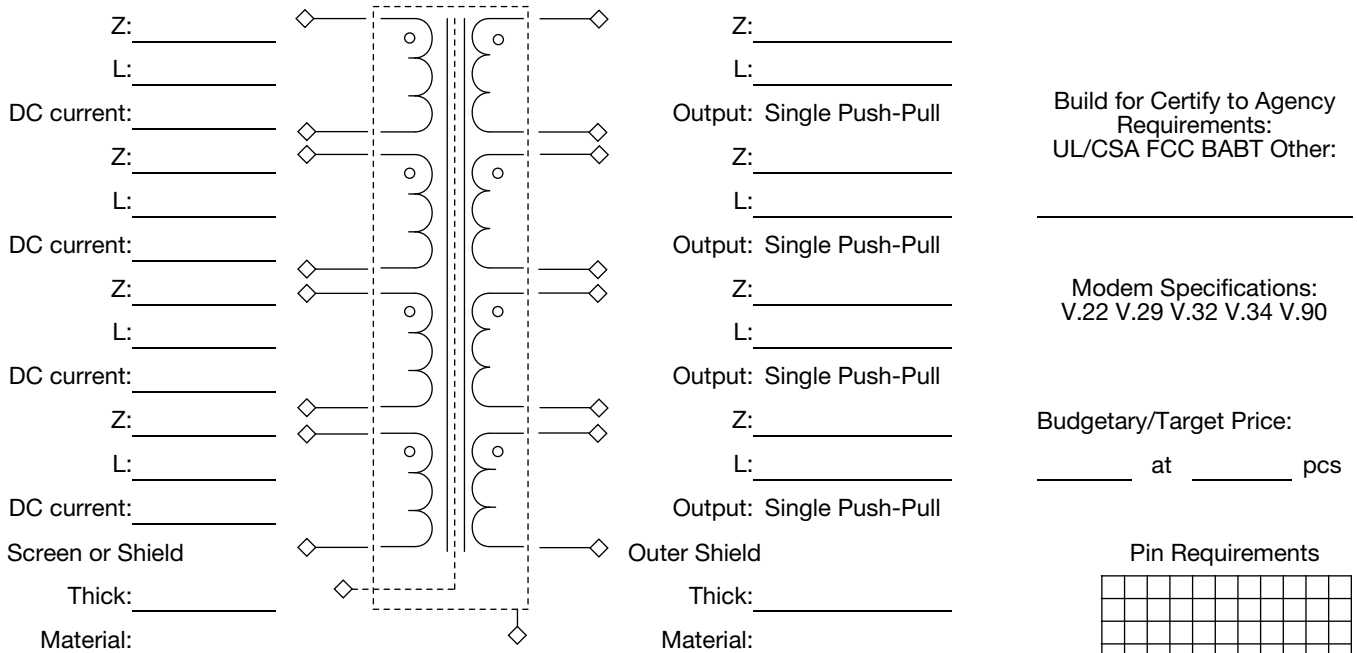

PHYSICAL REQUIREMENTS

Flame Retardant: Yes No Mounting Style:
Standard Varnish: Yes No Thru Hole Surface Mount Flying Leads Other _____
Encapsulated: Yes No Inside Diameter (Min.): _____
Hermetically Sealed: Yes No Length (Max.): _____
Shielded: Yes/No Width (Max.): Temperature Class (°C): Grid Units: _____
Height (Max.): _____ 105 130 155 180 200

OTHER REQUIREMENTS

PRIORITIZATION (1-HIGHEST)

____ Size
____ Efficiency
____ Cost
(Continue on separate sheet if necessary)

Pin Requirements grid table



CUSTOM DESIGN GRID

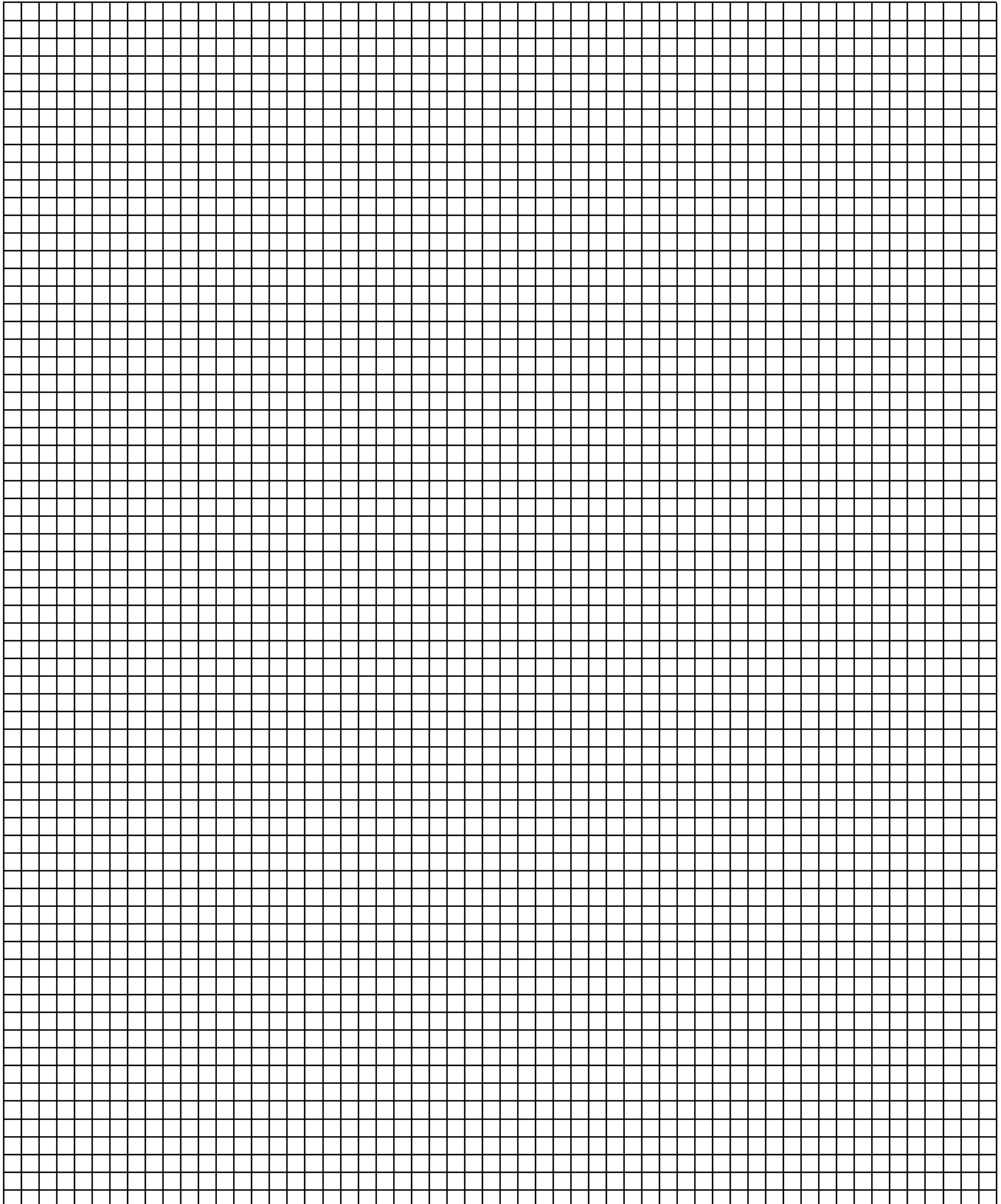

Inductor and Magnetic Product Terminology

INTRODUCTION

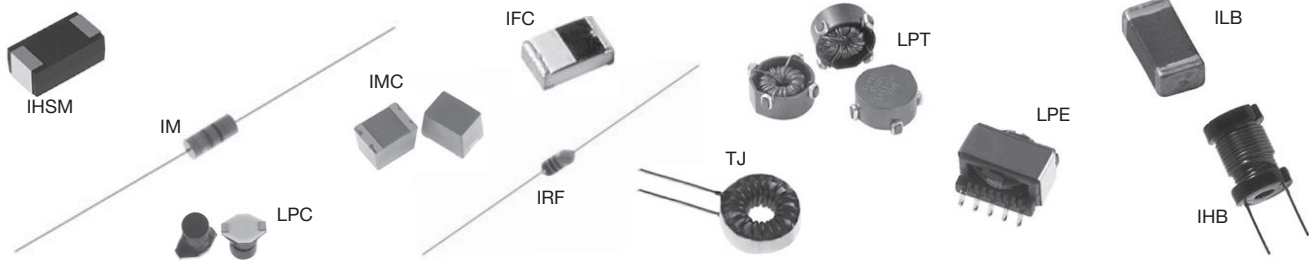

The scope of this application note is to define the terminology associated with inductors and their applications. Some of these terms are listed in the component data sheets. Many terms go beyond the specification of inductors. These terms describe issues associated with inductor design and performance, magnetic materials and theory and applications. A thorough understanding of these terms and definitions will aid in the selling, procurement and application of inductor products.

DEFINITIONS

AIR CORE INDUCTORS

(see Ceramic Core and Phenolic Core)

AMBIENT TEMPERATURE

The temperature of still air immediately surrounding a component or circuit. A typical method to measure ambient temperature is to record the temperature that is approximately 1/2" from the body of the component or circuit.

ATTENUATION

The relative decrease in amplitude of a given parameter. Attenuation measurements are common for voltage, current and power. It is usually expressed in units of decibels (dB). For a power ratio, one dB = $10 \text{ Log}_{10} (P_1/P_2)$.

A dB is equal to $20 \text{ Log}_{10} (I_1/I_2)$ for current and $20 \text{ Log}_{10} (V_1/V_2)$ for voltage ratios.

AXIAL INDUCTOR

An inductor constructed on a core with concentric leads on opposite ends of the core. Axial inductors are available for both power applications and RF applications, and are available in many core materials including the basic phenolic, ferrite and powdered iron types. Both rod and bobbin shapes are utilized. Axial inductors are very suitable for tape and reel packaging for auto placement. (see Inductor).

Axial Leaded Inductor



BOBBIN CORE

A core with the shape of a bobbin or spool which contains flanges. Bobbin cores are available with and without leads and in the axial and radial form. (see Axial Inductor and Radial Inductor)

Bobbins



Axial Leaded

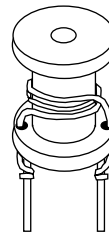

Radial Leaded

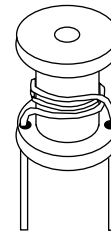

Leadless

BOOST REGULATOR (DC/DC)

A basic dc-to-dc switching converter topology that takes an unregulated input voltage, and produces a higher, regulated output voltage. This higher output voltage is achieved by storing energy in an input inductor and then transferring the energy to the output by turning a shunt switch (transistor) on and off.

Simplified Boost Regulator

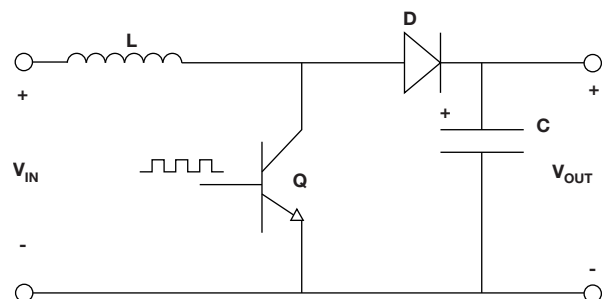

BUCK REGULATOR (DC/DC)

A basic DC/DC switching converter topology that takes an unregulated input voltage, and produces a lower, regulated output voltage. This output voltage is achieved by chopping the input voltage with a series connected switch (transistor) which applies pulses to an averaging inductor and capacitor circuit.

Simplified Buck Regulator

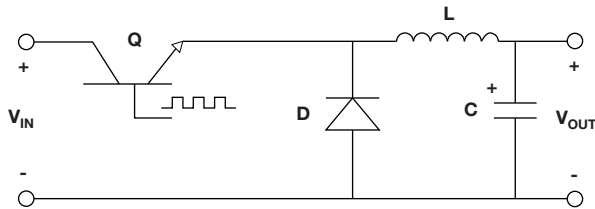

CERAMIC CORES

Ceramic is one of the common materials used for inductor cores. Its main purpose is to provide a form for the coil. In some designs it also provides the structure to hold the terminals in place. Ceramic has a very low thermal coefficient of expansion. This allows for relatively high inductance stability over the operating temperature ranges.

Ceramic has no magnetic properties. Thus, there is no increase in permeability due to the core material.

Ceramic core inductors are often referred to as “air core” inductors. Ceramic core inductors are most often used in high frequency applications where low inductance values, very low core losses and high Q values are required.

CHOKE

(see RF Choke)

CLOSED MAGNETIC PATH

Magnetic core shapes designed to contain all of the magnetic flux generated from an excited winding(s). Inductors made with these core types are considered to be shielded inductors. Shielding, however, is a matter of degree. Common core shapes that are considered to have closed magnetic paths are toroids, E-cores and most pot cores. Shielded bobbins also offer a high degree of shielding and may be considered to have closed magnetic paths for most practical purposes. Common core shapes that are considered to have open magnetic flux paths are rod cores and unshielded bobbin cores. (see Shielded Inductor)

COILS

Another common name for inductors. (see Inductor)

COLOR CODES

Inductor color codes have been standardized. The color marks or bands represent the inductor's value and tolerance. Following is a table that translates the colors and numbers:

COLOR CODE CHART			
COLOR	SIGNIFICANT FIGURES OR DECIMAL POINT	MULTIPLIER	INDUCTANCE TOLERANCE
Black	0	1	-
Brown	1	10	± 1 %
Red	2	100	± 2 %
Orange	3	1000	± 3 %
Yellow	4	10 000	± 4 %
Green	5	-	-
Blue	6	-	-
Violet	7	-	-
Gray	8	-	-
White	9	-	-
None	-	-	± 20 %
Silver	-	-	± 10 %
Gold	-	-	± 5 %

COMMON-MODE NOISE

Noise or electrical interference that is common to both electrical lines in relation to earth ground.

COPPER LOSS

The power lost by current flowing through the winding. The power loss is equal to the square of the current multiplied by the resistance of the wire (I^2R). This power loss is transferred into heat.

CORE LOSSES

Core losses are caused by an alternating magnetic field in the core material. The losses are a function of the operating frequency and the total magnetic flux swing. The total core losses are made up of three main components: Hysteresis, eddy current and residual losses. These losses vary considerably from one magnetic material to another. Applications such as higher power and higher frequency switching regulators and RF designs require careful core selection to yield the highest inductor performance by keeping the core losses to a minimum.

CORE SATURATION

(see Saturation Current)

CURIE TEMPERATURE

The temperature above which a ferrite core loses its magnetic properties. The core's permeability typically increases dramatically as the core temperature approaches the curie temperature which causes the inductance to increase. The permeability drops to near unity at the curie temperature which causes the inductance to drop dramatically. The curie point is the temperature at which the initial permeability has dropped to 10 % of its original value at room temperature.

DC/DC CONVERTER

A circuit or device that converts a DC input voltage to a regulated output voltage. The output voltage may be lower, higher or the same as the input voltage. Switching regulator DC/DC circuits most often require an inductor or transformer to achieve the regulated output voltage. Switching regulator circuits can achieve a higher level of power efficiency when compared to non-switching techniques. (see Boost Regulator and Buck Regulator)



DCR (DC RESISTANCE)

The resistance of the inductor winding measured with no alternating current. The DCR is most often minimized in the design of an inductor. The unit of measure is ohms, and it is usually specified as a maximum rating.

DIFFERENTIAL-MODE NOISE

Also known as normal-mode noise, it is electrical interference that is not common to both electrical lines but present between both electrical lines.

DISTRIBUTED CAPACITANCE

In the construction of an inductor, each turn of wire or conductor acts as a capacitor plate. The combined effects of each turn can be represented as a single capacitance known as the distributed capacitance. This capacitance is in parallel with the inductor. This parallel combination will resonate at some frequency which is called the self-resonant frequency (SRF). Lower distributed capacitances for a given inductance value will result in a higher SRF value for the inductor and vice versa. (see SRF)

EMI

EMI is an acronym for Electromagnetic Interference. It is unwanted electrical energy in any form. EMI is often used interchangeably with "Noise".

EDDY CURRENT LOSSES

Eddy current losses are present in both the magnetic core and winding of an inductor. Eddy currents in the winding (or conductor) contribute to two main types of losses: losses due to proximity effects and skin effects. As for the core losses, an electric field around the flux lines in the magnetic field is generated by alternating magnetic flux. This will result in eddy currents if the magnetic core material has electrical conductivity. Losses result from this phenomenon since the eddy currents flow in a plane that is perpendicular to the magnetic flux lines.

EPOXY COATED INDUCTOR

Inductors that have been coated with epoxy as opposed to having a molded case, shrink wrapped tubing or left with an open construction body. Epoxy coated inductors typically have smooth edges and surfaces. The epoxy coat acts as an insulation. Both radial and axial styles can be found with epoxy coated surfaces.

FERRITE CORE

Ferrite is a magnetic material which consists of a mixed oxide of iron and other elements that are made to have a crystalline molecular structure. The crystalline structure is created by firing the ferrite material at a very high temperature for a specified amount of time and profile. The general composition of ferrites is $x\text{Fe}_2\text{O}_4$ where xx represents one or several metals. The most popular metal combinations are manganese and zinc (MnZn) and nickel and zinc (NiZn). These metals can be easily magnetized.

FILTER

A circuit or device whose purpose is to control electrical energy at a given frequency or over a range of frequencies. Groups of passive components are commonly used to construct many types of filters. These passive components include resistors, capacitors and inductors.

IMPEDANCE

The impedance of an inductor is the total resistance to the

flow of current, including the AC and DC component. The DC component of the impedance is simply the DC resistance of the winding. The AC component of the impedance includes the inductor reactance. The following formula calculates the inductive reactance of an ideal inductor (i.e., one with no losses) to a sinusoidal AC signal.

$$Z = X_L = 2\pi fL$$

L is in henries and f is in Hertz. This equation indicates that higher impedance levels are achieved by higher inductance values or at higher frequencies. Skin effect and core losses also add to the impedance of an inductor. (see Skin Effect and Core Losses)

IMPEDANCE ANALYZER

Test instrument capable of measuring a wide range of impedance parameters, gain and phase angle. In testing inductors, impedance analyzers can measure inductance, Q, SRF, insertion loss, impedance and capacitance. They operate in a much more automatic fashion in comparison to Q Meters. Some impedance analyzers have a wider test frequency range than a Q meter.

INCREMENTAL CURRENT

The DC bias current flowing through the inductor which causes an inductance drop of 5 % from the initial zero DC bias inductance value. This current level indicates where the inductance can be expected to drop significantly if the DC bias current is increased further. This applies mostly to ferrite cores in lieu of powdered iron. Powdered iron cores exhibit "soft" saturation characteristics. This means their inductance drop from higher DC levels is much more gradual than ferrite cores. The rate at which the inductance will drop is also a function of the core shape. (see Saturation Current)

INDUCTANCE

The property of a circuit element which tends to oppose any change in the current flowing through it. The inductance for a given inductor is influenced by the core material, core shape and size, the turns count and the shape of the coil. Inductors most often have their inductances expressed in microhenries (μH). The following table can be used to convert units of inductance to microhenries. Thus, 47 mH would equal 47 000 μH .

$$\begin{aligned} 1 \text{ Henry (H)} &= 10^6 \mu\text{H} \\ 1 \text{ milli Henry (mH)} &= 10^3 \mu\text{H} \\ 1 \text{ micro Henry } (\mu\text{H}) &= 1 \mu\text{H} \\ 1 \text{ nano Henry (nH)} &= 10^{-3} \mu\text{H} \end{aligned}$$

INDUCTANCE TOLERANCE

Standard inductance tolerances are typically designated by a tolerance letter. Standard inductance tolerance letters include (see Color Codes):

LETTER	TOLERANCE
F	$\pm 1 \%$
G	$\pm 2 \%$
H	$\pm 3 \%$
J	$\pm 5 \%$
K	$\pm 10 \%$
L	$\pm 15 \%$ ⁽¹⁾
M	$\pm 20 \%$

Note

⁽¹⁾ L = $\pm 20 \%$ for some Military Products

INDUCTOR

A passive component designed to resist changes in current. Inductors are often referred to as “AC Resistors”. The ability to resist changes in current and the ability to store energy in its magnetic field, account for the bulk of the useful properties of inductors. Current passing through an inductor will produce a magnetic field. A changing magnetic field induces a voltage which opposes the field-producing current. This property of impeding changes of current is known as inductance. The voltage induced across an inductor by a change of current is defined as:

$$V = L \, di/dt$$

Thus, the induced voltage is proportional to the inductance value and the rate of current change. (see Inductance)

INPUT LINE FILTER

A power filter placed on the input to a circuit or assembly that attenuates noise introduced from the power bus. The filter is designed to reject noise within a frequency band. Typically these filters are low-pass filters meaning they pass low frequency signals such as the DC power and attenuate higher frequency signals which consist of mainly noise. Band pass or low pass filters are commonly made up of inductor and capacitor combinations. (also see Noise, Attenuation, EMI and Pi-Filter)

KOOL MU® CORE (1)

Kool Mu® is a magnetic material that has an inherent distributed air gap. The distributed air gap allows the core to store higher levels of magnetic flux when compared to other magnetic materials such as ferrites. This characteristic allows a higher DC current level to flow through the inductor before the inductor saturates.

Kool Mu material is an alloy that is made up of basically nickel and iron powder (approx. 50 % of each) and is available in several permeabilities. It has a higher permeability than powdered iron and also lower core losses. Kool Mu is required to be pressed at a much higher pressure than powdered iron material. The manufacturing process includes an annealing step that relieves the pressure put onto the powdered metals which restores their desirable magnetic properties. Thus, the powdered particles require a high temperature insulation as compared to powdered iron. Kool Mu performs well in power switching applications. The relative cost is significantly higher than powdered iron.

LAMINATED CORES

Cores constructed by stacking multiple laminations on top of each other. The laminations are offered in a variety of materials and thicknesses. Some laminations are made to have the grains oriented to minimize the core losses and give higher permeabilities. Each lamination has an insulated surface which is commonly an oxide finish. Laminated cores are used in some inductor designs but are more common in a wide variety of transformer applications.

LITZ WIRE

Wire consisting of a number of separately insulated strands that are woven or bunched together such that each strand tends to take all possible positions in the cross section of the wire as a whole. The current through each individual strand is divided equally since this wire design equalizes the flux linkages and reactance of the individual strands.

Note

(1) Kool Mu® is a registered trademark of Spang & Company

In other words, a Litz conductor has lower AC losses than comparable solid wire conductors which becomes important as the operating frequency increases. (see Skin Effect)

MAGNETIC WIRE

Wire used to create a magnetic field such as those in magnetic components (inductors and transformers). Magnet wire is nearly 100 % copper and must be made from virgin copper. It is offered with a number of different organic polymer film coatings.

MATCHED IMPEDANCE

The condition that exists when two coupled circuits are adjusted so that the output impedance of one circuit equals the input impedance of the other circuit connected to the first. There is a minimum power loss between two circuits when their connecting impedances are equal.

MOLDED INDUCTOR

An inductor whose case has been formed via a molding process. Common molding processes include injection and transfer molding. Molded inductors typically have well defined body dimensions which consist of smooth surfaces and sharper corners as compared to other case types such as epoxy coated and shrink wrap coatings. (see Inductor)

MONOLITHIC INDUCTOR

(see Multilayer Inductor)

MPP CORE

MPP is an acronym for molypermalloy powder. It is a magnetic material that has an inherent distributed air gap. The distributed air gap allows the core to store higher levels of magnetic flux when compared to other magnetic materials such as ferrites. This characteristic allows a higher DC current level to flow through the inductor before the inductor saturates.

The basic raw materials are nickel, iron and molybdenum. The ratios are: approximately 80 % nickel, 2 % to 3 % molybdenum, and the remaining is iron. The manufacturing process includes an annealing step as discussed in the Kool Mu definition. MPP stores higher amounts of energy and has a higher permeability than Kool Mu.

Cores are offered in 10 or more permeability selections. The core characteristics allow inductors to perform very well in switching power applications. Since higher energy can be stored by the core, more DC current can be passed through the inductor before the core saturates. The cost of MPP is significantly higher than Kool Mu, powdered irons and most ferrite cores with similar sizes. (see Saturation Current)

MULTILAYER INDUCTOR

An inductor constructed by layering the coil between layers of core material. The coil typically consists of a bare metal material (no insulation). This technology is sometimes referred to as “non-wirewound”. The inductance value can be made larger by adding additional layers for a given spiral pattern.

NOISE

Unwanted electrical energy in a circuit that is unrelated to the desired signal. Sources of noise are most often generated by some type of switching circuit. Common sources include switching voltage regulators and clocked signals such as digital circuits.

OHM

The unit of measurement for resistance and impedance. Resistance is calculated by Ohm's Law:

$$R = V/I \quad \text{where } R = \text{Resistance}$$

V = Voltage
I = Current

OPERATING TEMPERATURE RANGE

Range of ambient temperatures over which a component can be operated safely. The operating temperature is different from the storage temperature in that it accounts for the component's self temperature rise caused by the winding loss from a given DC bias current. This power loss is referred to as the "copper" loss and is equal to:

$$\text{Power Loss} = (\text{DCR}) (I_{\text{DC}}^2)$$

This power loss results in an increase to the component temperature above the given ambient temperature. Thus, the maximum operating temperature will be less than the maximum storage temperature:

$$\text{Maximum Operating Temperature} = \text{Storage Temperature} - \text{Self Temperature Rise}$$

(see Core Losses)

PERMEABILITY (CORE)

The permeability of a magnetic core is the characteristic that gives the core the ability to concentrate lines of magnetic flux. The core material, as well as the core geometry, affect the core's "effective permeability". For a given core shape, size and material, and a given winding, higher permeability magnetic materials result in higher inductance values as opposed to lower permeability materials.

PHENOLIC CORE

Phenolic is a common material used for inductor cores. Many are made of a polyester base that have high temperature characteristics. It is also common for phenolic cores to have high flammability ratings such as UL 94 V-0. Phenolic cores also provide high strength and are more economical than ceramic cores.

Phenolic has no magnetic properties. Thus, there is no increase in permeability due to the core material.

Phenolic core inductors are often referred to as "air core" inductors and are most often used in high frequency applications where low inductance values, very low core losses and high Q values are required.

PI-FILTER

A filter consisting of two capacitors connected in parallel with a series inductor. These filters are commonly found near dc-to-dc converters to filter ripple current and voltage.

Basic Pi-Filter

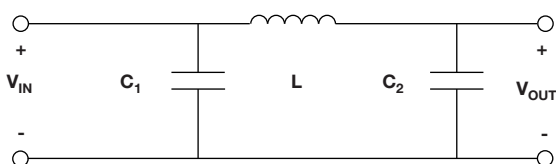

POLYOLEFIN TUBING

A common shrink wrap (tubing) used in the electronic industry. It is often used to provide insulation or protect wire insulation such as coil windings. Polyolefin tubing is a polymer which can be provided to meet various degrees of flammability requirements.

POWERED IRON CORE

Powdered iron is a magnetic material that has an inherent distributed air gap. The distributed air gap allows the core to store higher levels of magnetic flux when compared to other magnetic materials such as ferrites. This characteristic allows a higher DC current level to flow through the inductor before the inductor saturates.

Powdered iron cores are made of nearly 100 % iron. The iron particles are insulated from each other, mixed with a binder (such as phenolic or epoxy) and pressed into the final core shape. The cores are cured via a baking process. Other characteristics of powdered iron cores include: they are typically the lowest cost alternative and their permeabilities typically have a more stable temperature coefficient than ferrites. (see Saturation Current)

Q

The Q value of an inductor is a measure of the relative losses in an inductor. The Q is also known as the "quality factor" and is technically defined as the ratio of inductive reactance to effective resistance and is represented by:

$$Q = \frac{X_L}{R_e} = \frac{2\pi fL}{R_e}$$

Since X_L and R_e are functions of frequency, the test frequency must be given when specifying Q. X_L typically increases with frequency at a faster rate than R_e at lower frequencies, and vice versa at higher frequencies. This results in a bell shaped curve for Q vs. frequency. R_e is mainly comprised of the DC resistance of the wire, the core losses and skin effect of the wire.

Based on the above formula, it can be shown that the Q is zero at the self resonant frequency since the inductance is zero at this point.

Q METER

A standard instrument used to measure the inductance and Q of small RF inductors. The Q meter is based on a stable, continuously variable oscillator and a resonant circuit which is connected to the part to be tested.

The Q is proportional to the voltage across the internal calibrated variable capacitor. The voltage is measured by an internal RF Voltmeter. The capable test frequency range is near 22 kHz to 70 MHz.

RF CHOKE

Another name for a radio frequency inductor which is intended to filter or choke out signals. (see Inductor)

RFI

RFI is an acronym for Radio-Frequency Interference. It is an older and more restrictive term that is used interchangeably with "EMI". (see EMI)

RADIAL INDUCTOR

An inductor constructed on a core with leads exiting from the same side of the inductor body as to be mounted in the same plane. Radial inductors most often refer to two lead devices but technically include devices with more than two leads as well. Some common core shapes include rod cores, bobbins and toroids. (see Inductor)

Radial Inductor Styles

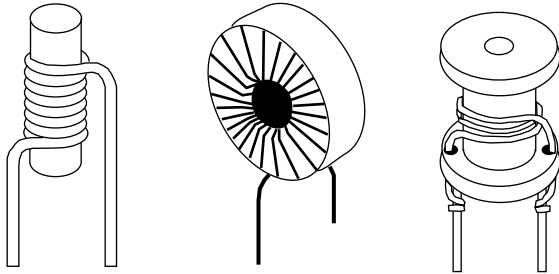

RATED CURRENT

The level of continuous DC current that can be passed through the inductor. This DC current level is based on a maximum temperature rise of the inductor at the maximum rated ambient temperature. The rated current is related to the inductor's ability to minimize the power losses in the winding by having a low DC resistance. It is also related to the inductor's ability to dissipate this power lost in the windings. Thus, the rated current can be increased by reducing the DC resistance or increasing the inductor size.

For low frequency current waveforms, the RMS current can be substituted for the DC rated current. The rated current is not related to the magnetic properties of the inductor. (see Incremental Current and Saturation Current)

REACTANCE

The imaginary part of the impedance. (see Impedance)

RIPPLE VOLTAGE

The periodic alternating voltage imposed on the voltage output of a switching voltage converter. The ripple voltage is normally specified as a peak-to-peak value.

SATURATION CURRENT

The DC bias current flowing through the inductor which causes the inductance to drop by a specified amount from the initial zero DC bias inductance value. Common specified inductance drop percentages include 10 % and 20 %. It is useful to use the 10 % inductance drop value for ferrite cores and 20 % for powdered iron cores in energy storage applications.

The cause of the inductance to drop due to the DC bias current is related to the magnetic properties of the core. The core, and some of the space around the core, can only store a given amount of magnetic flux density.

Beyond the maximum flux density point, the permeability of the core is reduced. Thus, the inductance is caused to drop. Core saturation does not apply to "air-core" inductors. (see Incremental Current and Permeability)

SRF (SELF-RESONANT FREQUENCY)

The frequency at which the inductor's distributed capacitance resonates with the inductance. It is at this frequency that the inductance is equal to the capacitance and they cancel each other. The inductor will act purely resistive with a high impedance at the SRF point.

The distributed capacitance is caused by the turns of wire layered on top of each other and around the core. This capacitance is in parallel to the inductance. At frequencies above the SRF, the capacitive reactance of the parallel combination will become the dominant component.

Also, the Q of the inductor is equal to zero at the SRF point since the inductive reactance is zero. The SRF is specified in MHz and is listed as a minimum value on product data sheets. (also see Distributed Capacitance)

SHIELDED INDUCTOR

An inductor designed for its core to contain a majority of its magnetic field. Some inductor designs are self shielding. Examples of these are magnetic core shapes which include toroids, pot cores and E-cores. Magnetic core shapes such as slug cores and bobbins require the application of a magnetic sleeve or similar method to yield a shielded inductor.

It should be noted that magnetic shielding is a matter of degree. A certain percentage of the magnetic field will escape the core material. This is even applicable for toroidal cores as lower core permeabilities will have higher fringing fields than will high permeability toroidal cores. (see Closed Magnetic Path)

SKIN EFFECT

Skin effect is the tendency for alternating current to flow near the surface of the conductor in lieu of flowing in a manner as to utilize the entire cross-sectional area of the conductor. This phenomenon causes the resistance of the conductor to increase. The magnetic field associated with the current in the conductor causes eddy currents near the center of the conductor which opposes the flow of the main current near the center of the conductor. The main current flow is forced further to the surface as the frequency of the alternating current increases. (see Litz Wire)

SLUG CORE

A core with the shape of a cylindrical rod. Slug cores typically refer to cores with no leads. Axial lead slug cores are very common. Non-leaded slug cores are typically used in power filtering applications. They exhibit higher flux density characteristics than other core shapes as most of the magnetic energy is stored in the air around the core. (see Axial Inductors and Radial Inductors)

Slug Cores

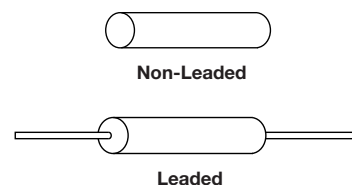

STORAGE TEMPERATURE RANGE

Range of ambient temperatures over which a component can be stored safely. (see Operating Temperature Range)

SWITCHING FREQUENCY

The operating frequency of a switching regulator.

SWITCHING REGULATOR

A circuit that is designed to regulate the output voltage, from a given input voltage, by using a closed control loop design. The most common switching regulator types involve a magnetic component, such as an inductor or transformer, that is used to store and transfer energy to the output by having the current switched on and off. (see Boost Regulator and Buck Regulator)

TAPE WOUND CORES

Cores made by rolling strips of alloy iron into a toroidal shape. The metal strips have a precisely controlled thickness which are coated with a very thin insulation material to prevent the metal in the layers to make contact with each other. The finished cores have an outside coating to protect the metal layers and they are offered in a variety of material mixes. Tape wound cores are capable of storing high amounts of energy and contain a high permeability. Their major disadvantage is that they are relatively expensive when compared to other core types. (see Toroidal Inductor)

TEMPERATURE RISE

The increase in surface temperature of a component in air due to the power dissipation in the component. The power dissipation for an inductor includes both copper and core losses.

TOROIDAL INDUCTOR

An inductor constructed by placing a winding(s) on a core that has a donut shaped surface. Toroidal cores are available in many magnetic core materials within the four basic types: Ferrite, powdered iron, alloy and high flux and tape wound. Characteristics of toroidal inductors include: self shielding (closed magnetic path), efficient energy transfer, high coupling between windings and early saturation.

Toroidal Inductors

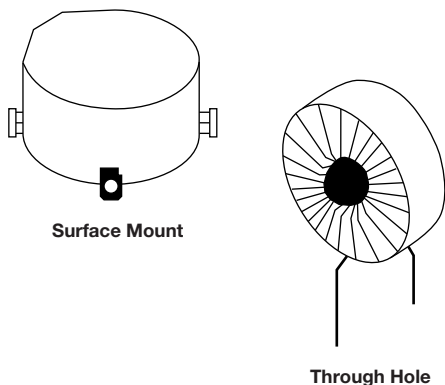

TEST FREQUENCY

The frequency at which inductors are tested for either inductance or Q or both. Some test frequencies used widely in the industry include:

COMMON TEST FREQUENCIES	
TEST FREQUENCY	INDUCTOR/VALUE MEASURED
1 kHz	Power Inductors (wide value range)
0.079 MHz	RF Inductors (above 10 000 μ H to 100 000 μ H)
0.250 MHz	RF Inductors (above 1000 μ H to 10 000 μ H)
0.790 MHz	RF Inductors (above 100 μ H to 1000 μ H)
2.5 MHz	RF Inductors (above 10 μ H to 100 μ H)
7.9 MHz	RF Inductors (above 1 μ H to 10 μ H)
25 MHz	RF Inductors (above 0.10 μ H to 1 μ H)
50 MHz	RF Inductors (0.01 μ H to 0.1 μ H)

Most of these test frequencies have been designated by military specifications. However, there are some conflicting frequency assignments among the military specifications. There is a present trend to assign test frequencies that match the user frequencies. This is particularly true for very low values. These user frequencies do not match those listed above.

VOLT MICROSECOND CONSTANT

The product of the voltage applied across the winding and the time for the magnetizing current to reach 1.5 times the linear extrapolation of the current waveform. This constant is a measure of the energy handling capability of a transformer or inductor. It is dependent upon the core area, core material (including the saturation flux density of the core), the number of turns of the winding and the duty cycle of the applied pulse.

VOLUME RESISTIVITY (CORE)

The ability of a core to resist the flow of electrical current either through the bulk of the material or on its surface. The unit of the volume resistivity is Ω /cm.

Core volume resistivity becomes an issue in inductor designs where the leads/terminals come in contact with the core material. This type includes axial and radial inductors that have leads epoxied into the core. As for core materials, high permeability ferrites present the most concern as their volume resistivity is typically the lowest.

Under certain conditions, a low resistive path can be realized between two inductor terminals if they are in contact with a low resistivity core. The inductor, under these conditions, will lose its higher impedance characteristics.



Circuit Simulation of Surface Mount Inductors and Impedance Beads

INTRODUCTION

With the advent of higher component densities, smaller components, and reduced design to market times, many of today's complex circuits are designed using a computer and circuit simulation software rather than actual physical breadboarding.

Inductors can be one of the most difficult passive components to accurately simulate, due to their inherent parasitic capacitive and resistive elements. These parasitic elements are the result of the resistance and turn-to-turn capacitance of the current conductor, which will affect the characteristic impedance of the inductor, particularly at higher frequencies. Figure 1 illustrates the equivalent circuit model for a real inductor with parasitic elements.

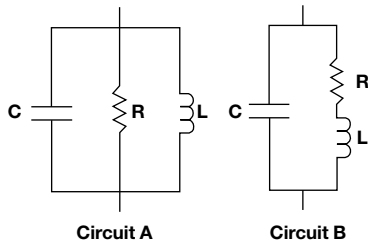

Fig. 1 - Equivalent Circuit for a Real Inductor

SIMULATING THE PERFORMANCE OF AN INDUCTOR

In many computer based circuit simulators, if a single element inductor is placed in the circuit, it will be represented as an ideal inductor. This may be acceptable if the simulation is at a frequency well below the series resonant frequency (SRF) of the inductor, as the impedance curve for the ideal and the real inductors are identical over frequency until a point that is about 20 % of the inductor's SRF. At this point, the impedance curves diverge due to the effects of the parasitic elements.

However, the accuracy of the ideal inductor model will begin to increase beyond 20 % of the inductor's SRF.

Figure 2 is a graph of the impedance versus frequency characteristics of a real and ideal inductor.

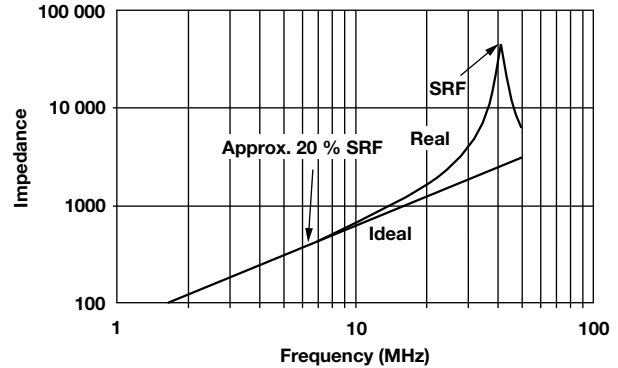

Fig. 2 - Impedance/Frequency Curves of Real and Ideal 10 µH Inductor

Most inductors can be represented with an acceptable degree of accuracy by one of the circuits shown in Figure 1. Circuit A typically represents an inductor that uses a magnetic core material such as ferrite or powdered iron. Circuit B will accurately represent most non-magnetic core inductors commonly referred to as "air cores." If the equivalent circuit values of the parasitic capacitance and resistance are known along with the effective inductance, the inductor model can be inserted in the circuit simulator and provide an accurate representation of the inductor's true performance in the A circuit.

Vishay Dale has generated the equivalent circuit values for many of its surface mount product lines. A table illustrating the equivalent circuit values for each of the current Vishay Dale product lines follows this discussion.

LIMITATIONS OF INDUCTOR MODELS

Most inductors are used well below their series resonant frequency (SRF) and these basic, three element inductor models will be very accurate under these simulation conditions. The SRF of the inductor occurs when the inductive reactance (X_L) is equal to the capacitive reactance (X_C) of the conductor. The impedance of the inductor is at its maximum and would be infinite if there were no core loss or if the resistance of the conductor were zero. Above the SRF, the X_C exceeds X_L and the inductor behaves like a capacitor. As the frequency increases above the SRF point, the inductor will go through several more resonant phases as a result of secondary parasitic elements which require a more complex equivalent circuit. For this reason, the typical useful range for the three element inductor models is the SRF of the inductor plus about 25 %.

IMC-0402				
NOMINAL INDUCTANCE (nH)	EQUIVALENT CIRCUIT DATA			
	CIRCUIT	RESISTANCE (Ω)	CAPACITANCE (pF)	INDUCTANCE (nH)
1.2	B	75.790	2.12680	0.896
1.5	B	50.568	1.48730	1.254
1.8	B	69.254	1.32050	1.469
2.2	B	72.762	0.91637	2.115
2.7	B	79.357	0.82001	2.356
3.3	B	87.174	0.66923	2.929
3.9	B	86.272	0.57138	3.452
4.7	B	123.660	0.47681	4.150
5.6	B	143.730	0.38200	5.255
6.8	B	171.930	0.31975	6.376
8.2	B	230.000	0.28377	7.329
10.0	B	213.970	0.23723	8.904
12.0	B	312.950	0.19187	11.175
18.0	B	554.440	0.13639	16.818
33.0	B	792.650	0.08367	30.769
39.0	B	1.059	0.07628	35.933
47.0	B	1.832	0.06090	45.300
56.0	B	1.987	0.05267	54.122

IMC-0603				
NOMINAL INDUCTANCE (nH)	EQUIVALENT CIRCUIT DATA			
	CIRCUIT	RESISTANCE (Ω)	CAPACITANCE (pF)	INDUCTANCE (nH)
1.5	B	0.0319	0.0000	1.34
1.8	B	0.0485	0.0000	1.65
2.2	B	0.0557	0.0000	1.98
2.7	B	0.0554	0.0125	2.52
3.3	B	0.0374	0.0118	3.15
3.9	B	0.0541	0.0232	3.68
4.7	B	0.0834	0.0362	4.40
5.6	B	0.1197	0.0439	5.46
6.8	B	0.1209	0.0486	6.54
8.2	B	0.1256	0.0515	7.82
10.0	B	0.1806	0.0555	9.64
12.0	B	0.2173	0.0620	11.55
15.0	B	0.2812	0.0630	14.64
18.0	B	0.3140	0.0647	17.45
22.0	B	0.3322	0.0698	21.26
27.0	B	0.4009	0.0683	25.98
33.0	B	0.5273	0.0740	31.95
39.0	B	0.5809	0.0694	37.29
47.0	B	0.7227	0.0723	45.30
56.0	B	0.9117	0.0667	53.70
68.0	B	1.0948	0.0717	63.19
82.0	B	1.4347	0.0684	76.62
100.0	B	1.5531	0.0709	93.26



Engineering Note ILB, ILBB, IMC, ISC, IFC

Circuit Simulation of Surface Mount Inductors
and Impedance Beads

Vishay Dale

IMC-0805-01				
NOMINAL INDUCTANCE (nH)	EQUIVALENT CIRCUIT DATA			
	CIRCUIT	RESISTANCE (Ω)	CAPACITANCE (pF)	INDUCTANCE (nH)
3.9	B	0.0884	0.0075	4.3
4.7	B	0.0958	0.0061	4.6
5.6	B	0.1053	0.0325	5.5
6.8	B	0.1297	0.0320	5.2
8.2	B	0.1472	0.0398	8.1
10	B	0.1468	0.1445	11.2
12	B	0.1749	0.0598	12.6
15	B	0.1861	0.0836	16.4
18	B	0.2194	0.0698	18.8
22	B	0.2420	0.0837	22.4
27	B	0.2638	0.0921	27.4
33	B	0.2814	0.1046	33.4
39	B	0.3282	0.0924	39.0
47	B	0.3432	0.0975	45.3
56	B	0.4023	0.0927	55.7
68	B	0.4356	0.0936	67.9
82	B	0.4880	0.1503	79.8
100	B	0.5968	0.0968	94.4
120	B	0.7235	0.1994	97.7
150	B	1.1647	0.1295	132.9
180	B	1.2414	0.1698	150.2
220	B	1.3983	0.1719	194.2
270	A	17.7K	0.4812	230.6
330	A	16.4K	0.5637	274.2
390	A	12.6K	0.8714	331.9
470	A	10.5K	1.5701	425.7
560	A	10.9K	1.2488	491.0
680	A	12.1K	1.3662	592.1
820	A	13.5K	1.1962	737.5
1000	A	12.5K	1.4749	859.1

IMC-1210				
NOMINAL INDUCTANCE (μH)	EQUIVALENT CIRCUIT DATA			
	CIRCUIT	RESISTANCE (Ω)	CAPACITANCE (pF)	INDUCTANCE (H)
0.010	B	89.79 m	0.0984	6.83 n
0.012	B	107.98 m	0.0965	9.09 n
0.015	B	119.35 m	0.1285	11.09 n
0.018	B	138.90 m	0.1390	14.62 n
0.022	B	135.92 m	0.1827	18.48 n
0.027	B	172.43 m	0.2258	22.37 n
0.033	B	218.71 m	0.1876	30.59 n
0.039	B	209.12 m	0.2440	35.42 n
0.047	B	215.71 m	0.2882	37.57 n
0.056	B	308.05 m	0.3251	46.38 n
0.068	B	224.86 m	0.3369	54.42 n
0.082	B	359.50 m	0.2936	63.2 n

IMC-1210				
NOMINAL INDUCTANCE (μH)	EQUIVALENT CIRCUIT DATA			
	CIRCUIT	RESISTANCE (Ω)	CAPACITANCE (pF)	INDUCTANCE (H)
0.100	B	353.36 m	0.3709	80.52 n
0.120	B	363.80 m	0.5019	103.4 n
0.150	B	229.68 m	0.6020	139.55 n
0.180	B	312.54 m	0.6353	159.31 n
0.220	B	269.10 m	0.7814	205.23 n
0.270	A	5.98 k	0.6474	253.82 n
0.330	A	4.11 K	0.6869	309.87 n
0.390	A	4.59 K	0.7050	375.18 n
0.470	A	7.48 K	0.7929	439.72 n
0.560	A	9.09 K	0.9563	523.33 n
0.680	A	10.66 K	0.8764	646.61 n
0.820	A	11.24 K	0.7070	751.05 n
1.0	A	14.21 K	1.2100	0.99 μ
1.2	A	13.73 K	0.9900	1.15 μ
1.5	A	15.51 K	1.5800	1.46 μ
1.8	A	18.89 K	1.4300	1.72 μ
2.2	A	20.98 K	1.1200	2.11 μ
2.7	A	25.90 K	0.9800	2.66 μ
3.3	A	24.65 K	1.5200	3.16 μ
3.9	A	27.80 K	1.6900	3.67 μ
4.7	A	26.43 K	1.4100	4.5 μ
5.6	A	35.52 K	1.3400	5.28 μ
6.8	A	38.26 K	1.5700	6.32 μ
5.2	A	37.93 K	1.3500	7.52 μ
10.0	A	46.21 K	1.5200	9.43 μ

IMC-1210-100				
NOMINAL INDUCTANCE (μH)	EQUIVALENT CIRCUIT DATA			
	CIRCUIT	RESISTANCE (Ω)	CAPACITANCE (pF)	INDUCTANCE (H)
0.010	B	64.1	0.1357	9.9 n
0.012	B	88.7	0.1463	11.8 n
0.015	B	130.7	0.1746	14.6 n
0.018	B	143.7	0.1926	17.4 n
0.022	B	200.2	0.1892	21.3 n
0.027	B	156.7	0.2227	29.2 n
0.033	B	273.4	0.1597	38.4 n
0.039	B	197.6	0.2976	34.0 n
0.047	B	212.7	0.2630	44.2 n
0.056	B	277.6	0.3289	48.1 n
0.068	B	314.1	0.2958	61.8 n
0.082	B	325.6	0.2483	84.9 n
0.100	B	412.8	0.3469	84.9 n
0.10	A	11.46	0.5351	0.0935 μ
0.12	A	13.69	0.4697	0.1177 μ
0.15	A	13.69	0.4757	0.1424 μ
0.18	A	18.45	0.5231	0.1623 μ
0.22	A	28.14	0.4544	0.2012 μ
0.27	A	45.62	0.4926	0.2408 μ



Engineering Note ILB, ILBB, IMC, ISC, IFC

Circuit Simulation of Surface Mount Inductors
and Impedance Beads

Vishay Dale

IMC-1812				
NOMINAL INDUCTANCE (μH)	EQUIVALENT CIRCUIT DATA			
	CIRCUIT	RESISTANCE (kΩ)	CAPACITANCE (pF)	INDUCTANCE (μH)
0.33	A	28.00	0.5365	0.2957
0.39	A	29.24	0.5127	0.3429
0.47	A	29.47	0.5427	0.4508
0.56	A	41.36	0.4498	0.5104
0.68	A	32.51	0.4792	0.6067
0.82	A	32.76	0.4674	0.7412
1.00	A	12.40	1.6920	0.9513
1.20	A	12.33	1.6740	1.1640
1.50	A	14.92	1.6930	1.4020
1.80	A	18.89	1.4410	1.7370
2.20	A	23.51	1.6220	2.1300

ILBB-0603				
NOMINAL IMPEDANCE	EQUIVALENT CIRCUIT DATA			
	CIRCUIT	RESISTANCE (Ω)	CAPACITANCE (pF)	INDUCTANCE (μH)
40	A	65	0.900	0.0952
60	A	80	0.900	0.1533
68	A	100	0.900	0.1779
80	A	118	1.000	0.1993
120	A	157	1.200	0.3356
220	A	315	0.900	0.6037
300	A	420	0.800	0.7954
450	A	545	0.800	1.1186
600	A	690	0.800	1.4531
750	A	810	0.900	2.0182
1000	A	1.1k	0.658	2.4001

ILBB-0805				
NOMINAL IMPEDANCE	EQUIVALENT CIRCUIT DATA			
	CIRCUIT	RESISTANCE (Ω)	CAPACITANCE (pF)	INDUCTANCE (μH)
11	A	18	0.90	0.0273
32	A	50	0.85	0.1053
60	A	82	0.70	0.2114
90	A	125	1.00	0.2836
120	A	165	1.00	0.2969
150	A	208	1.00	0.4437
300	A	350	1.00	0.8621
400	A	510	0.90	1.3274
600	A	636	1.20	1.3454
1000	A	975	1.00	2.7573
1500	A	1600	1.00	4.7412
2000	A	2500	0.90	7.4365

Engineering Note ILB, ILBB, IMC, ISC, IFC



Vishay Dale

Circuit Simulation of Surface Mount Inductors
and Impedance Beads

ILB-1206				
NOMINAL IMPEDANCE	EQUIVALENT CIRCUIT DATA			
	CIRCUIT	RESISTANCE (Ω)	CAPACITANCE (pF)	INDUCTANCE (H)
19	A	27	0.9	63.51 n
26	A	37	0.8	75.00 n
50	A	75	0.4	109.60 n
31	A	37	1.0	73.34 n
70	A	95	0.2	174.12 n
120	A	150	1.5	352.33 n
150	A	180	0.9	492.76 n
300	A	330	1.8	1.05 μ
500	A	485	2.1	1.69 μ
600	A	610	2.0	2.49 μ

ISC-1210 0.10 μH TO 1 μH				
NOMINAL INDUCTANCE	EQUIVALENT CIRCUIT DATA			
	CIRCUIT	RESISTANCE (Ω)	CAPACITANCE (pF)	INDUCTANCE (H)
0.010	A	1.04	0.1003	0.00741
0.012	A	1.21	0.1051	0.00782
0.015	A	1.80	0.2178	0.01284
0.018	A	2.50	0.2487	0.01564
0.022	A	2.35	0.2434	0.01889
0.027	A	3.00	0.2279	0.02466
0.033	A	3.07	0.1983	0.03188
0.039	A	3.63	0.4437	0.03427
0.047	A	4.39	0.2873	0.03947
0.056	A	5.47	0.4233	0.04478
0.068	A	4.74	0.3259	0.06028
0.082	A	10.12	0.3506	0.07696
0.100	A	7.50	0.4130	0.08288
0.120	A	2.39	0.5536	0.12007
0.150	A	3.37	0.5382	0.14700
0.180	A	3.20	0.6848	0.16420
0.220	A	3.99	0.6573	0.22131
0.270	A	4.27	0.6229	0.25678
0.330	A	4.75	0.6377	0.31673
0.390	A	3.00	0.9118	0.39058
0.470	A	7.49	1.1016	0.44061
0.560	A	6.19	0.9598	0.50199
0.680	A	7.79	0.7370	0.62592
0.820	A	6.85	1.0187	0.80402
1.000	A	10.40	1.3400	0.98740

IFC-0805/0603
Contact factory for current data



FREQUENTLY ASKED QUESTIONS

Why is the equivalent circuit inductance less than the nominal value of the inductor? For instance, the equivalent circuit inductance listed for an IMC-1210 0.82 μ H inductor is only 0.74 μ H.

The effective inductance of a component can be adversely affected by the parasitic elements. Capacitance cancels out some of the inductive reactance and reduces the effective inductance of the device. Throughout a family of inductors, wire size, core size, core material and number of turns will be varied to achieve the proper inductance. The most efficient inductors (with smallest parasitic element) have the lowest number of turns, the largest wire and the optimum core dimensions.

Since it is not economically feasible to have ideal core and wire sizes for each inductance value in a series, some values will have more significant parasitic elements that affect the performance of the inductor. For example, one core and wire size may be used for as many as 5 adjacent values in an inductor series. The number of turns is varied to achieve the higher inductance values. An inductor with more turns will have more inter-winding capacitance so the highest inductor with the same core and wire size will typically be more affected by the winding capacitance than the lower values.

I would like to perform a Monte Carlo analysis that will examine my circuit over the tolerance range of all my components. How much can I expect the parasitic elements to change due to manufacturing tolerances?

This is a tough question to answer.

Vishay Dale and other inductor manufacturers sell inductors based on four major specifications:

Inductance \pm a percentage tolerance

Minimum Q at a specified frequency

Maximum DCR of the winding or conductor

Minimum SRF

In order to achieve these specifications, core size and material, wire size, and number of turns can be varied. Due to manufacturing tolerances on all of the inductor components, wire size and/or number of turns may vary on the same value across production lots. Varying the wire size and/or turns will affect the values of the parasitic components, however, the specified L, Q, DCR, and SRF will always be in tolerance. Vishay Dale designs and manufactures inductors with respect for the behavior of parasitic elements. Typically, the basic tolerance of the purchased inductor (i.e., 10 μ H \pm 10 %) can be applied to all the equivalent circuit elements in the inductor model with good success.

I use "S" parameters in my circuit simulator. Are they available for Vishay Dale inductors?

Because of the complexity of distributing "S" parameters for all the inductor series, we have opted not to provide "S" parameters for these products. As an alternative, most circuit simulation programs will generate "S" parameters for a simulated circuit. The equivalent circuit elements for the Vishay Dale inductors can be entered as a separate circuit into the simulator which can in turn generate a table or file of "S" parameters for the inductor model.

I am interested in simulating the performance of a Vishay Dale inductor that is not on the charts contained within this application note. How can I get equivalent circuit information for this inductor?

Vishay Dale will be adding equivalent circuit information for other products as demand requires. If there is a specific inductor you would like information on that has not been published, we can normally supply this information within one week of the request.

My circuit simulator already contains a library of inductive components models from Vishay Dale and other vendor products. How do I know if these are accurate models?

Some component libraries contain models that have been empirically generated from catalog specifications, and so these models may not accurately depict product performance. To have full confidence in your library of inductive component models, we strongly suggest that you contact the vendor of your circuit simulator to determine the source of the supplied inductor model data. All data included here in our Application Note has been generated by testing normally processed product and represents the typical performance you can expect from the Vishay Dale product.

Vishay Dale

Electro-Magnetic Interference and Electro-Magnetic Compatibility (EMI/EMC)

INTRODUCTION

Manufacturers of electrical and electronic equipment regularly submit their products for EMI/EMC testing to ensure regulations on electromagnetic compatibility are met. Inevitably, some equipment will fail, as the interference transmitted on cables connected to the equipment exceeds regulated limits, resulting in radiated emissions failure.

Additional problems can occur when connected equipment causes interference problems with the equipment under test resulting in component malfunction.

There are many ways to reduce the level of conducted and radiated interference, especially during the initial design of the circuit board.

These techniques include proper routing of tracks, proper use of ground planes, power supply impedance matching, and reducing logic frequency to a minimum.

Even with the most diligent employment of good EMI/EMC circuit design practices, not all interference or compatibility issues can be eliminated. At this point, additional components can be added, allowing the circuit to comply with design and regulation limits for EMI/EMC.

This engineering note will review both initial circuit board design practices and identify some after design components that can be used to solve EMI/EMC problems.

CIRCUIT DESIGN TIPS TO REDUCE EMI/EMC PROBLEMS

There are several areas where good circuit design practices are critical to the reduction or elimination of EMI/EMC problems. How the PCB layout is approached - not simply in the design but also the choice of components - directly affects the degree of EMI/EMC interference. Another area of concern is the circuit design of the power supply.

PCB Design Tips

- Avoid slit apertures in PCB layout, particularly in ground planes or near current paths
- Areas of high impedance give rise to high EMI, so use wide tracks for power lines on the trace sides
- Make signal tracks stripline and include ground plane and power plane whenever possible
- Keep HF and RF tracks as short as possible, and lay out the HF tracks first (Fig. 1)

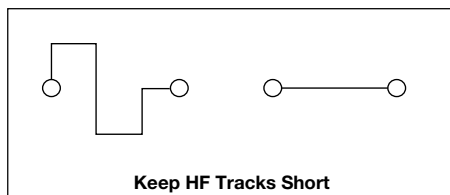

Fig. 1

- Avoid track stubs, as they cause reflections and harmonics (Fig. 2)

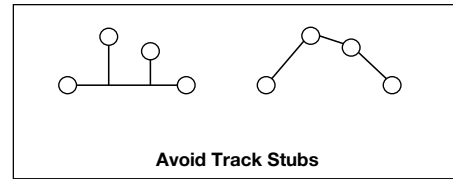

Fig. 2

- On sensitive components and terminations, use surrounding guard ring and ground fill where possible
- A guard ring around trace layers reduces emission out of the board; also, connect to ground only at a single point and make no other use of the guard ring (Fig. 3)

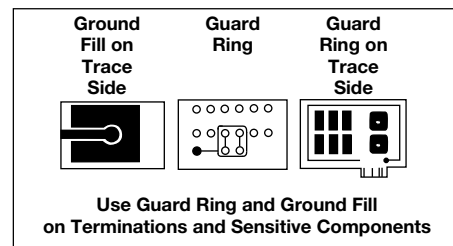

Fig. 3

- When you have separate power planes, keep them over a common ground to reduce system noise and power coupling (Fig. 4)

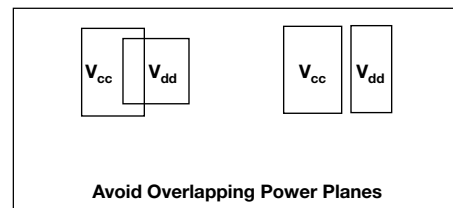

Fig. 4

- The power plane conductivity should be high, so avoid localized concentrations of via and through hole pads (surface mount is preferred mounting method)
- Track mitering (beveling of edges and corners) reduces field concentration
- If possible, make tracks run orthogonally between adjacent layers (Fig. 5)

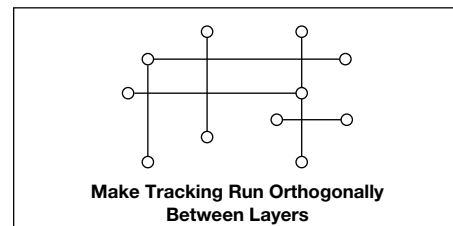

Fig. 5

- Do not loop tracks, even between layers, as this forms a receiving or radiating antenna.

- Do not leave floating conductor areas, as they act as EMI radiators; if possible connect to ground plane (often, these sections are placed for thermal dissipation, so polarity should not be a consideration, but verify with component data sheet). (Fig. 6)

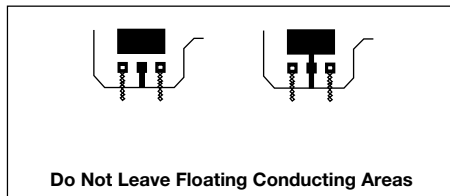

Fig. 6

Power Supply Considerations

- Eliminate loops in the supply lines. (Fig. 7)

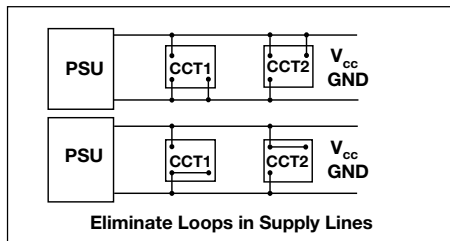

Fig. 7

- Decouple supply lines at local boundaries. (Fig. 8)

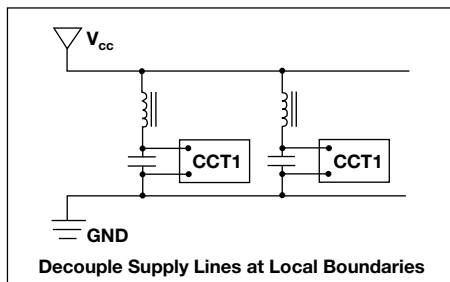

Fig. 8

- Place high speed circuits close to Power Supply Unit (PSU) and slowest sections furthest away to reduce power plane transients. (Fig. 9)

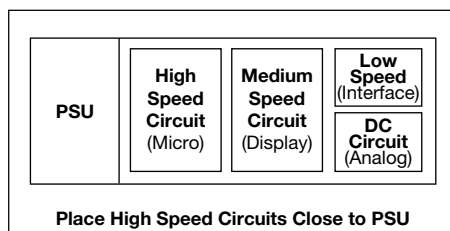

Fig. 9

- Isolate individual systems where possible (especially analog and digital systems) on both power supply and signal lines. (Fig. 10)

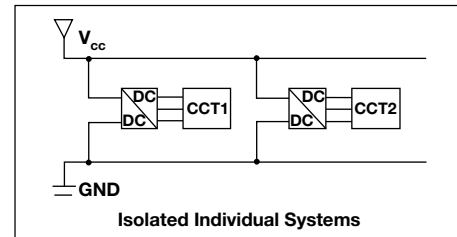

Fig. 10

Component Considerations

- Locate biasing and pull up/down components close to driver/bias points.
- Minimize output drive from clock circuits.
- Use common mode chokes (Vishay Dale series LPT4545 or LPT3535 or the LPE series of surface mount transformers) between current carrying and signal lines to increase coupling and cancel stray fields. (Fig. 11)

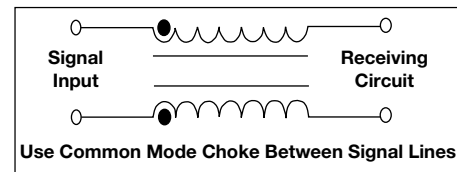

Fig. 11

- Decouple close to chip supply lines, to reduce component noise and power line transients. (Fig. 12)

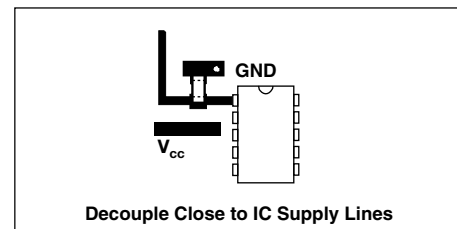

Fig. 12

- Use low impedance capacitors for decoupling and bypassing (ceramic multilayer capacitors, like those offered by Vishay Vitramon are preferred, offering high resonant frequencies and stability).
- Use discrete components for filters where possible (surface mount is preferable due to lower parasitic and aerial effects of termination's compared to through hole components).
- Ensure filtering of cables and overvoltage protection at the terminations (this is especially true of cabling that is external to the system, if possible all external cabling should be isolated at the equipment boundary).
- Minimize capacitive loading on digital output by minimizing fanout, especially on CMOS ICs (this reduces current loading and surge per IC).

If available, use shielding on fast switching circuits, main power supply components and low power circuitry (shielding is expensive and should be considered a "last resort" option).

MAGNETIC COMPONENTS FOR ELECTRO MAGNETIC INTERFERENCE REDUCTION AND ELECTRO MAGNETIC COMPATIBILITY

Products that use magnetics to reduce electro-magnetic interference and improve electro-magnetic compatibility within the circuit can be classified into several categories: inductors, chokes, transformers, ferrite beads, capacitors, and integrated passive devices that can incorporate any or all of the above devices. When considering any of these EMI/EMC components, it is necessary to identify circuit paths or areas likely to conduct or radiate noise.

Inductors

The most common magnetic EMI filter is the inductor or choke. Inductors are used for both line filtering and energy storage. If a circuit is suspected of being a source for EMI, often, selection of the right inductor can help eliminate the problem. For radiated interference, the choice of a shielded or toroidal inductor can often eliminate (or at least greatly reduce) the offending frequency. In fact, toroidal inductors like Vishay Dale's LPT-4545 and LPT-3535 surface mount, or Vishay Dale's TE, TD, or TJ series of leaded toroids virtually eliminate radiated fields because of the toroid's unique ability to contain the magnetic flux within its core.

LPT 4545
Toroidal
Inductor



The toroid is also less susceptible to induced noise from other components as the applied magnetic field would induce equal and opposite currents inside the toroid, thus canceling the induced interference.

Chokes

Common mode and differential mode chokes are used to eliminate noise on a pair of conductors. Common mode noise is defined as noise that is present or "common" to both conductors, and can be the result of induced noise caused by the "antenna" effect of a conductor or PC trace. Common mode noise is typically "in phase" within the conductors, while differential noise is present on only one conductor or present in opposite phase in both conductors. Common mode chokes use the properties of two closely coupled magnetic fields to eliminate the interference problem by canceling the noise within the magnetic fields. They are best employed to eliminate noise or EMI on cables or signal tracks. The choke should be located as close to the driver or receiver circuit as possible, or at the signal entry point of the circuit board. The proper selection of inductive component can also help in matching line impedance and can act as a bandwidth filter for the circuit. Vishay Dale's LPT and LPE series products can be configured in the common or differential mode depending on your application.

Transformers

The main benefit of using a transformer for EMI/EMC is that it can provide an isolation barrier between a signal line and the signal processing circuit (particularly where the signal line exits the board or system). This is true of signals being driven or received, since isolating the line reduces common

mode noise and eliminates ground (or signal return) potential differences between systems.

One particular area where high noise immunity is essential is in thyristor/triac driving circuits. Here the transformer provides an isolation between the driven load and a logic based controller. The isolating pulse transistor provides much better noise immunity than an insulated gate bi-polar transistor (IGBT) due to inherently lower coupling capacitance (typically 10's of pF for a pulse transformer compared to nF for a power IGBT device). The lower coupling capacitance improves the circuit's immunity from noise from the main power supply or from power switching devices. Vishay Dale's LPE and PT transformers can be used to meet your transformer needs. Many more EMI/EMC configurations can be provided through our custom magnetic design department.

LPE Series
Transformer

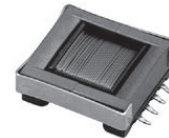

Surface Mount Ferrite Beads

Chip impeders, also called ferrite chip beads, perform the function of removing RF energy that exists within a transmission line structure (printed circuit board trace). To remove unwanted RF energy, chip beads are used as high frequency resistors (attenuators) that allow DC to pass while absorbing the RF energy and dissipating that energy in the form of heat.

ILBB/ILB
Ferrite
Beads

ILBB-0603



ILBB-0805

ILB-1206



Surface mount ferrite beads have many advantages:

- Small and light weight
- Inexpensive
- High impedance values removes broad range of RF energy
- Closed magnetic circuit eliminates cross talk
- Beads are inherently shielded
- Low DCR ratings minimizes desired signal degradation
- Excellent current carrying capacity compared to alternatives
- Outstanding performance at removing RF energy
- Spurious circuit oscillations or resonances are reduced because of the bead's resistive characteristics at RF frequencies
- Broad impedance ranges (several Ω to 2000 Ω)
- Operates effectively from several MHz to 1 GHz



Engineering Note ILB, ILBB Ferrite Beads

Electro-Magnetic Interference and
Electro-Magnetic Compatibility (EMI/EMC)

Vishay Dale

To choose the proper bead, you should consider the following:

1. What is the range of unwanted frequencies?
2. What is the source of the EMI?
3. How much attenuation is required?
4. What are the environmental and electrical conditions for the circuit (temperature DC voltage, DC bias currents, maximum operating currents, field strengths, etc...)?
5. What is the maximum allowable profile and board real estate for using this component?

Selection of the right bead for your particular frequencies is not a simple process. In most cases, since beads are only rated for impedance at 100 MHz, you will need to look at several graphs to determine the best bead for your frequency if it is different than 100 MHz.

This is a time consuming but necessary process to select the correct bead value since the highest impedance bead at 100 MHz is not necessarily the highest impedance bead at higher or lower frequencies. DC bias will also lower the effective impedance of the device.

EMI/EMC Component Selection

Before incorporating EMI/EMC components, it is necessary to identify the circuit paths and circuit areas most likely to conduct noise, and to identify circuit areas likely to act as antennas and radiate noise. At this point the most appropriate location for the chosen components can be determined.

The actual components chosen are determined by the frequency and signal level of the noise to be eliminated. Consideration should also be given for the frequencies that are to remain intact.

For attenuation less than 5dB inductive, EMI components are generally the best choice. For attenuation less than 5 dB, circuit type must first be considered.

Working with a high speed signal circuit, your best choice is a complex filter consisting of inductive and capacitive components (such as an LCR Filter). If your circuit is a general signal type (i.e., not a high speed circuit) grounding stability must first be determined. For stable grounds, capacitive EMI components are an excellent choice.

However, if the circuit has an unstable ground, high impedance inductive components should be considered for EMI suppression needs.

Designing equipment and choosing components is not an easy process. Often, the only measure of design success is the overall radiation level from your equipment. Trial and error is a long tedious process that can take several months to complete, and choosing the wrong component can waste time.

Here are three suggestions for more effective design:

- Always place EMI/EMC components as close as possible to the noise source.
- Select EMI/EMC components that match the impedance of the noise conduction path, not necessarily that of the circuit path. Remember that common mode noise often travels a different path than the circuit current.
- Start with EMI/EMC components that offer sufficient performance to meet your design standards. Component costs can be reduced once you have a working design.

VISHAY COMPONENTS FOR EMI/EMC COMPLIANCE

Surface Mount Ferrite Beads

ILB-1206, ILBB-0402 to ILBB-1812

Surface Mount, High Current Ferrite Beads

ILHB-0603 to IHLB-1812

Surface Mount Bead Arrays

ILAS-1206

Surface Mount Ferrite Inductors and Chokes

LPT-4545, LPT-3535

Surface Mount Transformers

LPE Series

Surface Mount Ceramic and Tantalum Capacitors

Ferrite Beads for EMI/EMC Compliance

One of the simplest and most effective ways to reduce EMI is through the use of ferrite beads. Initially, EMI suppression consisted of a small bead-shaped ferrite (hence the name bead) with a hole through the middle. The ferrite bead was slipped over the suspected "noisy" wire or component lead and EMI was reduced.

Today, beads are available in a variety of styles including the original through-hole model, multiple apertures and surface mount configurations.

How Ferrite Beads Work

The best way to conceptualize a bead is as a frequency dependent resistor. An equivalent circuit for a bead consists of a resistor and inductor in series. The resulting change (of impedance over frequency) is directly associated with the frequency dependent complex impedance of the ferrite material.

At low frequencies (below 10 MHz) the inductive impedance is 10 Ω or less, as shown below. At higher frequencies, the impedance of the bead increases to over 100 Ω , and becomes mostly resistive above 100 MHz.

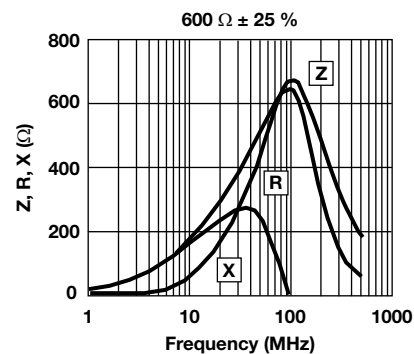

Since the bead's impedance is essentially resistive to high frequency circuits, the problem of resonance experienced by other EMI filtering choices like capacitors and inductors is eliminated. Often the bead is the only practical solution to an EMI problem.

When used as a high frequency filter, ferrite beads provide a resistive loss that attenuates the unwanted frequencies through minute heating of the bead's ferrite material due to eddy currents. At the same time, the bead presents minimal series impedance to the lower frequency or direct currents of the circuit.

USEFUL TABLES FOR EMI/EMC DESIGNS

DECIBELS						
DB ⁽¹⁾	POWER RATIO	VOLTAGE CURRENT RATIO		DB ⁽²⁾	POWER RATIO	VOLTAGE CURRENT RATIO
0	1.0	1.0		0	1.0	1.0
3	2.0	1.4		- 3	0.50	0.71
6	4.0	2.0		- 6	0.25	0.50
10	10.0	3.2		- 10	0.10	0.32
12	16.0	4.0		- 12	0.05	0.25
14	25.0	5.0		- 14	0.04	0.20
20	10 ²	10		- 20	10 ⁻²	0.10
30	10 ³	32		- 30	10 ⁻³	0.03
40	10 ⁴	10 ²		- 40	10 ⁻⁴	10 ⁻²
60	10 ⁶	10 ³		- 60	10 ⁻⁶	10 ⁻³
80	10 ⁸	10 ⁴		- 80	10 ⁻⁸	10 ⁻⁴
100	10 ¹⁰	10 ⁵		- 100	10 ⁻¹⁰	10 ⁻⁵
120	10 ¹²	10 ⁶		- 120	10 ⁻¹²	10 ⁻⁶
140	10 ¹⁴	10 ⁷		- 140	10 ⁻¹⁴	10 ⁻⁷

Notes

(1) $dB = 10 \log_{10} \frac{P_1}{P_2}$

(2) $dB = 20 \log_{10} \frac{V_1}{V_2} = 20 \log_{10} \frac{I_1}{I_2}$

ELECTRIC FIELD LEVELS						
W	1 m	10 m	100 m	1 km	10 km	
1	5.5 V/m	0.55 V/m	0.05 V/m	5.5 V/m	0.55 mV/m	
10	17.4 V/m	1.7 V/m	0.17 V/m	17 V/m	1.7 mV/m	
100	55 V/m	5.5 V/m	0.55 V/m	55 V/m	5.5 mV/m	
1K	174 V/m	17.4 V/m	1.74 V/m	170 V/m	17 mV/m	
10K	550 V/m	55 V/m	5.5 V/m	550 V/m	55 mV/m	
100K	1740 V/m	174 V/m	17.4 V/m	1.74 V/m	174 mV/m	

Notes

- Table assumes an antenna gain of one
- $E = \frac{5.5 \sqrt{PA}}{d}$
- P = Power at antenna in W
d = Distance from antenna in m (valid when $d > \lambda/2\pi$)
E = Electric field in V/m
A = Antenna gain (1 for table)

CISPR 22 LIMITS		
FREQUENCY (MHz)	CLASS A	CLASS B
RADIATED		
30 to 230	40 dB π V/m	30 dB V/m
230 to 1000	47 dB π V/m	37 dB V/m
Quasi-peak, antenna at 10 m		
CONDUCTED		
0.15 to 0.50	66 dB π V/m	56 dB π V/m to 46 dB π V/m
0.50 to 5	60 dB π V/m	46 dB π V/m
5 to 30	60 dB π V/m	50 dB π V/m
Average		



Engineering Note ILB, ILBB Ferrite Beads

Electro-Magnetic Interference and
Electro-Magnetic Compatibility (EMI/EMC)

Vishay Dale

FREQUENCY VS. WAVELENGTH			
f	λ	$\lambda/2$	$\lambda/20$
10 Hz	30 000 km	4800 km	1500 km
60 Hz	5000 km	800 km	250 km
100 Hz	3000 km	480 km	150 km
400 Hz	750 km	120 km	37 km
1 kHz	300 km	48 km	15 km
10 kHz	30 km	4.8 km	1.5 km
100 kHz	3 km	480 m	150 m
1 MHz	300 m	48 m	15 m
10 MHz	30 m	4.8 m	1.5 m
100 MHz	3 m	0.48 m	15 cm
1 GHz	30 cm	4.8 cm	1.5 cm
10 GHz	3 cm	4.8 mm	1.5 mm

Note

- f = Frequency
- λ = Wavelength
- $\lambda/2\pi$ = Near field to far field distance
- $\lambda/20$ = Antenna effects of wires and slots

CAPACITOR SELF RESONANCE			
FARADS	TOTAL LEAD LENGTH		
	1/4"	1/2"	1"
500 pF	100 MHz	72 MHz	50 MHz
1000 pF	72	51	36
0.01 F	23	16	11
0.1 F	7.2	5.1	3.6
0.3 F	4.2	2.9	2.1
0.5 F	3.2	2.3	1.6

Note

- $f = \frac{1}{2\pi\sqrt{LC}}$; L = 20 nH/inch

RISE TIMES - FREQUENCY - LENGTH				
t_r	f_{eq}	L_{cross}	$L_{cross/2}$	L_{term}
1 ns	318 MHz	1.0 ft.	6"	3"
3 ns	95 MHz	3.0 ft.	1.5 ft.	9"
10 ns	32 MHz	10 ft.	5 ft.	2.5 ft.
30 ns	9.5 MHz	30 ft.	15 ft.	7.5 ft.
100 ns	3.2 MHz	100 ft.	50 ft.	25 ft.
300 ns	950 MHz	300 ft.	150 ft.	75 ft.
1 μ s	320 MHz	1000 ft.	500 ft.	250 ft.

Note

- t_r = Rise time
- f_{eq} = Equivalent frequency $1/\pi t_r$
- L_{cross} = Length of one rise time in free space
- $L_{cross/2}$ = Typical length of rise time on cable or printed circuit board (crosstalk)
- L_{term} = Length of terminate on cable or printed circuit board

Frequency Dependence of Inductor Testing and Correlation of Results Between Q Meters and Impedance Meters

This engineering note is in response to questions raised regarding differences of inductance testing results between Vishay Dale products tested using a “Q” meter as the standard and similar inductor products produced by other manufacturers that use an impedance meter as the standard. It will also discuss the frequency dependence of inductance and Q (Quality Factor) when testing.

The primary values used to specify an inductor or coil are inductance, Q, Self-Resonant Frequency (SRF), and Direct Current Resistance (DCR). The first two parameters, inductance and Q, are very dependant on the testing frequency and the instrument used for testing. Inductance is specified in Henries, usually with a tolerance. Q, being an indication of relative losses within an inductor, is unitless, and is based on the ratio of inductive reactance (X_L) and effective resistance (R_e) at frequency (X_L/R_e). As can be seen from this formula, Q is very dependent on frequency. At lower frequencies, the inductive reactance (X_L) changes faster than effective resistance (R_e); at higher frequencies, the reverse is true. SRF is specified in Hertz and DCR in Ohms.

Many Vishay Dale leaded and surface mount inductors are referenced from what has been the industry standard test instrument: the HP4342A Q meter (it is important to note that using the Q meter as the standard does not mean that the product is necessarily tested on that meter, but only that values are referenced back to what a Q meter would read if it was testing the part). This common industry test method/instrument has historical ties back to military specifications and standards and is still in wide use throughout the industry as the standard by which values are determined. Recently, the impedance analyzer has been gaining preference as the new standard for inductance measurements of radio frequency coils (especially commercial surface mount products). The following is a brief description of the reasons for this trend.

The Q meter is made up of a variable frequency signal generator, a calibrated variable capacitor, and a high impedance RF Voltmeter. There are several sources of error when testing with a Q meter. The first is Residual Inductance which is defined as the sum of the internal inductance of the Q meter as well as the inductance of any test leads or fixtures. It is determined by using a shorting bar with a known inductance value. This value is then subtracted from any Measured Inductance to give the Effective Inductance. The next error is called Distributed Capacitance which is defined as the total distributed capacitance of the inductor under test. Distributed Capacitance is only a concern with inductors with large inductance values (typically above 1 mH).

The fundamental difficulty with measuring inductance and Q is that coil inductance, parasitics⁽¹⁾ of the coil and test fixture, and Q are highly dependant on the test frequency and the configuration of the test instrument and fixture. Q meters require the use of a test fixture that has parasitics that can vary from one test fixture to another. This variance requires compensation before testing to get accurate and repeatable results. It is also important to understand that the Q meter operates by resonating the coil under test with a variable capacitor. At resonance, the meter indicates the capacitance value on a dial that the test operator must judge by reading the dial. The resolution of the analog dial often introduces parallax errors that add to the inaccuracy in the measurement.

Note

⁽¹⁾ Unwanted stray inductance and capacitance inherent in the product's construction



Frequency Dependence of Inductor Testing and Correlation of Results Between Q Meters and Impedance Meters

Vishay Dale

Commercially available Q meters have inductance measurement accuracies of no better than 3 %. The accuracy can be improved by the use of setup standards called correlation pieces or samples. The correlation samples are used as the standard for a specific component value and are then used to “calibrate” the meter every time testing of components is performed. The use of correlation samples has been the traditional industry test method used to improve accuracy of Q meters, and results in little error and provides consistent readings. However, this correlation process has significant disadvantages. For the best accuracy, correlation sample standards must be established and shared between the manufacturer and the customer. Also, each Q meter must be “calibrated” with the correlation standard before each test.

Because of the inherent difficulties in using a Q meter accurately, the use of impedance analyzers as the standard has become much more common. Impedance analyzers (i.e., HP4191, HP4194) have accuracies that can be better than ± 1 % for impedances near 50 Ω and a machine to machine repeatability of approximately 1 %. Overall session-to-session test repeatability on the same instrument is also 1 %. The use of impedance analyzers also eliminates the need for correlation samples. In addition, the analyzers have digital readouts which remove the potential for problems associated with dial reading/parallax errors.

Selection of a test instrument will influence test results. Different instruments have different capabilities and accuracies. As stated, the frequency used during testing will also cause a variation in test results. Even the tolerance of a coil will change with frequency because of the variances in parasitics within the coil (i.e., a 5 % tolerance coil tested at one frequency may only be a 10 % tolerance coil at another frequency). Below is a table that shows the typical variations that can be expected for the same coil tested on different instruments and at different frequencies.

TYPICAL VARIATIONS		
INSTRUMENT	FREQUENCY	INDUCTANCE
HP4342A Q meter	25 MHz	682.3 nH
HP4192A	0.130 MHz	607.0 nH
HP4192A	10 MHz	592.7 nH
Boonton 62AD	1 MHz	594.0 nH
Tektronix LC130	0.130 MHz	1300.0 nH
HP4191A	100 MHz	1065.0 nH

As can be seen in the table above, it is difficult to get similar results between two different meters or by testing at two different frequencies. This difference is more pronounced when using meters with different test methods (Q meter versus impedance analyzer). If the testing instrument and or method is different between the manufacturer and the customer, it is possible to establish a correlation between the two readings by testing a controlled set of parts on both machines and averaging the difference to establish a correlation factor. This is only recommended when the test instruments are different and should not be used when different testing frequencies are involved.

Following the trend toward the use of impedance analyzers as the standardized industry test method, and to eliminate correlation issues, Vishay Dale offers testing (at customer request) using the impedance analyzer as the standard in lieu of the Q meter. However, because reliable Q measurements can be made on the Q meter, and because of the number of existing customer designs that are based on this standard, the HP4342A Q meter will remain the reference instrument for all Q measurements. If the alternate test method is desired, then we can accommodate customer needs by designating the product with a special part number or by linking the special testing requirements to the customer part number. The IMC-1812-91, IMC-1210-91, ISC-1812-91, and ISC-1210-91 are among several parts that reflect this test method and should be considered for future use if the customer requires value testing based on the impedance analyzer standard. It should be noted that changing from standard product to the special “-” series of products like the -91 will, in most cases, have little or no impact on price or delivery. Vishay Dale will continue to monitor testing trends and will make changes as required to meet overall customer needs. If you have further questions regarding this issue, please contact the factory at (605) 665-9301.

SMD Magnetics Packaging Methods

TAPE AND REEL in inches [millimeters]											
MODEL	PACKAGE CODE			REEL SIZE	CARRIER TAPE WIDTH (W)	COMPONENT PITCH (P)	UNITS/REEL	PACKAGE CODE			UNITS/BULK
	PREVIOUS CODE	GLOBAL CODE LEAD (Pb)-BEARING	GLOBAL CODE LEAD (Pb)-FREE					PREVIOUS CODE	GLOBAL CODE LEAD (Pb)-BEARING	GLOBAL CODE LEAD (Pb)-FREE	
IHLP-1212AB	-	-	ER	13	0.472 [12.0]	0.315 [8.0]	3000	-	-	-	-
IHLP-1212AE	-	-	ER	13	0.472 [12.0]	0.315 [8.0]	3000	-	-	-	-
IHLP-1212BZ	-	-	ER	13	0.472 [12.0]	0.315 [8.0]	3000	-	-	-	-
IHLP-1616AB	-	-	ER	13	0.630 [16.0]	0.315 [8.0]	4000	-	-	EB	100
IHLP-1616BZ	-	-	ER	13	0.630 [16.0]	0.315 [8.0]	4000	-	-	EB	100
IHLP-2020AB	-	-	ER	13	0.630 [16.0]	0.315 [8.0]	4000	-	-	EB	100
IHLP-2020BZ	-	-	ER	13	0.630 [16.0]	0.315 [8.0]	2000	-	-	EB	100
IHLP-2020CZ	-	-	ER	13	0.630 [16.0]	0.315 [8.0]	2000	-	-	EB	100
IHLP-2525AH	-	-	ER	13	0.630 [16.0]	0.315 [8.0]	2000	-	-	EB	100
IHLP-2525BD	-	-	ER	13	0.630 [16.0]	0.315 [8.0]	2000	-	-	EB	100
IHLP-2525CZ	-	-	ER	13	0.630 [16.0]	0.315 [8.0]	2000	-	-	EB	100
IHLP-2525EZ	-	-	ER	13	0.630 [16.0]	0.472 [12.0]	500	-	-	EB	100
IHLP-3232CZ	-	-	ER	13	0.630 [16.0]	0.472 [12.0]	1000	-	-	EB	100
IHLP-3232DZ	-	-	ER	13	0.630 [16.0]	0.472 [12.0]	500	-	-	EB	100
IHLP-4040DZ	-	-	ER	13	0.945 [24.0]	0.630 [16.0]	500	-	-	EB	100
IHLP-5050CE	-	-	ER	13	0.945 [24.0]	0.630 [16.0]	500	-	-	EB	100
IHLP-5050EZ	-	-	ER	13	0.945 [24.0]	0.630 [16.0]	250	-	-	EB	100
IHLP-5050FD	-	-	ER	13	0.945 [24.0]	0.630 [16.0]	250	-	-	EB	100
IHLP-6767DZ	-	-	ER	13	0.945 [24.0]	0.945 [24.0]	250	-	-	EB	100
IHLP-6767GZ	-	-	ER	13	0.945 [24.0]	0.945 [24.0]	200	-	-	EB	100
IHLM-2525CZ	-	-	ER	13	0.630 [16.0]	0.315 [8.0]	2000	-	-	EB	100
IHLW-4040CF	-	-	ER	13	0.945 [24.0]	0.630 [16.0]	500	-	-	EB	100
IHLW-5050CE	-	-	ER	13	0.945 [24.0]	0.630 [16.0]	500	-	-	EB	100
IFSC-0806AZ	-	-	ER	7	0.315 [8.0]	0.157 [4.0]	2000	-	-	-	-
IFSC-1008AB	-	-	ER	7	0.315 [8.0]	0.157 [4.0]	2000	-	-	-	-
IFSC-1111AZ	-	-	ER	7	0.315 [8.0]	0.157 [4.0]	2000	-	-	-	-
IFSC-1111AB	-	-	ER	7	0.315 [8.0]	0.157 [4.0]	2000	-	-	-	-
IFSC-1515AH	-	-	ER	13	0.472 [12.0]	0.315 [8.0]	2000	-	-	-	-
IHSM-3825	RC2	RE	ER	13	0.945 [24.0]	0.472 [12.0]	750	P09	PJ	EB	100
IHSM-4825	RC2	RE	ER	13	0.945 [24.0]	0.472 [12.0]	750	P09	PJ	EB	100
IHSM-5832	RC3	RF	ER	13	1.26 [32.0]	0.472 [12.0]	500	P09	PJ	EB	100
IHSM-7832	RC4	RG	ER	13	1.73 [44.0]	0.472 [12.0]	500	P09	PJ	EB	100
IDC-2512	-	-	ER	13	0.630 [16.0]	0.315 [8.0]	2000	-	-	-	-
IDC-5020	-	-	ER	13	0.630 [16.0]	0.472 [12.0]	500	-	-	-	-
IDC-7328	-	-	ER	13	0.945 [24.0]	0.945 [24.0]	250	-	-	-	-
IDCS-2512	-	-	ER	13	0.630 [16.0]	0.315 [8.0]	2000	-	-	-	-
IDCS-5020	-	-	ER	13	0.630 [16.0]	0.472 [12.0]	500	-	-	-	-
IDCS-7328	-	-	ER	13	0.945 [24.0]	0.945 [24.0]	250	-	-	-	-
IDCP-1813	-	-	ER	13	0.472 [12.0]	0.315 [8.0]	2000	-	-	-	-
IDCP-2218	-	-	ER	13	0.472 [12.0]	0.315 [8.0]	1500	-	-	-	-
IDCP-3114	-	-	ER	13	0.630 [16.0]	0.472 [12.0]	1000	-	-	-	-
IDCP-3020	-	-	ER	13	0.630 [16.0]	0.472 [12.0]	1000	-	-	-	-
IDCP-3722	-	-	ER	13	0.945 [24.0]	0.472 [12.0]	800	-	-	-	-
IDCP-3916	-	-	ER	13	0.945 [24.0]	0.472 [12.0]	800	-	-	-	-
IFCB-0402	-	-	ER	7	0.315 [8.0]	0.079 [2.0]	10 000	-	-	-	-
IFCB-0603	-	-	ER	7	0.315 [8.0]	0.157 [4.0]	5000	-	-	-	-



TAPE AND REEL in inches [millimeters]											
MODEL	PACKAGE CODE			REEL SIZE	CARRIER TAPE WIDTH (W)	COMPONENT PITCH (P)	UNITS/ REEL	PACKAGE CODE			UNITS/ BULK
	PREVIOUS CODE	GLOBAL CODE LEAD (Pb)- BEARING	GLOBAL CODE LEAD (Pb)-FREE					PREVIOUS CODE	GLOBAL CODE LEAD (Pb)- BEARING	GLOBAL CODE LEAD (Pb)-FREE	
ILC-0402	-	-	ER	7	0.315 [8.0]	0.079 [2.0]	10 000	-	-	-	-
ILC-0603	-	-	ER	7	0.315 [8.0]	0.157 [4.0]	4000	-	-	-	-
ILC-0805	-	-	ER	7	0.315 [8.0]	0.157 [4.0]	4000	-	-	-	-
IMC-0402	-	-	ER	7	0.315 [8.0]	0.079 [2.0]	10 000	-	-	-	-
IMC-0402-01	-	-	ER	7	0.315 [8.0]	0.079 [2.0]	10 000	-	-	-	-
IMC-0603	-	-	ER	7	0.315 [8.0]	0.157 [4.0]	4000	-	-	-	-
IMC-0603-01	-	-	ER	7	0.315 [8.0]	0.079 [2.0]	3000	-	-	-	-
IMC-0805	-	-	ER	7	0.315 [8.0]	0.157 [4.0]	3000	-	-	-	-
IMC-0805-01	-	-	ER	7	0.315 [8.0]	0.157 [4.0]	2000	-	-	-	-
IMC-1008	-	-	ER	7	0.315 [8.0]	0.157 [4.0]	2000	-	-	-	-
IMC-1210	R98/RB3 R99/RB4	SY/AN SZ/R9	ER/ET ES/EU	7 13	0.315 [8.0] 0.315 [8.0]	0.157 [4.0] 0.157 [4.0]	2000 7500	B13	BN	EB	500
IMC-1210-100	R98/RB3 R99/RB4	SY/AN SZ/R9	ER/ET ES/EU	7 13	0.315 [8.0] 0.315 [8.0]	0.157 [4.0] 0.157 [4.0]	2000 7500	B13	BN	EB	500
IMC-1812	R73/R92 R13/R91	RV/RX RQ/RW	ER/ET ES/EU	7 13	0.472 [12.0] 0.472 [12.0]	0.315 [8.0] 0.315 [8.0]	500 2000	B13	BN	EB	500
IMCH-1812	-	-	ER	7	0.472 [12.0]	0.315 [8.0]	500	-	-	-	-
IMC-2220	-	-	ER	13	0.630 [16.0]	0.472 [12.0]	1000	-	-	-	-
ISC-1008	-	-	ER	13	0.472 [12.0]	0.157 [4.0]	750	-	-	-	-
ISC-1210	R98/RB3 R99/RB4	SY/AN SZ/R9	ER/ET ES/EU	7 13	0.315 [8.0] 0.315 [8.0]	0.157 [4.0] 0.157 [4.0]	2000 7500	B13	BN	EB	500
ISC-1812	R73/R92 R13/R91	RV/RX RQ/RW	ER/ET ES/EU	7 13	0.472 [12.0] 0.472 [12.0]	0.315 [8.0] 0.315 [8.0]	500 2000	B13	BN	EB	500
ICM-0805	-	-	ER	7	0.315 [8.0]	0.157 [4.0]	2000	-	-	-	-
ICM-1206	-	-	ER	7	0.315 [8.0]	0.157 [4.0]	2000	-	-	-	-
ICM-2824	-	-	ER	13	0.630 [16.0]	0.472 [12.0]	2000	-	-	-	-
ICM-3528	-	-	ER	13	0.945 [24.0]	0.472 [12.0]	900	-	-	-	-
ICM-4743	-	-	ER	13	0.945 [24.0]	0.630 [16.0]	500	-	-	-	-
ILSB-0603	-	-	ER	7	0.315 [8.0]	0.157 [4.0]	4000	-	-	-	-
ILSB-0805 (0.047 µH to 2.2 µH)	-	-	ER	7	0.315 [8.0]	0.157 [4.0]	4000	-	-	-	-
ILSB-0805 (2.7 µH to 33 µH)	-	-	ER	7	0.315 [8.0]	0.157 [4.0]	3000	-	-	-	-
ILSB-1206	-	-	ER	7	0.315 [8.0]	0.157 [4.0]	3000	-	-	-	-
ILBB-0402	-	-	ER	7	0.315 [8.0]	0.157 [4.0]	10 000	-	-	-	-
ILBB-0603	-	-	ER	7	0.315 [8.0]	0.157 [4.0]	4000	-	-	-	-
ILBB-0805	-	-	ER	7	0.315 [8.0]	0.157 [4.0]	4000	-	-	-	-
ILB-1206	-	-	ER ES	7 13	0.315 [8.0] 0.315 [8.0]	0.157 [4.0] 0.157 [4.0]	3000 10 000	-	-	-	-
ILBB-1210	-	-	ER	7	0.315 [8.0]	0.157 [4.0]	2000	-	-	-	-
ILBB-1806	-	-	ER	7	0.472 [12.0]	0.157 [4.0]	2000	-	-	-	-
ILBB-1812	-	-	ER	7	0.472 [12.0]	0.157 [4.0]	1000	-	-	-	-
ILHB-0603	-	-	ER	7	0.315 [8.0]	0.157 [4.0]	4000	-	-	-	-
ILHB-0805	-	-	ER	7	0.315 [8.0]	0.157 [4.0]	4000	-	-	-	-
ILHB-1206	-	-	ER	7	0.315 [8.0]	0.157 [4.0]	3000	-	-	-	-
ILHB-1806	-	-	ER	7	0.315 [8.0]	0.157 [4.0]	2000	-	-	-	-
ILHB-1812	-	-	ER	7	0.315 [8.0]	0.157 [4.0]	1000	-	-	-	-
ILAS-1206	-	-	ER	7	0.315 [8.0]	0.157 [4.0]	3000	-	-	-	-
LPE-3325	R94	RY	ER	13	0.945 [24.0]	0.472 [12.0]	1000	S51	SM	EB	10
LPE-4841	R94	RY	ER	13	0.945 [24.0]	0.630 [16.0]	600	S51	SM	EB	10
LPE-5047	R94	RY	ER	13	0.945 [24.0]	0.630 [16.0]	600	S51	SM	EB	10
LPE-6562	R94	RY	ER	13	1.26 [32.0]	0.787 [20.0]	300	S51	SM	EB	10
LPE-6855	R94	RY	ER	13	1.26 [32.0]	0.787 [20.0]	450	S51	SM	EB	10
LPE-3325-CST	-	-	ER	13	0.945 [24.0]	0.472 [12.0]	1000	-	-	EB	10
LPT-3535	RC5	RH	ER	13	0.945 [24.0]	0.630 [16.0]	600	S51	SM	EB	10
LPT-4545	RC5	RH	ER	13	0.945 [24.0]	0.630 [16.0]	600	S51	SM	EB	10

Inductance and Tolerance Conversion Tables for Global Part Numbers

INDUCTANCE CODES

nH	H	SAP
1		1N0
1.2		1N2
1.5		1N5
1.8		1N8
2.2		2N2
2.7		2N7
3.3		3N3
3.9		3N9
4.7		4N7
5.6		5N6
6.8		6N8
8.2		8N2
10	0.01	10N
12	0.012	12N
15	0.015	15N
18	0.018	18N
22	0.022	22N
27	0.027	27N
33	0.033	33N
39	0.039	39N
47	0.047	47N
56	0.056	56N
68	0.068	68N
82	0.082	82N
100	0.1	R10
120	0.12	R12
150	0.15	R15
180	0.18	R18
220	0.22	R22
270	0.27	R27
330	0.33	R33
390	0.39	R39
470	0.47	R47
560	0.56	R56
680	0.68	R68

nH	H	SAP
820	0.82	R82
	1	1R0
	1.2	1R2
	1.5	1R5
	1.8	1R8
	2.2	2R2
	2.7	2R7
	3.3	3R3
	3.9	3R9
	4.7	4R7
	5.6	5R6
	6.8	6R8
	8.2	8R2
	10	100
	12	120
	15	150
	18	180
	22	220
	27	270
	33	330
	39	390
	47	470
	56	560
	68	680
	82	820
	100	101
	120	121
	150	151
	180	181
	220	221
	270	271
	330	331
	390	391
	470	471
	560	561

nH	H	SAP
	680	681
	820	821
	1000	102
	1200	122
	1500	152
	1800	182
	2200	222
	2700	272
	3300	332
	3900	392
	4700	472
	5600	562
	6800	682
	8200	822
	10 000	103
	12 000	123
	15 000	153
	18 000	183
	22 000	223
	27 000	273
	33 000	333
	39 000	393
	47 000	473
	56 000	563
	68 000	683
	82 000	823
	100 000	104
	120 000	124
	150 000	154
	180 000	184
	220 000	224
	270 000	274
	330 000	334

TOLERANCE CODES

B = ± 0.15 nH	J = ± 5 %
C = ± 0.2 nH	K = ± 10 %
S = ± 0.3 nH	L = ± 15 %
D = ± 0.5 nH	M = ± 20 %
F = ± 1 %	V = ± 25 %
G = ± 2 %	N = ± 30 %
H = ± 3 %	

PACKAGE CODES

See packaging methods for conversion.



Models Listed in Linear Tech Publication

MAGNETICS PRODUCTS	DESCRIPTION	IC TYPE	CIRCUIT DESCRIPTION
IHSM-4825	High Current, Molded, Inductor	LT1507	Representative Surface Mount Units
IHSM-4825 10 μ H	High Current, Molded, Inductor	LT1375/LT1376	1.5 A, 500 kHz Step-Down Switching Regulator
IHSM-4825 10 μ H	High Current, Molded, Inductor	LT1507	500 kHz Monolithic Buck Mode Switching Regulator
IHSM-4825 2.7 μ H	High Current, Molded, Inductor	LT1374	4.5 A, 500 kHz Step-Down Switching Regulator
IHSM-4825 2.7 μ H	High Current, Molded, Inductor	LT1506	4.5 A, 500 kHz Step-Down Switching Regulator
IHSM-4825 22 μ H	High Current, Molded, Inductor	LT1375/LT1376	1.5 A, 500 kHz Step-Down Switching Regulator
IHSM-4825 4.7 μ H	High Current, Molded, Inductor	LT1374	4.5 A, 500 kHz Step-Down Switching Regulator
IHSM-4825 4.7 μ H	High Current, Molded, Inductor	LT1506	4.5 A, 500 kHz Step-Down Switching Regulator
IHSM-5832	High Current, Molded, Inductor	LT1507	Auxiliary 5 V/3 A, 3.3 V/3.5 A, 12 V/0.2 A Regulator
IHSM-5832 10 μ H	High Current, Molded, Inductor	LT1374	4.5 A, 500 kHz Step-Down Switching Regulator
IHSM-5832 10 μ H	High Current, Molded, Inductor	LT1375/LT1376	1.5 A, 500 kHz Step-Down Switching Regulator
IHSM-5832 10 μ H	High Current, Molded, Inductor	LT1506	4.5 A, 500 kHz Step-Down Switching Regulator
IHSM-5832 10 μ H	High Current, Molded, Inductor	LT1507	500 kHz Monolithic Buck Mode Switching Regulator
IHSM-5832 15 μ H	High Current, Molded, Inductor	LT1374	4.5 A, 500 kHz Step-Down Switching Regulator
IHSM-5832 15 μ H	High Current, Molded, Inductor	LT1506	4.5 A, 500 kHz Step-Down Switching Regulator
IHSM-5832 22 μ H	High Current, Molded, Inductor	LT1375/LT1376	1.5 A, 500 kHz Step-Down Switching Regulator
IHSM-7832 22 μ H	High Current, Molded, Inductor	LT1374	4.5 A, 500 kHz Step-Down Switching Regulator
IHSM-7832 22 μ H	High Current, Molded, Inductor	LT1375/LT1376	1.5 A, 500 kHz Step-Down Switching Regulator
IHSM-7832 22 μ H	High Current, Molded, Inductor	LT1506	4.5 A, 500 kHz Step-Down Switching Regulator
ILB-1206 19 Ω 25 %	Chip Bead	LTC1550-4.1	Low Noise, Regulated, Switched-Capacitor Voltage Inverter
ILB-1206 31 Ω 25 %	Chip Bead	LTC1174CS8	Low Noise, High Efficiency Step-Down Regulator for Personal Communications Devices
ILS-3825-01	Multilayer Power Inductor	LT1106	Micropower Step-Up DC/DC Converter of PCMCIA Card Flash Memory, 12 V, 60 mA Flash Memory Programming Supply
ILS-3825-01	Multilayer Power Inductor	LT1106	Flash Memory VPP Generator
LPE-3325-A142	SMD Current Sense Transformer	LT1431CS8	35 W Isolated DC/DC Converter
LPE-3325-A190	SMD Transformer	LT1307	High Voltage Flyback Converter
LPE-3325-A205	SMD Transformer	LTC1304 LTC-1304-3.3 LT1304-5	Electroluminescent Panel Driver with 200 Hz Oscillator
LPE-4841-100MB	SMD Inductor/Transformer	LT1372/LT1377	Dual Output Flyback Converter with Overvoltage Protection
LPE-4841-100MB	SMD Inductor/Transformer	LT1373	Dual Output Flyback Converter with Overvoltage Protection
LPE-4841-330MB	SMD Inductor/Transformer	LT1425	Isolated Flyback Switching Regulator 5 V to Isolated - 9 V _{out}
LPE-4841-A307	SMD Transformer	LT1424-5	Isolated Flyback Switching Regulator with 5 V Output
LPE-4841-A307	SMD Transformer	LT1425	- 9 V Isolate LAN Supply
LPE-4841-A307	SMD Transformer	LT1425	1.5 V to - 9 V/250 mA Isolated LAN Supply
LPE-4841-A307	SMD Transformer	LTC1435	Dual Output 5 V and Synchronous 12 V Application
LPE-4841-A313	SMD Transformer	LT1316	Nonisolated - 48 V to 5 V Flyback Converter
LPE-4841-A313	SMD Transformer	LT1316	50 V to 6 V Isolated Flyback Converter

Linear Tech Cross Reference



Vishay Dale

Models Listed in Linear Tech Publication

MAGNETICS PRODUCTS	DESCRIPTION	IC TYPE	CIRCUIT DESCRIPTION
LPE-4841-A313	SMD Transformer	LT1316	- 48 V to 5 V Flyback Converter
LPE-5047-100MB	SMD Inductor/Transformer	LT1370	Dual Output Flyback Converter with Overvoltage Protection
LPE-5047-100MB	SMD Inductor/Transformer	LT1371	Dual Output Flyback Converter with Overvoltage Protection
LPE-5047-100MB	SMD Inductor/Transformer	LT1371	Compact Dual Output, 500 kHz 5 V to \pm 15 V Flyback Converter
LPE-5047-A045 same as: LPE-5047-100MB	SMD Transformer	LT1300	LCD Contrast Supply
LPE-5047-A045 same as: LPE-5047-100MB	SMD Transformer	LT1301	LCD Contrast Supply
LPE-5047-A045 same as: LPE-5047-100MB	SMD Transformer	LT1301	Micropower LCD Contrast Supply Use only 10 μ A in a Shutdown
LPE-5047-A132	SMD Transformer	LT1303	EL Panel Driver
LPE-5047-A132	SMD Transformer	LT1303	High-Efficiency EL Driver Circuit
LPE-5047-A132	SMD Transformer	LT1305	EL Panel Driver
LPE-5047-A132	SMD Transformer	LT1305	EL Panel Driver for Large Display Area
LPE-5047-A132	SMD Transformer	LT1305	Circuit for Driving Electroluminescent Panels in Portable Devices
LPE-5047-A132	SMD Transformer	LT1303	EL Panel Driver
LPE-6562-220MB	SMD Inductor/Transformer	LTC1149-5	Ultra Wide Input Range (5.5 V to 25 V) High Efficiency 5 V Regulator
LPE-6562-220MB	SMD Inductor/Transformer	LTC1149-5	Ultra Wide Input Range (5.5 V to 25 V) High Efficiency 5 V Regulator
LPE-6562-A026	SMD Transformer	1/2LTC1142HV (5 V REG)	Deriving 14 V Power from an Auxiliary Winding on the LTC1142HV 5 V Regulator
LPE-6562-A026	SMD Transformer	LTC1142	Triple Output Regulator with Switched 12 V Output
LPE-6562-A026	SMD Transformer	LTC1142	Auxiliary Winding Power Supply Deriving 14 V Power from a 5 V Auxiliary Winding
LPE-6562-A026	SMD Transformer	LTC1142	Auxiliary Winding Power Supply Deriving 14 V Power from a 3.3 V Auxiliary Winding
LPE-6562-A026	SMD Transformer	LTC1142	Triple Output Buck Converter (6.5 V to 14 V to 3.3 V/2 A, 5 V/2 A, 12 V/0.15 A)
LPE-6562-A026	SMD Transformer	LTC1142	Triple Output High Efficiency Power Supply
LPE-6562-A026	SMD Transformer	LTC1142, LT1121	High-Efficiency Power Supply
LPE-6562-A026	SMD Transformer	LTC1142HV	Dual Slot PCMCIA Driver/Regulator Powered from Auxiliary Winding on the LTC1142HV 5 V Regulator
LPE-6562-A026	SMD Transformer	LTC1142HV	Deriving 14 V Power from an Auxiliary Winding on the LTC1142HV 5 V Regulator
LPE-6562-A026	SMD Transformer	LTC1142HV	Auxiliary Winding Power Supply
LPE-6562-A026	SMD Transformer	LTC1142HV	PCMCIA VPP Supply Generated from Switching Regulator Auxiliary Winding
LPE-6562-A026	SMD Transformer	LTC1142HV	High Voltage Triple Output Buck Converter (6.5 V to 18 V to 3.3 V/2 A, 5 V/2 A, 12 V/0.15 A)
LPE-6562-A026	SMD Transformer	LTC1148	Deriving Auxiliary 14 V Power from an LTC1148 5 V Regulator
LPE-6562-A026	SMD Transformer	LTC1148-3.3	Auxiliary Winding Power Supply Deriving 14 V Power from a 3.3 V Auxiliary Winding
LPE-6562-A026	SMD Transformer	LTC1148-5	Auxiliary Winding Power Supply Deriving 14 V Power from a 5 V Auxiliary Winding



Linear Tech Cross Reference

Models Listed in Linear Tech Publication

Vishay Dale

MAGNETICS PRODUCTS	DESCRIPTION	IC TYPE	CIRCUIT DESCRIPTION
LPE-6562-A026	SMD Transformer	LTC1471, LT1313	Dual Socket Design for Applications Requiring Two PC Card Sockets
LPE-6562-A069	SMD Inductor	LT1302	3 Cells to 3.3 V Buck-Boost Converter with Auxiliary 12 V Regulated Output
LPE-6562-A086	SMD Transformer	LTC1142HV	Deriving 14 V Auxiliary 14 V Power from an LTC1142HV 3.3 V Regulator
LPE-6562-A092	SMD Transformer	LTC1434	2.5 V/5 A Adjustable Output with 5 V Auxiliary Output
LPE-6562-A092	SMD Transformer	LTC1435	Dual Output 5 V and 12 V Application
LPE-6562-A092	SMD Transformer	LTC1435A	Dual Output 5 V and 12 V Application
LPE-6562-A092	SMD Transformer	LTC1436	2.9 V/5 A Adjustable with 5 V Auxiliary Output
LPE-6562-A092	SMD Transformer	LTC1436	3.3 V/4 A fixed Output with 5 V Auxiliary Output
LPE-6562-A092	SMD Transformer	LTC1436	5 V/3 A Fixed Output with 12 V Auxiliary Output
LPE-6562-A092	SMD Transformer	LTC1436A-PLL	5 V/3 A Fixed Output with 12 V Auxiliary Output an Uncommitted Comparator
LPE-6562-A092	SMD Transformer	LTC1436-PLL	2.5 V/5 A Adjustable Output with Foldback Current limiting and 5 V Auxiliary Output
LPE-6562-A092	SMD Transformer	LTC1436-PLL	Fixed Output with 12 V/200 mA Auxiliary Output and Uncommitted comparator
LPE-6562-A092	SMD Transformer	LTC1437A	5 V/3 A Fixed Output with 12 V Auxiliary Output
LPE-6562-A092	SMD Transformer	LTC1439	3.3 V and 5 V Dual Output Step-Down Switching Regulator with 12 V Regulated Auxiliary
LPE-6562-A214	SMD Transformer	LTC1439	4 Output High Efficiency Low Noise 5 V/3 A, 3.3 V/3 A, 2.9 V/2.6 A, 12 V/200 mA Notebook Computer Power Supply
LPE-6562-A214	SMD Transformer	LTC1538	High Efficiency 5 V/20 mA Standby, 3.3 V/2.5 V Regulator with Low Noise 12 V Linear Regulator
LPE-6562-A214	SMD Transformer	LTC1539	High Efficiency 5 V/20 mA Standby, 3.3 V/2.5 A Regulator with Low Noise 12 V Linear Regulator
LPE-6562-A236	SMD Transformer	LTC1435	Dual Output 5 V and Synchronous 12 V Application
LPE-6562-A236	SMD Transformer	LTC1435A	Dual Output 5 V and Synchronous 12 V Application
LPE-6562-A236	SMD Transformer	LTC1438	Representative Surface Mount Units
LPE-6562-A236	SMD Transformer	LTC1539	5 Output High Efficiency Low Noise 5 V/3 A, 3.3 V/3 A, 2.9 V/2.6 A, 12 V/200 mA, 5 V/20 mA Notebook Computer Power Supply
LPE-6562-A262	SMD Transformer	LT1539	High Efficiency Low Noise 5 V/20 mA Standby, 5 V/3 A, 3.3 V/3.5 A and 12 V/200 mA Regulator
LPE-6562-A262	SMD Transformer	LTC1438	High Efficiency Low Noise 5 V/3 A, 3.3 V/3.5 A and 12 V/200 mA Regulator
LPE-6562-A262	SMD Transformer	LTC1539	High Efficiency Low Noise 5 V/20 mA Standby, 5 V/3 A, 3.3 V/3.5 A and 12 V/200 mA Regulator
LPE-6562-A262	SMD Transformer	LT1538	High Efficiency Low Noise 5 V/20 mA Standby, 5 V/3 A, 3.3 V/3.5 A and 12 V/200 mA Regulator
LPE-6562-A262	SMD Transformer	LTC1538-AUX	5 V/3 A, 3.3 V/3.5 A, 12 V/0.2 A Regulator
LPT-4545-100LA	SMD Toroidal Inductor	LT1302	Micropower High Output Current Step-Up Adjustable and Fixed 5 V DC/DC Converters
LPT-4545-101LA	SMD Toroidal Inductor	LTC1433	9 V to 12 V, - 12 V Outputs
LPT-4545-101LA	SMD Toroidal Inductor	LTC1433 LTC1434	9 V to 12 V, - 12 V Outputs
LPT-4545-200LA	SMD Toroidal Inductor	LT1302	Micropower High Output Current Step-Up Adjustable and Fixed 5 V DC/DC Converters
LPT-4545-200LA	SMD Toroidal Inductor	LTC1433	5 V to \pm 5 V Outputs

Linear Tech Cross Reference



Vishay Dale

Models Listed in Linear Tech Publication

MAGNETICS PRODUCTS	DESCRIPTION	IC TYPE	CIRCUIT DESCRIPTION
LPT-4545-200LA	SMD Toroidal Inductor	LTC1433 LTC1434	5 V to \pm 5 V Outputs
LPT-4545-330LA	SMD Toroidal Inductor	LTC1265	5 V Buck-Boost Converter
LPT-4545-330LA	SMD Toroidal Inductor	LTC1265	Logic Selectable 0 V/3.3 V/5 V 700 mA Regulator
LPT-4545-330LA	SMD Toroidal Inductor	LTC1626	Single Li-Ion to 3.3 V Buck-Boost Converter
LPT-4545-330LA	SMD Toroidal Inductor	LTC1626	Single Li-Ion to 3.3 V Buck-Boost Converter
LPT-4545-500LA	SMD Toroidal Inductor	LTC1265	9 V to 12 V and - 12 V Outputs
LPT-4545-500LA	SMD Toroidal Inductor	LTC1265-5	Positive-to-Negative (- 5 V) Converter
LPT-4545-500LA	SMD Toroidal Inductor	LTC1265-5	Positive (+ 3.5 to 7.5 V) to Negative (- 5 V) Converter
LPT-4545-A001	SMD Toroidal Inductor	LTC1266-3.3	Low Dropout, 3.3 V/3 A High Efficiency Regulator
LPT-4545-A002	SMD Toroidal Inductor	LTC1266	5 V to 12 V/500 mA High Efficiency Boost Regulator
TC-10-04	Leaded Converter Transformer	LT1013	5 V Powered EEPROM Pulse Generator
TE-3Q3TA	Leaded Toroidal Inductor	LT1013	Low Power 9 V to 5 V Converter
TJ4-100-1 μ H	Leaded Toroidal Inductor	LTC1159	High Efficiency 12 V to -12 V 1 A Converter
TJ4-100-1 μ H	Leaded Toroidal Inductor	LTC1159	High Efficiency 12 V to - 12 V Converter



Build **Vishay**
into your **Design**

WORLDWIDE SALES CONTACTS

Visit www.vishay.com for product information or select below
for a current list of sales offices, representatives, and distributors.

THE AMERICAS

UNITED STATES

VISHAY AMERICAS
ONE GREENWICH PLACE
SHELTON, CT 06484
UNITED STATES
PH: +1-402-563-6866
FAX: +1-402-563-6296

ASIA

SINGAPORE

VISHAY INTERTECHNOLOGY
ASIA PTE LTD.
37A TAMPINES STREET 92 #07-00
SINGAPORE 528886
PH: +65-6788-6668
FAX: +65-6788-0988

P.R. CHINA

VISHAY CHINA CO., LTD.
15D, SUN TONG INFOPORT PLAZA
55 HUAI HAI WEST ROAD
SHANGHAI 200030
P.R. CHINA
PH: +86-21-5258 5000
FAX: +86-21-5258 7979

JAPAN

VISHAY JAPAN CO., LTD.
SHIBUYA PRESTIGE BLDG. 4F
3-12-22, SHIBUYA
SHIBUYA-KU
TOKYO 150-0002
JAPAN
PH: +81-3-5466-7150
FAX: +81-3-5466-7160

EUROPE

GERMANY

VISHAY ELECTRONIC GMBH
GEHEIMRAT-ROSENTHAL-STR. 100
95100 SELB
GERMANY
PH: +49-9287-71-0
FAX: +49-9287-70435

FRANCE

VISHAY S.A.
199, BLVD DE LA MADELEINE
06003 NICE, CEDEX 1
FRANCE
PH: +33-4-9337-2727
FAX: +33-4-9337-2726

UNITED KINGDOM

VISHAY LTD.
SUITE 6C, TOWER HOUSE
ST. CATHERINE'S COURT
SUNDERLAND ENTERPRISE PARK
SUNDERLAND SR5 3XJ
UNITED KINGDOM
PH: +44-191-516-8584
FAX: +44-191-549-9556



World Headquarters

Vishay Intertechnology, Inc.
63 Lancaster Avenue
Malvern, PA 19355-2143
United States

One of the World's Largest
Manufacturers
of Discrete Semiconductors and Passive Components



Copyright © 2012 by Vishay Intertechnology, Inc.
Registered Trademarks of Vishay Intertechnology, Inc.
All rights reserved. Printed in Germany.
Specifications subject to change without notice.

www.vishay.com