



HYT 939 (with sintered metal filter)

Digital Humidity and Temperature Module

Optimal for highly sophisticated, industrial applications

Benefits & Characteristics

- Calibrated and temperature compensated
- High chemical resistance
- Wide humidity and temperature range
- Very stable at high humidity
- Mechanically robust
- Excellent humidity/temperature accuracy and stability
- I²C protocol (address 0x28 or alternative address)
- Very low drift
- Interchangeable without adjustments

Illustration¹⁾

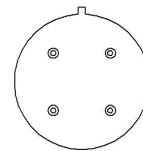
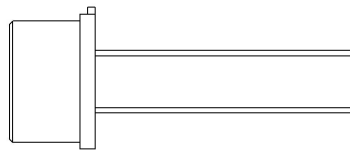
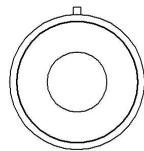

1) For actual size, see mechanical dimensions

Technical Data

Operating temperature range:	-40 °C to +125 °C
Operating humidity range:	0 % RH to 100 % RH
Hysteresis:	< ±1 % RH
Linearity error:	< ±1 % RH
Temperature error:	0.05 % RH/K (0 °C to +60 °C)
Operating voltage:	2.7 V to 5.5 V
Current consumption (nominal):	< 22 µA at 1 Hz measuring rate; 850 µA max.
Current consumption (sleep):	< 1 µA
Digital interface:	I ² C, address 0x28 or alternative address
Operating voltage (limits):	-0.3 V to 6 V
Storage conditions:	-20 °C to +50 °C

	Humidity	Temperature
Accuracy:	±1.8 % RH at +23 °C (0 % RH to 90 % RH)	±0.2 K (0 °C to +60 °C)
Reproducibility:	±0.2 % RH	±0.1 K
Resolution:	0.02 % RH	0.015 °C
Response time t_{63} :	< 10 s with metal mesh filter	< 10 s with metal mesh filter
Long-term drift:	< 0.5 % RH/a (at +23 °C and 30 % RH to 70 % RH - laboratory conditions)	< 0.05 K/a
Measuring principle:	Capacitive polymer humidity sensor	PTAT (integrated)



Product Photo

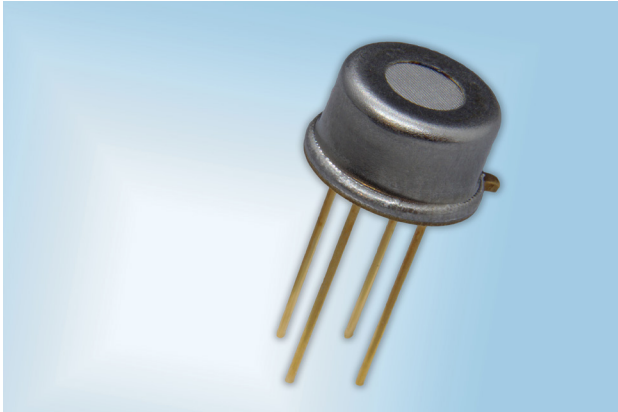

Mechanical Dimensions - HYT 939

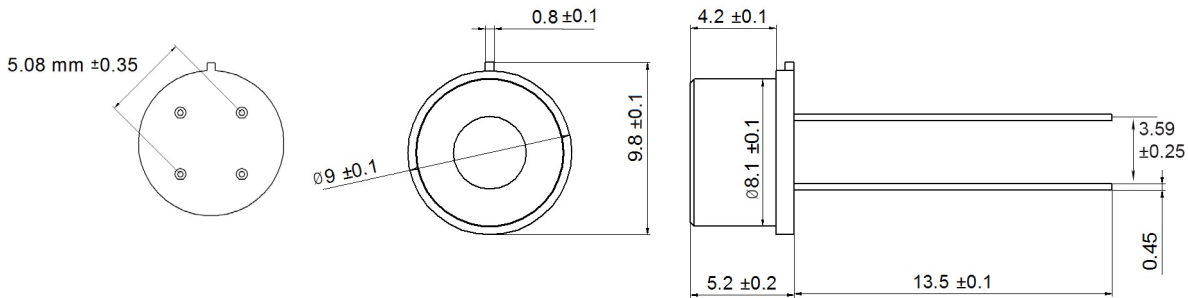

Pin Assignment

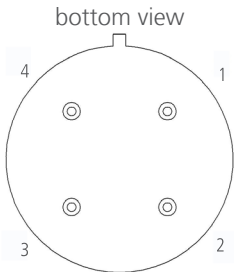

1	2	3	4
SCL	VCC	GND	SDA



Order Information

Description:	Item number:	Former main reference:
HYT 939 (with sintered metal filter)	103922	150.00067

Additional Electronics

Description:	Item number:	Former main reference:
HYT LabKit	103925	150.00073



Application Note

Humidity Modules

HYT

HYT271

Mechanically robust, chemical resistant and dew formation resistant, the digital humidity sensor with only 10.2 mm x 5.1 mm x 1.8 mm size offers the widest application window and an optimal price performance ratio. Precisely calibrated, the HYT271 delivers an accuracy of $\pm 1.8\%$ RH and $\pm 0.2\text{ }^\circ\text{C}$ - ideal for sophisticated mass applications, industrial handheld devices and precise humidity transmitters. Like all representatives of the HYT family, the sensor combines the advantages of a precise, capacitive polymer humidity sensor with the high integration density and functionality of an ASIC. The signal processing integrated in the sensor completely processes the measured data and directly delivers the physical parameters of relative humidity and temperature over the I²C compatible interface as digital values.

The module is precisely calibrated by the manufacturer and is therefore fully interchangeable without adjustment. Both the linearity error as well as temperature drift are corrected "on-chip" through computation resulting in an outstanding accuracy over a wide range of applications. The high chemical resistance, dew formation resistant design and an excellent long-term stability speaks for itself.

Typical Areas of Application:

- Handheld measurement instruments
- Humidity transmitters
- Industrial applications
- Measuring technology
- HVAC

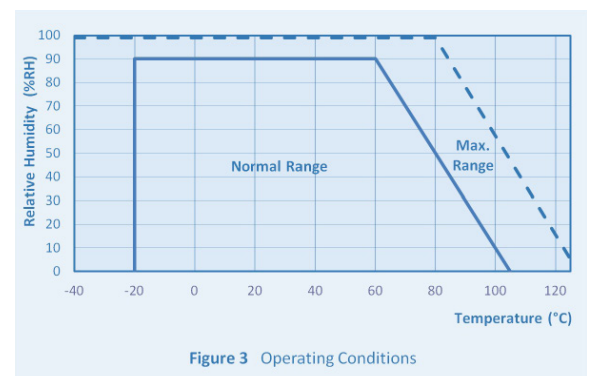
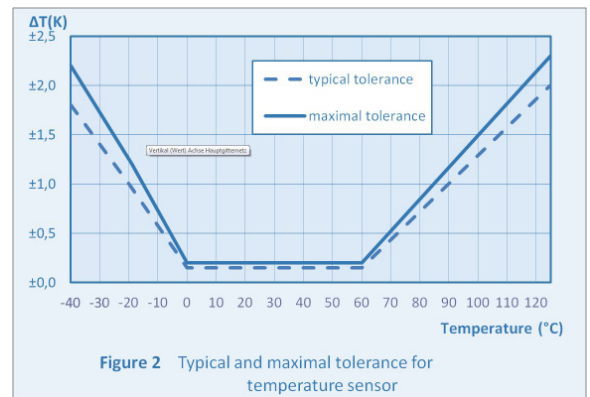
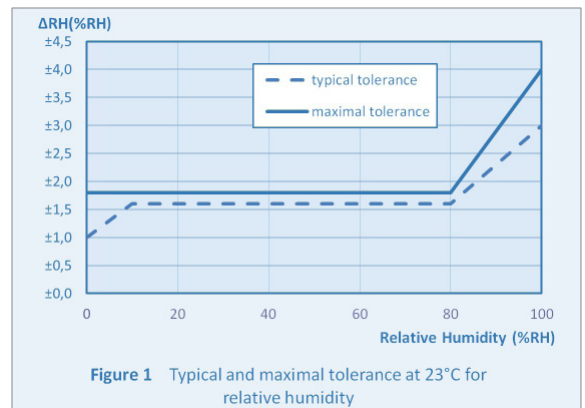



Mechanical Dimensions

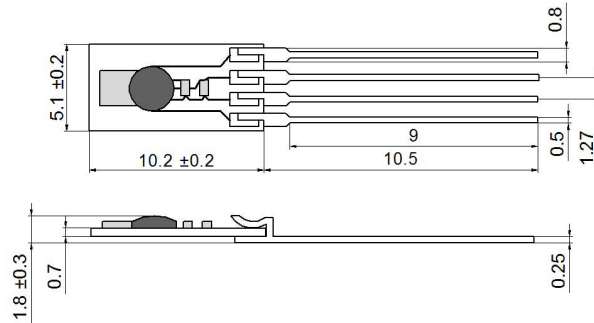

Pin Assignment

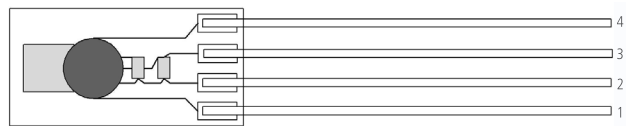

1	2	3	4
SDA	GND	VDD	SCL

1.1 Packaging

The digital humidity sensor HYT271 is packaged in a plastic blister. Be careful when opening the plastic blister to avoid damaging the sensor.

To avoid damages handle as follows:



1. Digital humidity sensors delivered in plastic blister



2. Open the plastic blister carefully

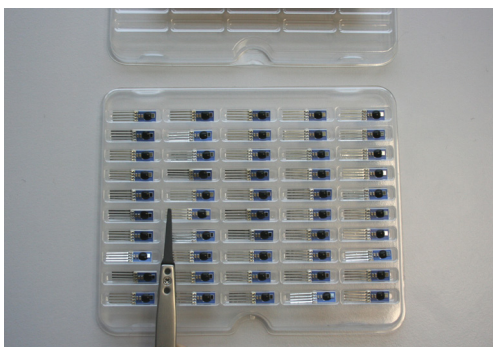

3. Take the sensors from the blister with plastic tweezers

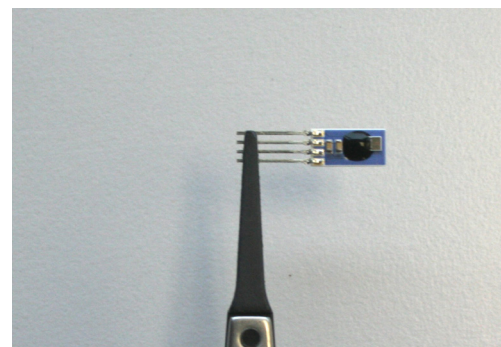

4. Use plastic tweezers only to handle the sensor



1.2 Storage Temperature

The digital humidity sensor HYT271 has to be stored in the original plastic blister only.
 Storage temperature (limited by the plastic tube): -20 °C to +50 °C



1.3 Active Sensor Area

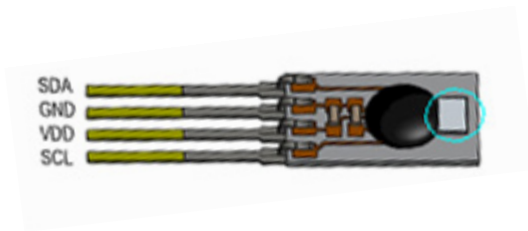

1.4 Sensor Handling

Hold the sensor with plastic tweezers or with gloves on the wires only



Sensor held with plastic tweezers on the wires only

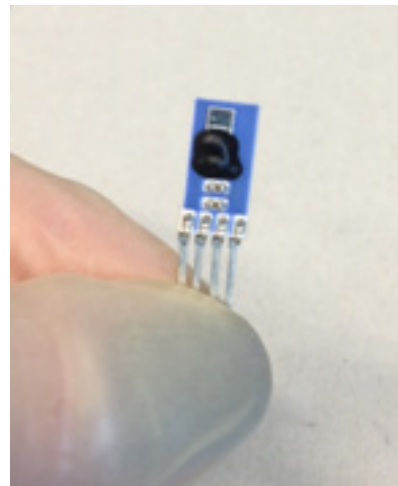

Sensor held with gloves on the wires only

Examples of prohibited handling:

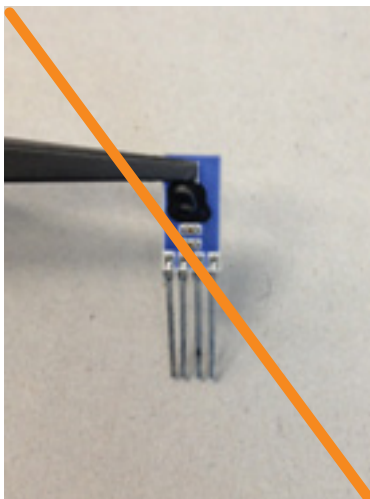

Sensor picked on the active area

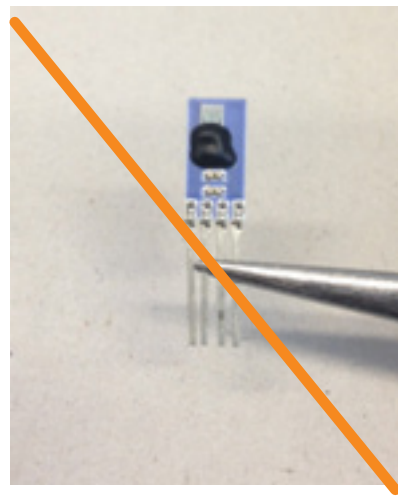

Sensor picked on the wires with metal tweezers

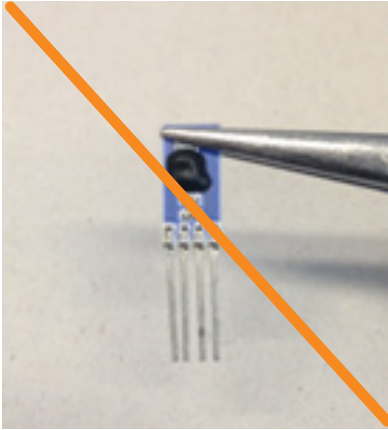

Sensor picked on the active area with metal tweezers

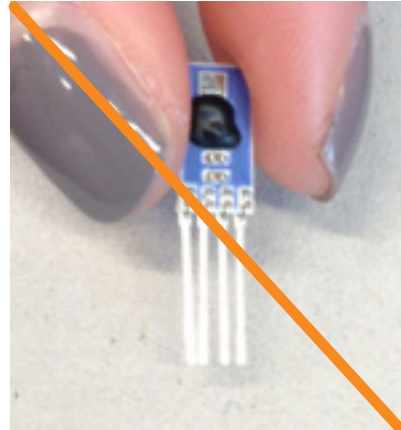

Sensor held with fingers without gloves

- Do not touch the active area of the sensor
- Do not use metal tweezers to handle the sensors
- Never handle the sensor by hand without gloves
- Avoid mechanical stress to the sensor, e.g. bending or touching the sensor with sharp objects
- Hold the sensor with plastic tweezers on the wires and side edges only
- Do not touch or scratch the active area of the sensors. Scratches and contaminations can degrade the sensor characteristic (see bad examples below)

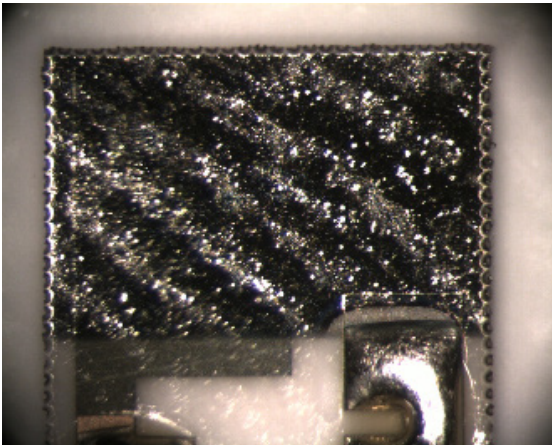

Sensor with contaminations



Sensor with a scratch

1.5 Soldering of the Sensor

It is recommended to solder the modules by hand or to insert the modules directly without soldering. It is not recommended to expose the HYT-modules to reflow soldering. The 320 °C maximum temperature of the soldering iron may not be exceeded. Maximum heat applied to the iron or solder wave cannot exceed 10 s and only at the very end of the connecting wires.

Avoid soldering flux residues caused by the soldering process or any other contaminations inside the active area of the sensor. Soldering flux residues on the outside of the active sensor area are not critical.

If the sensor is mounted with glue, baking the sensor at 60 °C for 1 h after the gluing process is recommended.

1.6 Cleaning of the Sensor

Residues can be removed with isopropanol at room temperature. Applying low ultrasonic energy could improve the cleaning process. The sensor must be dried after the cleaning process.

The sensor cannot be cleaned mechanically with cotton swabs.

It is possible to clean the sensor with oil free and filtered clean air, e.g. to remove dust particles.



HYT221

The round stainless steel casing can easily be fitted into housing openings and can be sealed against the wall with the use of an O-ring. Combined with the waterproof metal filter, it results into an assembly that is splash water proof and enables a sealed housing construction while providing a high dynamic responsiveness. Precisely calibrated, the HYT221 delivers an accuracy of ± 1.8 % RH and ± 0.2 °C. Like all representatives of the HYT family, the sensor combines the advantages of a precise, capacitive polymer humidity sensor with the high integration density and functionality of an ASIC. The signal processing integrated in the sensor completely processes the measured data and directly delivers the physical parameters of relative humidity and temperature over the I²C compatible interface as digital values. The module is precisely calibrated by the manufacturer and is therefore fully interchangeable without adjustment.

Both the linearity error as well as the temperature drift are corrected “on-chip” through computation resulting in an outstanding accuracy over a wide range of applications. Due to mechanical robustness, high chemical stability, dew formation resistance as well as excellent long term stability, the typical areas of application are humidity measurement in saunas, applications in outdoor areas or industrial applications in the field of drying systems.

Typical Areas of Application:

- Meteorology
- Industrial drying systems
- Medical devices
- Agriculture

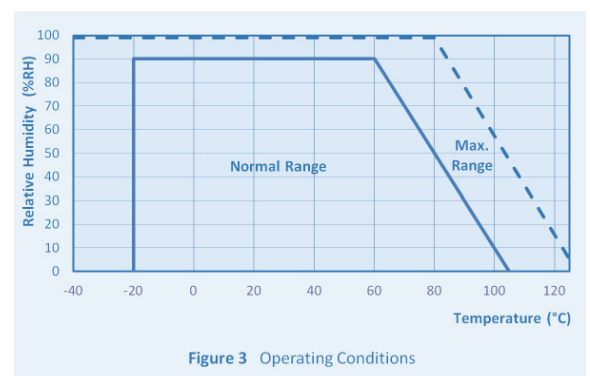
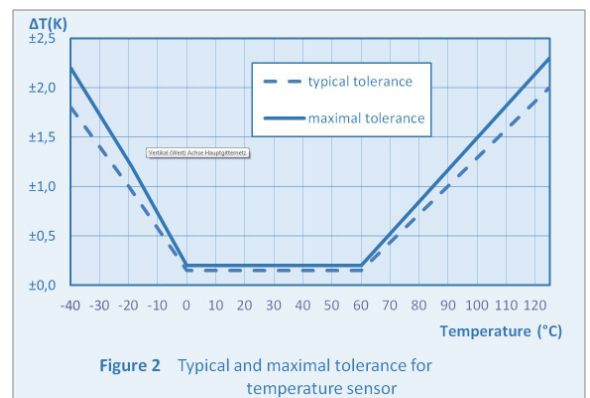
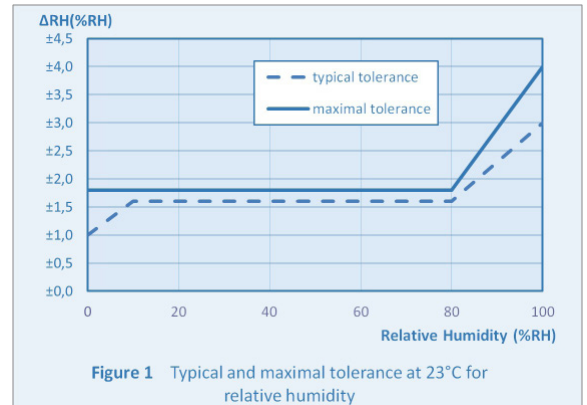



Mechanical Dimensions

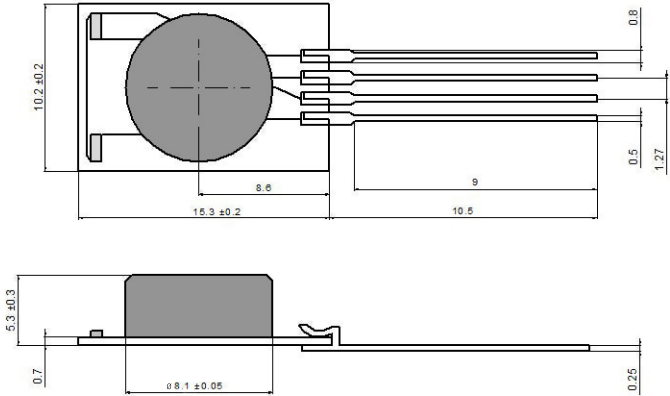

Pin Assignment

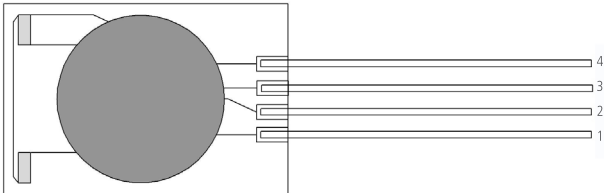

1	2	3	4
SDA	GND	VCC	SCL



HYT939

Precisely calibrated, the HYT939 delivers an accuracy of $\pm 1.8\%$ RH and $\pm 0.2\text{ }^\circ\text{C}$. Further features are the integrated signal processing for measuring the physical parameters of relative humidity and temperature, the I²C compatible interface, easy interchangeability without adjustment as well as mechanical robustness, chemical resistance, dew formation resistance and long-term stability.

Both the linearity error and temperature drift are corrected "on-chip" through computation. Because of the special robust construction, the sensor also withstands peak loading at high temperatures. Therefore, this special model is also ideal for extremely sophisticated industrial applications in drying systems and suitable for medical systems.

For a pressure tight sensor packaging consult IST AG.

Typical Areas of Application:

- Medical systems
- Autoclaves
- Pressure dew point measurement (pressure tight sensor packaging required)
- Drying systems
- Laboratories

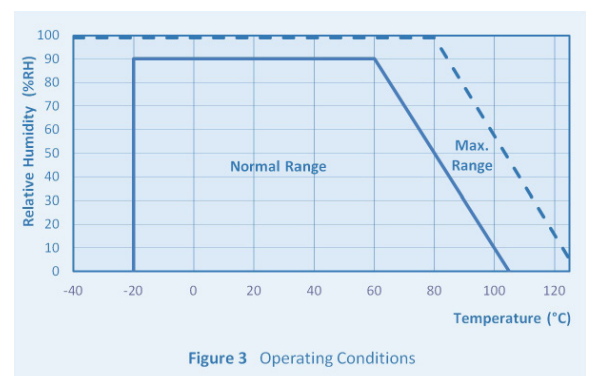
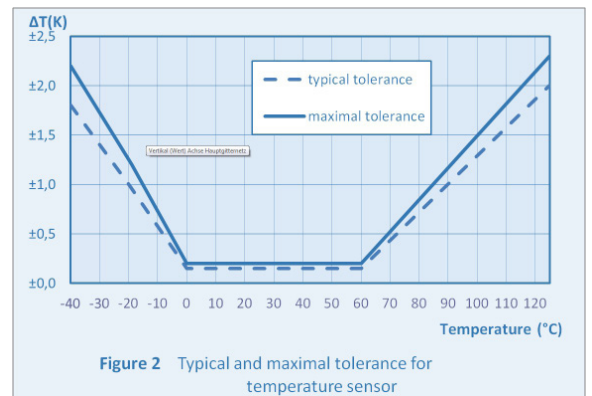
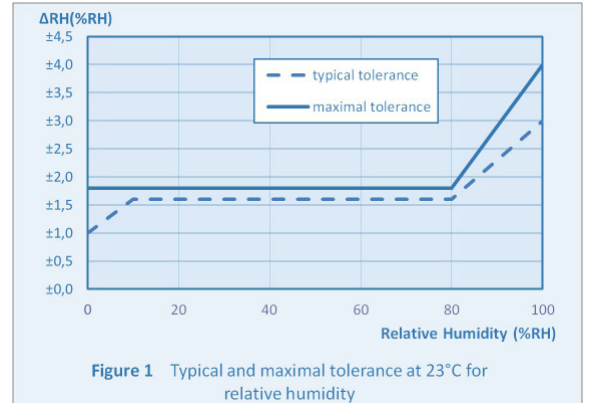



Mechanical Dimensions

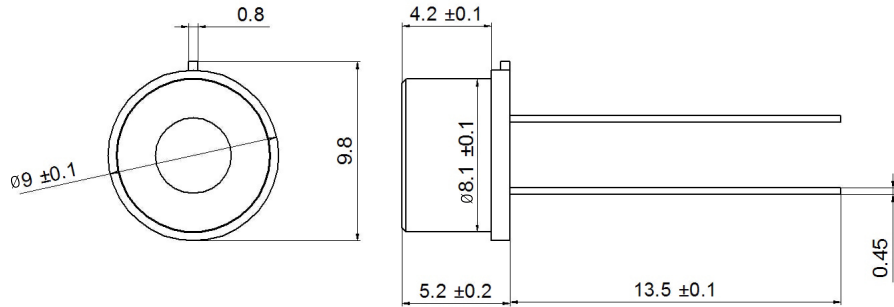

Pin Assignment

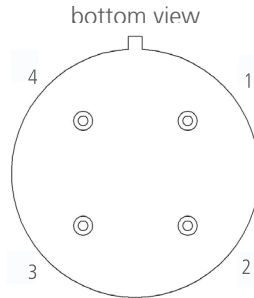

1	2	3	4
SCL	VCC	GND	SDA

3.1 Mounting Instructions

The media compatibility of the sensor, housing and sealing materials are to be checked and kept suitable as per the application. The housing and the assembly must be so constructed that it can withstand the application pressure multiplied by the factor of safety. In case of dynamic applications in the upper pressure range, an additional extra factor is to be taken into account for the material fatigue. The assembly must be done stress free. This should remain valid for the entire temperature range, considering the different coefficients of expansion between the sensor housing and the opening. The support from top may be provided only in the boundary area. The upper mounting ring must rest upon flat.

3.2 Sealing Rings

The most frequent error in case of a pressure resistant assembly is the loss of sealing. Therefore, this is the point where high attention is to be given. Standard sealing rings in the form of O-rings are available in the market, which are offered by different manufacturers. A typical dimension is, for example, 7 x 1 mm. The material is dependent on the application, hence due to qualitative reasons, high grade options of VITON or FPM are recommended, which are also resistant to ageing and temperature exposure.

3.3 Construction Recommendations

These recommendations for construction are to be understood only as assistance for your own construction. The dimensioning of the components in each case is to be decided suiting to the application and checked. Please also consider the fitment and application guidelines of the O-ring manufacturer.



Version 1

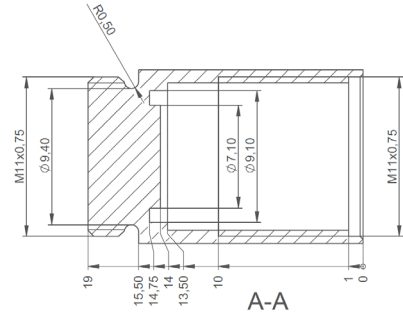
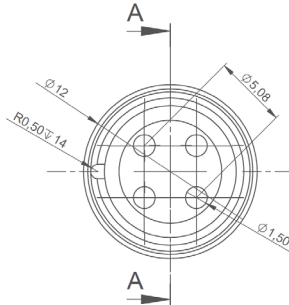
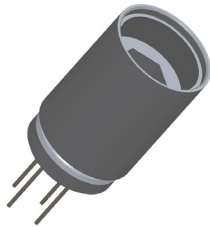

Version 2

Legal Notice: The recommendations for construction are unbinding; alterations are possible in the recommendations at any time without prior notice. Any liability on our part for damages of any kind is excluded.

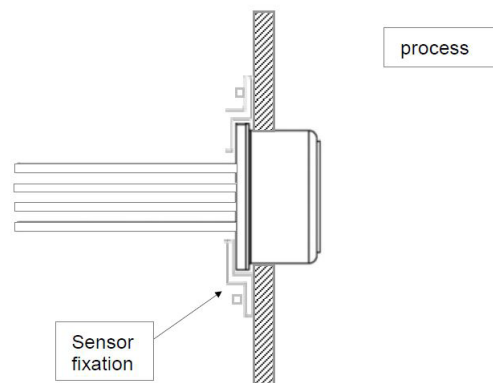

I²C Protocol Description

4.1 I²C Interface and Timing

For integration with a micro-controller, the humidity module has an I²C-compatible interface which supports both 100 kHz and 400 kHz bit rates. The I²C slave address is programmed by default on 0x28 and can be adjusted in the entire address range (0x00 to 0x7F). Hence, up to 126 humidity modules can be operated on a single I²C-Bus.

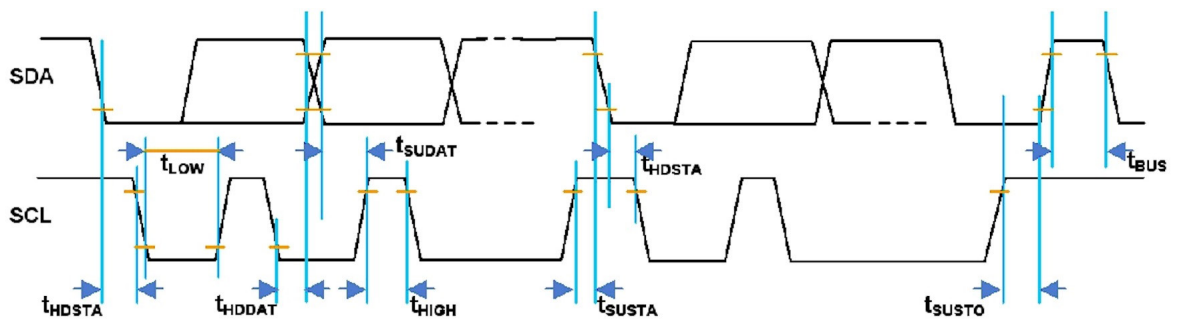



Parameter	Symbol	Min	Max	Unit
SCL clock frequency	fSCL	100	400	kHz
Start condition hold time relative to SCL edge	tHDSTA	0.1		µs
Minimum SCL clock low width 1	tLOW	0.6		µs
Minimum SCL clock high width 1	tHIGH	0.6		µs
Start condition setup time relative to SCL edge	tSUSTA	0.1		µs
Data hold time on SDA relative to SCL edge	tHDDAT	0		µs
Data setup time on SDA relative to SCL edge	tSUDAT	0.1		µs
Stop condition setup time on SCL	tSUSTO	0.1		µs
Bus free time between stop condition and start condition	tBUS	1		µs

There are two I²C commands for the user to access the humidity module:

Command	Description
‚Data Fetch‘ (DF)	Fetch the last measured value of Humidity / Temperature
‚Measuring Request‘ (MR)	Start a measuring cycle

In the initial condition, the humidity module is in sleep mode to minimize the current consumption. A new measurement is carried out only after the command measuring request (MR) is received. Access to the status bits and measured values is made by the data fetch (DF) command. Valid data can be fetched only when a measurement cycle (ASIC conversion) is complete. User must wait for the measurement to complete before performing the DF. The status bit of the DF can be used to tell whether the data is valid or stale, but polling for the result must not be done before the time required for conversion has elapsed. The conversion time is between 60 and 100 milliseconds.

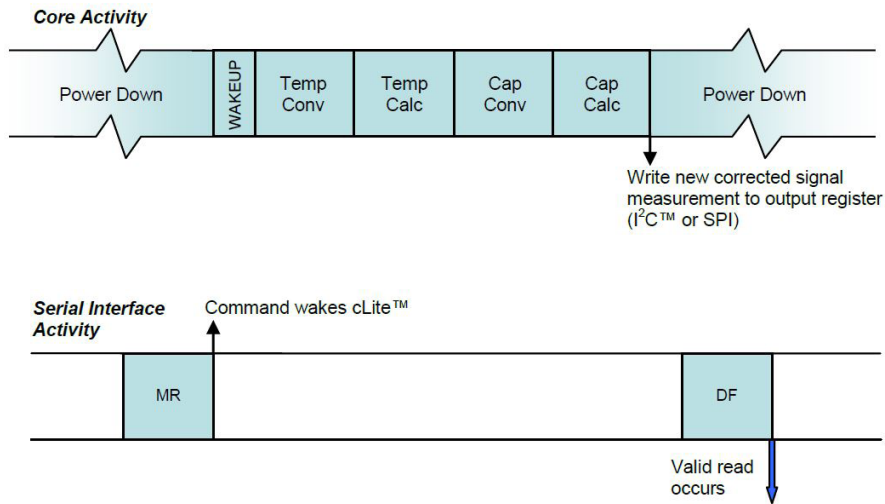

4.2 MR (Measurement Requests)

By a measurement request command, the sleep mode is terminated and the humidity module executes a measurement cycle. The measuring cycle begins with the temperature measurement, followed by humidity measurement, digital signal processing (linearizing, temperature compensation) and finally writes the processed measured values into the output register.



I²C MR - Measurement Request: Slave starts a measurement cycle

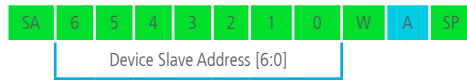

 Master	SA Start condition	A Acknowledge
 Slave (HYT)	W Write bit	N Not acknowledge
	R Read bit	SP Stop condition

4.3 DF (Data Fetch)

The data fetch command serves to read the output register. The DF command is sent by the master to the humidity module (slave) and begins with the 7 Bit slave address. The 8th bit is 1 (= read). The humidity module sends back an acknowledgement in case of correct addressing. The humidity and temperature value are encoded in two bytes each. If only the humidity value shall be read, the master can issue a stop condition after two bytes. The illustration below *PC DF - 2 Bytes: Slave returns only capacitance data to the master in 2 bytes* illustrates the transfer. The first two bits contain two status bit [31:30], which must be masked for the humidity value. The last two bit [1:0] are not used and must also be masked off.

In case of a failure, the slave issues not acknowledgement.

PC DF - 2 Bytes: Slave returns only capacitance data to the master in 2 bytes

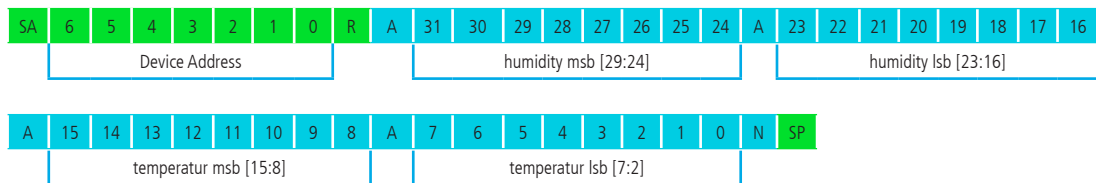

 Master	SA Start condition	A Acknowledge
 Slave (HYT)	W Write bit	N Not acknowledge
	R Read bit	SP Stop condition

4.4 Scaling of Measurement Values

T_{raw} and RH_{raw} are the digital 16 bit values submitted by the sensor.

Humidity signal (2 bytes):

The first top bits are status bits with following relevance:

- Bit 15: CMode Bit, if 1 – element is in command mode
- Bit 14: Stale bit, if 1 – no new value has been created since the last reading.



To mask the 2 top status bits in a 16 bit value, it will be linked logically with 3FFF and AND. The remaining 14 bit represents the measured value. The masked value data now have to be scaled into physical measurement units:

Humidity values will be calculated as follows:

$$RH [\%] = (100 / (2^{14} - 1)) * RH_{raw}$$

0x0 complies with 0 % RH

0x3FFF complies with 100 % RH

$RH_{raw} = 0x0000$ to $0x3FFF$ (Hex) or 0 to 16383 (Dec)

Temperature signal (2 bytes):

The bits 15 to 2 represent the 14 bit measured value. Bit 1 and 0 are not used. The value data now have to be scaled into physical measurement units:

Temperature values will be calculated as follows:

$$T [^{\circ}C] = (165 / (2^{14} - 1)) * T_{raw} - 40$$

0x0 complies with -40 °C

0x3FFF complies with +125 °C

$T_{raw} = 0x0000$ to $0x3FFF$ (Hex) or 0 to 16383 (Dec)

C-Code examples are available upon request.

Example:

	Byte 1	Byte 2	Byte 3	Byte 4
	31 dec	109 dec	96 dec	72 dec
bin	0001.1111	0110.1101	0110.0000	0100.1000
	Humidity 14 bit right-adjusted		Temperature 14 bit left-adjusted	
hex	1F6D		1812	
dec	8045 x 100/16383 =		6162 x 165/16383 - 40 =	
	49.1 % RH		22.06 °C	



4.5 I²C pull up resistor

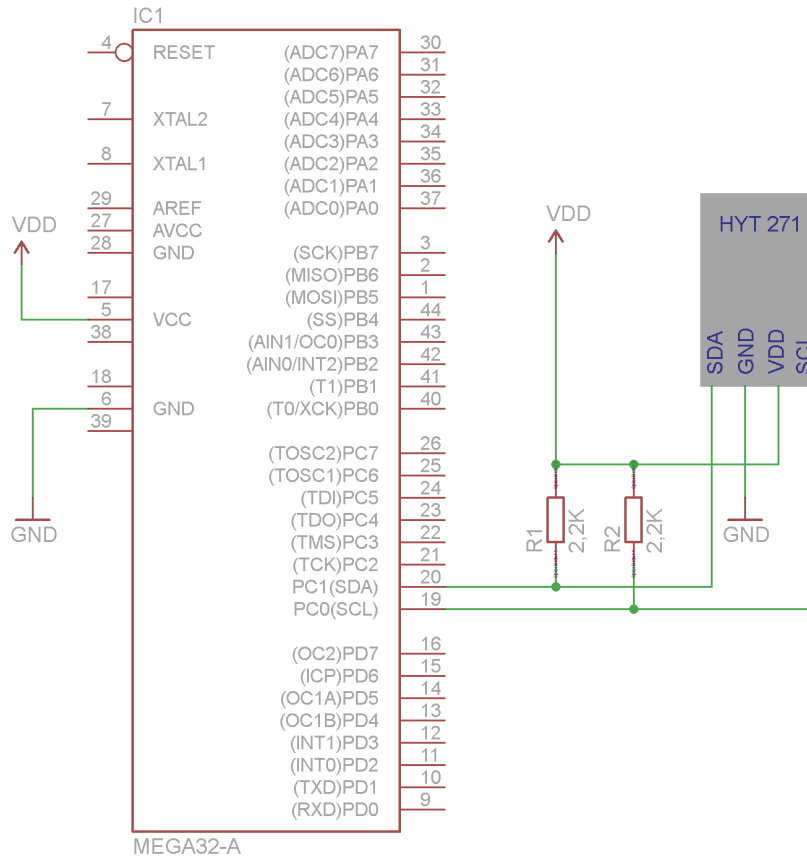

I²C Address Change

To change the I²C-address of the sensor module, the module must be switched into the Command-Mode. The switching is performed by sending the start-command-mode message over I²C-bus no later than 10 ms after Power-On reset. Each command-mode message is 4 byte long, like shown in table 1.

S	6	5	4	3	2	1	0	W	A	7	6	5	4	3	2	1	0	A	7	6	5	4	3	2	1	0	A	P								
S	0	1	0	1	0	0	0	0	A	C	C	C	C	C	C	C	C	A	D	D	D	D	D	D	D	D	A	D	D	D	D	D	D	D	A	P
Slave Address									Command Byte									Command Data [15:8]								Command Data [7:0]										

Table 1

Slave Address:	0x28	default value
Command-Byte:	0xA0	start command-mode
	0x1C	read configurations parameter that includes the I ² C-address
	0x5C	write configurations parameter that includes the I ² C-address
	0x80	end of command-mode, start normal-mode

At writing access both command data bytes contains the data, at reading access both data bytes must be set to 0x00. The response to the command-mode message can be read out by a Data-Fetch. The response time of the command-mode messages are 100 µs.



Table 2 shows the response to the start of the command-mode.

S	6	5	4	3	2	1	0	R	A	7	6	5	4	3	2	1	0	N	P
S	0	1	0	1	0	0	0	0	A	S	S	D	D	D	D	R	R	N	P
	Slave Address									Status	Diagnostics					Response			

Table 2

Status:	10 _b	command-mode
	01 _b	stale
Diagnostic:	xxx1 _b	corrected EEPROM-error
	xx1x _b	uncorrectable EEPROM-error
	x1xx _b	RAM Parity error
	1xxx _b	configuration error
Response:	00 _b	busy
	01 _b	positive acknowledge
	10 _b	negative acknowledge

Table 3 shows the response to the read out of the I²C-address.

S	6	5	4	3	2	1	0	R	A	7	6	5	4	3	2	1	0	A	7	6	5	4	3	2	1	0	A	7	6	5	4	3	2	1	0	A	P	
S	0	1	0	1	0	0	0	0	A	S	S	D	D	D	D	R	R	A	E	E	E	E	E	E	E	E	E	A	E	E	E	E	E	E	E	E	A	P
	Slave Address									Status	Diagnostics					Response		EEPROM Data (15:8)							EEPROM Data (7:0)													

Table 3

Status:	see table 2 on page 16
Diagnostic:	see table 2 on page 16
Response:	see table 2 on page 16
EEPROM-Data:	content of the memory

The response to the command byte 0x1C contains the I²C-address in bitposition 6:0, default value is 0101000b. The old I²C-address is valid until the module is in command-mode.

The following table shows a complete process of reading and writing back of the I²C-address.

Power – On Reset

S	0x50	A	0xA0	A	0x00	A	0x00	N	P	Start Command – Mode
S	0x51	A	0x81	N	P					Response (ACK)
S	0x50	A	0x1C	A	0x00	A	0x00	N	P	Read out Data Bytes with I ² C-address
S	0x51	A	0x81	A	Highbyte	A	Lowbyte	N	P	Response
Write the new address into the bits 6:0 of the lowbyte.										
S	0x50	A	0x5C	A	Highbyte	A	Lowbyte	N	P	Write back Data Bytes with I ² C-address
S	0x51	A	0x81	N	P					Reponse (ACK)
S	0x50	A	0x80	A	0x00	A	0x00	N	P	Start normaler mode

or alternatively Power – Off



The following table shows the I²C timing.

Command Byte	Third and Fourth Bytes	Description	Response Time ⁵⁵
8 Command Bits	16 Data Bits (Hex)		
00 _H to 1F _H	0000 _H	EEPROM Read of addresses 00 _H to 1F _H . After this command has been sent and executed, a data fetch must be performed	100 μs
40 _H to 5F _H	YYYY _H (Y = data)	Write to EEPROM addresses 00 _H to 1F _H . The 2 bytes of data will be written to the address specified in the 6 LSBs of the command byte	12 ms
80 _H	0000 _H	Start_NOM Ends Command Mode and transitions to Normal Operation Mode	Length of initial conversions depends on temperature and capacitance resolution settings and the capacitance „mult“ setting
A0 _H	0000 _H	Start_CM Start Command Mode: used to enter the command interpreting mode. Start_CM is only valid during the power-on command window	100 μs
B0 _H	0000 _H	Get revision Get the revision of the part. After this command has been sent and executed, a data fetch must be performed	100 μs

5.1 Step by Step - I²C Address Change

- Power-on-reset
- Within 10 ms, send command 0XA0 (start command mode) through I²C bus. The default 7 bit I²C address is 0x28. In I²C write mode, the bit "W" shall be 0

0x50	0xA0	0x00	0x00	Send Start-Command-Mode
0x51				Response fetch, the bit "R" is 1

If the response is not 0x81, then you did not enter the command mode successfully. If the sensor can be read out correctly, but entering command mode failed, please try to reduce your clock frequency to below 100kHz, and then repeat step 1) and 2).
- First try to read the configuration parameters stored inside EEPROM. If entering command-mode is successful, the content can be read out successfully, otherwise start from step 1)

0x50	0X1C	0X00	0X00	Send read register 1C command. Register (1C) includes the I ² C address
0x51				Read out data bytes with I ² C address
- If the response is not 0x81 0x00 0x28, then you did not read successfully
Change I²C address by sending the following command:

0x50	0x5C	0x00	0x31	Change I ² C address into 0x31
------	------	------	------	---

Repeat 3) to confirm whether the I²C address is successfully changed. If successful, the response is 0x81 0x00 and 0x31
- Power-off, if 1), 2), 3) and 4) failed



HYT Labkit

The labkit was developed as a Plug & Play tool for a fast evaluation of the HYT digital humidity sensors. The ready-to-use system consists of a PC-adapter with an USB connecting wire, a connection adapter with plugs for all product variants, a connection cable and an easy to operate, user-friendly WINDOWS software CD-ROM. The recording of the measured values and the graphic presentation is carried out with the help of a PC.

The provided software PCLOG enables the online visualization, records all measured values as graphics and stores the measured values and data in a file. With the PCLOG software, it is easy to test the behavior of the sensor in an application. Additionally, the integrated PCLOG hx-computer provides the calculation and display of dew point, absolute humidity, vapor pressure, saturated vapor pressure, enthalpy and many other meteorological parameters. The operating manual for the software and detailed instructions for installation is available on the data medium.

Note: The Labkit does not contain any sensors. The sensors must be ordered separately.

6.1 WINDOWS-Software RECORDER

With the help of the Windows-software RECORDER, included in the labkit, the measured values (relative humidity and temperature) can be recorded through the USB-interface and stored on the PC. The stored CSV format file is compatible with all spreadsheet programs, through which it is possible to further process, statistically evaluate or visualize the measured data. Additionally, the PC-software also calculates the dew point, absolute humidity, enthalpy and vapor pressure from the measured values. The calculated parameters can also be stored.

System requirements: WIN 98, WIN 2000, WIN XP or WIN 7, USB-Interface.

Important information: The USB should be connected to the PC only after installing the software. This simplifies the driver installation and enables the „Plug & Play“ feature. Windows 7 automatically installs the required drivers.

Installation: A detailed installation instruction is provided on the CD, which automatically starts when inserting the CD (prerequisites: Internet-Explorer 5.0 or higher). Follow these instructions for installation.

Manual installation: Insert the enclosed CD into the drive and select „Run“ in the start-menu. Then browse to select the file ‚setup.exe‘ under the path LW:\software\RECORDER\Deu. Follow the instructions of the installation program.

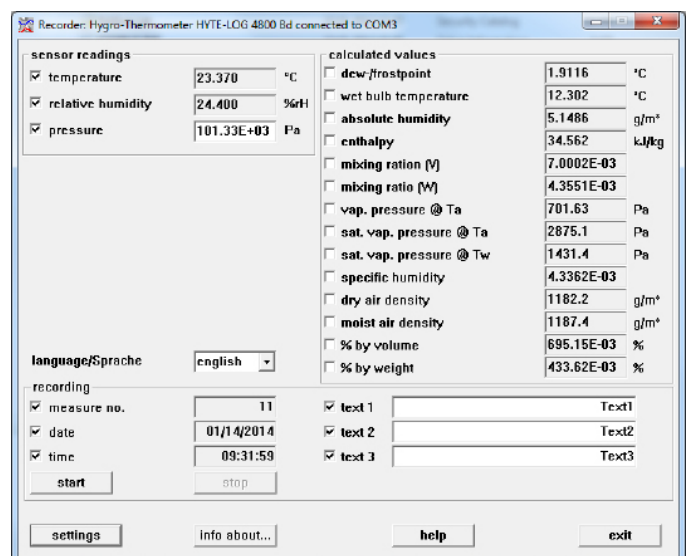

First time operation: Connect the labkit to the USB-interface. After the first software run, go to the menu option „settings“ and select the device type as „HYTELOG 4800“ . Then select the type of interface to be used under „connections“ (Note: Mention the virtual COM-port specified during driver installation). The remaining settings (Data rate, Parity, Start and Stop bit) are automatically selected and need not to be changed. If the connection is established, the data communication appears on the window. Then select „Close“. The current settings will be stored.

If you are not able to establish a data link between the PC and the measuring probe, please check the USB cable connection to the PC. Further information on debugging is available under FAQ's on the CD.



Data recording: First activate the checkbox of all the measurement channels that are to be recorded. In ,Text 1' and ,Text 2', a description can be entered, which will appear on the header of the file. The data is recorded in the file, which is declared as a path under the settings. The recording begins with the ,Start' button.

EXCEL™: The stored file is compatible with CSVformatting. In order to display the measured data, it is possible to use graphic tools, for example, diagram -assistant. However, other programs can also be used to graphically present or evaluate the measured data.

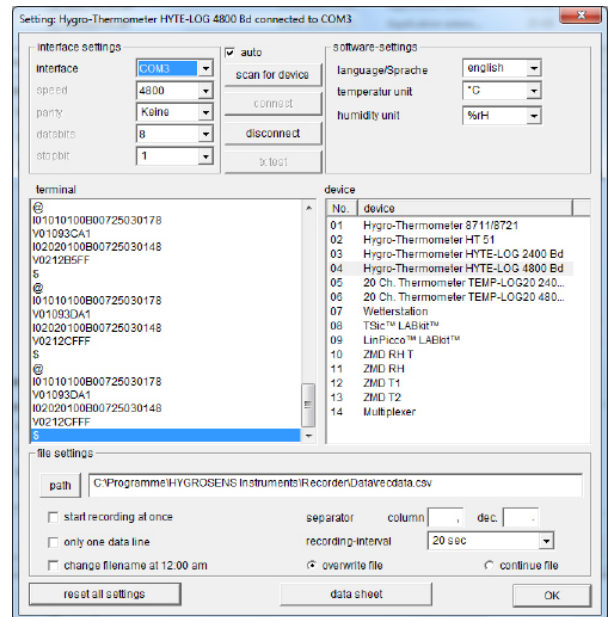

6.2 Correct Hardware Installation

Plug the HYT sensors into the sensor adapter as shown in the illustration. Please ensure the correct plug direction and that the pins are correctly inserted into the socket.

6.3 Sensor Connection

Applicable for HYT271:



Applicable for HYT221:

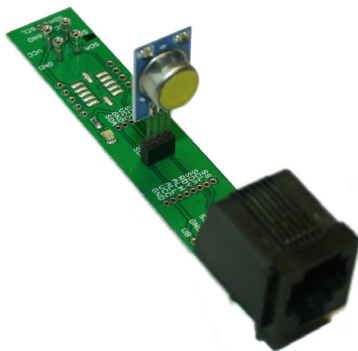



Applicable for HYT939:

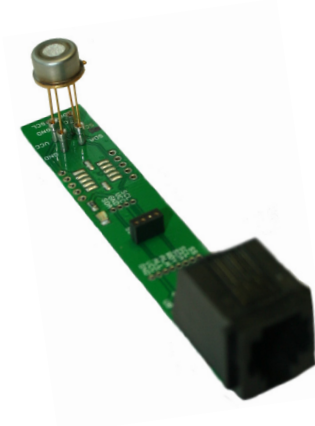

Place the sensor as described into the adapter board and then connect it with the help of the connection leads provided with the PC adapter. Then connect the PC adapter through the USB cable to the PC or your notebook.

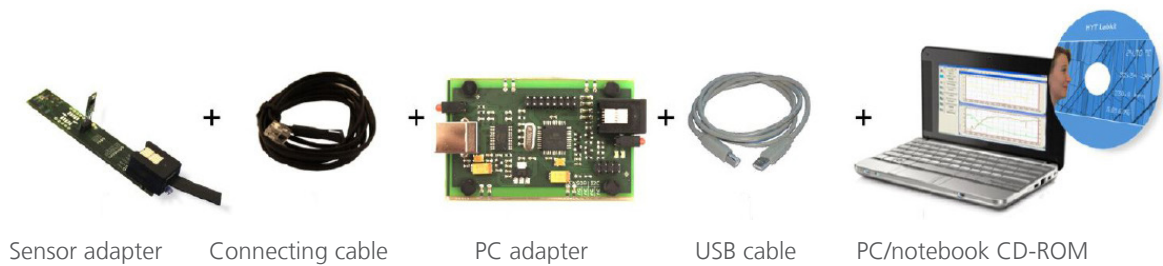

6.4 Internal Data Transfer

The communication between the PC and the measuring probe takes place serially by means of COM port emulation. Therefore, it is easy to link the measurement to your own software. (Programming knowledge presupposed). For the USB UART FTDI 232 used, drivers are available for Linux, MAC or PDAs. Further information is available on www.ftdichip.com. The interface works on a data rate of 4800 Baud, 8 data bits, no parity and one stop-bit.

6.5 Software PCLOG

6.5.1 Visualization and Documentation

The most important feature of the software is the graphic visualization of all measured and recorded channels as a y/t chart (online scriber function). By means of Click & Drag, the window section can be enlarged and the time or temperature axis can be scaled as required. Multiple recording windows can be opened simultaneously. Moreover, multiple physical parameters can be presented in each window in which the axis definition, color scheme, channel description, icons and many other options can be configured. The clipboard serves as the export function for transfer of the measured data series into a spreadsheet calculation with the help of user friendly wizards. All tables and graphic presentations can be plotted or printed in color.

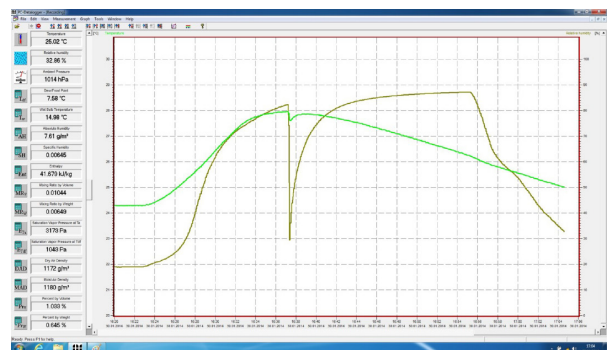



6.5.2 Installation of Software PCLOG

The software PCLOG is included in the labkit. Open and start the file "setup.exe" in the path ...Software\PCLog\deu' on the enclosed CD. Please follow the installation instruction. The software is installed automatically.

Start the software PCLOG and open the option „Extras“ in the menu and click on „Activation“. The above dialogue box will open

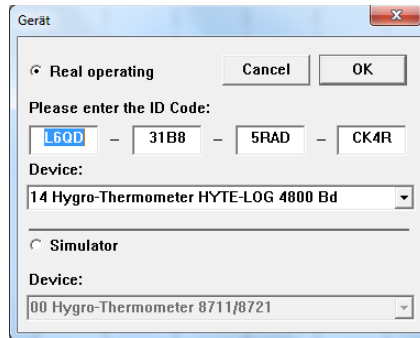

Now for the „Device“, select the device driver „14 Hygro-Thermometer HYTE-LOG 4800 Bd“. The activation code will be registered automatically. Confirm the dialogue with ‚OK‘. Now open the option „Extras“ in the menu and then go to the sub-menu „Interface“. Put in the corresponding interface.

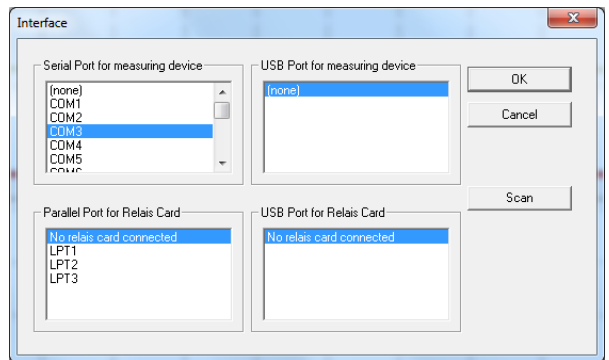

The user interface – if not known – can be determined in the device manager under Windows. (Control panel P System P Hardware P Device Manager P Connections) The PCLOG start screen appears. The measured values of the sensors are displayed on the left side.

The measurement begins in the menu with "Measurement" P "Start recording". Confirm the window selection with OK.

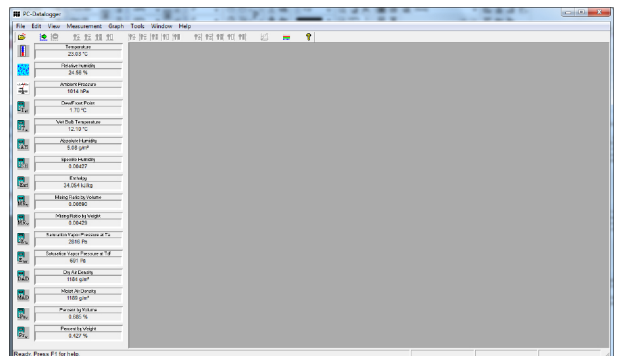

Now click on the thermometer icon and the icon with the water drops in the left side panel. The corresponding measuring curves are displayed.

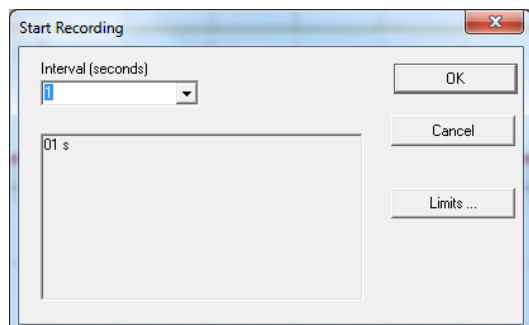



LCD Module for HYT271

The Hygrochip LCD module is an easy to use demonstration and evaluation kit for HYT sensors. The measured values of the connected sensor can be displayed on the display. If an external power supply is used the measured values are also available on the analog outputs.

7.1 Pin Designation

Top

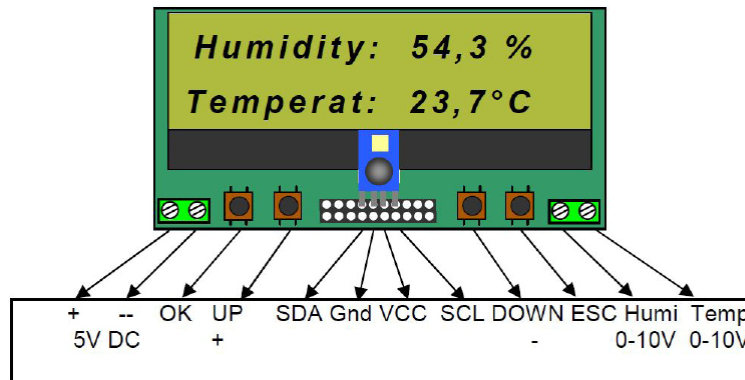

Bottom

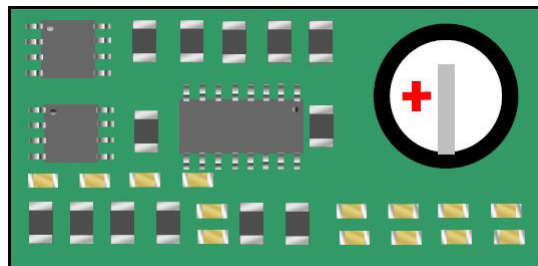



7.2 Description of Operation

After power on, the module shows the following information for 2 seconds:

HYT271 – Module
www.ist – ag.com

After that it changes to the measurement mode and shows the values of relative humidity and temperature.

Humidity 54,3 %
Temperat 23,7 °C

The following configuration options are available in addition to the measured values:

1. CONFIGURATION
Address 0xHH (0x00 – 0x7F)
2. CONFIGURATION
Corr-Temp. 0.0K (-1,0K – 1,0K)
3. CONFIGURATION
Corr-Humid 0.0% (-1,0% - 1,0%)

Switching between the standard and configuration menus is possible by use of the UP and DOWN buttons.

By pressing the OK button into a configuration menu the software goes into the input mode. This mode is shown by the cursor and blinking of the last character. In the input mode the function of UP / DOWN will be changed to +/- . The value can be changed into the limits by pressing the +/- buttons.

The new value is stored by pressing the OK button.

By pressing the ESC button the entered value is rejected and the software leaves the input mode.



Innovative Sensor Technology IST AG, Stegrütistrasse 14, 9642 Ebnat-Kappel, Switzerland
Phone: +41 71 992 01 00 | Fax: +41 71 992 01 99 | Email: info@ist-ag.com | www.ist-ag.com