



life.augmented

Solutions for Smarter Mobility Automotive Applications Overview



Contents

- 3 Smart Mobility
- 4 ADAS
- 6 Automotive motor control
- 8 Body and Convenience
- 10 Chassis and Safety
- 12 Electro-Mobility
- 14 Powertrain for ICE
- 16 In-vehicle Infotainment
- 18 Telematics and Networking
- 20 Mobility Services
- 22 Key Technologies
- 26 Development Tools

Smart Mobility

It is estimated that 80% of all innovations in the automotive industry today are directly or indirectly enabled by electronics. With vehicle functionality improving with every new model this means a continuous increase in the semiconductor content per car.

With over 30 years' experience in automotive electronics, ST is a solid, innovative, and reliable partner with whom to build the future of transportation.

ST's Smart Mobility products and solutions are making driving safer, greener and more connected through the combination of several of our technologies.

80%
of all innovations
in the automotive
industry today
are enabled by
electronics



SAFER

Driving is safer thanks to our Advanced Driver Assistance Systems (ADAS) – vision processing, radar, imaging and sensors, as well as our adaptive lighting systems, user display and monitoring technologies.

GREENER

Driving is greener with our automotive processors for engine management systems, high-efficiency smart power electronics at the heart of all automotive sub-systems and devices for hybrid and electric vehicle applications.

MORE CONNECTED

Vehicles are more connected using our infotainment and telematics processors and sensors, as well as our radio tuners and amplifiers, positioning technologies, and secure vehicle-to-vehicle (V2V) and vehicle-to infrastructure (V2X) connectivity solutions.

ST supports a wide range of automotive applications, from Powertrain for ICE, Chassis and Safety, Body and Convenience to Telematics and Infotainment, paving the way to the new era of car electrification, advanced driving systems and secure car connectivity.

ADAS

Advanced Driver Assistance Systems



Advanced Driver Assistance Systems (ADAS) aim to drastically reduce road accidents and the associated casualties by helping drivers avoid collisions altogether. These systems react faster than any human, are constantly vigilant, and are already being adopted and deployed across various car segments, from premium to economy models. ADAS systems constantly monitor the vehicle surroundings, alert the driver of hazardous road conditions, and take corrective actions, such as slowing or stopping the vehicle. These systems use inputs from multiple sensors, such as cameras and radars. The fusion of these inputs is processed and the information is delivered to the driver and other parts of the system. The same sensor technologies can be used both in the current ADAS systems and in the upcoming fully autonomous driving systems (level 4 and 5).

Camera-based technologies provide high-reliability and adaptability for a wide-range of driver assistance applications, for example lane keeping, pedestrian detection, traffic sign recognition, rear view camera, driver and passenger monitoring, electronic mirror. Radar-based ADAS uses two different carrier frequencies, 24 GHz for narrowband and 77 GHz for wideband applications, to support features such as blind-spot detection, automatic emergency braking and adaptive cruise control.

ST has a leading-edge product portfolio including Monolithic Microwave Integrated Circuits (MMIC), CMOS High Dynamic Range (HDR) image sensors and advanced Image Signal Processors (ISP) with dedicated HW engines for video analytics and lens correction. ST also has a wide range of Automotive Microcontrollers, Security ICs and Power Management ICs to ensure the reliability of the mission-critical ADAS systems.

ADAS

systems constantly monitor the vehicle surroundings, alert the driver of hazardous road conditions, and take corrective actions

KEY APPLICATIONS

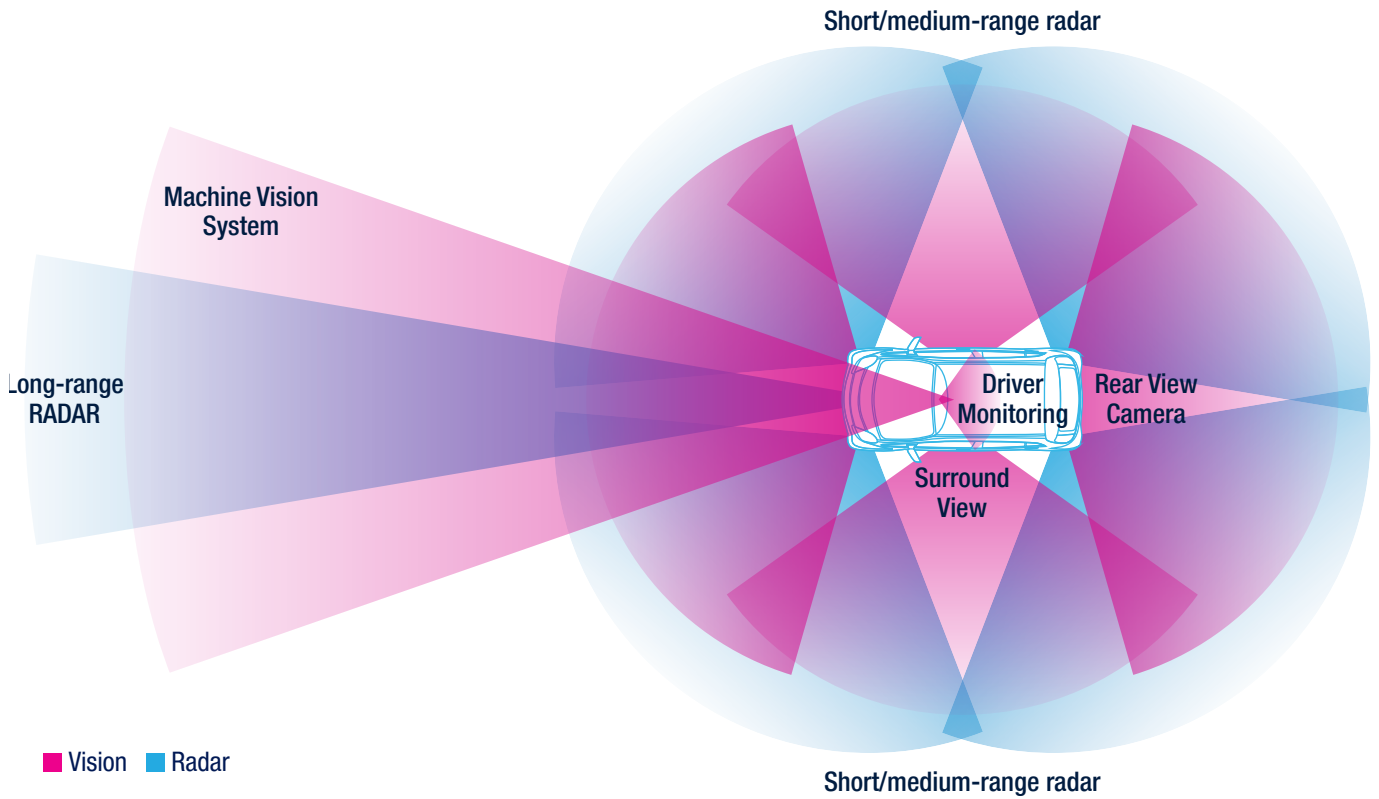

SOLUTIONS

ST's key products and solutions for ADAS applications include:

Image Signal Processor	Power Management	EOS & ESD protection, EMI filters	32-bit Automotive Microcontrollers
Image Sensor	Automotive Radar Transceiver	Ultrafast and Schottky diodes	
HW & SW development and evaluation tools			



FIND OUT MORE

www.st.com/adas

24GHz & 77GHz Radar
Rear View Camera
High Resolution Thermal Camera

Driver Monitoring System (DMS)
In-Vehicle High Speed Network

Motor Control

Today, Motor Control is a key focus segment for automotive applications, from conventional body & convenience and chassis & safety to smart and more innovative domains like electro-mobility and e-powertrains.

Electric motors are today omnipresent inside every vehicle segment. In battery electric vehicles, an electric traction motor even replaces the combustion engine. And thanks to smarter starter generator and e-turbochargers systems, 48 V small electric motors play a crucial role in reducing CO₂ emissions.

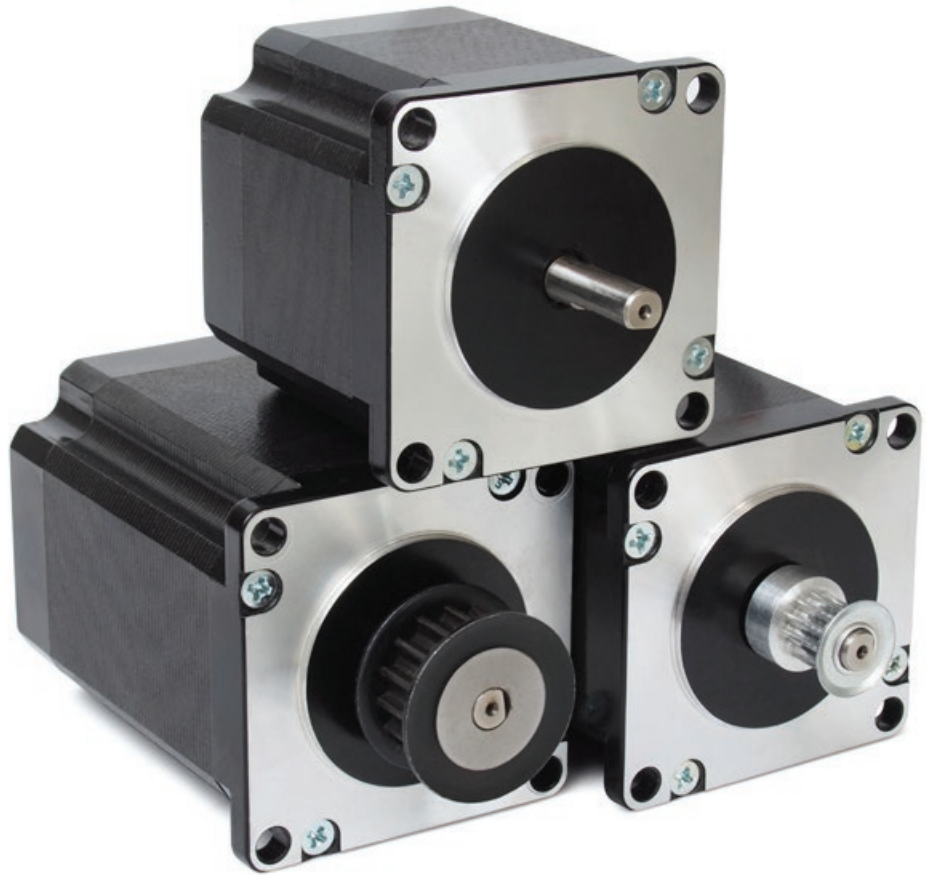

ST is definitely the right partner with whom to develop reliable and cost-effective solutions for automotive motor control applications.

Developers will appreciate the broadest portfolio dedicated to Motor Control solutions for automotive applications.

Discover our leading-edge portfolio of Automotive-grade motor drivers that can control brushed and brushless DC motors as well as stepper motors.

~100

Motors can be present
in a premium vehicle

KEY APPLICATIONS

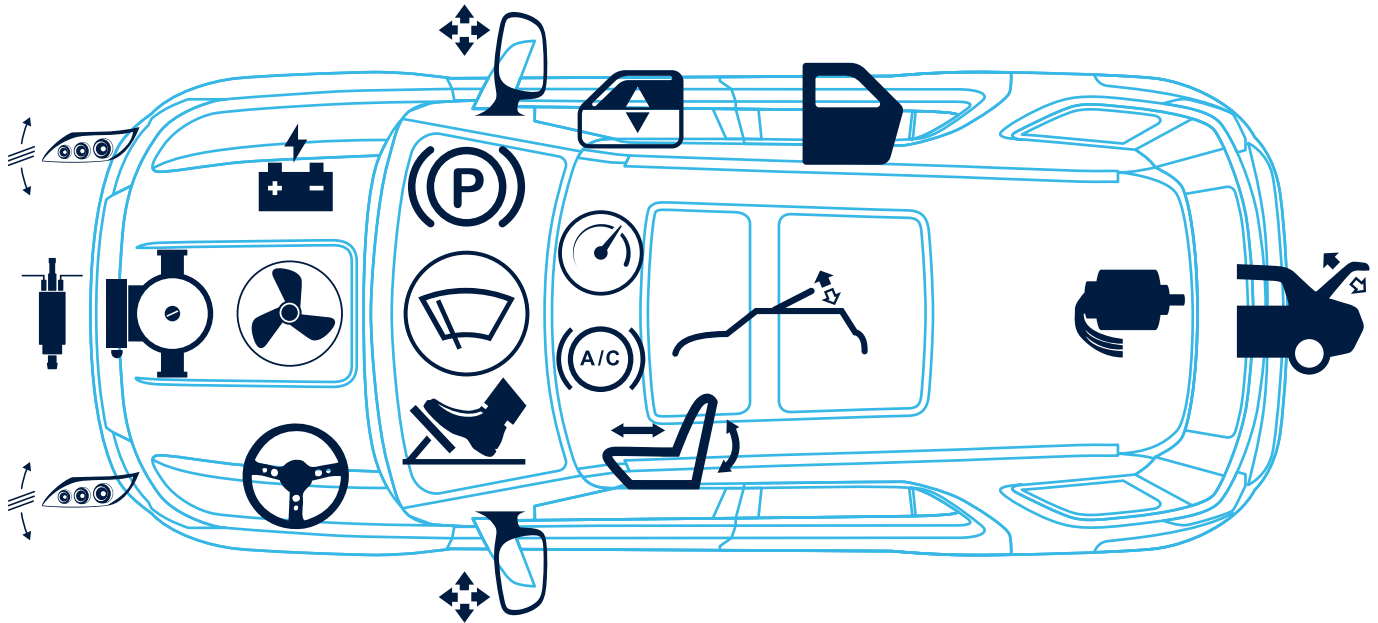

SOLUTIONS

ST's key functions and solutions for Motor Control include:

Fan	Transmission	Traction	Starter generator	Turbo charger	Electric pumps (water, oil, fuel)
Wipers	Seat positioning	Window lift	Door lock	Mirror	Head-up display
Car trunk	Electric parking brake	Turbo waste gate	Throttle valve	Sunroof	HVAC blower and flaps
Electric power steering	Brake booster	Active suspension	Analog gauges	Adaptive lighting	Idle actuator



FIND OUT MORE

www.st.com/auto-motorcontrol

Automotive Bipolar Stepper Motor
 Automotive BLDC Motor
 Automotive Brushed DC Motor

Body and Convenience



Car body and convenience applications are evolving to increase the comfort of both drivers and passengers. Vehicle manufacturers need solutions that have the flexibility to cover a wide range of car models and a broad range of options. These solutions need to communicate increasing amounts of data to enable decentralized control, enhanced functional safety levels, as well as efficient diagnostic and maintenance capabilities.

Body control modules (BCM) are increasingly being used to control multiple vehicle functions, with integration becoming a key discriminator. Cost-effective flexible semiconductor solutions for BCMs depend upon having the right technology for the application needs.

ST has the broadest product portfolio dedicated to body and convenience solutions, covering interior and exterior lighting systems for bulbs, xenon HID and LEDs and drive controllers for stepper, brushed and brushless DC motors. We provide complete solutions for seat positioning and trunk, mirror, window, wiper and lock control as well as everything required for automatic climate control systems. In addition, we supply connectivity solutions to link all the sub-systems together.

Our proven automotive-grade Smart Power technologies, Bipolar-CMOS-DMOS (BCD) and VIPower can combine multiple functions on a single chip to provide unprecedented levels of integration. Our CMOS and discrete power technologies complement the Smart Power technologies and our wide range of automotive packages completes the offer.

KEY APPLICATIONS

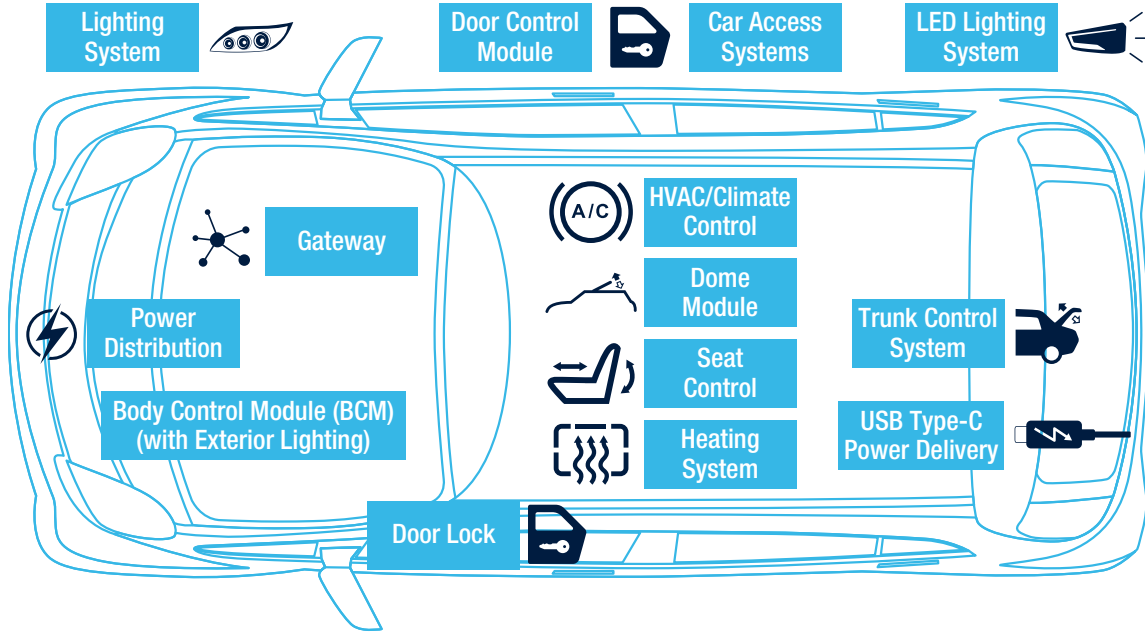

SOLUTIONS

ST's key products and solutions for Body and Convenience applications include:

VIPower and BCD Actuators, Motor Control and LED drivers	Sensors	EEPROM	Power Management	EOS & ESD protection, EMI filters	32-bit Automotive Microcontrollers
	NFC	Connectivity	Power Diode, MOSFET & IGBT	Dedicated Door Module ICs	

HW & SW development and evaluation tools



FIND OUT MORE

www.st.com/body-and-convenience

Body Control Module
 USB Type-C Power Delivery
 Dome Module
 Door Lock
 Door Control Module

Exterior Lighting
 Automotive Gateway
 Head-up Display (HUD)
 Heating System
 HVAC / Climate Control

LED Lighting System
 Secure Car Access
 Power Distribution
 Seat Control Module
 Trunk Control System

Chassis and Safety



ST
offers a range
of both standard
and dedicated
devices to enable
all chassis and
safety applications

Active and passive safety systems that reduce the risk of accidents, as well as their consequences, are becoming more sophisticated with an increasing electronic component count.

Active safety applications such as electric power steering, electric parking brakes, increasingly rely on sensors, brushed and brushless motors and microcontrollers to improve performance and reliability. Passive applications like seat-belt tensioners and airbags also benefit from the latest technologies.

ST offers a range of both standard and dedicated devices to enable all these chassis and safety applications. In addition to standard low-side, high-side, bridge and pre-drivers, ST offers Smart Power devices for driving solenoids, brushed, brushless and stepper motors; dedicated ICs for actuator driving and one of the industry's broadest ranges of Power MOSFETs whether in traditional Silicon based or new Silicon Carbide (SiC) technology. We also supply System Basis Chips (SBC) for fully integrated smart-power solutions, MEMS accelerometers and gyroscopes combined in a monolithic 6-axis IMU solution, and powerful 32-bit automotive microcontrollers to provide reliable control.

KEY APPLICATIONS

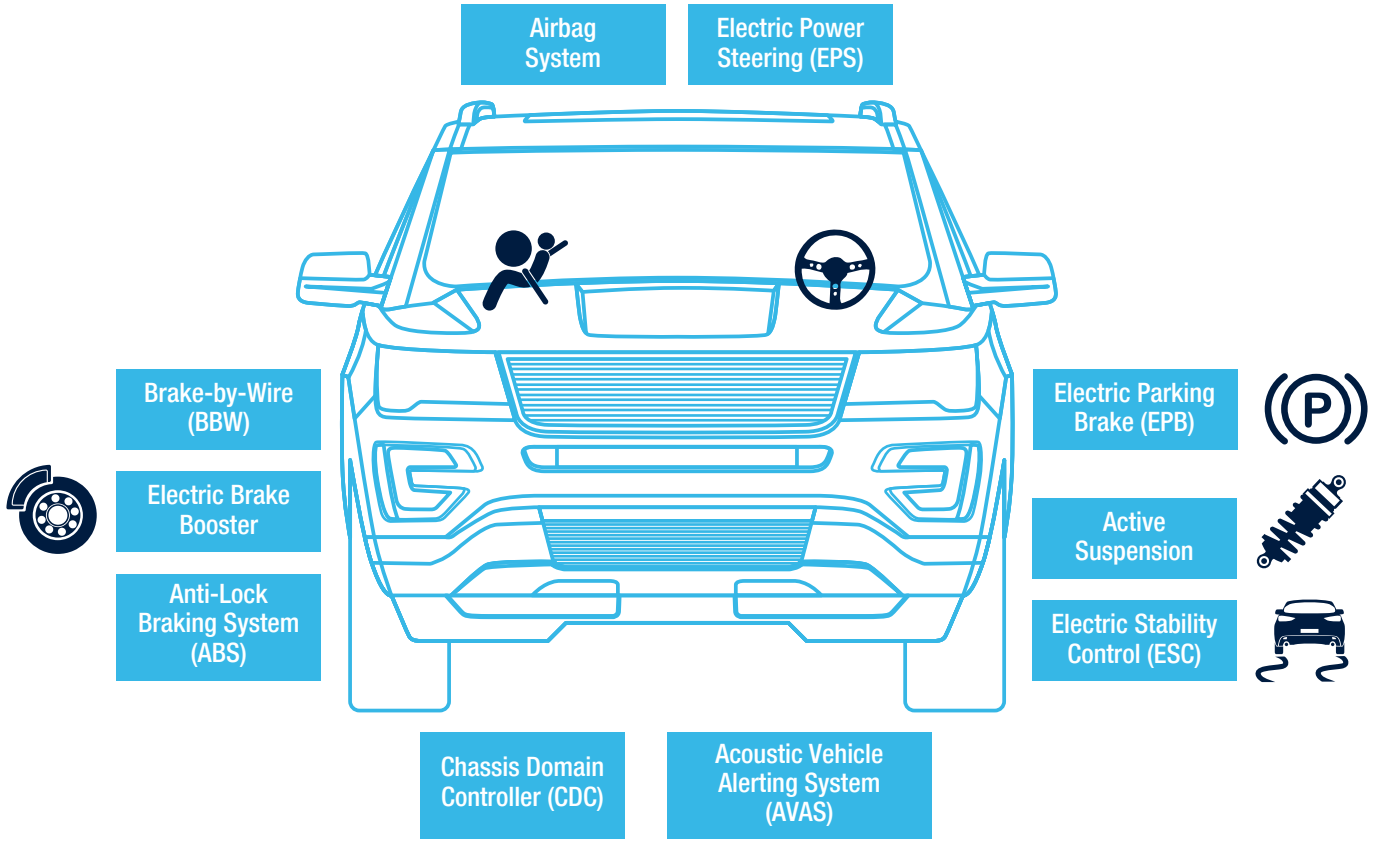

SOLUTIONS

ST's key products and solutions for Chassis and Safety applications include:

VIPower and BCD Actuators and Motor Control	Braking & Airbag Dedicated ICs	Power Management	EOS & ESD protection, EMI filters	32-bit Automotive Microcontrollers
	Power Diode, MOSFET & IGBT	Transceivers and Signal Conditioning	Sensor Interfaces	
HW & SW development and evaluation tools				



FIND OUT MORE
www.st.com/chassis-and-safety

Electric Power Steering
 Electric Parking Brake
 Electric Brake Booster

Airbag System
 Active Suspension
 ABS and ESC

AVAS
 Brake-by-Wire BBW
 Chassis Domain Controller

Electro-Mobility



ST
provides
leading-edge
solutions for
hybrid (HEV), and
battery electric
vehicles (BEV)

The electrification of vehicles is rapidly increasing, driven by the availability of higher performance and more cost-effective battery technologies, and improved mileage as well as ecological awareness, and government incentives and regulation.

ST provides leading-edge solutions for hybrid (HEV), and battery electric vehicles (BEV) based upon proven and innovative technologies and backed up with our extensive power management experience.

Best-in-class silicon and SiC (Silicon Carbide) MOSFETs and diodes, IGBTs, protection components, isolated gate drivers and microcontrollers make up an unrivalled offer for electric vehicle power management. They are available as discrete components, or as part of dedicated system solutions, all in compliance with the AEC-Q100 and AEC-Q101 standards.

Whether you are looking for the cost-effective, yet emission-reducing first step on the electrification ladder with solutions for 48 V systems for mild hybrids, or for the traction inverter, battery management system and on-board charger for a fully electric vehicle, ST has the products you need.

KEY APPLICATIONS

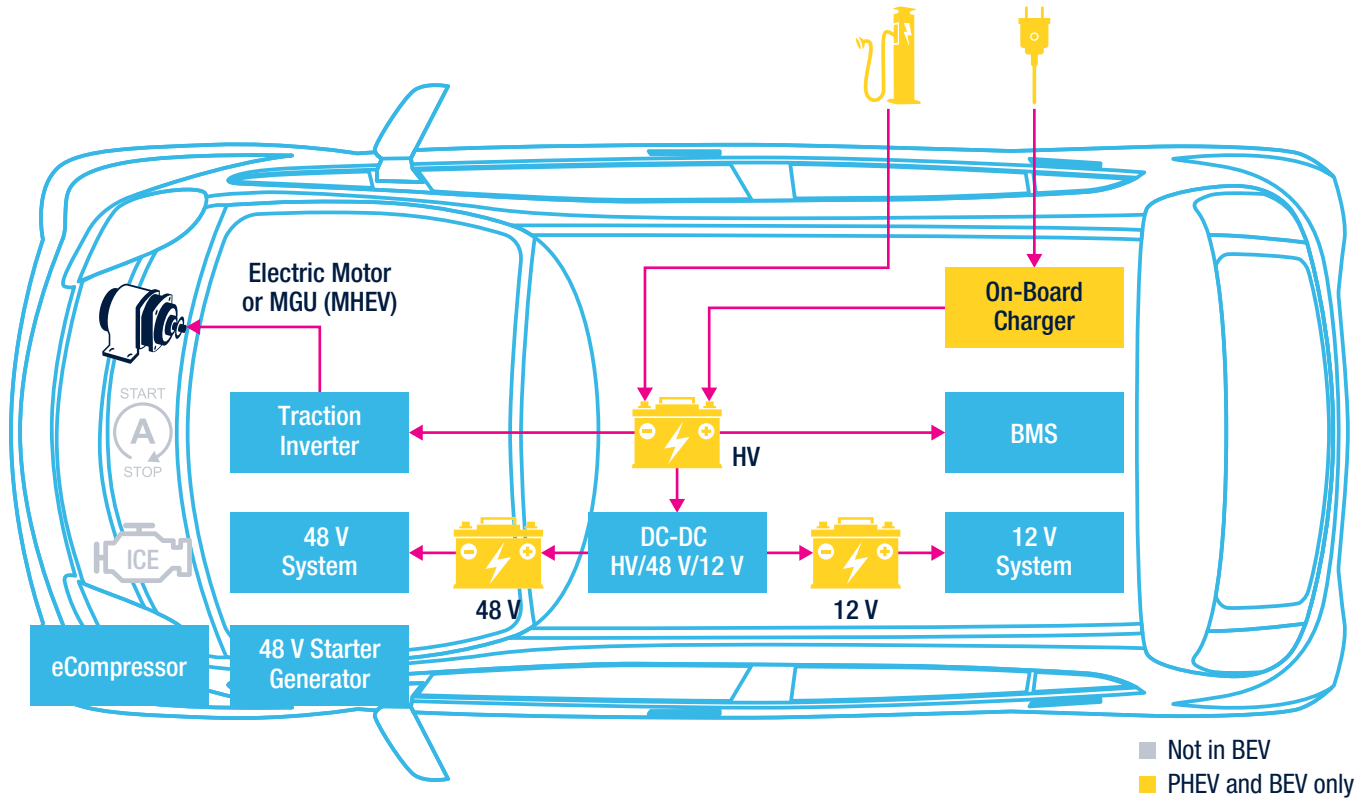

SOLUTIONS

ST's key products and solutions for Electro-Mobility applications include:

SiC MOSFETs and Diodes	Transceivers	Power Modules	Power Management	32-bit Automotive Microcontrollers
Power MOSFETs and IGBTs	Power Diodes and Thyristors	EOS & ESD protection, EMI filters	BCD Integrated and Isolated Drivers	
HW & SW development and evaluation tools				



FIND OUT MORE
www.st.com/electro-mobility

Battery Management System (BMS)
 DC-DC Converter
 Main Inverter (Electric Traction)
 e-Compressor

48 V Electric Supercharger
 On Board Charger (OBC)
 HV Battery Disconnect & Fire-off System
 Bidirectional DC/DC Converter
 48 V Electric Supercharger

Powertrain for ICE



ST
provides
silicon solutions
for Engine
Management

Reducing CO₂ and particle emissions, while increasing engine performance and improving the overall driving experience, requires ever more sophisticated semiconductor-based solutions.

A combination of increased processing power, built-in security and safety features, and innovative power technologies are revolutionizing Internal Combustion Engine (ICE) powertrain applications.

ST provides silicon solutions for a broad range of Engine Management Systems (EMS), from motorcycles to multi-cylinder gasoline direct injection and common-rail diesel engines, as well as for transmission control and actuation. Our broad in-house technology portfolio enables a complete range of solutions, from cost-effective highly integrated systems to solutions meeting the most advanced high-performance application requirements.

Our product portfolio addresses your entire system solution, providing 32-bit automotive microcontrollers, standard low-side, high-side and bridge smart power devices for driving solenoids, DC motors (brushed and brushless), and stepper motors. Dedicated ICs for actuator driving, charging and power management, together with one of the industry's broadest ranges of Power MOSFETs and IGBTs complete the ICE powertrain offer.

KEY APPLICATIONS

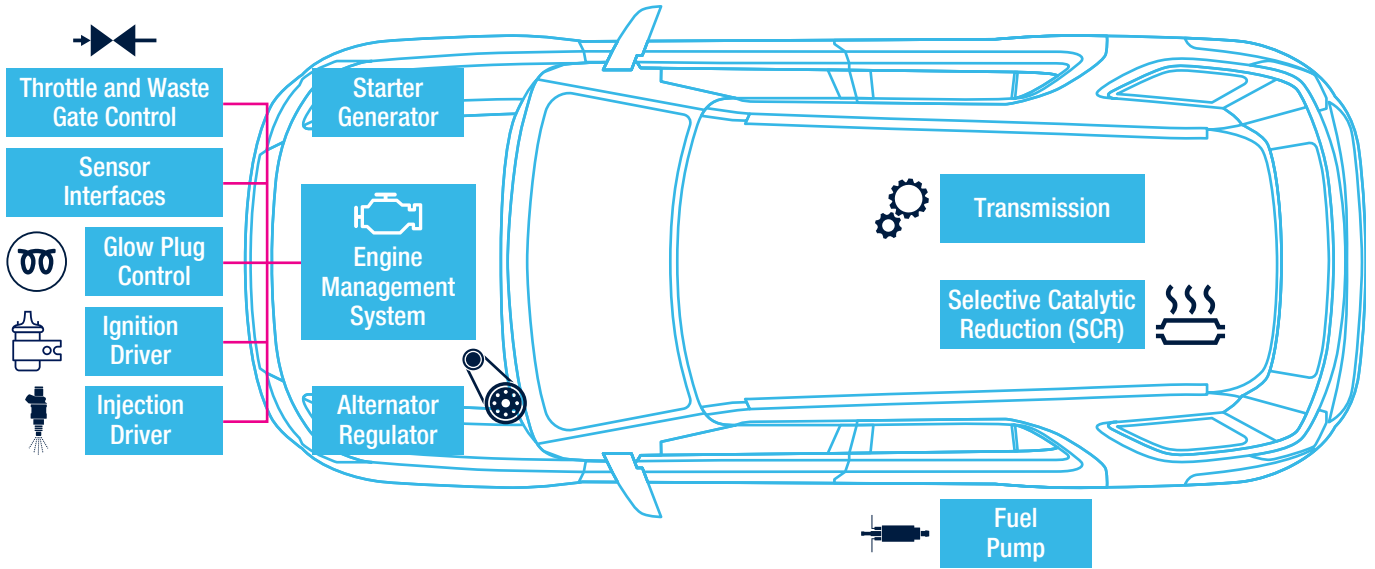

SOLUTIONS

ST's key products and solutions for Powertrain for ICE applications include:

VIPower and BCD Actuators and Motor Control	Transceivers	Power Management	EOS & ESD protection, EMI filters	32-bit Automotive Microcontrollers
	Power Diode, MOSFET & IGBT	Signal Conditioning	Sensor Interfaces	

HW & SW development and evaluation tools



FIND OUT MORE
www.st.com/powertrain-for-ice

Gasoline Direct Injection
 Gasoline multi-point Injection
 Diesel Direct Injection
 LPG Engine Control

CNG Engine Control
 Alternator Regulator
 Fuel Pump
 Motorcycle Engine Control

Selective Catalytic Reduction
 Transmission Control
 Glow Plug Control

In-Vehicle Infotainment



ST

provides IC solutions for complex infotainment cluster, integrating advanced audio and video features

Consumer experiences with personal electronics are shaping expectations for in-vehicle infotainment systems making it a fast-evolving segment of the automotive industry. Vehicle occupants expect to be entertained, connected and able to seamlessly access information and content from a variety of sources.

At ST, we have been developing innovative integrated circuits for in-vehicle Infotainment since our first car radio ICs. Our latest designs provide IC solutions for complex infotainment cluster, integrating state-of-the-art technologies that provide outstanding audio and video features, mirroring smartphones and multimedia devices and running apps, while transmitting data quickly and securely inside and outside the car. Greater processing power, high in-car bandwidth and secure external communication links together with multi-standard radio receivers and world-class audio amplifiers all combine to ensure that you can build infotainment systems for all your markets.

Our extensive infotainment portfolio covers the full application spectrum from high-end integrated platforms (featuring multi-channel digital radio and outstanding full-digital audio amplifiers) to simple, cost-effective entry-level car-radio solutions.

KEY APPLICATIONS

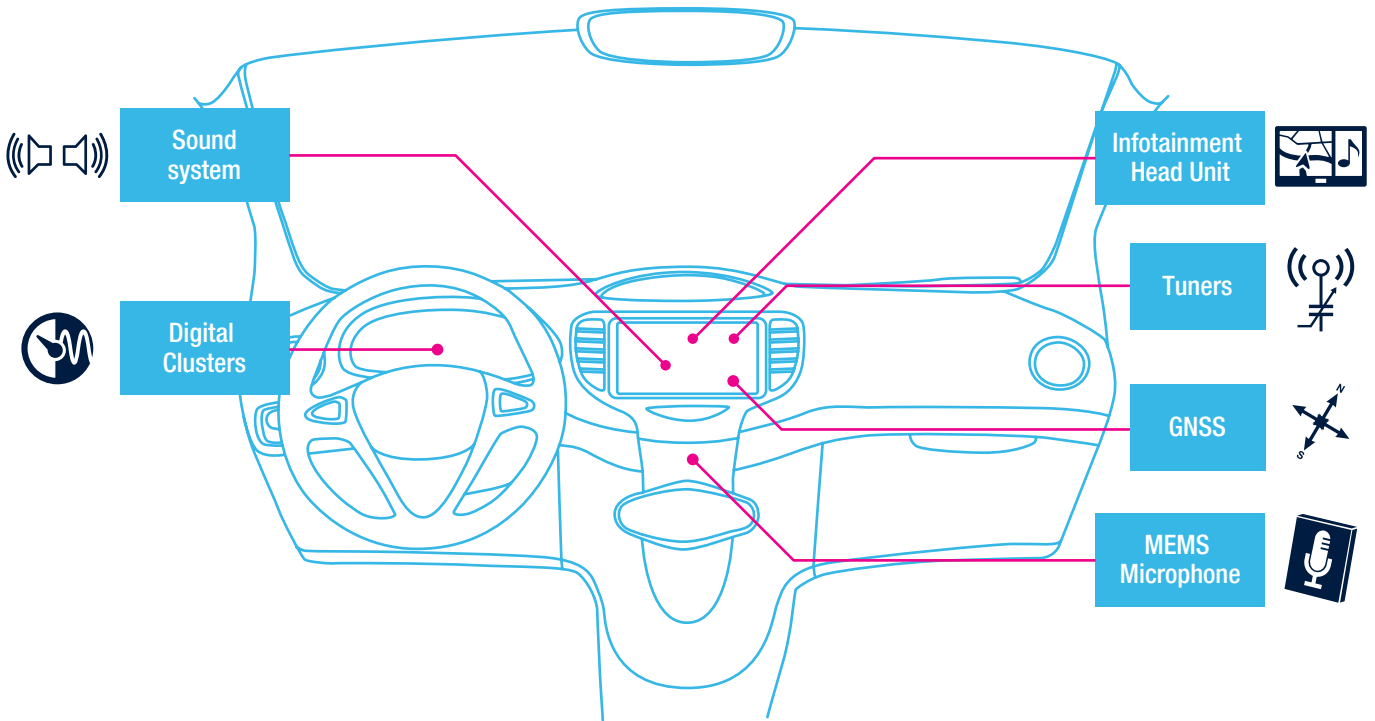

SOLUTIONS

ST's key products and solutions for In-Vehicle Infotainment applications include:

Audio Power Amplifiers	GNSS	Power Management	EOS & ESD protection, EMI filters	Infotainment & Digital Audio Processors and Secure Processors
Tuners	Bluetooth, USB and Connectivity	Sensors	MEMS Microphones	

HW & SW development and evaluation tools



FIND OUT MORE
www.st.com/in-vehicle-infotainment

Infotainment Head Unit Module
 Tuner
 Sound System

Positioning System
 Digital Clusters

Telematics and Networking



ST
covers a wide
selection of
telematics and
networking
devices

Connectivity is revolutionizing the vehicles on our roads. Connectivity to the cloud and cloud-based services benefit occupants but also manufacturers by enabling over-the-air software upgrades and predictive maintenance. The increasing count of electronic control units (ECUs) for safety, engine management, motor control, infotainment all need to be networked, upgradeable and secure. In-car connectivity for occupants, Wi-Fi or Bluetooth needs to fit seamlessly with the other networks. Vehicle-to-Vehicle (V2V) and Vehicle-to-Everything (V2X) communication channels need to be secured and linked with a telematics gateway.

ST's product range covers a wide selection of telematics and networking devices from the most accurate GNSS positioning products to powerful multicore telematics processors with embedded security modules, from sensors for vehicle acceleration/deceleration monitoring and crash detection to smart gateways enabling Firmware-over-the-Air (FOTA) updates.

To provide you with the car connectivity solutions you need, we leverage our extensive hardware and software expertise and our partnerships with market leaders.

KEY APPLICATIONS

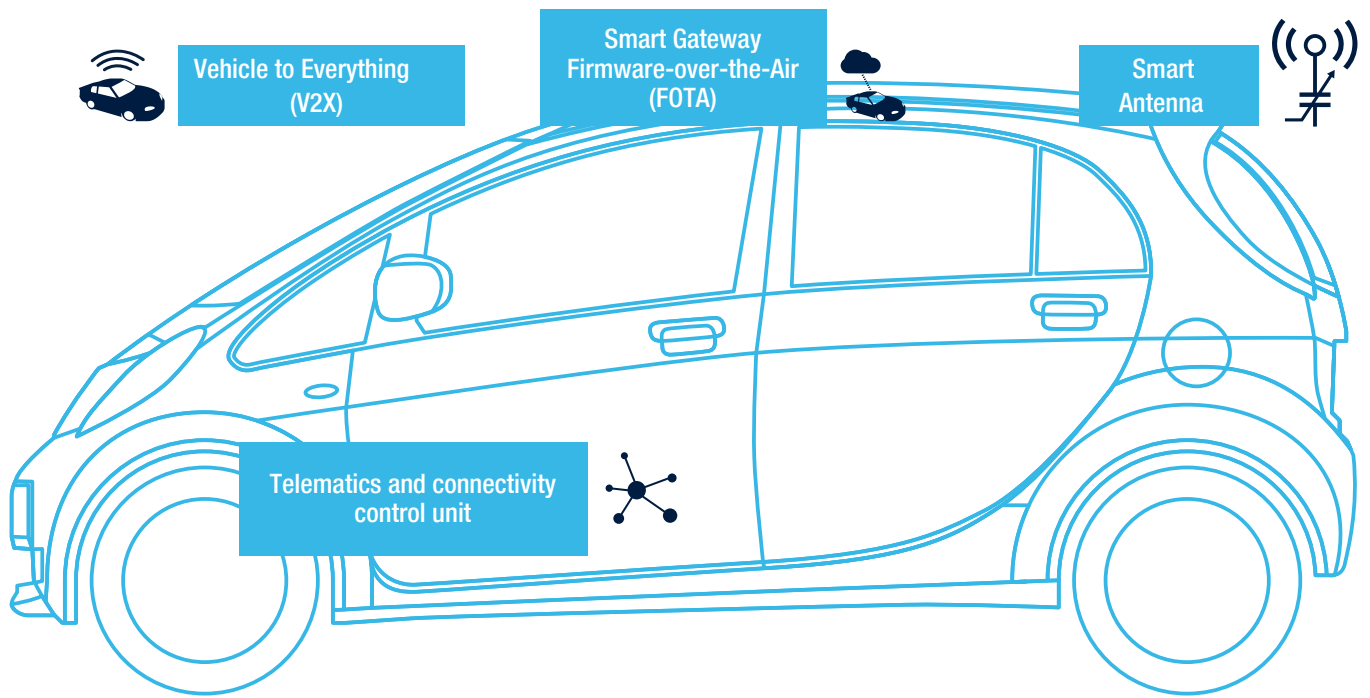

SOLUTIONS

ST's key products and solutions for Telematics and Networking applications include:

GNSS	Bluetooth and Connectivity	Power Management	Telematics & Secure Processors, 32-bit Automotive Microcontrollers
Secure Connectivity	Sensors	EOS and ESD Protection, EMI filters	
HW & SW development and evaluation tools			



FIND OUT MORE
www.st.com/telematics-and-networking

Vehicle-to-Everything (V2X)
 Smart Antenna

Telematics and Connectivity Control Unit
 Smart Gateway Firmware Over-the-Air (FOTA)

Mobility Services



Mobility services are growing rapidly as vehicles become more connected. Powerful processing, vehicle connectivity and innovative sensors enable new possibilities for software service developers and a wealth of applications for car owners.

Services designed to enhance car safety such as “emergency call” in the event of an accident rely on sensors to detect an accident, on telematics processing and GNSS positioning to determine the accident location, and on cameras to record the event and provide advance information to the arriving emergency services.

Insurance boxes can record events prior to accidents but are also changing the market by enabling driver monitoring which provides data to customize tariffs on the driver’s behavior.

Other mobility services range from fleet management, to car sharing, from free parking place detection to road tolling. All these services rely on automotive sensors, processors and communication ICs available from ST.

As the car evolves from a personal vehicle to a shared service provided by a fleet of driverless vehicles in a smart city environment, the level of offered services will grow dramatically. ST’s solutions are used in many advanced driving systems, and our proven record in secure connectivity and sensor technologies can serve as the platform on which Mobility services can be built.

KEY APPLICATIONS

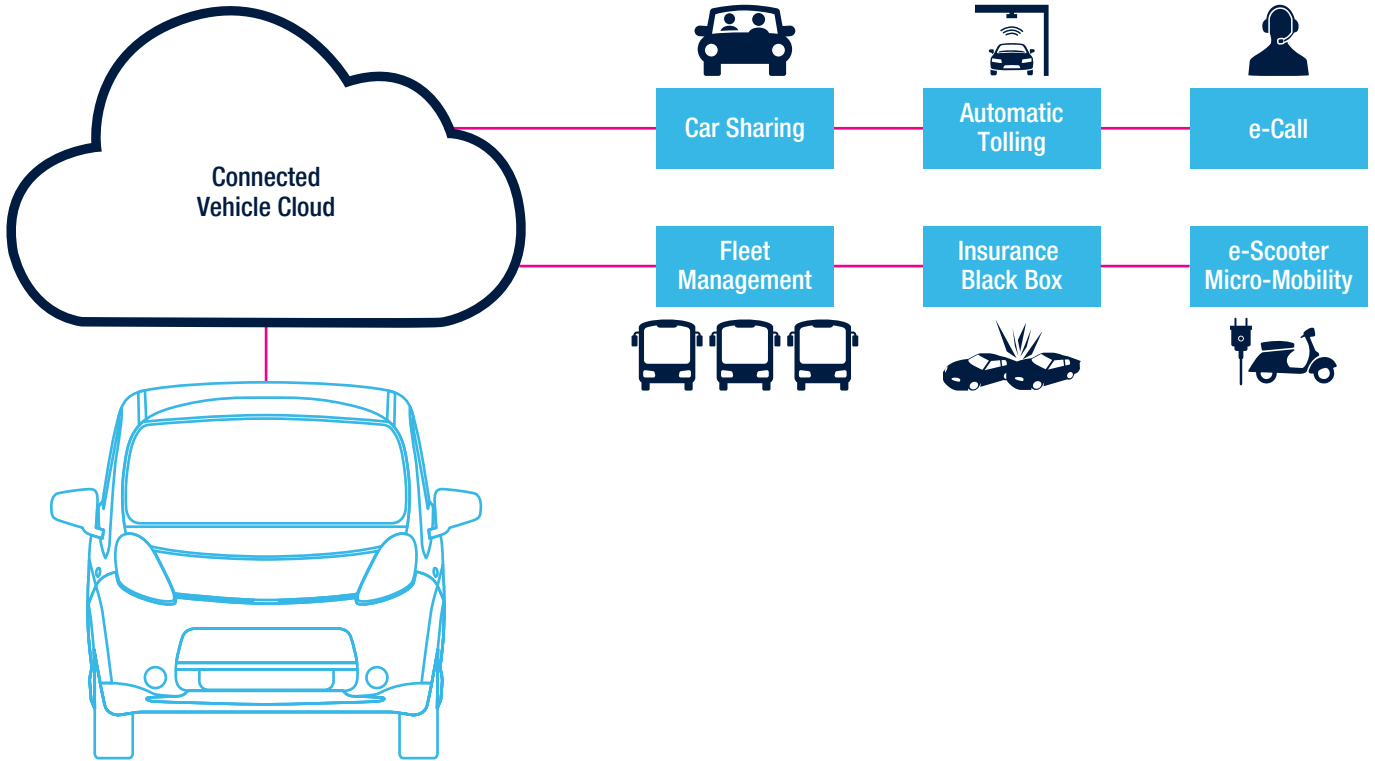

SOLUTIONS

ST's key products and solutions for Mobility Services applications include:

GNSS	Bluetooth, NFC and Connectivity	Ultrafast and Schottky Diodes	Transceivers and Interfaces	Telematics Processors and 32-bit Automotive Microcontrollers
Audio Power Amplifier	Power Management	EOS & ESD protection, EMI filters	Sensors	
HW & SW development and evaluation tools				



FIND OUT MORE
www.st.com/mobility-services

e-Call
 Insurance Black Box
 Fleet Management
 Car Sharing

Automatic Tolling
 Micro-Mobility

Key Technologies

RESEARCH & DEVELOPMENT AND MANUFACTURING

To keep its technology edge, ST maintains a strong commitment to innovation, with approximately 9,000 people working in R&D and product design and spending about 12% of its revenue in R&D. Among the industry's global technology leaders, ST owns and continuously refreshes a substantial patent library with over 19,500 active and pending patents. The company also uses its over 200 R&D partnerships to further foster its innovation.

ST draws on a rich pool of chip-manufacturing technologies, including advanced FD-SOI (Fully Depleted Silicon-on-Insulator) CMOS (Complementary Metal Oxide Semiconductor), differentiated Imaging technologies, RF-SOI (RF Silicon-On-Insulator), BiCMOS, BCD (Bipolar, CMOS, DMOS), Si MOSFET, SiC MOSFET, Si IGBT, VIPower, Transil, Trench Schottky Diodes, and MEMS technologies.

ST believes in the benefits of owning manufacturing facilities and operating them in close proximity to its R&D operations. ST has a worldwide network of front-end (wafer fabrication) and back-end (assembly and test and packaging) plants. ST's principal wafer fabs are located in Agrate Brianza and Catania (Italy), Crolles, Rousset, and Tours (France), and in Singapore. These are complemented by assembly-and-test facilities located in China, Malaysia, Malta, Morocco, the Philippines, and Singapore.

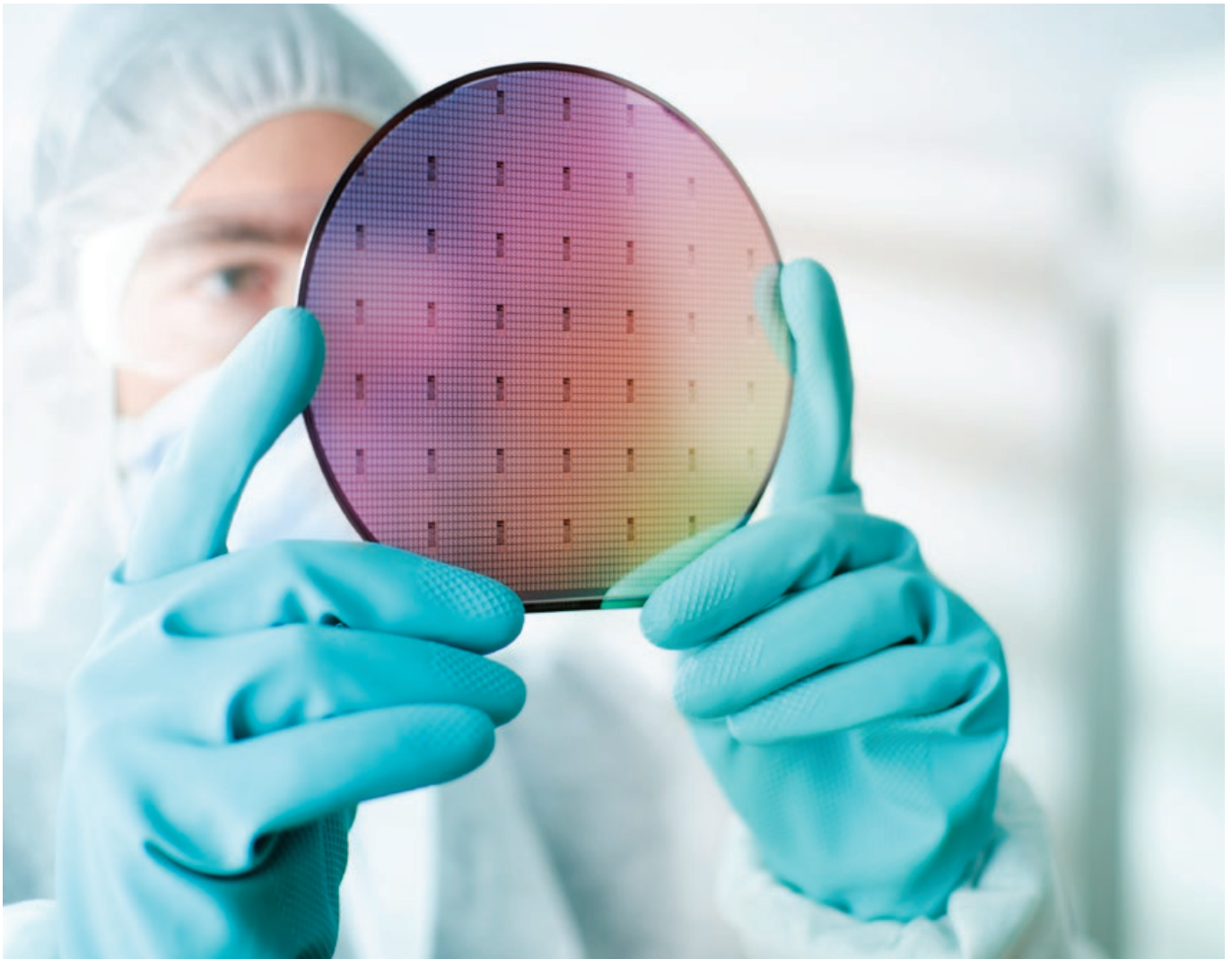

KEY TECHNOLOGIES FOR AUTOMOTIVE PRODUCTS

CMOS (Complementary Metal Oxide Semiconductor)

CMOS (Complementary Metal Oxide Semiconductor) is a pure digital technology invented in the 60's. It is largely used in digital products for processing purposes. Starting from CMOS, other technologies have been set up including BCD (Bipolar-CMOS-DMOS) used for mixed signal products, FD-SOI that allows to reduce silicon geometries below 28nm, and embedded NVM at the heart of MCUs. The robustness and versatility of this technology, present in billions of devices, makes it very suitable for all automotive applications.

FD-SOI / RF-SOI

Fully Depleted Silicon-on-Insulator, or FD-SOI, is a planar process technology that delivers the benefits of reduced silicon geometries while actually simplifying the manufacturing process. The buried oxide layer, specific to FD-SOI MOS, lowers the parasitic capacitances and efficiently confines the electrons flowing from the source to the drain, dramatically reducing performance degrading for leakage currents. This is a key advantage for pure digital products, especially when required to operate at high temperature, allowing very innovative power management techniques. The advanced ADAS platforms are based on this technology and produced in Crolles 300 facility on a 28nm node. Moreover, thanks to the tight electrostatic control of the transistor, FD-SOI is recognized as a leading technology for low-power, RF and millimeter-wave applications.

Associated with the high-density PCM embedded non-volatile memory, ST offers a unique platform for automotive applications.

Key applications include ADAS, RF switches and tuners, low-noise amplifiers, power amplifiers, monolithic integrated RF and FEMs (switches, LNAs, PAs and passives).

FD-SOI

NON-VOLATILE MEMORIES (eNVM)

ST has a strong background in non-volatile memories (NVM) and has developed embedded NVM technologies to enable real-time MCUs and other products that benefit from real-time access to NVM. Today, automotive volumes are at 90 nm and 40 nm technology nodes, and the new Stellar MCU family uses phase-change memory (PCM) to exploit the features of CMOS FD-SOI technology. This evolution to PCM places ST at the forefront of automotive MCUs.

ST standalone non-volatile memories (NVM) are also highly regarded in the industry, especially our automotive serial EEPROM, which is ideal for high-quality and flexible parameter storage, with a wide portfolio ranging from 1 Kbit to 4 Mbits. The automotive Serial EEPROM is robust, high-performance, and designed for intensive operation at high temperatures, making it suitable for all high-reliability applications. The EEPROM is AEC-Q100 qualified, screened through a specific high-reliability testing flow, and PPAP Level 3 compliant. The EEPROM is manufactured in 150 nm technology nodes and is progressively extending to 110 nm. The I²C, SPI, and Microwire buses are supported for three packages: SO8N, TSSOP8, and DFN8 up to 150°C.



BCD (BIPOLAR-CMOS-DMOS)

BCD (BIPOLAR-CMOS-DMOS) is a key technology for power ICs. BCD combines the strengths of three different process technologies onto a single chip: Bipolar for precise analog functions, CMOS (Complementary Metal Oxide Semiconductor) for digital design and DMOS (Double Diffused Metal Oxide Semiconductor) for power and high-voltage elements.

This combination of technologies brings many advantages: improved reliability, reduced electromagnetic interference and smaller chip area.

BCD has been widely adopted and continuously improved to address a broad range of products and applications in the fields of power management, analog data acquisition and power actuators.

VIpower

Vertical Intelligent Power (VIpower) is a technology developed by ST and in production since 1991. VIpower technology provides control, protection and diagnostics for medium/high power automotive loads. The technology combines Vertical Double Diffused MOS Power devices with their own temperature and current sensors and CMOS and HV components for power, analog, and mixed-signal designs.

VIpower technology plays a key role in the move towards electric vehicles. The smart 48 V networks used in mild- and full-hybrid cars require intelligent power switches to drive high- and low-sided loads and electric motors, with very low losses and high current sense accuracy, all monitored via the connections to the ECU microcontroller.

The new VIpower M0-9 SPI drivers feature full digital diagnostics with embedded ADC for load current sensing. These new devices implement sophisticated software logic that also simplifies AUTOSAR compatibility.

Designed to replace standard melting fuses in automotive power distribution systems, our new STi2Fuse smart switches feature wire harness protection on top of the typical high-side driver functions for additional savings on component and production costs, while extending EV range and reducing the carbon footprint of vehicles.



STPOWER

Leading-edge power technologies for both high- and low-voltage applications combined with a full package range and innovative die bonding technologies exemplify ST's innovation in power transistors of the STPOWER family.

ST offers a wide portfolio of power AEC-Q101 qualified Power MOSFETs ranging from -80 to 1200 V, IGBTs with breakdown voltages ranging from 360 to 1200 V and power bipolar transistors ranging from 15 to 1700 V. The improved thermal design of ST's power electronics systems, and our silicon-carbide (SiC) MOSFETs ensure automotive robustness with the industry's highest temperature rating of 200 °C.

Our extensive STPOWER product portfolio combined with state-of-the-art packaging and protection solutions enable designers to create products with high reliability, efficiency and safety.



Silicon Carbide (SiC)

Silicon Carbide (SiC) is a wide bandgap material, with many advantages compared to silicon in the field of power electronics. Operating temperatures are higher, heat dissipation is improved and switching and conduction losses are lower, making it an ideal technology for vehicle electrification. SiC-based traction inverters can increase electric vehicle range and SiC-based chargers reduce the charge time.

ST produces the automotive grade SiC power devices, in Italy and Singapore front-end wafer fabs and is vertically integrating the entire process with the SiC Substrate fab in Italy to be the key enabler in the automotive industry for vehicle electrification.

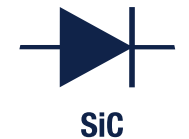

Gallium Nitride (GaN)

The major challenge of power electronics today is to deal with the growing need for power and efficiency improvements and, at the same time, the constant pursuit of cost and size reduction. The introduction of wide bandgap (WBG) materials devices moves in this direction, thanks to their electrical features and considering that Si devices have achieved their theoretical limits with the increased switching frequency. Among the WBG semiconductors, Gallium Nitride (GaN) technology is increasing its importance and diffusion in power conversion applications, becoming at the same time also commercially available. GaN power devices have better figure-of-merit (FOM), $R_{DS(on)}$ than silicon counterparts: in fact, this technology shows low specific $R_{DS(on)}$ and leakage, a high breakdown voltage, zero reverse recovery charge and very low intrinsic capacitances. This leads to better efficiency, higher power density and increased maximum frequency in power converters.

Power modules

Our highly-integrated and high-efficiency ACEPACK power modules, ensures flexible, compact and robust solutions, from few to hundreds of kilowatts, addressing different power converter stages for BEV/HEV, such as main traction inverter, OBC, DC/DC Converters and auxiliaries. Moreover, the very high-power density of the new ACEPACK power modules allows to minimize system space occupation responding to the evolving needs of the market.

The ACEPACK power module family, based on the ST SiC Power MOSFETs, offers wide product portfolio integrating this well-recognized technology. Thanks to their superior features in terms of electrical characteristics and thermal behavior, ACEPACK power modules guarantee a very low $R_{DS(ON)}$ and delivers the best compromise between conduction and switching energies to maximize the efficiency of any converter system.

The power modules offer optimal thermal performance thanks to the active metal brazing or direct copper bonding technologies, ensuring higher thermal conductivity and guarantying a very low thermal resistance as well as a high electrical insulation. Moreover, thanks to the operative junction temperature, up to 175°C, a greater power dissipation can be achieved.

TRANSIL

TRANSIL is a key planar technology for our Automotive transient voltage suppressors (TVS) designed to protect automotive sensitive circuits against surges as defined in ISO 7637-2 and ISO 16750 tests A and B also called load-dump (battery lines), ISO 7637-3 (data lines) and ESD as defined in ISO 10605. Protection is also provided against other perturbations generated by elements like ignition, relay contacts, alternators, injectors, SMPS, etc.

This technology is compatible with high-end circuits where low leakage current and high junction temperatures are required to provide reliability and stability over time.

Data line ESD protection

ST's automotive data line ESD protection devices include transient voltage suppressors (TVS) and application-specific discrete devices that provide system level protection against ESD surges according to standard IEC 61000-4-2. ESD protection devices are manufactured using automotive-grade processes and qualified to AEC-Q101 standards. As such, they can address all automotive applications and domains including advanced driver-assistance systems (ADAS), vehicle-to-everything (V2X), CAN-FD, SerDes (serializer/deserializer), and Ethernet Base-T standards to name just a few, in order to achieve high level immunity with the very low clamping voltage. Moreover, ST offers innovative, miniature wettable flank DFN packages to ease Automatic Optical Inspection (AOI).



A growing and diversified portfolio of MEMS and sensor solutions

Enabling the transition to a sustainable Onlife era, ST offers an extensive MEMS sensor portfolio based on more than 25 years of experience and innovation. Moreover, our new generation of MEMS sensors features an embedded intelligent sensor processing unit (ISPU) to help meet the challenges of incorporating AI into energy-saving Edge-based applications.

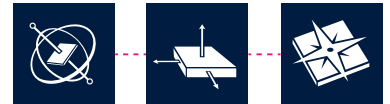

Our sensors offer three key attributes:

- Capable of directly processing the data they capture and delivering meaningful insights in the local device, **smart sensors** reduce transmitted data and cloud processing requirements, thus lowering power consumption at the system level.
- Able to interface with other sensor applications, our **open sensors** let third parties benefit from ST's in-sensor processing innovations, while building an ecosystem to jointly create value for customers.
- Providing high-precision data that allows better quality decisions and makes interactions smoother and more natural, our **accurate sensors** also reduce factory calibration time and resources, which also reduces energy needs.

To reduce design costs and effort for a more rapid time to market, our comprehensive ecosystem includes helpful developer resources with ready-to-use boards as well as software tools and real-life example code.

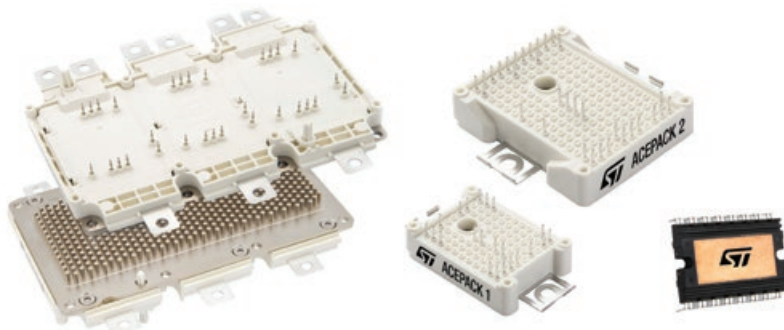

Development Tools

EVALUATION BOARDS, eDESIGN SUITE, AND SOFTWARE TOOLS

ST provides a set of eDesign suites tuned to the needs of the Automotive Industry. Once the appropriate products have been selected, a wide range of samples and evaluation boards are available to help you get started and reduce your development times. In addition to boards, ST provide schematics, BOM and Gerber files to facilitate your hardware design and demonstration software packages are also available.

Evaluation kits

Product evaluation kits help you design, test, and calibrate your automotive application. A wide range of boards is available to evaluate the specific features of products and solutions in their applications. A complete set of documents and resources including circuit diagrams and bills of material as well as reference guides is available. Additional software including ready-to-use example code and user-friendly GUIs complete our offer.

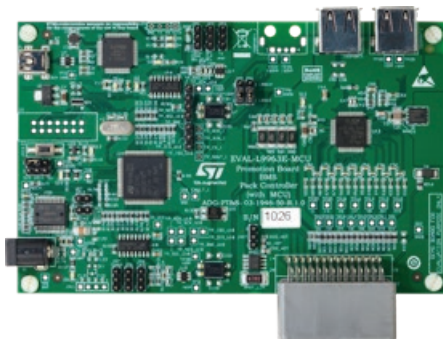
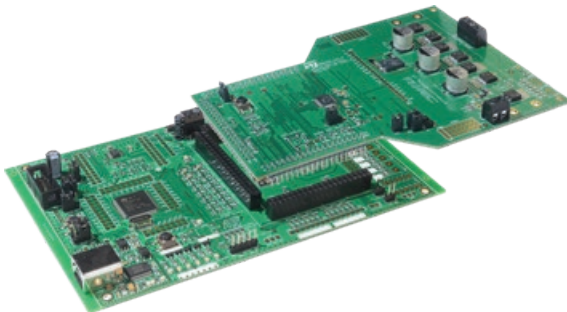

FIND OUT MORE
www.st.com/automotive-evalboards

eDesignSuite

eDesignSuite is a comprehensive set of easy-to-use design-aid utilities ready to help you streamline the system development process with a wide range of ST products.



TwisterSIM

TwisterSIM is an off-line Electro-Thermal simulator for our VIPower automotive power devices. It helps shorten design solution cycle by enabling complex evaluations including load-compatibility, wiring harness optimization, fault condition impact and diagnostic behavior analysis and Dynamic Thermal performance.



STPOWER Studio

The STPOWER Studio dynamic electro-thermal simulation software offers comprehensive power and thermal analysis for a growing number of STPOWER devices. It helps users select the best power device for the specific application mission profile and predicts device behavior under given operating conditions.



Rectifier diode simulator

With just a few clicks our on-line FERD & Schottky diode simulator lets you estimate power losses based on application waveforms and select the best components for your solution.



AC switch simulator

Our AC switch simulator provides graphs of estimated temperature and voltage blocking capabilities to so you can quickly determine the best switch for your solution.



TVS simulator

Simply specify the surge input waveform and system ratings to be protected and this intuitive simulator lets you sort and select the best TVS protection for your design.



FIND OUT MORE
www.st.com/edesign

COMPREHENSIVE SPC5 AUTOMOTIVE MCU DEVELOPMENT ECOSYSTEM

A rich ecosystem with a full set of hardware and software tools allows developers to save time, simplify implementation, quickly prototype their application and benefit from ready-to-use boards and example code. ST offers a wide set of hardware kits ranging from quick evaluation tools to modular and professional boards for developing final proofs-of-concept.

Together with free downloadable SPC5Studio Integrated Development Enviroments (IDE), engineers can easily set up application projects in a short time. SPC5Studio contains a wide selection of example code for starting projects. Additionally, ST offers a set of licensed software packs addressing Safety, Security and AUTOSAR MCAL components.

ST's network of 3rd parties and partners complement the offer with hardware, such as debugger probes, and software tools including compilers and other services.

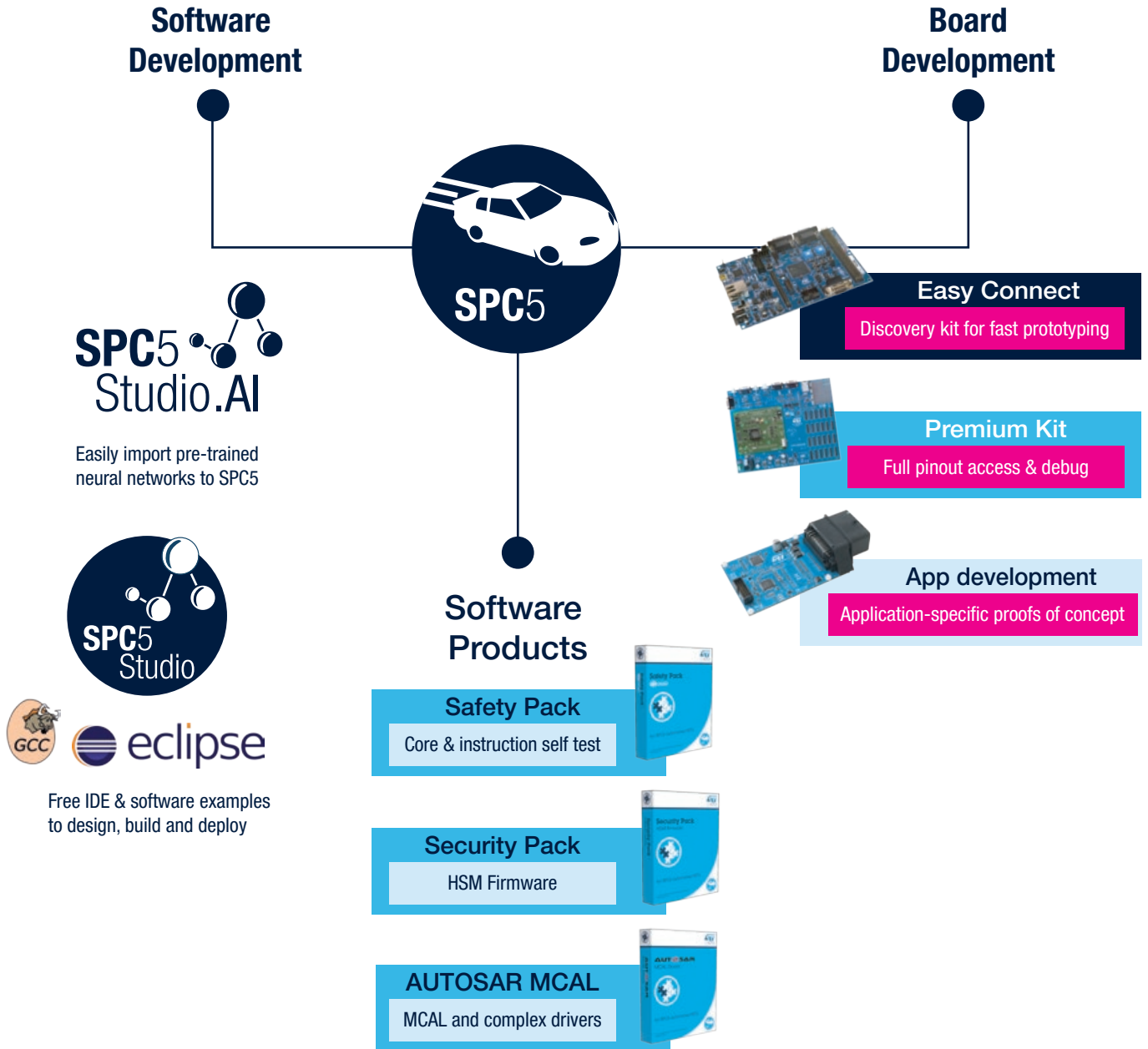

FIND OUT MORE
www.st.com/auto-sp5-mcu-evaltools

STELLARLINK FAST PROTOTYPING FOR AUTOMOTIVE MCUs

StellarLINK is a USB to JTAG passive debugger dongle for Automotive MCUs. It supports SR5, SR6, and SPC5 automotive microcontrollers and their evaluation boards. StellarLINK is Integrated into StellarStudio and SPC5Studio

ST programmer & debugger



Supporting Stellar SR5, SR6, and SPC5 MCUs

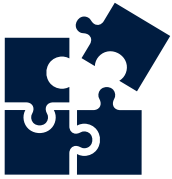

Plug & Play with evaluation boards

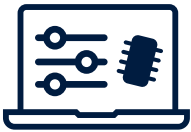

Extending Stellar & SPC5 ecosystem



Eco-friendly packaging

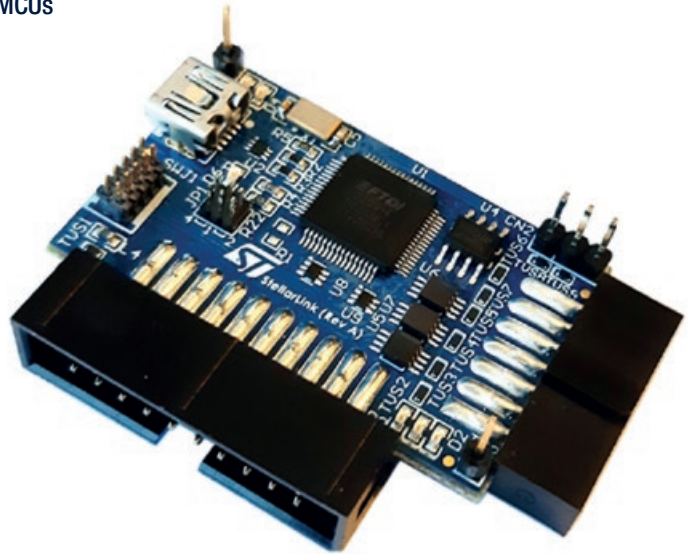

FIND OUT MORE

www.st.com/en/development-tools/stellarlink.html

SPC5 SOFTWARE TOOLS



SPC5Studio is a built-on Eclipse plug-in development environment offering a very intuitive and customizable framework to build and deploy embedded applications for SPC5 Power architecture 32-bit microcontrollers.

Integrating software development tools, device configuration tools and examples, SPC5Studio is a complete solution to speed up project development.

Available free for download on the [st.com](https://www.st.com) website.



SPC5Studio includes **SPC5Studio.AI**, a plug-in for Artificial intelligence-based applications, a seamless way to generate, execute and validate pre-trained NN models on automotive MCUs.

Pre-trained neural networks can be automatically generated into an efficient “ANSI C” library that can be compiled, installed and executed.

Pre-trained neural networks can be easily imported by SPC5Studio.AI from the most widely used deep learning frameworks, such as Keras, TensorFlow Lite, Lasagne, Caffe, ConvNetJS, and ONNX.

SOFTWARE PRODUCTS



SPC5 Security Pack provides basic capabilities to support root-of-trust (RoT) where private encryption keys are kept secret during the microcontroller lifetime using a dedicated location inside the OTP space. To further ensure application security, encryption and decryption functionalities are fully executed on the HSM core.



SPC5 Safety Pack is a comprehensive software package rigorously developed according to an ISO 26262-compliant development process, and helps developers achieve the required safety target, up to the most rigorous ASIL-D level. It includes a Safety kit for the Microcontroller Abstraction Layer (MCAL) as well as Core self-test programs that implement safety counter-measures to ensure compliance with MCU ASIL level requirements.



SPC5 AUTOSAR MCAL Driver offers a full set of Microcontroller Abstraction Layer software components in addition to Complex Device Drivers (CDD) to support specific hardware peripherals. MCAL software components are developed in house, through an ISO 26262-certified development process. ST’s CDD and MCAL drivers are integrated by 3rd party partners with all the components required for the AUTOSAR architecture including basic software layer and OS, offering a complete off-the-shelf AUTOSAR solution.

ST Security Pack, Safety Pack and AUTOSAR MCAL Pack are licensed products.

AutoDevKit AUTOMOTIVE DEVELOPMENT INITIATIVE

AutoDevKit is a fast growing toolset for Automotive & Transportation Application Development. It allows design engineers to quickly build their prototype combining hardware, firmware and software in an easy way and fully supported by our community.

Our ecosystem offers a wide selection of Automotive MCU and devices covering several automotive applications:

- Battery management systems (BMS)
- Logistics and delivery robots
- AI on standard MCUs
- Internal and external lighting
- Power distribution
- Audio generation and AVAS
- Motor control: door control, side mirror, tailgate and seat adjustment
- HVAC, ventilation, and air quality
- USB type-C power delivery



Once the MCU platform and the functions needed for the application are selected, the developer can start from existing demo codes and customize them using high-level programming, without going into deep technical details.

The automatic pin configuration and the visual procedure enable an easy board assembling with the correct wiring and the embedded debug allows to get a working prototype quickly.



FIND OUT MORE
www.st.com/autodevkit

THE AUTODEVKIT ECOSYSTEM INCLUDES:

- MCU Discovery and Functional boards
- System solution and demonstrators
- Embedded software and firmware components and tools

MCU Boards

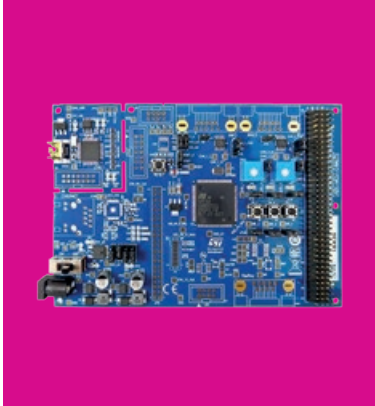

Connector Boards



Functional Boards

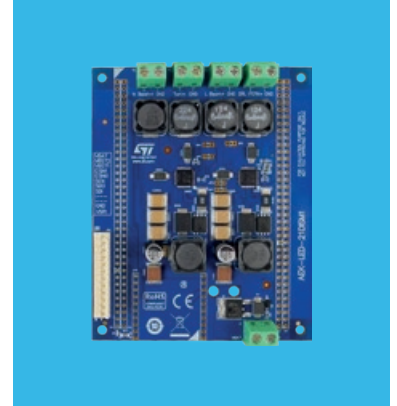

Solution /Demonstrator KIT

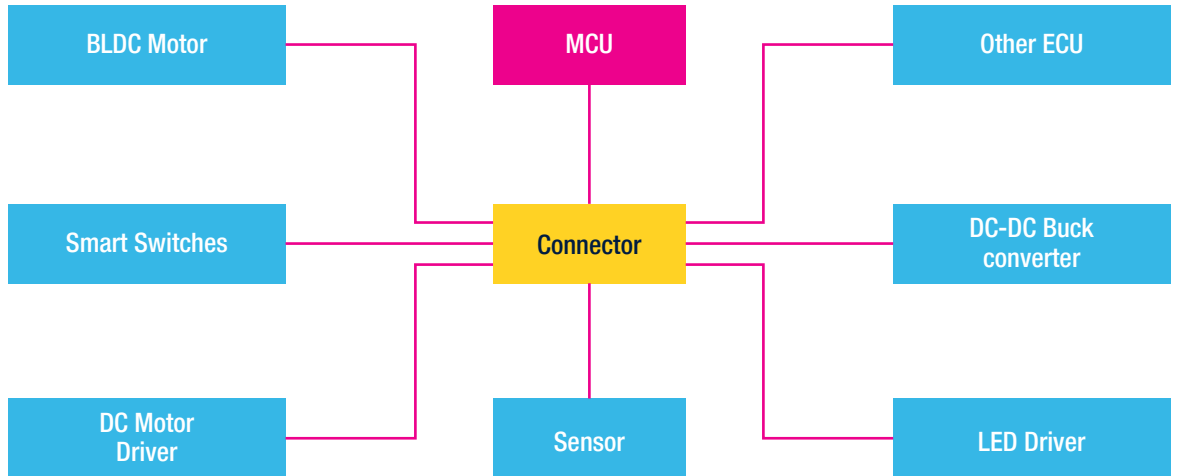

MCU + Connector + Functional boards



Order code: **BR2312AUTOMOTIVE**

For more information on ST products and solutions, visit www.st.com

© STMicroelectronics - November 2023 - Printed in the United Kingdom - All rights reserved
ST and the ST logo are registered and/or unregistered trademarks of STMicroelectronics International NV or its affiliates in the EU and/or elsewhere. In particular, ST and the ST logo are Registered in the US Patent and Trademark Office. For additional information about ST trademarks, please refer to www.st.com/trademarks.
All other product or service names are the property of their respective owners.

