



TSD305

DIGITAL TEMPERATURE SENSORS

Product Description

The TSD Series are digital thermopile sensors in a TO5 package. The TSD sensors include an infrared sensor (thermopile) and a sensor signal conditioner.

The TSD sensors can be interfaced to any microcontroller by an I²C interface. This microcontroller has to calculate the temperature results based on the ADC values and the calibration parameters

Features

- 0°C ... up to +300°C measurement ranges
- Small size
- Small field of view available
- Up to ±1°C accuracy
- I²C Interface
- Low current consumption
- Operating Temperature Range: -10°C ... +85°C

Applications

- Contactless temperature measurement
- Climate control
- Industrial process control
- Household applications

ABSOLUTE MAXIMUM RATINGS

Absolute maximum ratings are limiting values of permitted operation and should never be exceeded under the worst possible conditions either initially or consequently. If exceeded by even the smallest amount, instantaneous catastrophic failure can occur. Even if the device continues to operate satisfactorily, its life may be considerably shortened.

Parameter	Symbol	Condition	Min	Typ	Max	Unit
Supply voltage	V_{DD}	---	-0.3	---	+3.63	V
Storage temperature	T_{stor}	dry	-20	---	+85	°C
Voltage at supply and IO pins	V_{DD} V_{IO}	---	-0.5	---	$V_{DD} + 0.5$	V
Current into supply and IO pins	I_{IN}	---	-100	---	100	mA
ESD rating	ESD	Human Body Model	-2	---	+2	kV
Humidity	Hum	---	Non condensing			---

OPERATING CONDITIONS

If not otherwise noted, 3.3V supply voltage is applied.

Parameter	Symbol	Condition	Min	Typ	Max	Unit
Operating supply voltage	V_{DD}	stabilized, 100nF	1.68	---	3.6	V
VDD rise time	t_{VDD}	---	---	---	200	μs
Operating temperature	T_{op}	---	-20	---	+85	°C
Resolution	RES	---	---	---	0.1	°C
Supply Current	I_{VDD}	Active state, average	---	1050	1500	μA
		Sleep state, idle current	---	20	25	nA
Serial data clock I2C	F_{SCL}	---	10	100	400	kHz
Self-heating	SH	1 sample/s, still air, 60s	---	---	+0.2	°C
VDD capacitor	C_{VDD}	Place close to the sensor	---	100	---	nF

THERMOPILE COMPONENT

If not otherwise noted, 3.3V supply voltage is applied.

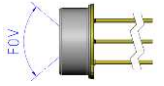
Parameter	Symbol	Condition	Sensor	Min	Typ	Max	Unit
Absorber area	A	---	---	0.8 x 0.8			mm
Field of view	FOV	At 50% of maximum signal 	TSD305-1C55 TSD305-2C55 TSD305-3C55	---	88	---	deg
			TSD305-1SL10	---	10	---	deg
Filter transmission range	---	Long wave pass	TSD305-1C55 TSD305-2C55 TSD305-3C55	>5.5			μm
		Silicon lens, no coating	TSD305-1SL10	≥1.1			μm

TSD305 SERIES

Digital Thermopile Sensor

ANALOGUE TO DIGITAL CONVERTER

Parameter	Symbol	Condition	Min	Typ	Max	Unit
Resolution	ADC _{RES}	---	---	16	---	bit
Conversion time	t _{CONV}	---	---	44.8	59.2	ms
Rise time	t ₆₃	Including rise time of sensor element	---	---	44.8	ms
Resolution internal temperature sensor	ITS _{RES}	---	---	0.003	---	K/LSB

OBJECT TEMPERATURE RANGE

Parameter	Symbol	Sensor	Min	Typ	Max	Unit
Object temperature range ¹⁾	T _{OBJ}	TSD305-1C55 TSD305-3C55	0	---	+100	°C
		TSD305-2C55 TSD305-1SL10	0	---	+300	°C

¹⁾ Other temperatures on request

TOLERANCES

If not otherwise noted, 3.3V supply voltage is applied.

T_{sen} = sensor temperature, T_{obj} = object temperature

Parameter	Symbol	Sensor Temperature	Sensor	Object Temperature	Max	Unit
Accuracy Standard Temp ¹⁾	ACC _S	+15°C < T _{sen} < +35°C	TSD305-1C55 TSD305-3C55	+40°C < T _{obj} < +80°C	±1	%FS
			TSD305-2C55 TSD305-1SL10	+170°C < T _{obj} < +190°		
Accuracy Extended Temp. 1 ²⁾	ACC _{E1}	Complete range	TSD305-1C55 TSD305-3C55	+40°C < T _{obj} < +80°C	±2	%FS
		+15°C < T _{sen} < +35°C		Complete range		
		Complete range	TSD305-2C55 TSD305-1SL10	+170°C < T _{obj} < +190°		
		+15°C < T _{sen} < +35°C		Complete range		
Accuracy Extended Temp. 2 ²⁾	ACC _{E3}	Complete range	TSD305-1C55 TSD305-2C55 TSD305-3C55 TSD305-1SL10	Complete range	±3	%FS

Other temperature ranges and accuracies are available on request.

¹⁾ Ideal, proved by production

²⁾ Ideal case by design

POWER & RESET

Parameter	Symbol	Condition	Min	Typ	Max	Unit
Start-up time	t _{STA1}	V _{DD} ramp up to interface communication	---	---	1	ms
	t _{STA2}	V _{DD} ramp to first ADC measurement	---	---	2.5	ms
Wake up time	t _{WUP1}	Sleep to active state interface communication	---	---	0.5	ms
	t _{WUP2}	Sleep to first ADC measurement	---	---	2	ms
Power down time for reset	t _{RESET}	V _{DD} _{low}	3	---	---	µs
VDD low level	V _{DD} _{low}	---	0	---	0.2	V
VDD rising slope	SR _{VDD}	---	10	---	---	V/ms

TSD305 SERIES

Digital Thermopile Sensor

DIMENSIONS

If not specified, all tolerances according DIN ISO 2768-m.

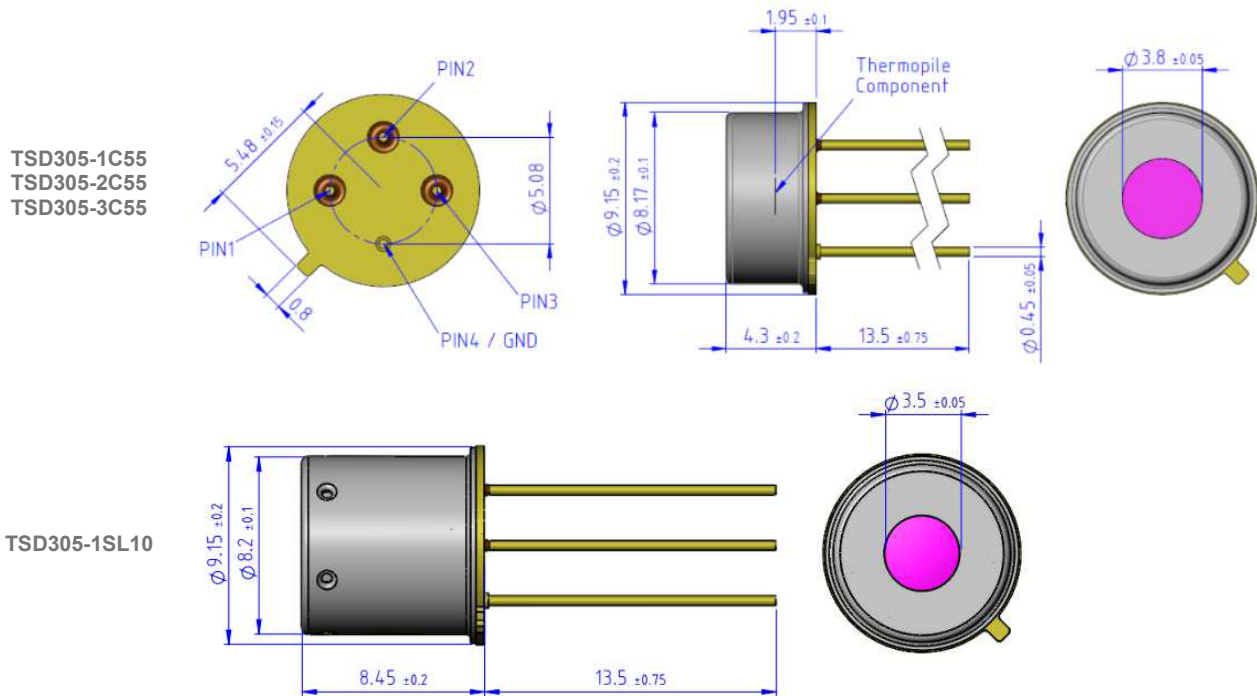

PIN FUNCTION TABLE

Pin	Name	Type	Function
1	SCL	DI	I ² C Clock
2	SDA	DIO	I ² C Data
3	V _{DD}	P	Supply Voltage
4	V _{SS}	P	Ground

I²C INTERFACE

An I²C communication message starts with a start condition and it is ended by a stop condition.

Most commands consist of two bytes: the address byte and command byte.

I²C ADDRESS

The standard I²C address is

Sensor	I ² C Address Hex	I ² C Address Bin
TSD305-1C55 TSD305-2C55 TSD305-1SL10	0x00	0b0000000X
TSD305-3C55	0x1E	0b0011110X

- X = 0: I²C Write
- X = 1: I²C Read

STATUS BYTE

Each return starts with a status byte followed by the requested data word.

Bit	7	6	5	4	3	2	1	0
Meaning	---	---	Busy	---	---	Memory Error	---	---

- Busy: 1 = Sensor is busy. The requested data is not available yet.
- Memory Error: 1 = Memory integrity check failed. Memory was changed after factory calibration.

COMMANDS

Note: Each return starts with a status byte followed by the requested data word. Please take care to wait a certain time after write command before read data.

Command	Return	Description
0x00 ... 0x39	16 bit EEPROM data	Read data from EEPROM address (0x00 ... 0x39) matching the command
0xAF	24 bit object temperature ADC, 24 bit sensor temperature ADC	Measure object temperature and sensor temperature ADC 16 times and calculates mean value. Store data in output buffer.

Read EEPROM

Write Command:

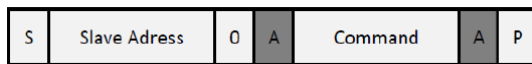

Read EEPROM Data:

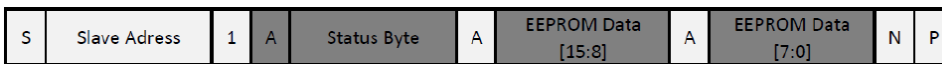

Perform Measurement and Read ADC Data

Write Command:



Read ADC Data:

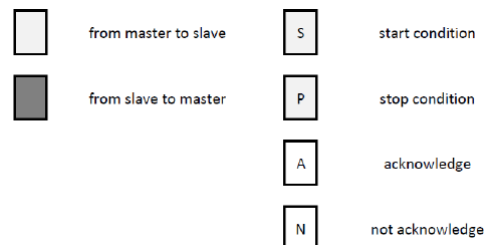

EEPROM CONTENT

Address / hex	Address / dec	Description	Name	Format	Example	
					Content	Value
0x00	0	Lot Nr.	---	UINT16	15001	YY WWW
0x01	1	Serial Number	---	UINT16	12345	Number
0x02	2	I ² C Address Valid range: 0x00 ... 0x7F, 0x04 ... 0x07 are reserved	I ² CAdd	UINT16	0x00	0
0x03 ... 0x19	2 ... 25	Factory Calibration Data	---	---	---	---
0x1A	26	Min. Sensor Temp. / °C	T _{SenMin}	SINT16	0xFFEC	-20°C
0x1B	27	Max. Sensor Temp. / °C	T _{SenMax}	SINT16	0x0055	+85°C
0x1C	28	Min. Object Temp. / °C	T _{ObjMin}	SINT16	0x0000	0°C
0x1D	29	Max. Object Temp. / °C	T _{ObjMax}	SINT16	0x0064	100°C
0x1E	30	Temperature Coefficient	TC	IEEE 754 H-Word	0xBB96	-0.0046
0x1F	31			IEEE 754 L-Word	0xBB99	
0x20	32	Reference Temperature	T _{REF}	IEEE 754 H-Word	0x41D7	26.93
0x21	33			IEEE 754 L-Word	0x70A4	
0x22	34	Compensation Coefficient k4	k _{4comp}	IEEE 754 H-Word	0x3A07	5.161E-04
0x23	35			IEEE 754 L-Word	0x4C8C	
0x24	36	Compensation Coefficient k3	k _{3comp}	IEEE 754 H-Word	0x3F10	5.639E-01
0x25	37			IEEE 754 L-Word	0x5CEC	
0x26	38	Compensation Coefficient k2	k _{2comp}	IEEE 754 H-Word	0x4367	2.311E+02
0x27	39			IEEE 754 L-Word	0x0D1F	
0x28	40	Compensation Coefficient k1	k _{1comp}	IEEE 754 H-Word	0x4724	4.207E+04
0x29	41			IEEE 754 L-Word	0x5A6F	
0x2A	42	Compensation Coefficient k0	k _{0comp}	IEEE 754 H-Word	0xC9A0	-1.312E+06
0x2B	43			IEEE 754 L-Word	0x254D	
0x2C	44	Not used	---	---	---	---
0x2D	45			---	---	
0x2E	46	ADC → T Coefficient k4	k _{4obj}	IEEE 754 H-Word	0x944B	-1.029E-26
0x2F	47			IEEE 754 L-Word	0xD24F	
0x30	48	ADC → T Coefficient k3	k _{3obj}	IEEE 754 H-Word	0x2052	1.787E-19
0x31	49			IEEE 754 L-Word	0xF1C2	
0x32	50	ADC → T Coefficient k2	k _{2obj}	IEEE 754 H-Word	0xABE5	-1.631E-12
0x33	51			IEEE 754 L-Word	0x991B	
0x34	52	ADC → T Coefficient k1	k _{1obj}	IEEE 754 H-Word	0x3797	1.802E-05
0x35	53			IEEE 754 L-Word	0x2BBF	
0x36	54	ADC → T Coefficient k0	k _{0obj}	IEEE 754 H-Word	0x41D7	2.693E+01
0x37	55			IEEE 754 L-Word	0x6DBA	
0x38	56	Factory calibration status – internal usage only	---	UINT16	TBD	---

CHANGE OF I²C ADDRESS

The I²C address of each TSD can be modified to use multiple TSDs on one I²C bus. The used I²C address is configured via an EEPROM address. Power needs to be cycled to active an updated I²C address.

Command	Return	Description
0x00 ... 0x39	16 bit EEPROM data	Read data from EEPROM address (0x00 ... 0x39) matching the command
0x40 ... 0x79	---	Write data from EEPROM address (0x00 ... 0x39).
0x90	---	Calculate and write memory checksum (CRC). If the CRC is valid, then the "Memory Error" status bit is set to 0.

The commands to read and write the EEPROM are shown below. After changing the I²C address, the checksum needs to be recalculated to reset the Memory Error bit.

NUMBER FORMAT

UINT16

- Description: Unsigned integer
- Bits 16
- Min (dec/hec/bin) 0 / 0x0000 / 0b0000 0000 0000 0000
- Max (dec/hec/bin) 65,535 / 0xFFFF / 0b1111 1111 1111 1111

SINT16

- Description: Signed integer
- Bits 16
- Min (dec/hec/bin) - 32,768 / 0x8000 / 0b1000 0000 0000 0000
- Max (dec/hec/bin) 32,767 / 0x7FFF / 0b0111 1111 1111 1111

FLOAT IEEE 754

- Description: Float
- Bits 32
- Min (dec/hec/bin) -1.4E-45 / 0x80000001 / 0b1000 0000 0000 0000 0000 0000 0000 0001
- Max (dec/hec/bin) 3.403E38 / 0x7f800000 / 0b0111 1111 1000 0000 0000 0000 0000 0000
- Example: H-Word 0x3DCC
L-Word 0xCCCD
→ 0b0011 1101 1100 1100 1100 1100 1100 1101
→ 0.1

FLOAT IEEE 754 Conversions

The two integer words can easily be converted to a floating-point number by using a union consisting of an integer array and a float.

```
void main(void)
{
    union
    {
        unsigned int iValue[2];    // 16bit unsigned integer
        float fValue;             // float IEEE 754
    } MyUnion;

    while(1)
    {
        MyUnion.iValue[1] = 0x3dcc;
        MyUnion.iValue[0] = 0xcccd;
        //MyUnion.fValue = 0.1;
    }
}
```

TEMPERATURE CALCULATION

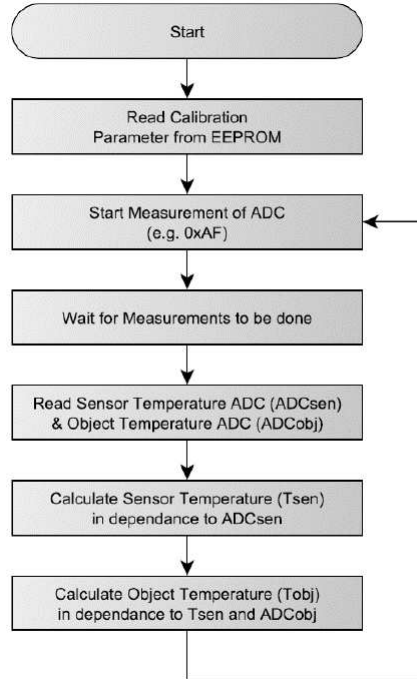

SENSOR TEMPERATURE

The sensor temperature T_{Sen} is calculated from the corresponding 24 bit ADC value ADC_{sen} .

Name	Description	Format	Range	
			Min	Max
ADC_{sen}	ADC Sensor Temperature	INT24	0	16,777,216

ADC_{sen} is scaled to cover the complete sensor temperature range from T_{SenMin} to T_{SenMax} .

Adress / hex	Adress / dec	Description	Name	Format	Example	
					Value	Max
0x1A	26	Min. Sensor Temp. / °C	T_{SenMin}	SINT16	0xFFEC	-20°C
0x1B	27	Max. Sensor Temp. / °C	T_{SenMax}	SINT16	0x0055	+85°C

Formula:

$$T_{sen} = ADC_{sen} / 2^{24} \times (T_{SenMax} - T_{SenMin}) + T_{SenMin}$$

Example:

$$ADC_{sen} = 6,364,157$$

$$T_{sen} = 6,364,157 / 224 \times [+85°C - (-20°C)] + (-20°C) = \underline{19.83°C}$$

OBJECT TEMPERATURE

The object temperature T_{obj} is calculated in dependence of the sensor temperature T_{sen} and ADC_{obj} .

ADC_{obj} is shifted by 2^{23} in order to provide unsigned integer values for positive and negative measurement values.

Name	Description	Format	Range	
			Min	Max
ADC_{obj}	ADC Object Temperature Shifted by 2^{23} (0 is represented by 8,388,608)	INT24	0	16,777,216

The process consists of three successive steps.

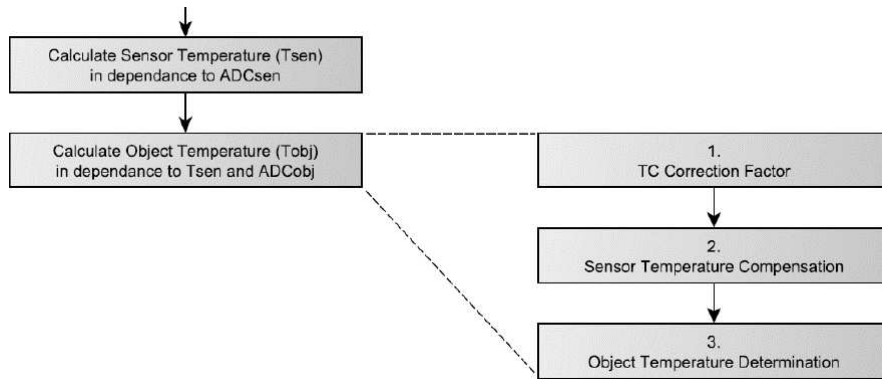

TC Correction Factor

Adress / hex	Adress / dec	Description	Name	Format	Example	
					Content	Value
0x1E	30	Temperature Coefficient	TC	IEEE 754 H-Word	0xBB96	-0.0046
0x1F	31				IEEE 754 L-Word	
0x20	32	Reference Temperature	T_{REF}	IEEE 754 H-Word	0x41D7	+26.93
0x21	33				IEEE 754 L-Word	

Formula:

$$TCF = 1 + [(T_{sen} - T_{ref}) \times TC]$$

Example:

$$T_{sen} = +19.83^{\circ}\text{C}$$

$$T_{ref} = +26.93^{\circ}\text{C}$$

$$TC = -0.0046$$

$$TCF = 1 + [(19.83 - 26.93) \times -0.0046] = \underline{1.0327}$$

Temperature Compensation

Address / hex	Address / dec	Description	Name	Format	Example	
					Content	Value
0x22	34	Compensation Coefficient k4	k4 _{comp}	IEEE 754 H-Word	0x3A07	5.161E-04
0x23	35			IEEE 754 L-Word	0x4C8C	
0x24	36	Compensation Coefficient k3	k3 _{comp}	IEEE 754 H-Word	0x3F10	5.639E-01
0x25	37			IEEE 754 L-Word	0x5CEC	
0x26	38	Compensation Coefficient k2	k2 _{comp}	IEEE 754 H-Word	0x4367	2.311E+02
0x27	39			IEEE 754 L-Word	0x0D1F	
0x28	40	Compensation Coefficient k1	k1 _{comp}	IEEE 754 H-Word	0x4724	4.207E+04
0x29	41			IEEE 754 L-Word	0x5A6F	
0x2A		Compensation Coefficient k0	k0 _{comp}	IEEE 754 H-Word	0xC9A0	-1.312E+06
0x2B				IEEE 754 L-Word	0x254D	

Formula:

$$\text{Offset} = k_{4\text{comp}} \times T_{\text{sen}}^4 + k_{3\text{comp}} \times T_{\text{sen}}^3 + k_{2\text{comp}} \times T_{\text{sen}}^2 + k_{1\text{comp}} \times T_{\text{sen}} + k_{0\text{comp}}$$

$$\text{Offset}_{\text{TC}} = \text{Offset} \times \text{TCF}$$

Example:

$$T_{\text{sen}} = +19.83^{\circ}\text{C}$$

$$k_{4\text{comp}} \dots k_{0\text{comp}} \quad \text{See table above}$$

$$\begin{aligned} \text{Offset} &= 5.161 \cdot 10^{-4} \times 19.83^4 \\ &+ 5.639 \cdot 10^{-1} \times 19.83^3 \\ &+ 2.311 \cdot 10^2 \times 19.83^2 \\ &+ 4.207 \cdot 10^4 \times 19.83 \\ &+ -1.312 \cdot 10^6 \\ &= -382,399 \end{aligned}$$

$$\begin{aligned} \text{Offset}_{\text{TC}} &= -382,399 \times 1.0327 \\ &= -394,904 \end{aligned}$$

Object Temperature Determination

Address / hex	Address / dec	Description	Name	Format	Example	
					Content	Value
0x2E	46	ADC → T Coefficient k4	k4 _{Obj}	IEEE 754 H-Word	0x944B	-1.029E-26
0x2F	47			IEEE 754 L-Word	0xD24F	
0x30	48	ADC → T Coefficient k3	k3 _{Obj}	IEEE 754 H-Word	0x2052	1.787E-19
0x31	49			IEEE 754 L-Word	0xF1C2	
0x32	50	ADC → T Coefficient k2	k2 _{Obj}	IEEE 754 H-Word	0xABE5	-1.631E-12
0x33	51			IEEE 754 L-Word	0x991B	
0x34	52	ADC → T Coefficient k1	k1 _{Obj}	IEEE 754 H-Word	0x3797	1.802E-05
0x35	53			IEEE 754 L-Word	0x2BBF	
0x36	54	ADC → T Coefficient k0	k0 _{Obj}	IEEE 754 H-Word	0x41D7	2.693E+01
0x37	55			IEEE 754 L-Word	0x6DBA	

Formula:

Example:

ADC_{Obj} = 10,738,758
k4_{Obj} ... k0_{Obj} See table above

$$ADC_{Comp} = Offset_{TC} + (ADC_{Obj} - 2^{23})^1$$

$$ADC_{Comp} = -394,904 + 10,738,758 - 8,388,608 = 1,955,246$$

$$ADC_{CompTC} = ADC_{Comp} / TCF$$

$$ADC_{CompTC} = 1,955,246 / 1.0327 = 1,893,334$$

$$T_{Obj} = k4_{Obj} \times ADC_{CompTC}^4 + k3_{Obj} \times ADC_{CompTC}^3 + k2_{Obj} \times ADC_{CompTC}^2 + k1_{Obj} \times ADC_{CompTC} + k0_{Obj}$$

$$T_{Obj} = -1.029 \cdot 10^{-26} \times 1,893,334^4 + 1.787 \cdot 10^{-19} \times 1,893,334^3 + -1.631 \cdot 10^{-12} \times 1,893,334^2 + 1.802 \cdot 10^{-5} \times 1,893,334 + 2.693 \cdot 10 = \underline{56.28^\circ C}$$

¹ Valid if emissivity is 1 (100%). Otherwise the formula in brackets must be replaced by $(ADC_{Obj} - 2^{23}) / \epsilon$. See chapter "Emissivity" on page 13 for details.

Example Code

This example code is meant to illustrate the basic procedure to determinate the measured sensor and object temperatures with respect to TSD digital thermopile sensors. This code needs to be modified with respect to the compiler used.

```

//*****
// File: TSD_Temperature_Determination_Example.c //
// Date: 01.11.2016 //
// Description: This example code is meant to illustrate the basical procedure //
// to determinat the measured sensor and object temperatures with //
// respect to TSD digital thermopile sensors. //
// This code is not meant to work or to be compiled. //
//*****
void TSD_Determine_Temperature(void)
{
    signed int siMinObjTemp, siMaxObjTemp, siMinSenTemp, siMaxSenTemp;
    float fTC, fTref, fK4com, fK3com, fK2com, fK1com, fK0com, fK4obj, fK3obj,
    fK2obj, fK1obj, fK0obj;
    float fTsen, fTobj;
    float fTCF, fOffset, fADCcomp;
    signed long slADC_Object, slADC_Sensor;

    // Read Temperature Range Minimum & Maximum
    siMinSenTemp = (signed int)Read_EE_UInt(26);
    siMaxSenTemp = (signed int)Read_EE_UInt(27);
    siMinObjTemp = (signed int)Read_EE_UInt(28);
    siMaxObjTemp = (signed int)Read_EE_UInt(29);

    // Read all necessary coefficients from the memory, float tye
    fTref = Read_EE_Float(32);
    fTC = Read_EE_Float(30);
    fTref = Read_EE_Float(32);
    fK4com = Read_EE_Float(34);
    fK3com = Read_EE_Float(36);
    fK2com = Read_EE_Float(38);
    fK1com = Read_EE_Float(40);
    fK0com = Read_EE_Float(42);
    fK4obj = Read_EE_Float(46);
    fK3obj = Read_EE_Float(48);
    fK2obj = Read_EE_Float(50);
    fK1obj = Read_EE_Float(52);
    fK0obj = Read_EE_Float(54);

    // Read ADC Values for Object Temp. & Sensor Temp.
    Read_ADC_Values(&slADC_Object, &slADC_Sensor);

    // Calculate Sensor Temp. (slADC_Sensor, Minimum & Maximum Sensor Temp.), Page 8
    fTsen = (float)slADC_Sensor / 16777216.0 * (siMaxSenTemp - siMinSenTemp) + siMinSenTemp;
    // Calculate TC Correction Factor (Temp. Coefficient & Reference Temp.), Page 9 fTCF = 1.0
    + ((fTsen - fTref) * fTC);

    // Calculate Offset Value, Page 10
    fOffset = fOffset + fK4com * fTsen * fTsen * fTsen;
    fOffset = fOffset + fK3com * fTsen * fTsen * fTsen;
    fOffset = fOffset + fK2com * fTsen * fTsen;
    fOffset = fOffset + fK1com * fTsen;
    fOffset = fOffset + fK0com;
    fOffset = fOffset * fTCF;

    // Align ADC Value for Object Temperature, Page 11
    slADC_Object = slADC_Object - 8388608;

    // Calculate Object Temperature, Page 11
    fADCcomp = (float)slADC_Object + fOffset;
    fADCcomp = fADCcomp / fTCF;
    fTobj = fTobj + fK4obj * fADCcomp * fADCcomp * fADCcomp * fADCcomp * fADCcomp;
    fTobj = fTobj + fK3obj * fADCcomp * fADCcomp * fADCcomp;
    fTobj = fTobj + fK2obj * fADCcomp * fADCcomp;
    fTobj = fTobj + fK1obj * fADCcomp;
    fTobj = fTobj + fK0obj;
    // Resulting Sensor Temperature = fTsen
    // Resulting Object Temperature = fTobj
}

```

APPLICATION NOTES

FIELD OF VIEW

The thermopile's field of view must be directed to the object surface of interest. The distance to the surface or the surface diameter must be adjusted to ensure that the complete sensors field of view is covered by the object, see example on the left in the picture below.



TSD305-1C55
TSD305-2C55

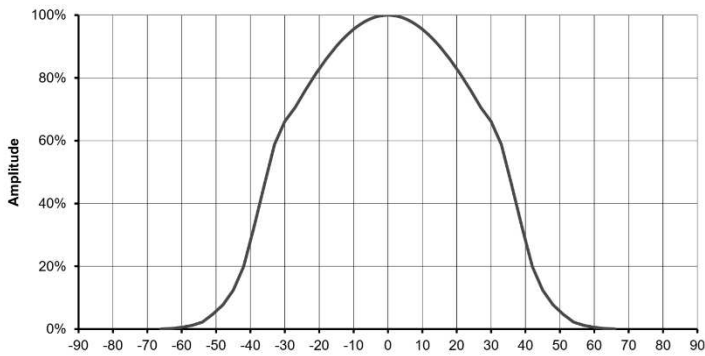

Distance / mm	Min. Diameter / mm
10	24
20	43
30	62
40	82
50	101
100	198
200	391
300	584
400	777
500	970

TSD305-1SL10

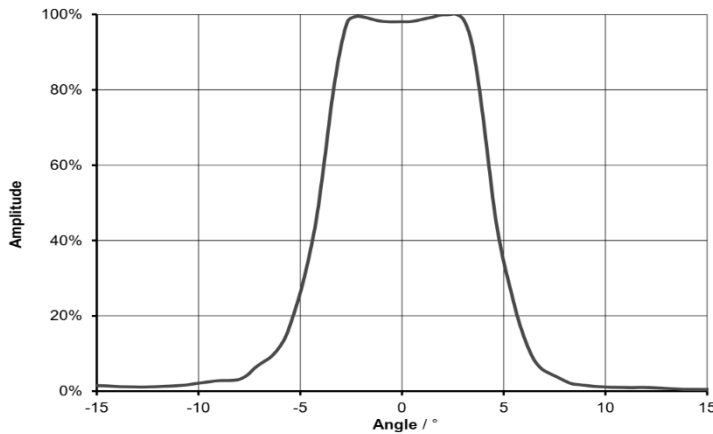

Distance / mm	Min. Diameter / mm
10	6
20	8
30	10
40	11
50	13
100	22
200	39
300	57
400	74
500	92

TSD305 SERIES

Digital Thermopile Sensor

DIRECT SUNLIGHT

Sun light radiation which is transmitted through a glass window may influence the measurement accuracy. To avoid this, the thermopile sensor is equipped with a long wavelength filter. Due to not ideal filter characteristics a small portion of radiation will be added to the radiation of the object. In case of direct sunlight exposure this error can be up to +0.2°C.

TOUCHING THE SENSORS CAP

User should avoid touching the sensors cap. There will still be a measurement deviation after changing the sensors temperature rapidly.

EMISSIVITY

Every object is transmitting infrared energy in dependence to its temperature. The emissivity is the ratio of the radiated power by an object to the radiation of an ideal black body. Common materials like liquids, clothes, human skin, foods have emissivity factors >0.90 and therefore they can be measured very accurately without adopting the sensors specification.

To compensate the measurement for an object with significant low emissivity, ADC_{obj} needs to be adjusted.

Name	Description	Format	Range	
			Min	Max
ADC_{obj}	ADC Object Temperature Shifted by 2^{23} (0 is represented by 8,388,608)	INT24	0	16,777,216
ϵ	Emissivity	100%	0	1

Formula:

$$ADC_{Corr} = (ADC_{Obj} - 2^{23}) / \epsilon$$

Example:

$$ADC_{Obj} = 10,738,758$$

$$\epsilon = 0.9 \text{ (90\%)}$$

$$ADC_{Corr} = 2,611,278$$

Material	Emissivity
Aluminum	
Polished	0.10 – 0.05
Oxidized	0.10 – 0.40
Rough	0.10 – 0.30
Anodized	0.60 – 0.95
Asphalt	0.90 – 1.00
Brass	
Polished	0.05
Oxidized	0.50 - 0.60
Burnished	0.30
Ceramic	0.90 – 0.95
Copper	
Polished	0.10
Oxidized	0.20 – 0.80
Foods	0.85 – 1.00
Gold	0.05
Glass	
Plate	0.90 – 0.95
Fused quartz	0.75

Material	Emissivity
Human Skin	0.99
Iron	
Polished	0.20
Oxidized	0.50 - 0.95
Rusted	0.50 – 0.70
Paint	
Aluminum paint	0.50
Bronze paint	0.80
On metal	0.60 – 0.90
On plastic, wood	0.80 – 0.95
Paper	0.85 – 1.00
Plastic	0.95 – 1.00
Stainless Steel	
Polished	0.10 – 0.15
Oxidized	0.45 - 0.95
Water	
Liquid	0.90 – 0.95
Ice	0.95 – 1.00
Snow	0.80 – 1.00

TSD305 SERIES

Digital Thermopile Sensor

EVALUATION KIT

GENERAL DESCRIPTION

For easy usage and first trials an evaluation kit is available. It consists of an evaluation board and the “DTS-Viewer”-Software. The eval-board provides an USB to I²C interface and can be used on Windows PCs and Android Smartphones with an OTG capable USB port. That means that for example USB flash drives can be connected by an OTG cable to the phone.

The “DTS-Viewer”-Software enables easy measurements and datalogging. This software is available for Windows and Android and supports a wide range of digital temperature sensors provided by TE.

EVALUATION BOARD HARDWARE DESCRIPTION

The following pictures are showing the top and the bottom side of the eval board PCBA.

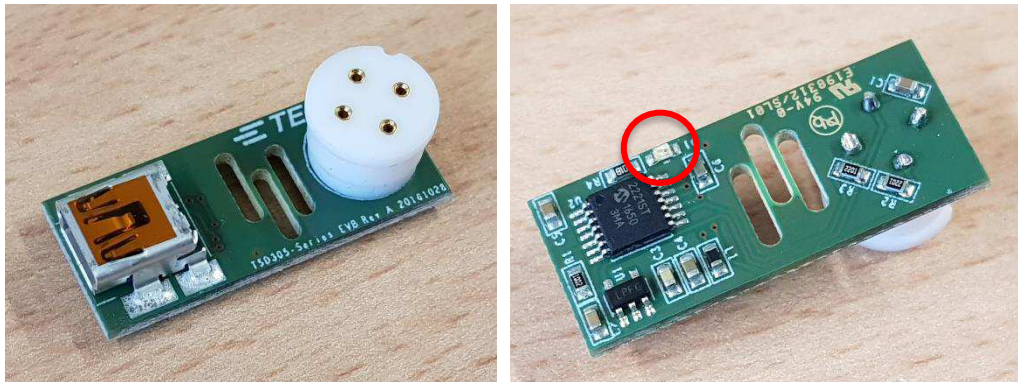

It is equipped with the Microchip™ MPC2221 USB to I²C transceiver, a voltage regulator and some passive components. A status LED (red circle) on the bottom of the PCBA indicates power supply and data transmission.

The TSD must be plugged into the white TO socket; the indicator flag of the TSD has to be matched with notch at the socket. The connection to the PC has to be done by a USB cable with Mini-USB-B-plug on the module's side. For connecting to a smartphone an OTG cable is required. This type of cable is used to connect a slave USB device to the USB connector of the smartphone.

LED Function Table

On state	Function
On	Power on
Flashing	Access / data transmission

DTS-VIEWER DESCRIPTION (PC VERSION)

Overview

The software read out suitable temperature sensors that communicate with an MCP2221 via USB.

The software can display the temperatures measured by the respective sensor and at the same time display the time course of the last 50 measured values in a graph.

In addition, the measured temperatures can be recorded in a text file via the logging function.

During the measurement it is possible to put a filter over the measured values and to vary the measuring speed in given intervals.

To use the software no special installation process is required. Just start the executable file on the USB flash drive that is provided with the evaluation kit.

The following picture shows the main window that appears after starting the executable file.

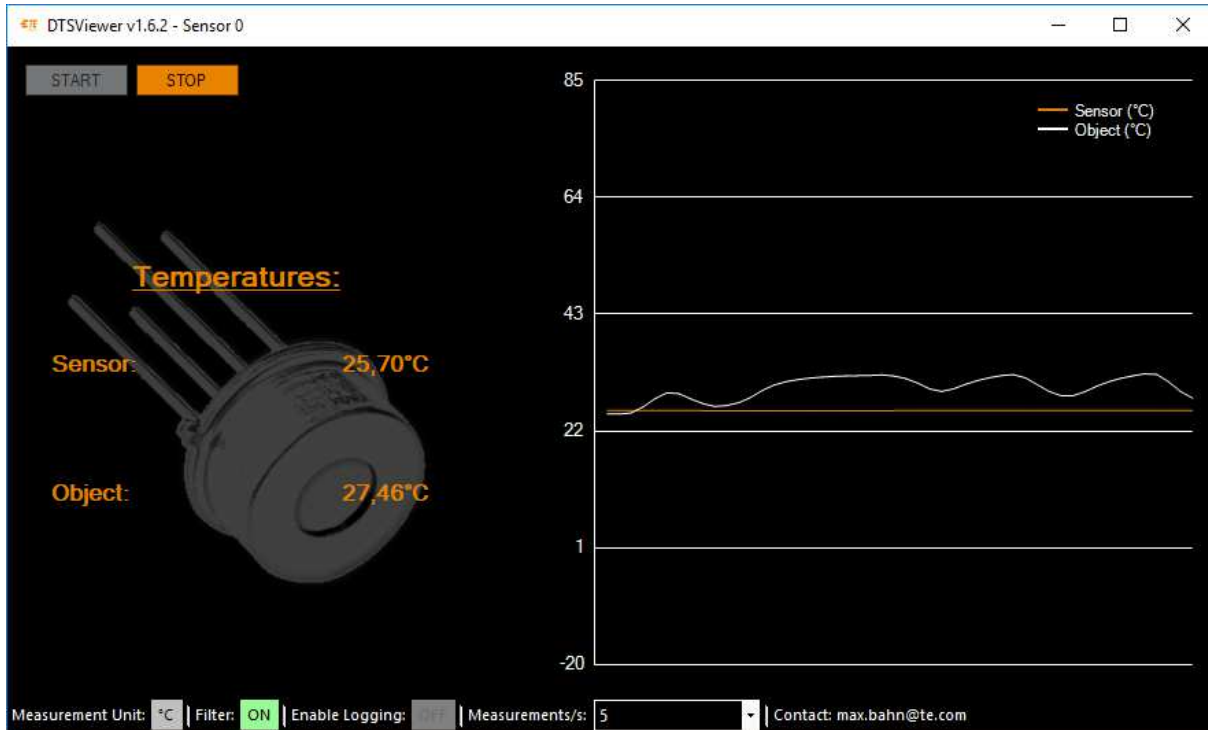

Measurement

First, the evaluation board equipped with a TSD must be connected to the PC.

By pressing the START-button the measurement of both temperatures, sensor package and object temperature is started.

Pressing the STOP-button stops the measurement. Disconnecting the sensor board from the PC has the same effect.

Switching the temperature Unit

The temperature unit can be changed only when the measurement is running. This is done by clicking on the “Measurement Unit”-Symbol on the lower left area. °C and °F can be selected.

Measurement Speed

In the drop-down menu "Measurements/s" the measurement speed can be selected, both before and during a running measurement.

You can select from a predefined selection of measurement speeds. The minimum measurement interval is limited by the internal measurement speed of the sensor.

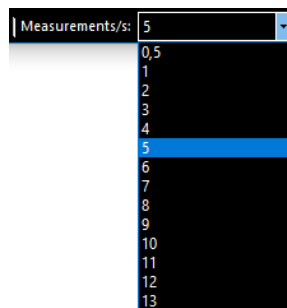

Filter

The "Filter" button enables or disables a filter to smooth the measured values. It can be pressed before or during measurement.

The filter used is a very simple implementation of a moving average filter, which is only intended to provide smoothing for unstable measured values. In this implementation the filter considers the last 5 measured values.

Note: If the measured values must be as accurate as possible or if a fast reaction time is required, the filter should be switched off.

Logging

The software can record the measurement data in a text file. The "Enable Logging" button toggles between recording on and off.

If the logging is set to "ON" the user is prompted to select or create a text file which is then used to save the measurement data each time he starts the measurement.

The text file begins with the time and date information and a description of the format used. Then follows the listing of the measured values, together with sensor type and an individual time stamp.

It should be noted that the measured values are always stored in °C and unfiltered, regardless of what the user has previously set in the program. Only the measuring speed has an influence on the stored data.

Note: The measurement data are stored as tabulator delimited values, so each value is written into a new cell if the measured values are copied into an Excel worksheet.

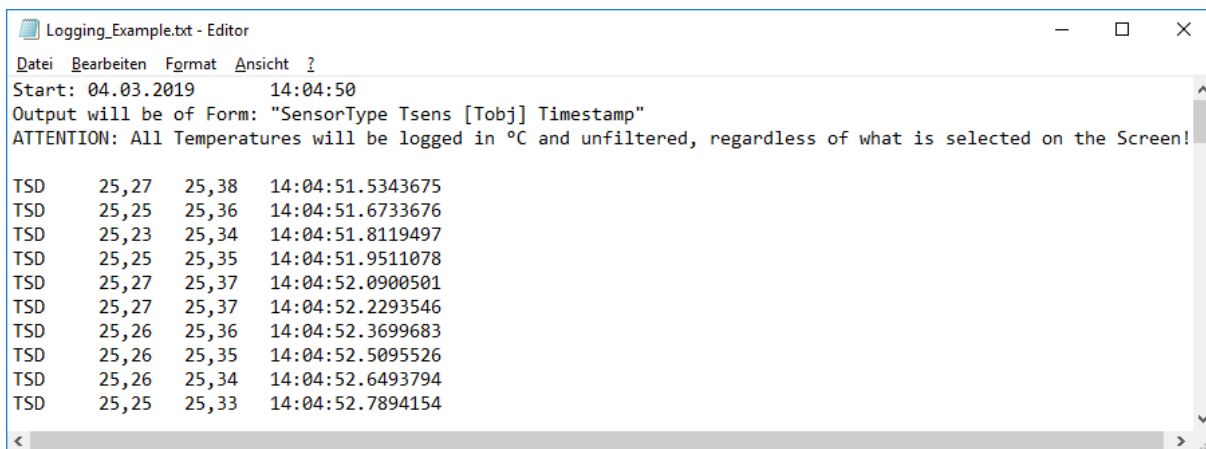

```
Logging_Example.txt - Editor
Datei Bearbeiten Format Ansicht ?
Start: 04.03.2019 14:04:50
Output will be of Form: "SensorType Tsens [Tobj] Timestamp"
ATTENTION: All Temperatures will be logged in °C and unfiltered, regardless of what is selected on the Screen!

TSD 25,27 25,38 14:04:51.5343675
TSD 25,25 25,36 14:04:51.6733676
TSD 25,23 25,34 14:04:51.8119497
TSD 25,25 25,35 14:04:51.9511078
TSD 25,27 25,37 14:04:52.0900501
TSD 25,27 25,37 14:04:52.2293546
TSD 25,26 25,36 14:04:52.3699683
TSD 25,26 25,35 14:04:52.5095526
TSD 25,26 25,34 14:04:52.6493794
TSD 25,25 25,33 14:04:52.7894154
```

Configuring a new Sensorboard – internal usage only

To use this function, the user must right-click on the "START" button and then click on the button that appears.

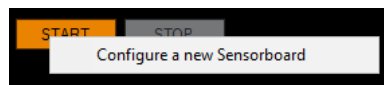

This function is for internal usage only and could lead to malfunction of the evaluation board. If the user activates the function by accident he should leave everything as it is and skip it.

TSD305 SERIES

Digital Thermopile Sensor

ORDER INFORMATION

Further customer specific adaptations are available on request. Please refer to the table below for part name, description and order information.

Part Number	Part Description	Comment
G-TPMO-101	TSD305-1C55 Digital Thermopile Sensor	TO5, I ² C Interface, 0°C ... +100°C
G-TPMO-102	TSD305-2C55 Digital Thermopile Sensor	TO5, I ² C Interface, 0°C ... +300°C
G-TPMO-103	TSD305-3C55 Digital Thermopile Sensor	TO5, I ² C Interface Add=0x1E, 0°C ... +100°C
G-TPMO-104	TSD305-1SL10 Digital Thermopile Sensor	TO5, FOV=10°, I ² C Interface, 0°C ... +300°C
20006766-00	TSD305-Series Evaluation Kit	Contents evaluation board, one piece G-TPMO-101 and 104 and the DTS-Viewer software on USB drive

EMC

Due to the use of these modules for OEM application no CE declaration is done. Especially line coupled disturbances like surge, burst, HF etc. cannot be removed by the module due to the small board area and low-price feature. There is no protection circuit against reverse polarity or over voltage implemented. The module will be designed using capacitors for blocking and ground plane areas in order to prevent wireless coupled disturbances as good as possible.

NORTH AMERICA

Measurement Specialties, Inc.,
a TE Connectivity Company
1711 139th Lane NW
Andover, MN 55304
Tel: +1 763 689 4870
Fax: +1 763 689 5033

customercare.ando@te.com

EUROPE

TE Connectivity Sensors Germany GmbH

Hauert 13

44227 Dortmund
Germany
Tel: +49-231-9740-0
Fax: +49-231-9740-20

CustomerCare.dtmd@te.com

ASIA

Measurement Specialties (China), Ltd.,
a TE Connectivity Company
No. 368 Wulian 1st Road
Gongxing Town
Shuangliu, Chengdu
Sichuan, 610200
China

Tel: +86 (0) 28 8573 9088
Fax: +86 (0) 28 8573 9070

customercare.chdu@te.com

te.com/sensorsolutions

Measurement Specialties, Inc., a TE Connectivity company.

Measurement Specialties, MEAS, TE Connectivity, TE Connectivity (logo) and EVERY CONNECTION COUNTS are trademarks. All other logos, products and/or company names referred to herein might be trademarks of their respective owners.

The information given herein, including drawings, illustrations and schematics which are intended for illustration purposes only, is believed to be reliable. However, TE Connectivity makes no warranties as to its accuracy or completeness and disclaims any liability in connection with its use. TE Connectivity's obligations shall only be as set forth in TE Connectivity's Standard Terms and Conditions of Sale for this product and in no case will TE Connectivity be liable for any incidental, indirect or consequential damages arising out of the sale, resale, use or misuse of the product. Users of TE Connectivity products should make their own evaluation to determine the suitability of each such product for the specific application.

© 2020 TE Connectivity Ltd. family of companies All Rights Reserved.