



Typical Unit

Output Voltage (Vdc)	Output Current (A)	Input Voltage Range (Vdc)
5	24	9-36
12	10	9-36
24	5	9-36

FEATURES

- High efficiency synchronous forward topology.
- 9 – 36 Volts DC wide input range.
- 5/12/24 V, up to 120 W total output power.
- Standard and Flanged baseplate options.
- Industry standard 1/8 brick format & pinout.
- Extensive self-protection features, including over-temperature shutdown.
- Small footprint DC-DC converter, ideal for high current applications.
- Meets AREMA® for 2828Vdc isolation.
- Temperature range -40 to 85°C.
- UL/EN 60950-1 safety approvals.

SAFETY FEATURES

- 2000VAC I/O Isolation, Basic insulation.
- UL 60950-1, 2nd edition.
- CAN/CSA – C22.2 NO.60950-1.
- EN 60950-1.
- RoHS compliant.

PRODUCT OVERVIEW

The IRE-Q12 Series of isolated DC-DC converters feature a single 120W isolated output, from an input voltage range of 9V – 36V DC in a fully enclosed package with industry standard eighth-brick package and footprint. Two base plate options are available, one for minimal board space consumption, the other flanged, slotted for mechanical fixing to a heatsink surface. Positive or Negative Logic On/Off control is also available.

The IRE-Q12 Series is ideal for applications in the Railway/Industrial/Transportation area, designed to accept input from 12V or 24V nominal battery voltages. The IRE output can be trimmed +/-10% while delivering fast settling times to transient step loads and demonstrates no adverse effects from higher capacitive loads. The IRE incorporates all relevant self-protection features including under-voltage lockout, current limit, short circuit protection and over temperature shutdown.

Standard Baseplate Option



Flanged Baseplate Option

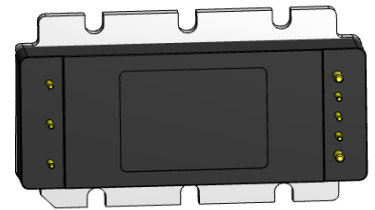

PERFORMANCE SPECIFICATIONS SUMMARY AND ORDERING GUIDE														
Root Model	Output						Input				Efficiency		Package (w/o flange)	
	V _{out} (V)	I _{out} (A, max.)	Power (W)	R/N (mV pk-pk)		Regulation (max.)		V _{in} Nom. (V)	Range (V)	I _{in} , no load (A)	I _{in} , full load (A)	Min.	Typ.	Case (inches)
				Typ.	Max.	Line	Load							
IRE-5/24-Q12	5	24	120	100	150	±0.4%	±0.4%	12	9-36	0.4	10.9	90%	92%	2.41 x 1.01 x 0.5
IRE-12/10-Q12	12	10	120	115	200	±0.3%	±0.3%	12	9-36	0.4	10.9	90%	92%	2.41 x 1.01 x 0.5
IRE-24/5-Q12	24	5	120	150	240	±0.4%	±0.4%	12	9-36	0.08	10.9	90%	92%	2.41 x 1.01 x 0.5

All specifications are at nominal input voltage and full load at room temperature (+25°C) unless otherwise noted. See detailed specifications. Output capacitors are 1µF ceramic multilayer in parallel with 10µF and the minimum requested input capacitor. I/O caps are necessary for our test equipment and may not be needed for your application.

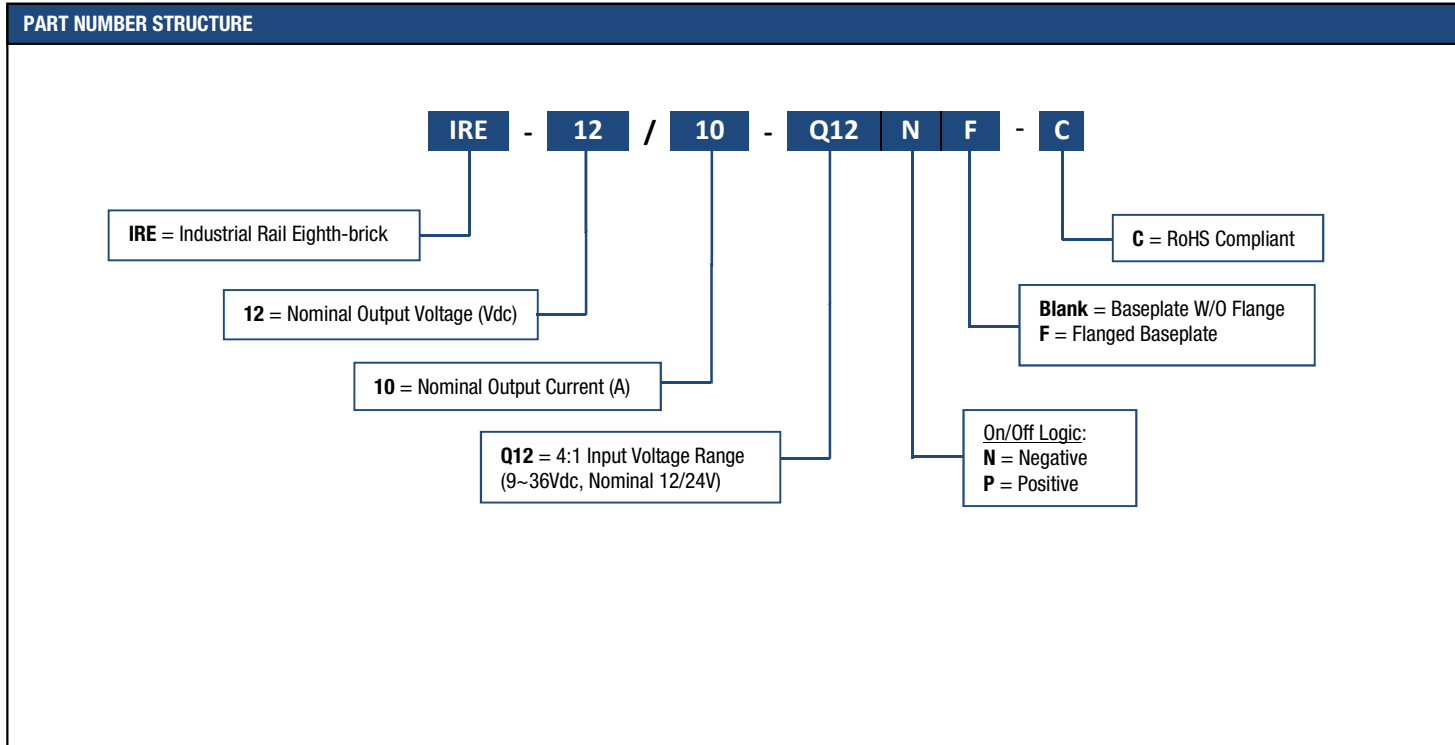

GENERAL SPECIFICATIONS, ALL MODELS

All specifications are at full load with nominal input and output voltage and Ta +25°C unless otherwise noted. Output capacitors are 1µF ceramic multilayer in parallel with 10µF and minimum requested input capacitor. I/O caps are necessary for our test equipment and may not be required for your application. See detailed specifications.

ABSOLUTE MAXIMUM RATINGS	Notes and Conditions	Min.	Typ.	Max.	Units
Input Voltage					
Operating	Continuous	9		36	Vdc
Transient Operating	100ms max., Operating			50	Vdc
Storage Temperature		-55		125	°C
Input to Output Isolation	60 sec. (equivalent to factory test)			2000	VAC
Voltage at ON/OFF control pin		-2		18	Vdc

ISOLATION CHARACTERISTICS	Notes and Conditions	Min.	Typ.	Max.	Units
Isolation Test : Input to Output		2828			Vdc
Input to Baseplate	Actual Factory Test Voltage	1500			Vdc
Output to Baseplate		1500			Vdc
Insulation: Safety Rating			Basic		
I/O Resistance	Input to Output Resistance at 500Vdc	30			MΩ
I/O Capacitance	Input to Output Capacitance		1000		pF

Designed to meet EN50155 Railway standard, the isolation voltage required for Power over Ethernet applications and the American Railway Engineering and Maintenance-of-Way Association (AREMA®) for Communications and Signals.

RELIABILITY/SAFETY/ENVIRONMENTAL			
Safety: Certified to	UL 60950-1/A12:2011, CSA-C22.2 No.60950-1/A1:2011, IEC/EN 60950-1/A12:2011 , 2nd Edition		YES
Calculated MTBF	Belcore, Telcordia SR-332, Issue 3, Method 1, Case 1, Gf	1.7M	Hrs

Note: An external input fuse must always be used to meet these safety requirements.

Mean Time Before Failure (MTBF) is calculated using the Telcordia (Belcore) SR-332 Issue, Case 3, ground benign controlled conditions.

Operating temperature = +40°C, full output load, natural air convection.

MECHANICAL SPECIFICATIONS			
Outline Dimensions – (L x W x H)	Standard Baseplate (Without Flange)	2.41 x 1.01 x 0.50 / 61.2 x 25.7 x 12.7	In./mm
	With Flanged Baseplate	2.41 x 1.45 x 0.50 / 61.2 x 36.8 x 12.7	
Weight		1.84 / 52.16	Oz./g
Baseplate Material		Aluminum	-
Case Material		Plastic	-
Pin Diameter (Power & Signal)	Through Hole	0.062 & 0.040 / 1.57 & 1.02	In./mm
Pin Material	Through Hole	Copper alloy	
Pin Plating Metal and Thickness	Nickel subplate	2.54-7.6	µm
	Gold overplate	0.12-0.50	µm

FEATURES	Notes and Conditions	Min.	Typ.	Max.	Units
ON/OFF Control (P suffix)	Positive Logic				
Off-State Voltage	Pull LOW to Disable Output	0		1.0	V
On-State Voltage	ON/OFF pin HIGH or Open, Output = ON	3.5		15	V
ON/OFF Control (N suffix)	Negative Logic				
Off-State Voltage	ON/OFF pin HIGH or Open, Output = OFF	2.5		15	V
On-State Voltage	Pull LOW to Enable Output	-0.1		0.8	V
ON/OFF Control Current (Either Option)					
Current thru ON/OFF pin	ON/OFF pin Voltage = 0V		1	2	mA
Current thru ON/OFF pin	ON/OFF pin Voltage = 15V			50	μA
Remote Sense Compensation	Connected to respective Vo pin		10		%
Output Voltage Trim Range	Pout<=Max rated power (see Tech. Notes)	-10		10	%
Switching Frequency		220	240	260	kHz

Note: The On/Off pin is normally driven by an open-collector/open-drain drive circuit. External logic may be used if voltage levels are fully compliant to specifications.

TEMPERATURE AND DERATING LIMITS	Notes and Conditions	Min.	Typ.	Max.	Units
Semiconductor Junction Temperature				Tjmax-25	°C
Board Temperature	UL rated max operating temp 130°C			130	°C
Transformer/Inductor Temperature				130	°C
Operating Temperature	Baseplate	-40		115	°C
Over-Temperature Shutdown		115	125	130	°C
Humidity (Operating)		5		95	%
Cooling		Natural/Free Air Convection			-

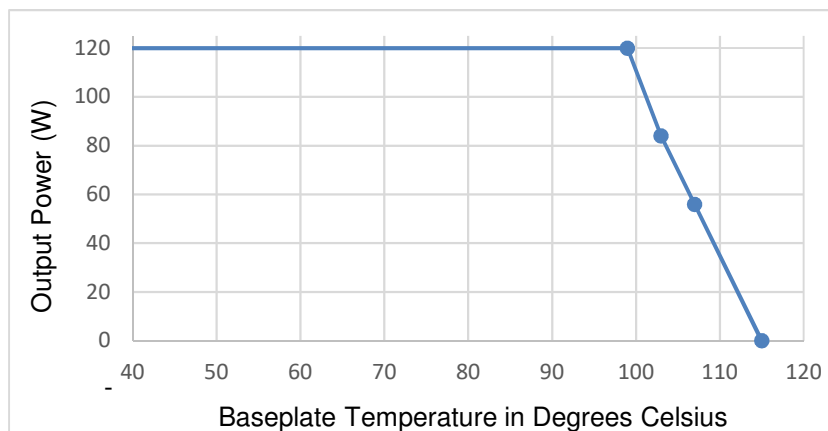

Fig. A-1: Derating Max Baseplate (115°C) Temperature, Vin = 24V (Tested on 10x10 inch PCB)

ELECTROMAGNETIC EMISSIONS		
Conducted Emissions	External filter required, see app. notes	EN55022/CISPR22 CLASS B

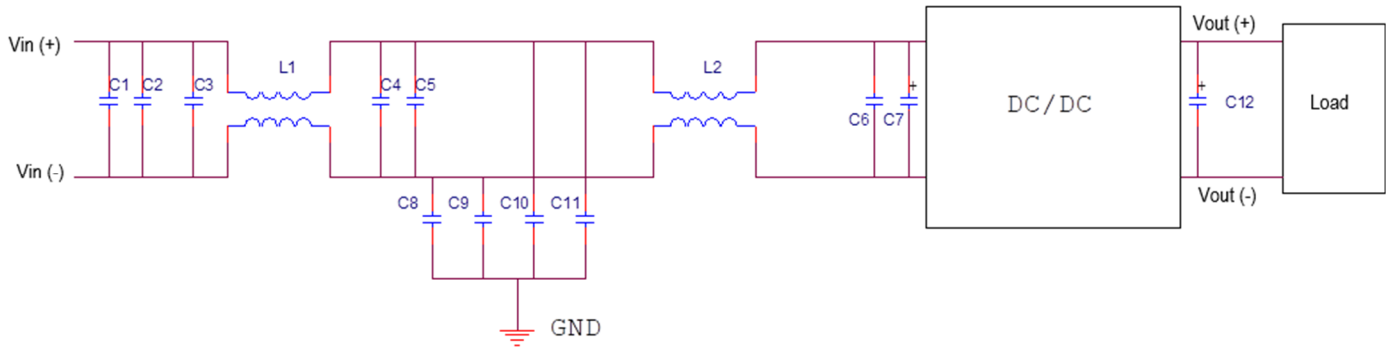

Fig. A-2: EMI Filter for Conducted Emissions Measurement with external components table

Item	Reference	Part Number	Description	Vendor
1	C1, C2, C3, C4, C5	GRM32ER72A105KA01L	SMD CERAMIC-100V-1000nF-X7R-1210	Murata
2	C6	GRM319R72A104KA01D	SMD CERAMIC 100V-100nF-±10%-X7R-1206	Murata
3	L1, L2	P0502NL	COMMON MODE-470uH-±35%-14A	Pulse
4	C8, C9, C10, C11	GRM55DR72J224KW01L	SMD CERAMIC 630V-0.22uF-±10%-X7R-2220	Murata
5	C7	UHE2A221MHD	Aluminum 100V-220uF -±10%-long lead	Nichicon
6	C12	NA		

ENVIRONMENTAL QUALIFICATION TESTING

Parameters	Test conditions	Operating
Vibration	EN 61373:1999 Category I, Class B, Body mounted	Yes
Mechanical Shock	EN 61373:1999 Category I, Class B, Body mounted	Yes
DMTBF (Life Test)	Vin nom , units at derating point,101 days	Yes
Temperature Cycling Test (TCT)	-40 °C to 125 °C, unit temp. ramp 15 °C/min.,500 cycles	Yes
Power and Temperature Cycling Test (PTCT)	Temperature operating = min to max, Vin = min to max, Load = 50% of rated maximum,100 cycles	Yes
Temperature, Humidity and Bias (THB)	85°C, 85RH,Vin=max, Load=min load,1072 Hour (72hours with a pre-conditioning soak, unpowered)	No
Damp heat test, cyclic	EN60068-2-30: Temperatures: + 55 °C and + 25 °C; Number of cycles: 2 (respiration effect);Time: 2 x 24 hours; Relative Humidity: 95%	No
Dry heat test	EN60068-2-2, Vin = nom line, Full load, 85°C for 6 hours.	Yes
High Temperature Operating Bias (HTOB)	Vin = min to max, 95% rated load, units at derating point, 500 hours	Yes
Low Temperature operating	Vin = nom line, Full load,-40°C for 2 hours.	Yes
Highly Accelerated Life Test (HALT)	High temperature limits, low temperature limits, Vibration limits, Combined Environmental Tests.	Yes
EMI	Class A in CISSPR 22 or IEC62236-3-2 (GB/T 24338.4)	Yes
ESD	IEC 6100-4-2: +/-8kv contact discharge +/-15kv air discharge	Yes
Surge Protection	EN50121-3-2	Yes
Solderability	MIL-STD-883, method 2003 (IPC/EIA/JEDEC J-SID-002B)	No

ELECTRICAL INPUT DATA

All specifications are at full load with nominal input and output voltage and Ta +25°C unless otherwise noted. Output capacitors are 1µF ceramic multilayer in parallel with 10µF and minimum requested input capacitor. I/O caps are necessary for our test equipment and may not be required for your application. See detailed specifications.

INPUT CHARACTERISTICS	Notes and Conditions	Min.	Typ.	Max.	Units
Operating Input Voltage Range		9	12	36	Vdc
Input Voltage, Short Term	100ms Transient			50	Vdc
Input Under-Voltage Lockout					
Turn-On Voltage Threshold		8.1	8.8	8.95	Vdc
Turn-Off Voltage Threshold		7.8	8.4	8.8	Vdc
Lockout Voltage Hysteresis			0.4	1.0	Vdc
Input Current Maximum	Vin = 9V, Full Load		14.5	14.96	A
No-Load Input Current	Vin = 12V: 5V/12Vout 24Vout		400 80	600 120	mA
Disabled Input Current	Vin = 12V, Either Logic		15	20	mA
Inrush Current (I²t)			0.1	0.2	A ² S
External Input Fuse	Fast acting external fuse recommended			20	A
External Input Capacitance	Recommended	220	330		µF
Reverse Polarity Protection			External		

If reverse polarity is accidentally applied to the input, to ensure reverse input protection with full output load, always connect an external fast blow input fuse in series with the +Vin input.

5V OUTPUT SPECIFICATIONS, ROOT MODEL IRE-5/24-Q12

All specifications are at full load with nominal input and output voltage and Ta +25°C unless otherwise noted.

OUTPUT CHARACTERISTICS	Notes and Conditions	Min.	Typ.	Max.	Units
Total Output Power	See Derating	0		120	W
Output Voltage Set Point	Vin = Nominal, Io = 0A, Ta = 25°C	4.95	5	5.05	Vdc
Output Over-Voltage Protection	Hiccup mode; auto recovery; over full temp range	6.0	7.0	8.5	Vdc
Output Voltage Regulation					
Over Load	Vin = 12V, Iout from Min to Max		±0.2	±0.4	%
Over Line	Iout = Full load, Vin from Min to Max.		±0.2	±0.4	%
Over Temperature	Vin = 12V, Ta = -40°C to 85°C		0.008	0.02	%/°C
Output Voltage Ripple and Noise	20MHz bandwidth				
Peak-to-Peak	All conditions, 1µF ceramic, 10µF tantalum & 330µF E-Cap		100	150	mVp-p
Output Current Range		0		24	A
Current-Limit Inception	Output Voltage 10% Low	26	30	36	A
Short Circuit Current	Continuous, Hiccup technique with auto recovery		2.0	4.5	A
Output Capacitance	Nominal Vout at full load	330		4700	µF

Do not exceed maximum power ratings if adjusting output trim values.

Output noise may be further reduced by installing an external filter. Larger caps (especially low-ESR ceramic types) may slow transient response and degrade dynamic performance. Thoroughly test your application with all components installed. See Application Notes for additional information.

DYNAMIC CHARACTERISTICS	Notes and Conditions	Min.	Typ.	Max.	Units
Output Voltage During Load Transient	1A/µS, 1µF+10µF load cap				
Step Change in Output Current	50% to 75% to 50% Iout max, 25% to 75% to 25% Iout max		±200 ±350	±300 ±450	mV
Settle Time	To within 1% Vout nom		70	120	µS
Turn-On Transient					
Start-up Time, From ON/OFF Control	To Vout = 90% nominal		30	60	mS
Start-up Time, From Input	To Vout = 90% nominal		30	60	mS
Rise Time	Time from 10% to 90% of nominal output voltage		20	40	mS
Output Voltage Overshoot				2	%

Regulation specifications describe the deviation as the input line voltage or output load current is varied from a nominal midpoint value to either extreme.

External capacitance: 1µF multilayer ceramic in parallel with 10µF electrolytic output and a 220µF/100V input capacitor. All caps described are low ESR.

These capacitors are necessary for our test equipment and may not be needed in your application. All models are stable and regulate within spec without external capacitance.

Testing must be kept short enough that the converter does not appreciably heat up during testing. For extended testing, use plenty of cooling.

EFFICIENCY	Notes and Conditions	Min.	Typ.	Max.	Units
100% Load	Vin = 9V	90	91.5		%
100% Load	Vin = 12V	90	92.0		%
100% Load	Vin = 24V	89	90.5		%

TYPICAL PERFORMANCE DATA, IRE-5/24-Q12

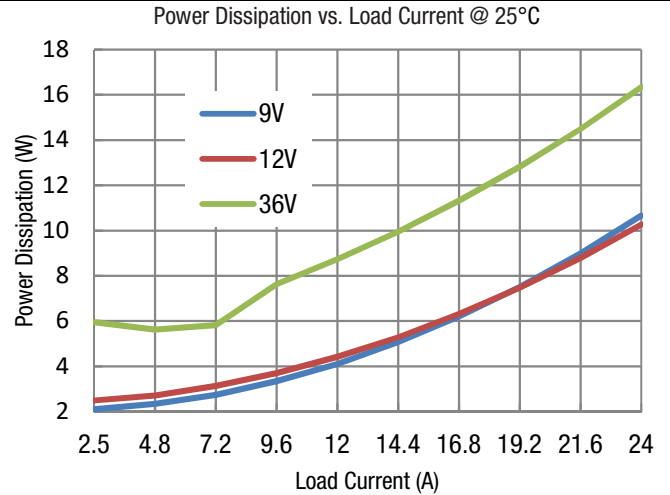
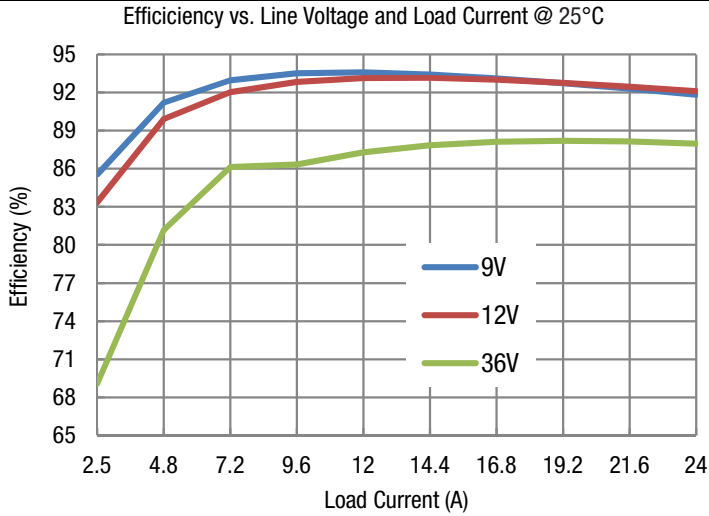

On/Off Enable Delay (Vin = 12V; Vout = nom; Load = 0A; Cloud = 330µF; CH2: Vout; CH4: Enable; Ta = +25°C)

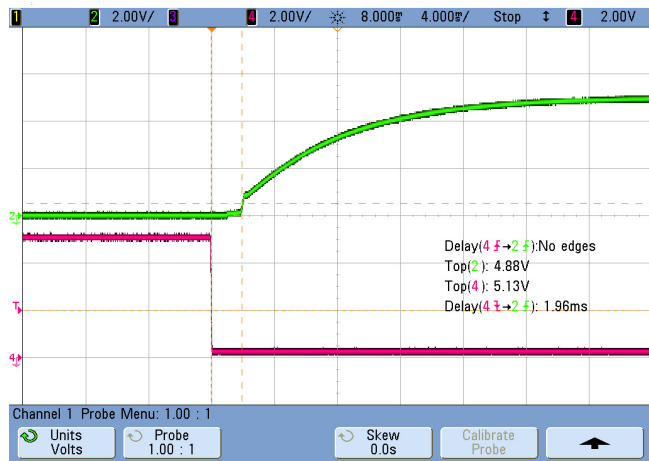

On/Off Enable Delay (Vin = 12V; Vout = nom; Load = 24A; Cloud = 4700µF; CH2: Vout; CH4: Enable; Ta = +25°C)

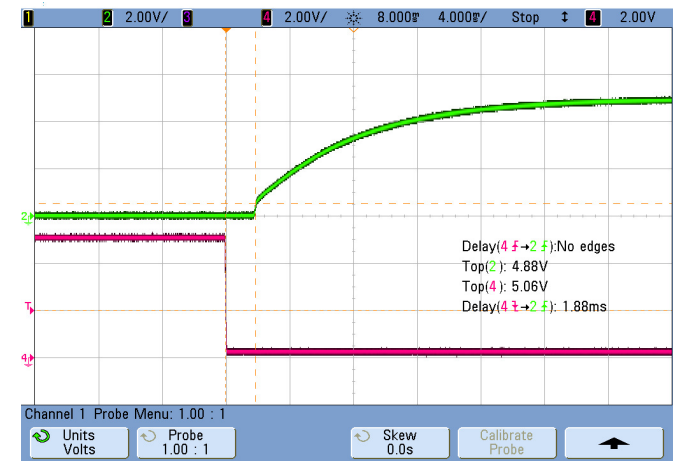

Output Ripple and Noise (Vin = 12V; Iout = 24A; Ta = 25°C; Cloud = 1µF ceramic||10µF tantalum|| 330µF Ecap; Scope BW = 20MHz)

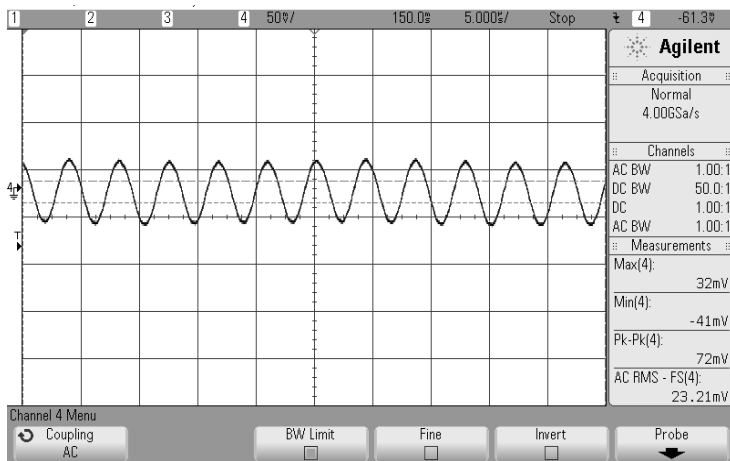

Transient Response (Vin = 12V, Vout = Nom, Iout = 50-75%; Cloud = 1µF ceramic||10µF tantalum|| 330µF Ecap; Slew Rate = 1A/µs, Ta = 25°C)

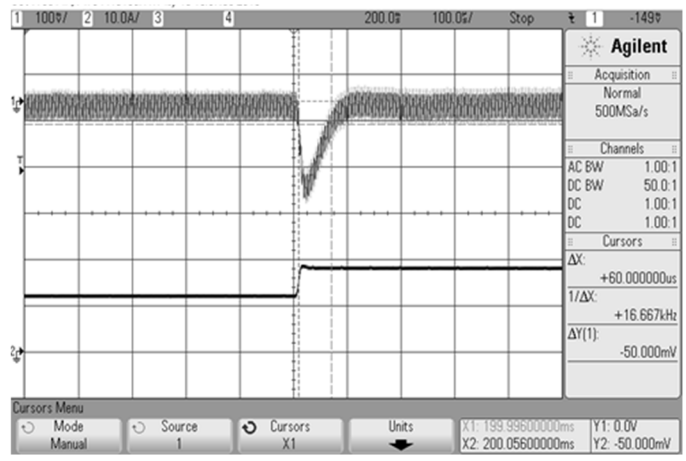

12V OUTPUT SPECIFICATIONS, ROOT MODEL IRE-12/10-Q12

All specifications are at full load with nominal input and output voltage and Ta +25°C unless otherwise noted.

OUTPUT CHARACTERISTICS	Notes and Conditions	Min.	Typ.	Max.	Units
Total Output Power	See Derating	0		120	W
Output Voltage Set Point	Vin = Nominal, Io = 0A, Ta = 25°C	11.88	12	12.12	Vdc
Output Over-Voltage Protection	Hiccup mode; auto recovery; over full temp range	13.8	15.0	16.0	Vdc
Output Voltage Regulation					
Over Load	Vin = 12V, Iout from Min to Max		±0.15	±0.3	%
Over Line	Iout = Full load, Vin from Min to Max.		±0.15	±0.3	%
Over Temperature	Vin = 12V, Ta = -40°C to 85°C		0.008	0.02	%/°C
Output Voltage Ripple and Noise	20MHz bandwidth				
Peak-to-Peak	All conditions, 1µF ceramic, 10µF tantalum & 330µF E-Cap		115	200	mVp-p
Output Current Range		0		10	A
Current-Limit Inception	Output Voltage 10% Low	11	14.5	18.2	A
Short Circuit Current	Continuous, Hiccup technique with auto recovery		1.0	2.3	A
Output Capacitance	Nominal Vout at full load	200		4700	µF

Do not exceed maximum power ratings if adjusting output trim values.

Output noise may be further reduced by installing an external filter. Larger caps (especially low-ESR ceramic types) may slow transient response and degrade dynamic performance. Thoroughly test your application with all components installed. See Application Notes for additional information.

DYNAMIC CHARACTERISTICS	Notes and Conditions	Min.	Typ.	Max.	Units
Output Voltage During Load Transient	1A/µS, 1µF+10µF load cap				
Step Change in Output Current	50% to 75% to 50% Iout max, 25% to 75% to 25% Iout max		±200 ±450	±300 ±600	mV
Settle Time	To within 1% Vout nom		150	200	µS
Turn-On Transient					
Start-up Time, From ON/OFF Control	To Vout = 90% nominal		25	40	mS
Start-up Time, From Input	To Vout = 90% nominal		25	40	mS
Rise Time	Time from 10% to 90% of nominal output voltage		20	60	mS
Output Voltage Overshoot				2	%

Regulation specifications describe the deviation as the input line voltage or output load current is varied from a nominal midpoint value to either extreme.

External capacitance: 1µF multilayer ceramic in parallel with 10µF electrolytic output and a 220µF/100V input capacitor. All caps described are low ESR.

These capacitors are necessary for our test equipment and may not be needed in your application. All models are stable and regulate within spec without external capacitance.

Testing must be kept short enough that the converter does not appreciably heat up during testing. For extended testing, use plenty of cooling.

EFFICIENCY	Notes and Conditions	Min.	Typ.	Max.	Units
100% Load	Vin = 9V	90	92		%
100% Load	Vin = 12V	90	92		%
100% Load	Vin = 24V	88	92		%

TYPICAL PERFORMANCE DATA, IRE-12/10-Q12

Efficiency vs. Line Voltage and Load Current @ 25°C

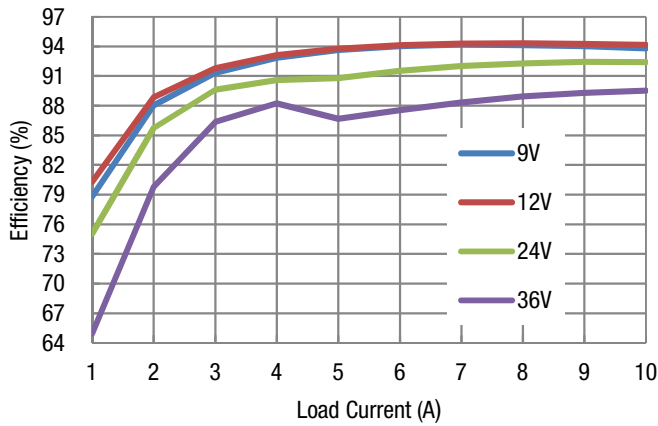

Power Dissipation vs. Load Current @ 25°C

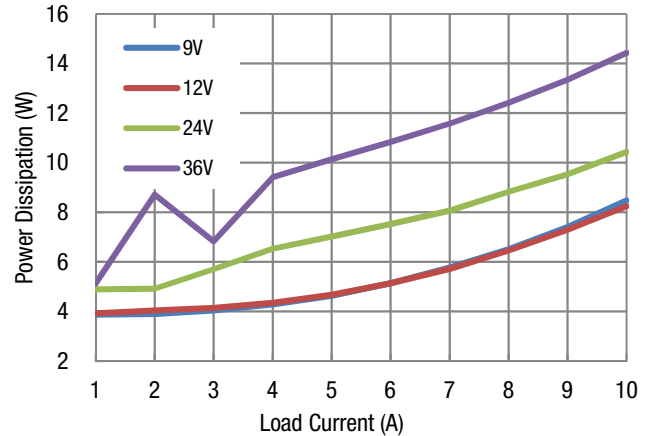

On/Off Enable Delay (Vin = 12V; Vout = nom; Load = 0A; Cloud = 200µF;
CH2: Vout; CH4: Enable; Ta = +25°C)



On/Off Enable Delay (Vin = 12V; Vout = nom; Load = 10A; Cloud = 4700µF;
CH2: Vout; CH4: Enable; Ta = +25°C)



Output Ripple and Noise (Vin = 12V; Iout = 10A; Ta = 25°C; Cloud = 1µF
ceramic||10µF tantalum || 200µF Ecap; Scope BW = 20MHz)

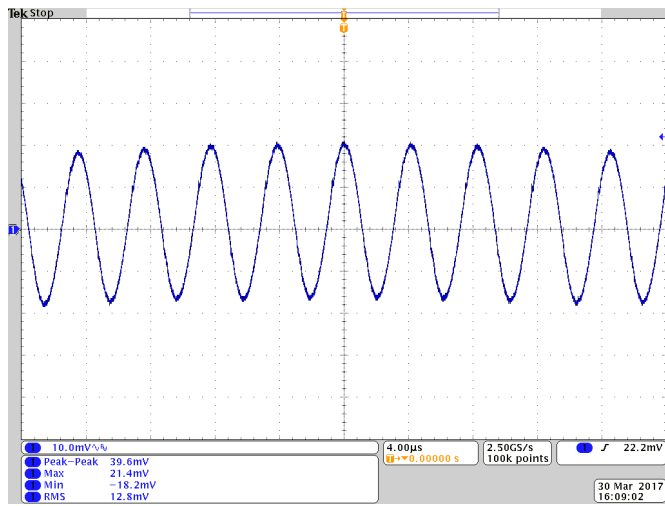

Transient Response (Vin = 12V, Vout = Nom, Iout = 50-75, Cloud = 1µF
ceramic||10µF tantalum|| 200µF Ecap; Slew Rate = 1A/µs, Ta = 25°C)

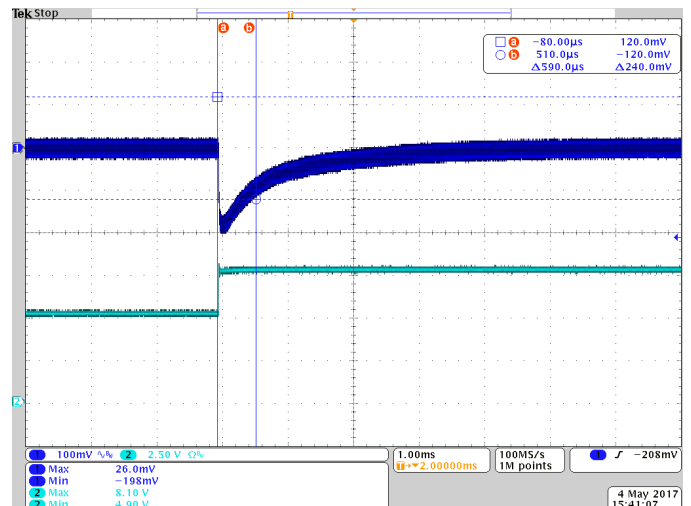

24V OUTPUT SPECIFICATIONS, ROOT MODEL IRE-24/5-Q12

All specifications are at full load with nominal input and output voltage and Ta +25°C unless otherwise noted.

OUTPUT CHARACTERISTICS	Notes and Conditions	Min.	Typ.	Max.	Units
Total Output Power	See Derating	0		120	W
Output Voltage Set Point	Vin = Nominal, Io = 0A, Ta = 25°C	23.76	24	24.24	Vdc
Output Over-Voltage Protection	Hiccup mode; auto recovery; over full temp range	28.0	30.0	35.0	Vdc
Output Voltage Regulation					
Over Load	Vin = 12V, Iout from Min to Max		±0.2	±0.4	%
Over Line	Iout = Full load, Vin from Min to Max.		±0.2	±0.4	%
Over Temperature	Vin = 12V, Ta = -40°C to 85°C		0.008	0.02	%/°C
Output Voltage Ripple and Noise	20MHz bandwidth				
Peak-to-Peak	All conditions, 1µF ceramic, 10µF tantalum & 330µF E-Cap		150	240	mVp-p
Output Current Range		0		5	A
Current-Limit Inception	Output Voltage 10% Low	6.0	7.0	8.5	A
Short Circuit Current	Continuous, Hiccup technique with auto recovery		1.0	2.0	A
Output Capacitance	Nominal Vout at full load	100		1000	µF

Do not exceed maximum power ratings if adjusting output trim values.

Output noise may be further reduced by installing an external filter. Larger caps (especially low-ESR ceramic types) may slow transient response and degrade dynamic performance. Thoroughly test your application with all components installed. See Application Notes for additional information.

DYNAMIC CHARACTERISTICS	Notes and Conditions	Min.	Typ.	Max.	Units
Output Voltage During Load Transient	1A/µS, 1µF+10µF load cap				
Step Change in Output Current	50% to 75% to 50% Iout max, 25% to 75% to 25% Iout max		±250 ±350	±350 ±500	mV
Settle Time	To within 1% Vout nom		200	500	µS
Turn-On Transient					
Start-up Time, From ON/OFF Control	To Vout = 90% nominal		25	40	mS
Start-up Time, From Input	To Vout = 90% nominal		25	40	mS
Rise Time	Time from 10% to 90% of nominal output voltage		25	60	mS
Output Voltage Overshoot				2	%

Regulation specifications describe the deviation as the input line voltage or output load current is varied from a nominal midpoint value to either extreme.

External capacitance: 1µF multilayer ceramic in parallel with 10µF electrolytic output and a 220µF/100V input capacitor. All caps described are low ESR.

These capacitors are necessary for our test equipment and may not be needed in your application. All models are stable and regulate within spec without external capacitance.

Testing must be kept short enough that the converter does not appreciably heat up during testing. For extended testing, use plenty of cooling.

EFFICIENCY	Notes and Conditions	Min.	Typ.	Max.	Units
100% Load	Vin = 9V	90	91.5		%
100% Load	Vin = 12V	90	92.0		%
100% Load	Vin = 24V	88	91.0		%

TYPICAL PERFORMANCE DATA, IRE-24/5-Q12

Efficiency vs. Line Voltage and Load Current @ 25°C

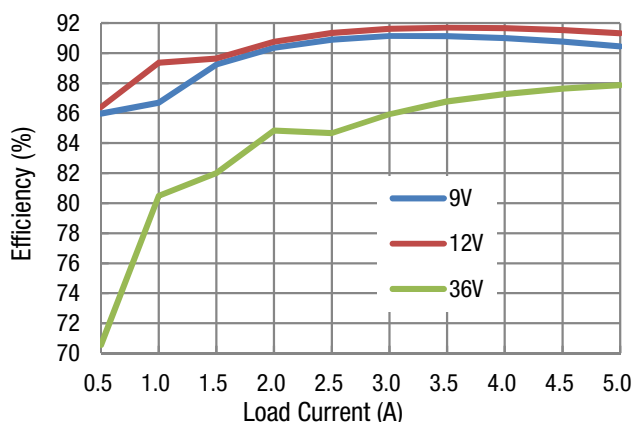

Power Dissipation vs. Load Current @ 25°C



On/Off Enable Delay (Vin = 12V; Vout = nom; Load = 0A; Cloud = 100µF;
CH2: Vout; CH4: Enable; Ta = +25°C)

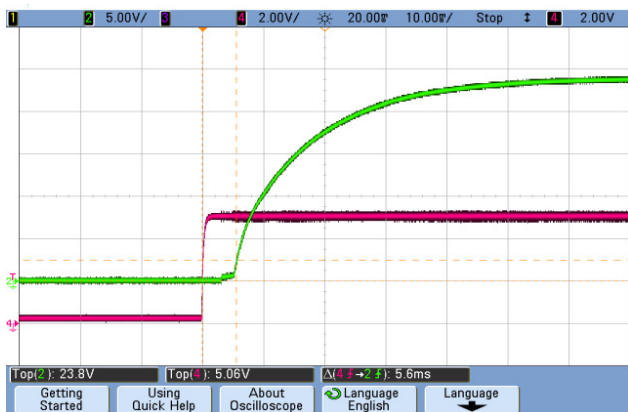

On/Off Enable Delay (Vin = 12V; Vout = nom; Load = 5A; Cloud = 1000µF;
CH2: Vout; CH4: Enable; Ta = +25°C)



Output Ripple and Noise (Vin = 12V; Iout = 5A; Ta = 25°C; Cloud = 1µF ceramic||10µF tantalum|| 100µF Ecap; Scope BW = 20MHz)

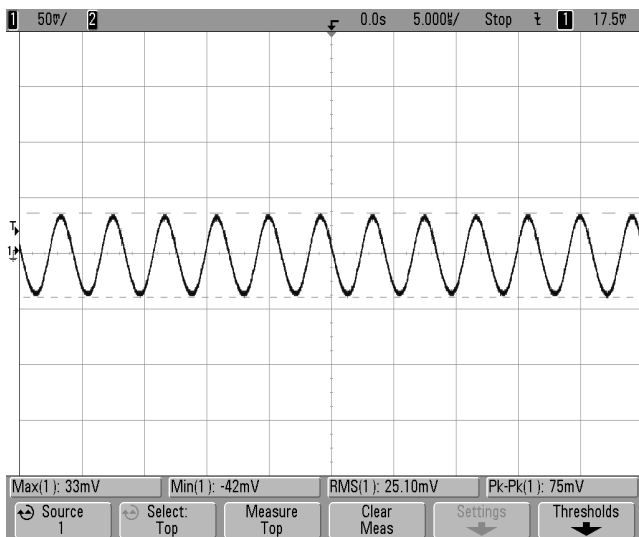

Transient Response (Vin = 12V, Vout = Nom, Iout = 50-75, Cloud = 1µF ceramic||10µF tantalum|| 100µF Ecap; Slew Rate = 1A/µs, Ta = 25°C)

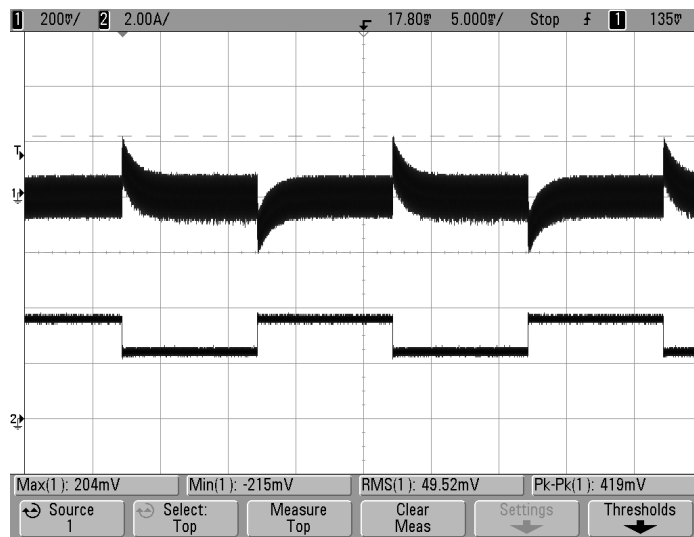

MECHANICAL SPECIFICATIONS

Flanged Baseplate:

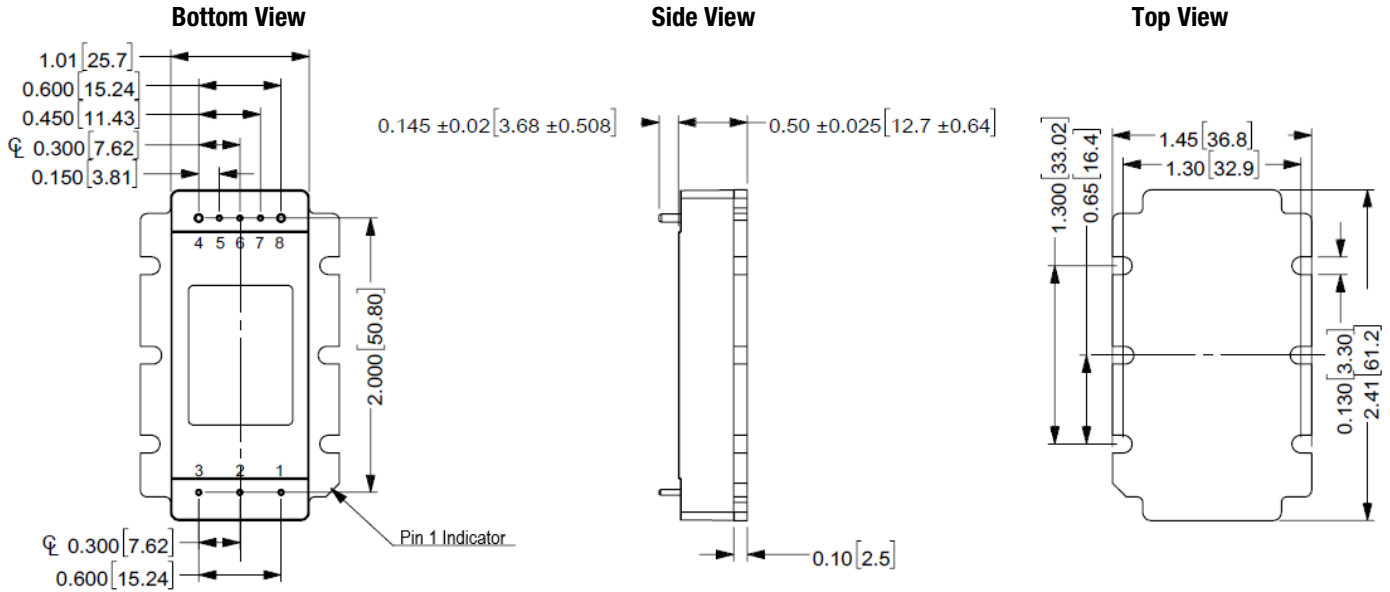

Standard Baseplate (Non-flanged):

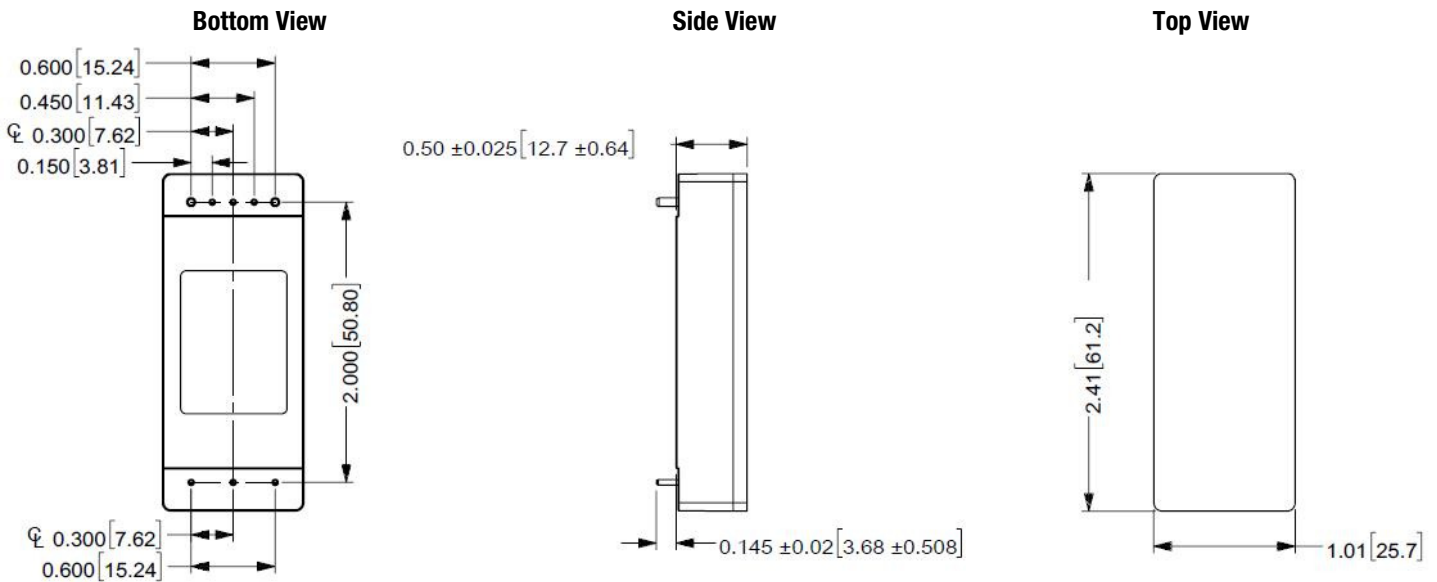

Notes:
 All dimensions are in Inches [Millimeters].
 Tolerance: x.xx in, ±0.02 (x.x mm, ±0.5).
 x.xxx in, ±0.01 (x.xx mm, ±0.25).
 Pin diameter: 0.04in for Pin no. 1-3 and 5-7
 0.062in for Pin no. 4 and 8
 Pin material: See General Data, Mechanical Specifications

INPUT/OUTPUT CONNECTIONS	
Pin	Function
1	Vin(+)
2	On/Off Control
3	Vin(-)
4	Vout(-)
5	Sense(-)
6	Trim
7	Sense(+)
8	Vout(+)

RECOMMENDED FOOTPRINT FOR
STANDARD BASEPLATE CONVERTER

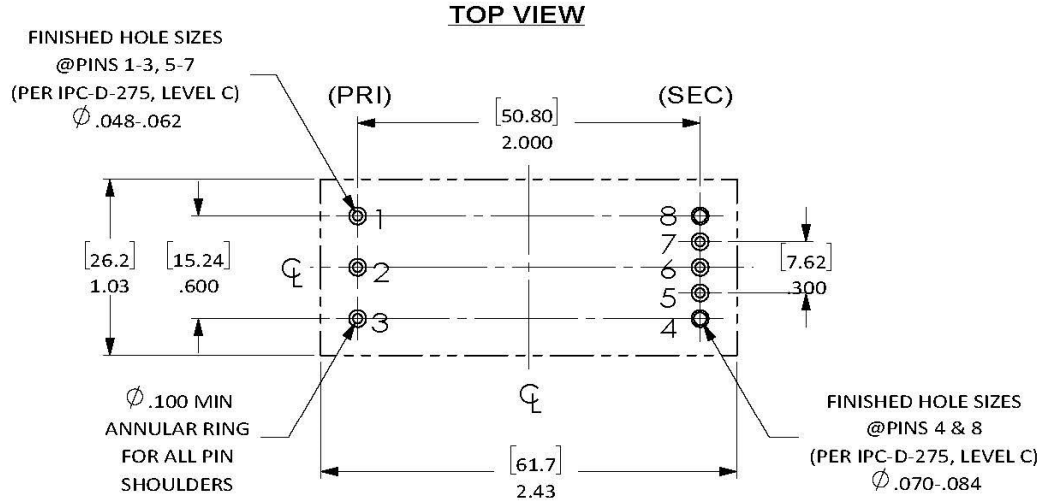

RECOMMENDED FOOTPRINT FOR
FLANGED BASEPLATE CONVERTER

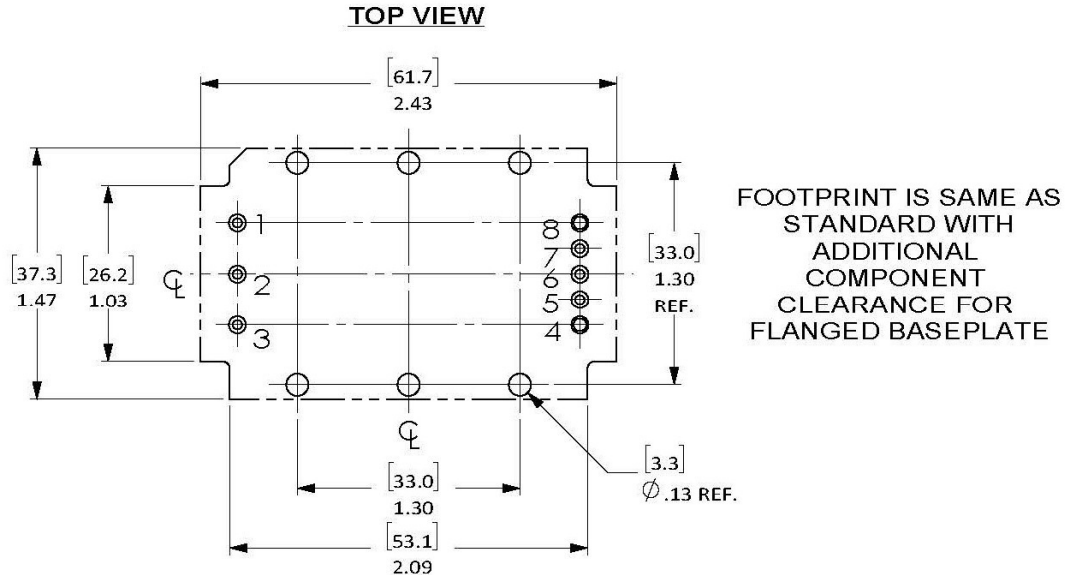

NOTES:

UNLESS OTHERWISE SPECIFIED;

1. ALL DIMENSION ARE IN INCHES[MILLIMETER];
2. ALL TOLERANCES: x.xx in, ± 0.02 in (x.x mm, ± 0.5 mm);
x.xxx in, ± 0.01 in (x.x mm, ± 0.25 mm);

INPUT/OUTPUT CONNECTIONS

Pin	Function
1	Vin(+)
2	On/Off Control
3	Vin(-)
4	Vout(-)
5	Sense(-)
6	Trim
7	Sense(+)
8	Vout(+)

SHIPPING TRAYS AND BOX DIMENSIONS

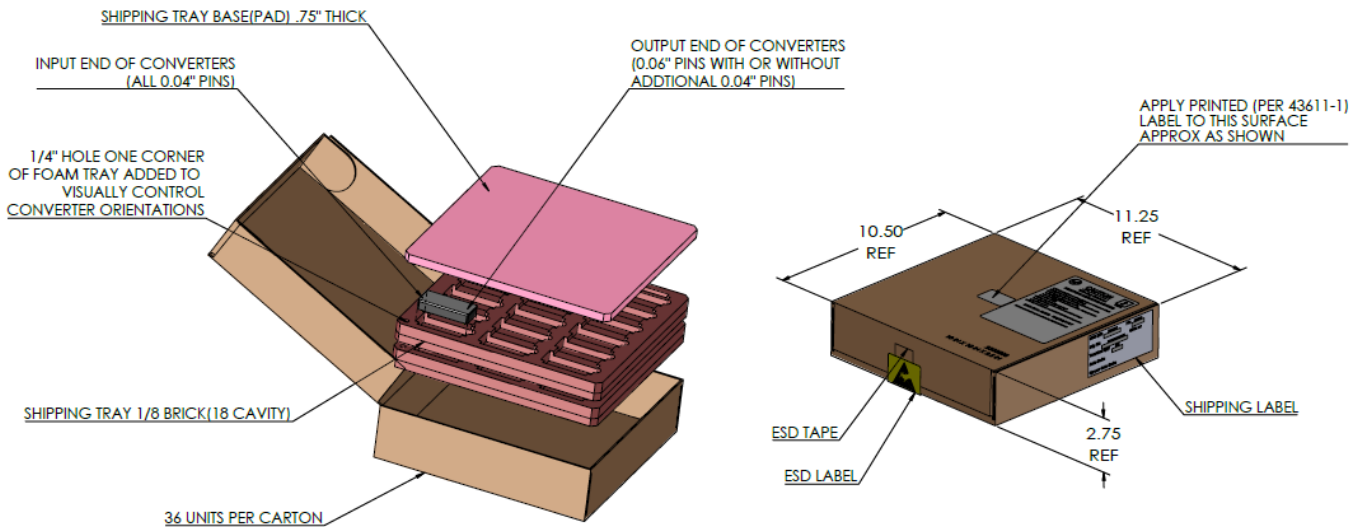

SHIPPING TRAY DIMENSIONS

Material: Low density closed cell polyethylene static dissipative foam

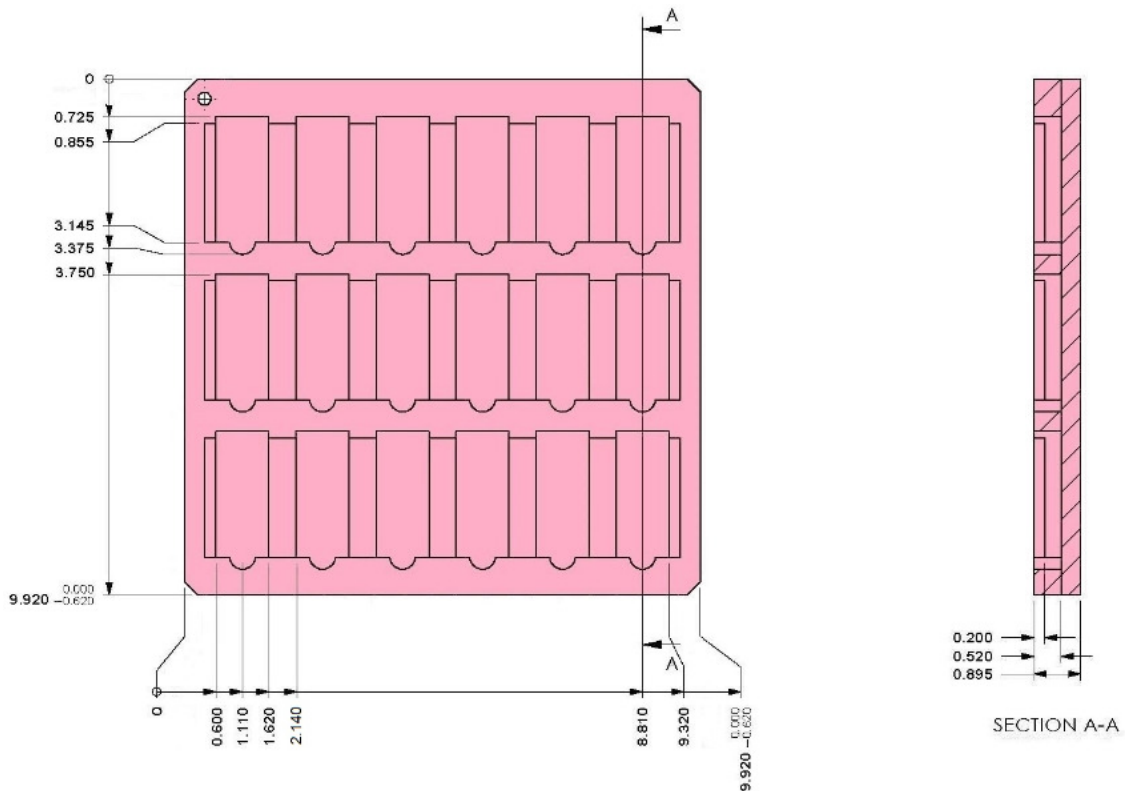

TECHNICAL NOTES

Input Fusing

Most if not all applications and/or safety agencies will require the installation of an external input fuse for power conversion components to meet specific safety agency requirements. For the IRE series DC-DC converters, we recommend the use of a fast blow fuse, installed in the ungrounded input supply line. See recommended fuse value specified for each module.

All relevant national and international safety standards and regulations must be observed by the installer. For system safety agency approvals, the converters must be installed in compliance with the requirements of the end use safety standard, i.e. IEC/EN/UL60950-1.

Input Reverse-Polarity Protection

If the input voltage polarity is accidentally reversed, an internal diode will become forward biased and likely draw excessive current from the power source. If this source is not current limited or the circuit appropriately fused, it could cause permanent damage to the converter.

There is no Input reverse-Polarity Protection. An external circuit must be added.

Input Under-Voltage Shutdown and Start-Up Threshold

Under normal start-up conditions, devices will not begin to regulate properly until the ramping-up input voltage exceeds the Start-Up Threshold Voltage. Once operating, devices will not turn off until the input voltage drops below the Under-Voltage Shutdown limit. Subsequent re-start will not occur until the input is brought back up to the Start-Up Threshold. This built in hysteresis prevents any unstable on/off situations from occurring at a single input voltage.

Start-Up Time

The V_{IN} to V_{OUT} Start-Up Time is the time interval between the points at which the ramping input voltage crosses the Start-Up Threshold and the fully loaded output voltage reaches and remains above 90% of its specified output voltage.

Actual measured time will vary with input source impedance, external input capacitance, and the slew rate and final value of the input voltage as it appears at the converter. The IRE Series implements a soft start circuit to limit the duty cycle of its PWM controller at power up, thereby limiting the input inrush current.

The On/Off Control to V_{OUT} start-up time assumes the converter has its nominal input voltage applied but is turned off via the On/Off Control pin. The specification defines the interval between the points at which the converter is turned on (released) and the fully loaded output voltage reaches and remains above 90% of its specified output voltage. Similar to the V_{IN} to V_{OUT} start-up, the On/Off Control to V_{OUT} start-up time is also governed by the internal soft start circuitry and external load capacitance. The difference in start-up time from V_{IN} to V_{OUT} and from On/Off Control to V_{OUT} is therefore insignificant.

Input Source Impedance

The input of a dc-dc converter acts like a negative resistance and must be compensated by providing a low impedance input source to insure the system will be stable. The dc-dc converter performance and stability will be compromised if the source is not compensated properly

A low ESR Cbus in the input circuit shown below is a practical solution that can be used to minimize the effects of inductance in the input traces. For optimum performance, components should be mounted as close to the DC-DC converter as possible.

There are several papers that have been written regarding this topic and we suggest that the power systems engineer review for further information:

References:

- 1) Middlebrook, R.D. "Input Filter Considerations in Design and Application of Switching Regulators" IEE IAS Annual Meeting, 1976
- 2) Feng, X. et al, "individual Load Impedance Specification for a Stable DC

I/O Filtering, Input Ripple Current, and Output Noise

All models in the IRE Series are tested/specified for input reflected ripple current, input terminal ripple current and output noise using the specified external input/output components/circuits and layout as shown in the following figures. External input capacitors (Cbus in Figure 1 Measuring Input Ripple Current and Output Noise) serve primarily as energy-storage elements, minimizing line voltage variations caused by transient IR drops in conductors from backplane to the DC-DC. Input caps should be selected for bulk capacitance (at appropriate frequencies), low ESR, and high RMS-ripple-current ratings. The switching nature of DC-DC converters requires that dc voltage sources have low ac impedance as highly inductive source impedance can affect system stability. The input ripple is measured with simulated source impedance L_s . Capacitor C_s to offset possible battery impedance. Your specific system configuration may necessitate additional considerations.

In critical applications, output ripple/noise (Figure 1. Measurement Input Ripple and Output Noise Circuit) may be reduced below specified limits using filtering techniques, the simplest of which is the installation of additional external output capacitors. They function as true filter elements and should be selected for bulk capacitance, low ESR and appropriate frequency response. Care must be taken not to exceed the maximum rated C_{out} specification as this can cause system instability and possible failure of the dc-dc module.

All external capacitors should have appropriate voltage ratings and be located as close to the converter as possible. Temperature variations for all relevant parameters should also be taken carefully into consideration. The most effective combination of external I/O capacitors will be a function of line voltage and source impedance, as well as particular load and layout conditions.

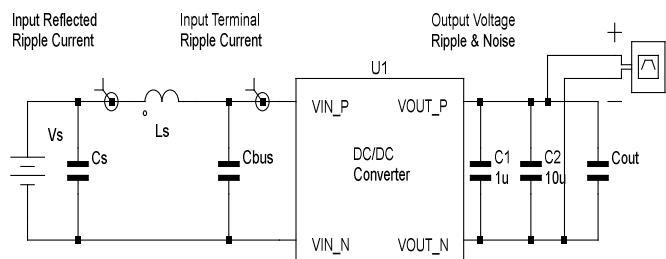

Figure T1. Measurement Input Ripple and Output Noise Circuit

Floating Outputs

Since these are isolated DC-DC converters, their outputs are “floating” with respect to their input. Designers will normally use the –Output as the ground/return of the load circuit. You can however, use the +Output as ground/return to effectively reverse the output polarity.

Thermal Shutdown

The IRE series converters are equipped with thermal-shutdown circuitry. If environmental conditions cause the temperature of the DC-DC converter to rise above the designed operating temperature, a precision temperature sensor will power down the unit. When the internal temperature decreases below the threshold of the temperature sensor, the unit will self-start.

The thermal shutdown is set to a point where the semiconductors should never exceed their “maximum ratings”. The thermal shutdown is set to avoid “nuisance” shutdown under fault conditions. i.e. if the air conditioning goes down in the data center, the module can run at a higher temperature for some time. We do not recommend that you run the module continuously above the thermal derating curve recommendations.

It is recommended that you fully understand the “recommended operating temperature” and verify that under normal operating conditions the module temperature is not exceeded in your application. See Performance/Functional Specifications.

Output Over-Voltage Protection

Vout is controlled via a closed loop system and monitored for fault conditions (over voltage, over current) such as an over-voltage condition. If Vout for any reason rises above the specified OVP set point the converter will shut down causing Vout to decrease rapidly (depending on load conditions). Following a time-out period the module will restart causing Vout to ramp to its specified set-point. If the fault condition persists and Vout again exceeds the OVP set point the converter will again enter the shutdown cycle. This on/off cycling is referred to as “hiccup” mode. When the fault condition has been corrected the module will return to normal operations.

Current Limiting

As soon as the output current increases to approximately 130% of its rated value, the DC-DC converter will go into a current-limiting mode. In this condition, the output voltage will decrease proportionately with increases in output current, thereby maintaining somewhat constant power dissipation. This is commonly referred to as power limiting. Current limit inception is defined as the point at which the full-power output voltage falls below the specified tolerance. See Performance/Functional Specifications. If the load current, being drawn from the converter, is significant enough, the unit will go into a short circuit condition as described below.

Short Circuit Condition

When a converter is in current-limit mode, the output voltage will drop as the output current demand increases. If the output voltage drops too low, the magnetically coupled voltage used to develop primary side voltages will also drop, thereby shutting down the PWM controller. Following a time-out period, the PWM will restart causing the output voltage to begin ramping to their appropriate value. If the short-circuit condition persists, another shutdown cycle will be initiated. This on/off cycling is referred to as “hiccup” mode. The hiccup cycling reduces the average output current, thereby preventing internal temperatures from rising to excessive levels. The IRE Series is capable of enduring an indefinite short circuit output condition.

On/Off Control

The input-side, remote On/Off Control function can be ordered to operate with

Positive (“P” suffix) logic models are enabled when the On/Off pin is left open or is pulled high (see specifications) with respect to the –Input. Positive-logic devices are disabled when the on/off pin is pulled low with respect to the –Input. Negative (“N” suffix) logic devices are off when the On/Off pin is left open or is pulled high (see specifications), and on when the pin is pulled low with respect to the –Input. See specifications.

Dynamic control of the remote on/off function is best accomplished with a mechanical relay or an open-collector/open-drain drive circuit (optically isolated if appropriate). The drive circuit should be able to sink appropriate current (see Performance Specifications) when activated and withstand appropriate voltage when deactivated.

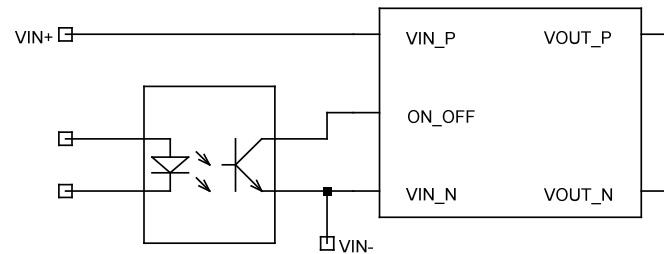

Figure T2. ON/OFF Control Circuit

Remote Sense

Note: The Sense and Vout lines are internally connected through low-value resistors. Nevertheless, if the sense function is not used for remote regulation, the user should connect the +Sense to +Vout and –Sense to –Vout directly at the DC-DC converter pins. IRE series converters employ a sense feature to provide point of use regulation, thereby overcoming moderate IR drops in PCB conductors or cabling. The remote sense lines carry very little current and therefore require minimal cross-sectional-area conductors. The sense lines, which are coupled to their respective output lines, are used by the feedback control-loop to regulate the output. As such, they are not low impedance points and must be treated with care in layouts and cabling. Sense lines on a PCB should be run adjacent to dc signals, preferably ground.

$$[V_{out(+)} - V_{out(-)}] - [Sense(+) - Sense(-)] \leq 10\% \times V_{out}$$

In cables and discrete wiring applications, twisted pair or other techniques should be used. Output over-voltage protection is monitored at the output voltage pin, not the Sense pin. Therefore, excessive voltage differences between Vout and Sense in conjunction with trim adjustment of the output voltage can cause the over-voltage protection circuitry to activate (see Performance Specifications for over-voltage limits).

Power derating is based on maximum output current and voltage at the converter’s output pins. Use of trim and sense functions can cause output voltages to increase, thereby increasing output power beyond the converter’s specified rating, or cause output voltages to climb into the output over-voltage region. Therefore, the designer must ensure:

$$(V_{out \text{ at pins}}) \times (I_{out}) \leq \text{rated output power}$$

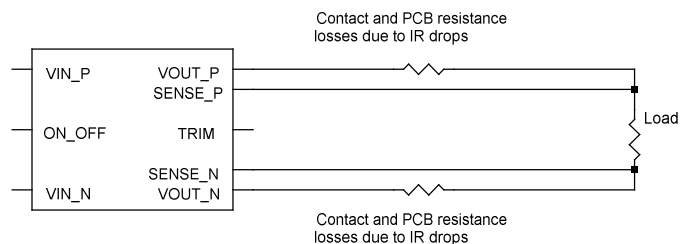

Figure T3. Remote Sense Circuit

Output Voltage Adjustment (TRIM)

The TRIM input permits the user to adjust the output voltage across the sense leads up or down according to the trim range specifications.

To decrease the output voltage, the user should connect a resistor between TRIM pin and SENSE (-) pin. For a desired decrease of the nominal output voltage, the value of the resistor should be:

$$R_{trimdown} = \frac{5.11}{\Delta\%} - 10.22 \text{ (k}\Omega\text{)}$$

Where:

$$\Delta\% = \left| \frac{V_{nominal} - V_{desired}}{V_{nominal}} \right|$$

To increase the output voltage, the user should connect a resistor between TRIM pin and SENSE (+) pin. For a desired increase of the nominal output voltage, the value of the resistor should be:

$$R_{trimup} = \frac{5.11 \times V_{nominal} \times (1 + \Delta\%)}{1.225 \times \Delta\%} - \frac{5.11}{\Delta\%} - 10.22 \text{ (k}\Omega\text{)}$$

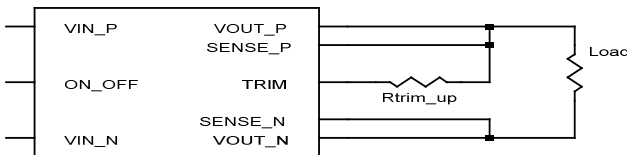

Figure 4. Trim Up connections to increase Vout

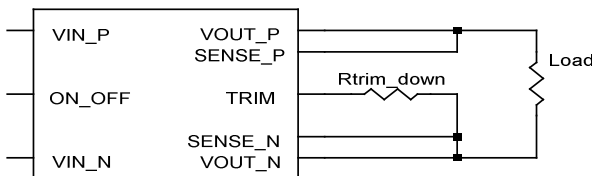

Figure T5. Trim Down connections to decrease Vout

Through-Hole Soldering Guidelines

Murata Power Solutions recommends the TH soldering specifications below when installing these converters. These specifications vary depending on the solder type. Exceeding these specifications may cause damage to the product. Your production environment may differ; therefore please thoroughly review these guidelines with your process engineers

Wave Solder Operations for Through-Hole Mounted Products (THMT)		
For Solder based on:	Sn/Ag/Cu	Sn/Pb
Maximum Preheat Temperature	115° C.	105° C.
Maximum Pot Temperature	270° C.	250° C.
Maximum Solder Dwell Time	7 seconds	6 seconds

Some detailed trim resistance values are listed in the table below.

PN	Trim Up Resistance		Trim Down Resistance	
	Vout(V)	Rtrim_up(kΩ)	Vout(V)	Rtrim_down kΩ)
IRE-5/24-Q12	5.05	1585	4.9	245.3
	5.1	798	4.8	117.5
	5.2	404	4.6	53.7
	5.25	326	4.5	40.9
	5.3	273	4.4	32.4
	5.4	207	4.2	21.7
	5.5	168	4.0	15.3
IRE-12/10-Q12	12.12	4535	11.76	245.3
	12.36	1538	11.28	74.9
	12.6	939	10.8	40.9
	12.72	789	10.56	32.4
	12.84	682	10.32	26.3
	13.08	539	9.84	18.2
	13.2	489	9.6	15.3
IRE-24/5-Q12	24.24	9590	23.52	245.3
	24.48	4840	23.04	117.5
	24.96	2465	22.08	53.7
	25.44	1673	21.12	32.4
	25.68	1447	20.64	26.3
	25.92	1277	20.16	21.7
	26.4	1040	19.2	15.3

Note: The Trim feature does not affect the voltage at which the output over-voltage protection (OVP) circuit is triggered. Trimming the output voltage too high may cause the over-voltage protection circuit to trigger, particularly during load transients. For the converter to meet its rated specifications the maximum variation of the dc value of Vout, due to both trimming and remote load voltage drop should not exceed the output voltage trim range.

Murata Power Solutions, Inc.
129 Flanders Road, Westborough, MA 01581 USA
ISO 9001 and 14001 REGISTERED



This product is subject to the following [operating requirements](#) and the [Life and Safety Critical Application Sales Policy](#):
Refer to: <http://www.murata-ps.com/requirements/>

Murata Power Solutions, Inc. makes no representation that the use of its products in the circuits described herein, or the use of other technical information contained herein, will not infringe upon existing or future patent rights. The descriptions contained herein do not imply the granting of licenses to make, use, or sell equipment constructed in accordance therewith. Specifications are subject to change without notice.
© 2020 Murata Power Solutions, Inc.