

## X.FL Series

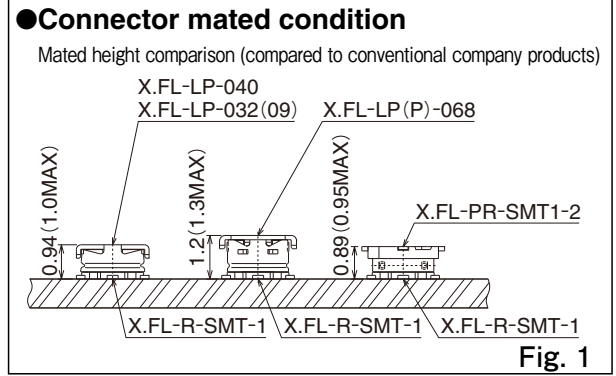

### ■Features

#### 1. A Low mated height of 0.94 or 1.2 mm (maximum of 1.0 or 1.3 mm)

When connected this series delivers a world class low mated height of 1.0 or 1.3 mm (see Figure 1).

#### 2. Minimal mounting area required

The receptacle requires a footprint of only 3.4 mm<sup>2</sup>, which is the same footprint as our W.FL and W.FL2 series. In addition, the same land patterns can be used. (Note: The X.FL series has no mating compatibility with the W.FL2 and W.FL series.)

#### 3. Ultra lightweight

The world's smallest and lightest class of coaxial connectors

Receptacle: 3.2 mg

Right angle plug: 22.0 mg (068), 14.4 mg (040), and 15.7 mg (032)

Plug receptacle: 5.5 mg

#### 4. High frequency transmission

This series offers the high performance needed to meet the requirements of many different miniature devices, featuring a DC to 6 GHz capacity. X.FL-LP(P)-068 supports up to 12 GHz.

#### 5. Automatic board placement

This product is available in embossed packaging; this allows the plug and receptacles to be automatically mounted.

#### 6. The use of ultra-fine coaxial (fluorinated resin insulated) cables

The use of ultra-fine coaxial (fluorinated resin insulated) cables on these connectors offer the ability to complete connections in small, confined spaces with a smooth, easy operation.

#### 7. Simple connector mating / unmating

Dedicated tools are available to ensure that proper mating/unmating of this connector takes place.

### ■Product Specifications

Ratings	Nominal characteristic impedance	50Ω	Operating temperature range	-40°C to +90°C (RH 90% or less)
	Frequency range	DC~6GHz	Storage humidity range	-30°C to +70°C (RH 90% or less)

Item	Specifications (for each plug type)			
	X.FL-LP-040	X.FL-LP-032(09)	X.FL-LP(P)-068	X.FL-PR-SMT1-2
1. Contact resistance	(Center) Maximum of 20 mΩ (Outer) Maximum of 10 mΩ	(Center) Maximum of 25 mΩ (Outer) Maximum of 25 mΩ	(Center) Maximum of 25 mΩ (Outer) Maximum of 10 mΩ	(Center) Maximum of 25 mΩ (Outer) Maximum of 15 mΩ
2. V.S.W.R. (*)	1.3 or less (DC to 3 GHz) 1.4 or less (3 to 6 GHz)	1.3 or less (DC to 3 GHz) 1.4 or less (3 to 6 GHz)	1.3 or less (DC to 3 GHz) 1.4 or less (3 to 6 GHz) 1.7 or less (6 to 12 GHz)	1.3 or less (DC to 3 GHz) 1.5 or less (3 to 6 GHz)
3. Insulation resistance	Minimum of 500 MΩ , 100 V DC			
4. Withstanding voltage	200 V AC, 1 minute			

\*V.S.W.R. Measurement System (plug type)

The above V.S.W.R. specification values were measured using the measurement system shown below.

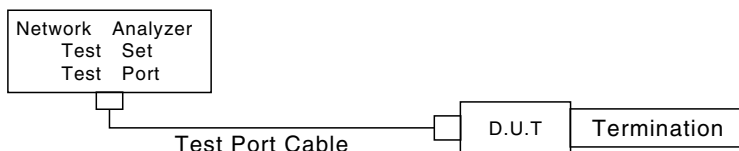

Note 1: Cable type connectors were measured with SMA conversion adapters attached to both ends of the harness product of a suitable 100 cm cable.

Note 2: Board type connectors were mounted to a 50 glass epoxy board and measurements were conducted with SMA conversion adapters attached.

## ■ Cable Assembly (Plug)

### ● X.FL-LP-040 (Applicable cable: outer diameter $\phi 0.81$ or $\phi 0.64$ )

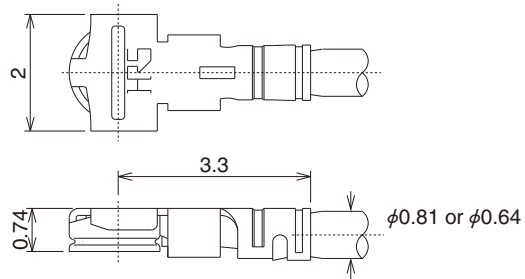

#### Material / Finishes

Part	Material	Finish and remarks
Shell	Phosphor bronze	Gold plated
Insulator	LCP resin	Black, UL94V-0
Female contact	Phosphor bronze	Gold plated

### ● X.FL-LP-032 (09) (Applicable cable: outer diameter $\phi 0.5$ )

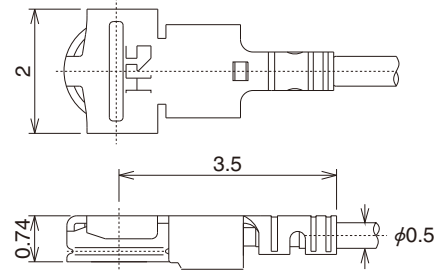

#### Material / Finishes

Part	Material	Finish and remarks
Shell	Phosphor bronze	Partially gold plated
Insulator	LCP resin	Black, UL94V-0
Female contact	Phosphor bronze	Gold plated

### ● X.FL-LP (P) -068 (Applicable cable: outer diameter $\phi 1.13$ )

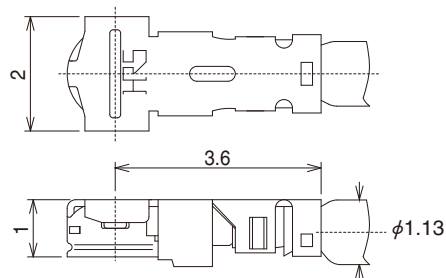

#### Material / Finishes

Part	Material	Finish and remarks
Shell	Phosphor bronze	Partially gold plated
Insulator	LCP resin	Black, UL94V-0
Female contact	Phosphor bronze	Gold plated

### ● Cable Guide

Description	Cable Type	Cable Specification						
		Center Conductor	Dielectric Diameter	Outer Conductor	Jacket Diameter	Nominal Impedance	Nominal attenuation	
							3GHz	6GHz
$\phi 0.81$ mm Coaxial Cable	04	7/0.05 (36 AWG) Silver plated annealed copper wire	$\phi 0.40$ FEP	Single-layer braided wire Tin plated	$\phi 0.81$ FEP	50	5.6dB/m	8.3dB/m
$\phi 0.64$ mm Coaxial Cable	044	7/0.05 (36 AWG) Silver plated annealed copper wire	$\phi 0.44$ PFA	Fiber or paper covered copper winding wire Tin plated	$\phi 0.64$ PFA	50	5.85dB/m	8.59dB/m
$\phi 0.5$ mm Coaxial Cable	032	7/0.04 (38 AWG) Silver plated copper alloy wire	$\phi 0.32$ PFA	Fiber or paper covered copper winding wire Tin plated	$\phi 0.5$ PFA	50	6.13dB/m	9.09dB/m
$\phi 1.13$ mm Coaxial Cable	068	7/0.08 (32 AWG) Silver plated annealed copper wire	$\phi 0.68$ FEP	Single-layer braided wire Tin plated	$\phi 1.13$ FEP	50	3.7dB/m	5.3dB/m

## How to Specify Plug Cable Assembly

The dimensions of a cable assembly of the X.FL series should be specified as follows:

[Double-Ended Cable Assembly]

[Single-Ended Cable Assembly]

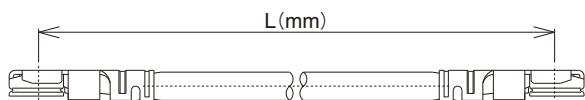

Single ended assemblies come with a blunt cut on the non-terminated end. Please contact us if special strip requirements are needed.

## Product Number Structure

Refer to the charts below for determining specific part number characteristics.

Please select connectors listed in this catalog when placing orders and be sure to check the latest delivery specifications at the time of ordering the product.

### ● Used Plug: X.FL-LP-040

#### ◇ φ0.81 Coaxial Cable

Double-Ended **X.FL - 2LP - 04K [ ] TV - A - (L)**  
 ① ② ③ ④ ⑤ ⑥

Single-Ended **X.FL - LP - 04K [ ] TV - A - (L)**  
 ① ② ③ ④ ⑤ ⑥

① Series name: X.FL series	④ Cable color 1: White, 2: Black
② Assembly type LP: Single-ended, 2LP: Double-ended	⑤ Cable outer conductor TV: Tin plated braided wire
③ Cable type 04K: φ0.81 coaxial cable	⑥ Total length L (mm) L length in mm

#### ◇ φ0.64 Coaxial Cable

Double-Ended **X.FL - 2LP - 044N [ ] TS - A - (L)**  
 ① ② ③ ④ ⑤ ⑥

Single-Ended **X.FL - LP - 044N [ ] TS - A - (L)**  
 ① ② ③ ④ ⑤ ⑥

① Series name: X.FL series	④ Cable color 1: White, 2: Black
② Assembly type LP: Single-ended, 2LP: Double-ended	⑤ Cable outer conductor TS: Tin plated fiber or paper covered copper winding wire
③ Cable type 044N: φ0.64 coaxial cable	⑥ Total length L (mm) L length in mm

Plug: X.FL-LP-032 (09) φ0.5 coaxial cable

Double-Ended **X.FL - 2LP9 - 032H [ ] TS - A - (L)**  
 ① ② ③ ④ ⑤ ⑥

Single-Ended **X.FL - LP9 - 032H [ ] TS - A - (L)**  
 ① ② ③ ④ ⑤ ⑥

① Series name: X.FL series	④ Cable color 1: White, 2: Black
② Assembly type LP9: Single-ended, 2LP9: Double-ended	⑤ Cable outer conductor TS: Tin plated fiber or paper covered copper winding wire
③ Cable type 032H: φ0.5 coaxial cable	⑥ Total length L (mm) L length in mm

Plug: X.FL-LP (P)-068  $\phi$ 1.13 coaxial cable

Double-Ended **X.FL - 2LP P - 068W [ ] TV - A - (L)**

Single-Ended **X.FL - LP P - 068W [ ] TV - A - (L)**

① Series name: X.FL series	⑤ Cable color 1: Grey, 2: Black, 3: White
② Assembly type LP: Single-ended, 2LP: Double-ended	⑥ Cable outer conductor TV: Tin plated braided wire
③ Connection type Batch connection type	⑦ Total length L (mm) L length in mm
④ Cable type 068W: $\phi$ 1.13 coaxial cable	

● Standard Tolerances for (L)

L (mm)	Standard Tolerances (mm)
35 $\leq$ L $\leq$ 200	$\pm 4$
200 < L $\leq$ 500	$\pm 8$

L (mm)	Standard Tolerances (mm)
500 < L $\leq$ 1000	$\pm 12$
1000 < L	$\pm 1.5\%$

Note: Minimum available length (L) is 35 mm.

■ Receptacles



◆ Recommended PCB Mounting Pattern (\*1)

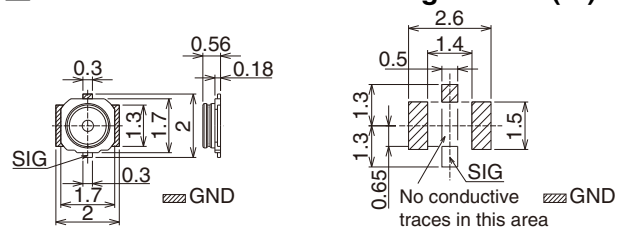

\*1) The pattern is the same as the W.FL and W.FL2 connectors.

Part No.	HRS No	Packaging	RoHS
X.FL-R-SMT-1 (80)	CL331-0701-8-80	Reel packaging 10,000 pieces per reel	○

● Embossed Carrier Tape Dimensions (JIS-C-0806 compliant)

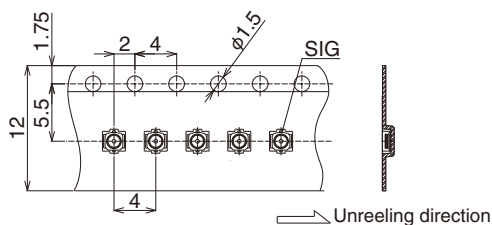

● Reel Dimensions

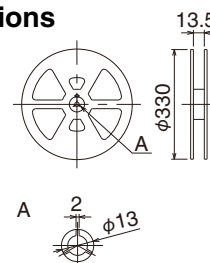

■ Plug Receptacles

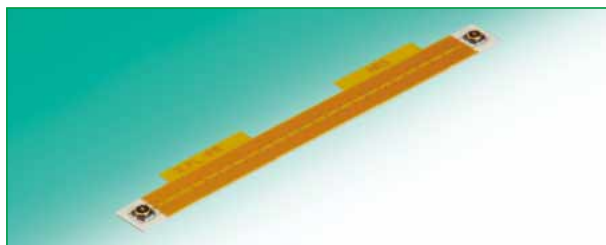

◆ Recommended PCB Mounting Pattern

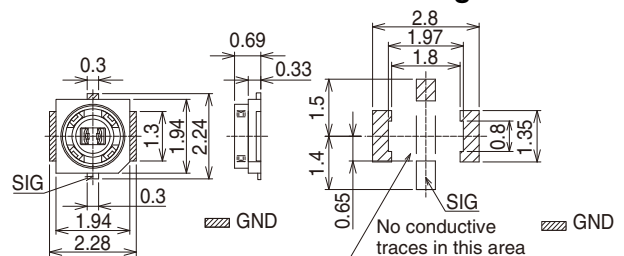

Part No.	HRS No	Packaging	RoHS
X.FL-PR-SMT1-2 (80)	CL331-0713-7-80	Reel packaging 10,000 pieces per reel	○

● Embossed Carrier Tape Dimensions (JIS-C-0806 compliant)

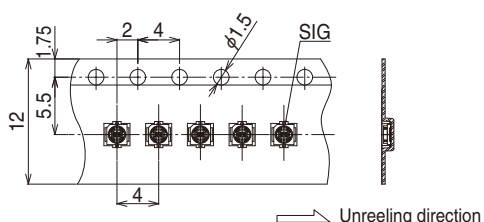

● Reel Dimensions

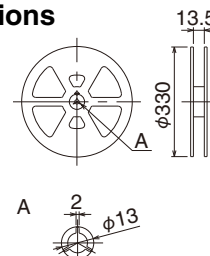

## ■ Conversion Adapters

### ● SMA Conversion Adapter (Mating portion - X.FL side: jack - SMA side: plug)



Note: The X.FL side mating portions has a lower lock retention force than the regular product, so that the adapter cannot be used for purposes other than performance measurements.

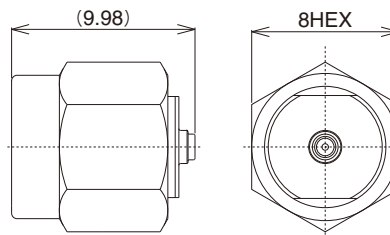

Part No.	HRS No	RoHS
HRMP-X.FLJ	CL311-0435-1	○

### ● SMA Conversion Adapter (Mating portion - X.FL side: plug - SMA side: jack)



Note: The X.FL side mating portions has a lower lock retention force than the regular product, so that the adapter cannot be used for purposes other than performance measurements.

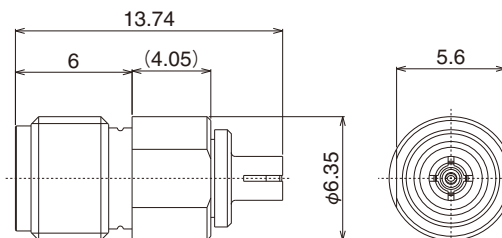

Part No.	HRS No	RoHS
HRMJ-X.FLP	CL311-0436-4	○

### ● SMA Conversion Adapter (Mating portion - X.FL side: plug (w/o lock) - SMA side: jack)



Note: This connector is used by compressing the mating portion of X.FL side onto the X.F L-R-S M T-1 portion.

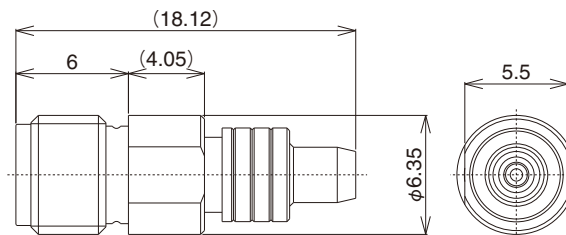

Part No.	HRS No	RoHS
HRMJ-X.FLP-ST3	CL311-0450-5	○

## ◆ Tool

### ● Plug Mating Tool (Space-Saving Type)

This tool is used for mating a plug.

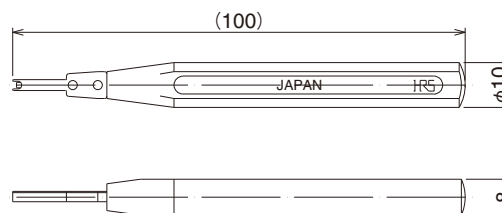

Part No.	HRS No	RoHS
W.FL-LP-IN ※	CL331-0323-2	○

\*This tool can be also used for the X.FL series.

### ● Plug Mating and Unmating Tool

This is a combination tool that has both of the mating and unmating tool at either end.

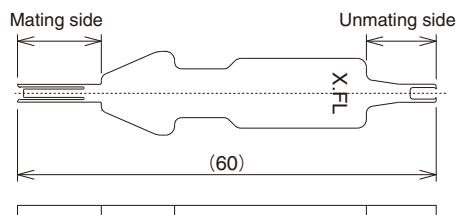
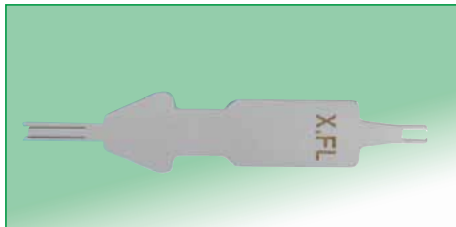

Part No.	HRS No	RoHS
X.FL-LP-IN.OUT1	CL331-0715-2	○

◆ Usage Precautions

1. Plugs

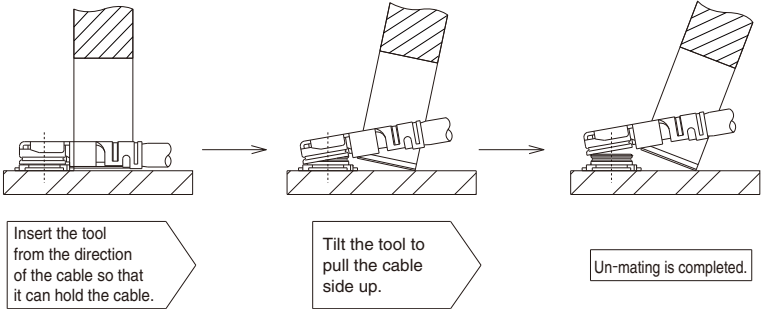
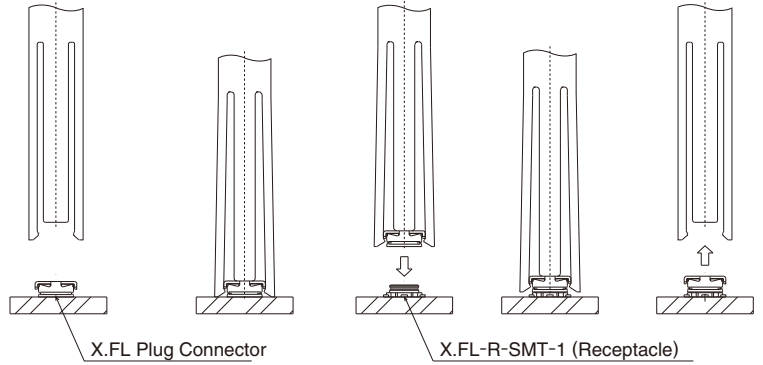
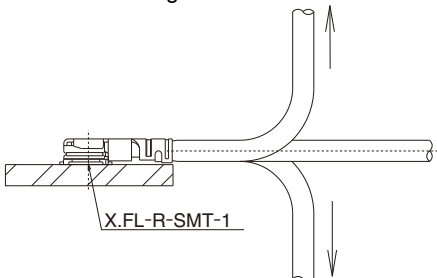
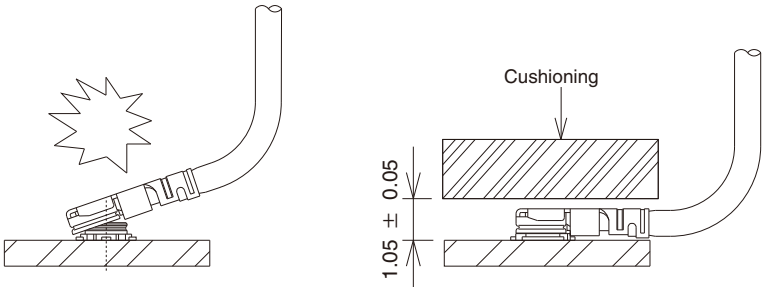
<p>(1) Mating / un-mating</p>	<p>1. To un-mate a connector, use the unmating side of the plug mating and unmating tool X.FL-LP-IN.OUT1 as shown in the following figure.                  [How to un-mate a plug]</p>  <p>Never un-mate the plug by pulling the cable. It may cause a failure of the connector.</p> <p>2. To mate a connector, use the mating side of the plug mating and unmating tool X.FL-LP-IN.OUT1 or the plug mating tool W.FL-LP-IN. Align the mating axes between both of the connectors and check that the shell is properly aligned. The connector should be inserted perpendicularly as much as possible. (See the following figure)                  Do not attempt to insert the connector at an extreme angle. It may cause the connector to fail.</p> 
<p>(2) Allowable load to a cable that is mated</p>	<p>After the connector is mated, do not apply a load to the cable in excess of the values indicated in the figure below.</p>  <p>2 N or less (X.FL-LP-040.X.FL-LP(P)-068)                  1 N or less (X.FL-LP-032)                  (while wiring after mating)</p> <p>When the cable is routed in such a direction that lifts the cable, it is recommended that cushioning should be placed on the plug to prevent the connector from unmating (see the example below).</p> 
<p>(3) Precautions</p>	<p>Do not mate or unmate a connector with an excessive prying force. It may cause a failure of the connector.</p>

Jan. 1. 2021 Copyright 2021 HIROSE ELECTRIC CO., LTD. All Rights Reserved.

## 2. Plug Receptacles

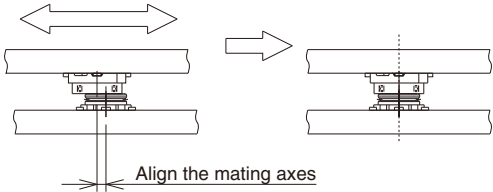
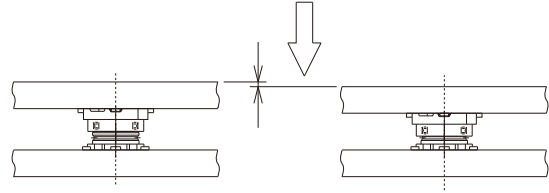
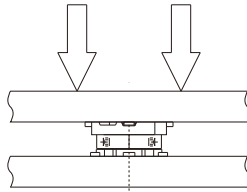
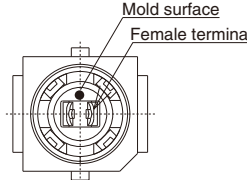
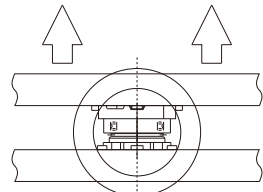
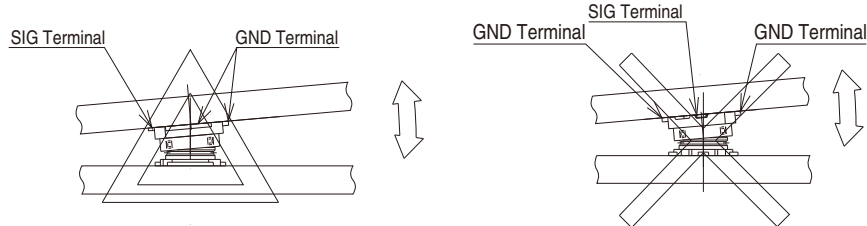
<p>(1) Mating</p>	<p>This product should be mated by hand. Do not apply an excessive load or over handle during the mating process. It may cause the connector to fail.</p> <p>[Mating procedure]</p> <ol style="list-style-type: none"> <li>Before inserting the connector, bring the mating surface of the plug receptacle (X.F L-P R-S M T1-2) into gentle contact with that of the receptacle (X.F L-R-SMT-1) and slide them back and forth and around so that the mating axes are aligned.</li> </ol>  <p>Align the mating axes</p> <ol style="list-style-type: none"> <li>Also make sure the PCBs the parts are mounted on are not allowed to move relative to each other. When the connector has been slightly mated with the receptacle, the connector will not move from any side-to-side or front-to-back forces applied to it.</li> </ol>  <ol style="list-style-type: none"> <li>Push the connector down perpendicularly until you feel it click.</li> </ol>  <ol style="list-style-type: none"> <li>If the mating axes are not aligned, it will fail to make a complete connection. When there has been a failure to make a connection due to misaligned mating axes, Please check that the female terminal contacts on the plug receptacle have not been damaged</li> </ol> 
<p>(2) Unmating</p>	<p>When unmating a connector, it is desirable to pull the connector in the direction perpendicular to the surface on which the connector is mounted. However, unmating the FPC in a perpendicular direction can be difficult when an FPC is detached from a thin printed circuit board.</p>  <p>When you find it difficult to unmate the connector, detach it to an oblique direction as shown in the left figure below. Avoid detaching the connector in a way as shown in the right figure.</p>  <p>SIG Terminal      GND Terminal</p> <p>GND Terminal      SIG Terminal      GND Terminal</p>
<p>(3) Precautions</p>	<p>Do not mate or unmate a connector with an excessive prying force. It may cause a failure of the connector.</p>

Jan. 1. 2021 Copyright 2021 HIROSE ELECTRIC CO., LTD. All Rights Reserved.

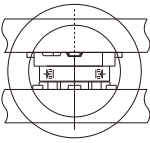
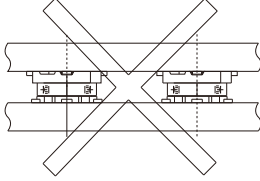
(4) Notes for mounting	<p>Avoid mounting multiple connectors of this type on the same circuit board. (If it is unavoidable to mount multiple connectors, take necessary measures for use, such as separating the circuit board between the connectors.)</p> <p>When the connector is mounted on an FPC, insufficient stiffness may lead to land pattern separation or solder separation. It is recommended that the FPC should be lined with a stiffening film.</p> <div style="display: flex; justify-content: space-around; align-items: center;">   </div>
(5) Precautions	<ol style="list-style-type: none"> <li>1. Do not mate or unmate a connector with an excessive prying force. It may cause a failure of the connector.</li> <li>2. The connector may become disconnected if it is dropped, or extreme stress is applied to the FPC. To prevent this from happening, fix the connector in place by holding it with an added portion of the case or some type of cushioning material.</li> </ol>

### 3. Reflow conditions of receptacles and plug receptacles

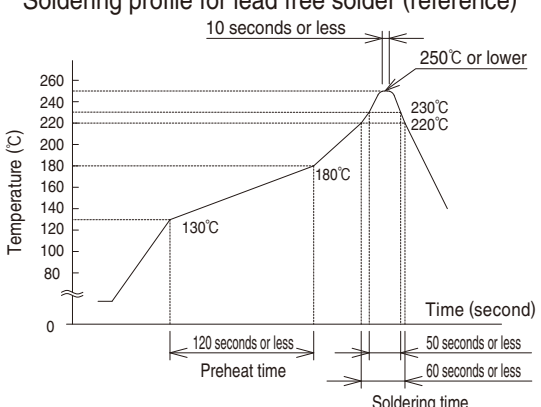
(1) Recommended reflow temperature profile [reference]	<p style="text-align: center;"><b>Soldering profile for lead free solder (reference)</b></p>  <ol style="list-style-type: none"> <li>1. The temperatures indicated are the surface temperatures on the printed circuit board at the points of contact with the terminals.</li> <li>2. Reflow soldering should be performed at a peak temperature of 250°C or less at the surface of the printed circuit board.</li> <li>3. The temperature profile varies depending on conditions such as the size of the printed circuit board, the solder paste type, and solder thickness.</li> </ol>
(2) Recommended metal mask thickness	0.1mm~0.12mm
(3) Reflow cycles	2 times

### 4. Operating Environment and Storage Conditions

(1) Operating environment	<p>This product was designed under the assumption that it would be used in a normal operating environment.</p> <p>Use of this connector under adverse environmental conditions may lead to discoloration or other kinds of degradation. Use of the connector in regions having exposure to excessive amounts of fine particles and dust, high densities of sulfur dioxide, hydrogen sulfide, nitrogen dioxide or other corrosive gasses (e.g., exhaust gas from automobiles or factories), is not advised.</p> <p>Environments having a large difference in temperature, such as a place near a heater.</p>
(2) Storage conditions	<p>Store the product in Hirose Electric's packaging or similar packaging conditions.</p> <p>Temperature: -10 to +40°C, humidity: 85% or less (recommended storage conditions)</p> <p>Use the product within six months from delivery.</p> <p>Products for which the storage period has expired must be tested for solderability before the use.</p>



## HIROSE ELECTRIC CO.,LTD.

6-3,Nakagawa Chuoh-2-Chome,Tsuzuki-Ku,Yokohama-Shi 224-8540,JAPAN  
 TEL: +81-45-620-3526 Fax: +81-45-591-3726  
<http://www.hirose.com>  
<http://www.hirose-connectors.com>